

***Nuvoton***  
***SMBus GPIO Controller***

W83L603G

W83L604G

Revision: 1.1      Date: July, 2008

W83L603G/W83L604G  
Datasheet Revision History

	PAGES	DATES	VERSION	WEB VERSION	MAIN CONTENTS
1	N.A.	Aug./06	1.0	1.0	Initial Version for customer
		July/08	1.1		Change logo

## Table of Contents-

1.	GENERAL DESCRIPTION .....	1
2.	FEATURES .....	1
2.1	General Features .....	1
2.2	Key Specifications .....	1
3.	PIN CONFIGURATION .....	2
4.	PIN DESCRIPTION.....	3
4.1	W83L603G .....	3
4.2	W83L604G .....	4
5.	ARCHITECTURE DESCRIPTION .....	5
6.	FUNCTION DESCRIPTIONS.....	10
6.1	Access Interface .....	10
6.1.1	Write a data into W83L603G/W83L604G register .....	10
6.1.2	Read a data from W83L603G/W83L604G register .....	10
6.2	GPI/O Application Mode: .....	11
6.2.1	GPO output.....	11
6.2.2	INT output.....	11
6.2.3	GPI interrupt status.....	11
7.	DC AND AC SPECIFICATION.....	12
7.1	Absolute Maximum Ratings .....	12
7.2	Power Supply Current Consumption .....	12
7.3	DC Characteristics .....	12
7.4	AC Characteristics.....	14
8.	PACKAGE DIMENSION OUTLINE.....	15
9.	ORDERING INFORMATION.....	18
10.	TOP MARKING SPECIFICATION .....	18
11.	TYPICAL APPLICATION CIRCUIT.....	19

## 1. GENERAL DESCRIPTION

The W83L603G & W83L604G are general purpose input/output ICs with SMBus™. W83L603G provides 8 GPI/O pins, W83L604G provides 14 GPI/O pins. W83L603G & W83L604G both provide SMBus™ address setting pins to set the address during power- on reset or from external reset.

W83L603G / W83L604G SMBus™ Address is:

0	0	1	1	A2	A1	A0	R/W
---	---	---	---	----	----	----	-----

W83L603G & W83L604G also provide an interrupt to inform system that a transition occurs on general purpose input pins. By W83L603G & W83L604G, flashing LED output and beep function are also supported. The part number with an affix of "G" is the Lead-free package product.

## 2. FEATURES

### 2.1 General Features

- SMBus™ Compliance with 3.3V Voltage Levels
- Flexible GPIO Pin Support, W83L603G Provides 8 pins, W83L604G Provides 14 pins.
- Interrupt Notification Support for System Event Occurs
- Support General Purpose Output Setting for Level or Pulse Mode
- Support Interrupt Output Setting for Level or Pulse mode
- Support Internal Power-on Reset or External RST# Pin Reset.
- Support Flashing LED Output
- Support PC Beep Output
- Chip Power down mode support
- 14-SOP Lead-free Package for W83L603G (RoHS Compliant)
- 20-SSOP Lead-free Package for W83L604G (RoHS Compliant)

### 2.2 Key Specifications

- Supply Voltage is 3.3V
- Operating Supply Current is 150 uA typ.
- Operating Temperature is from 0 °C to 70 °C

3. PIN CONFIGURATION

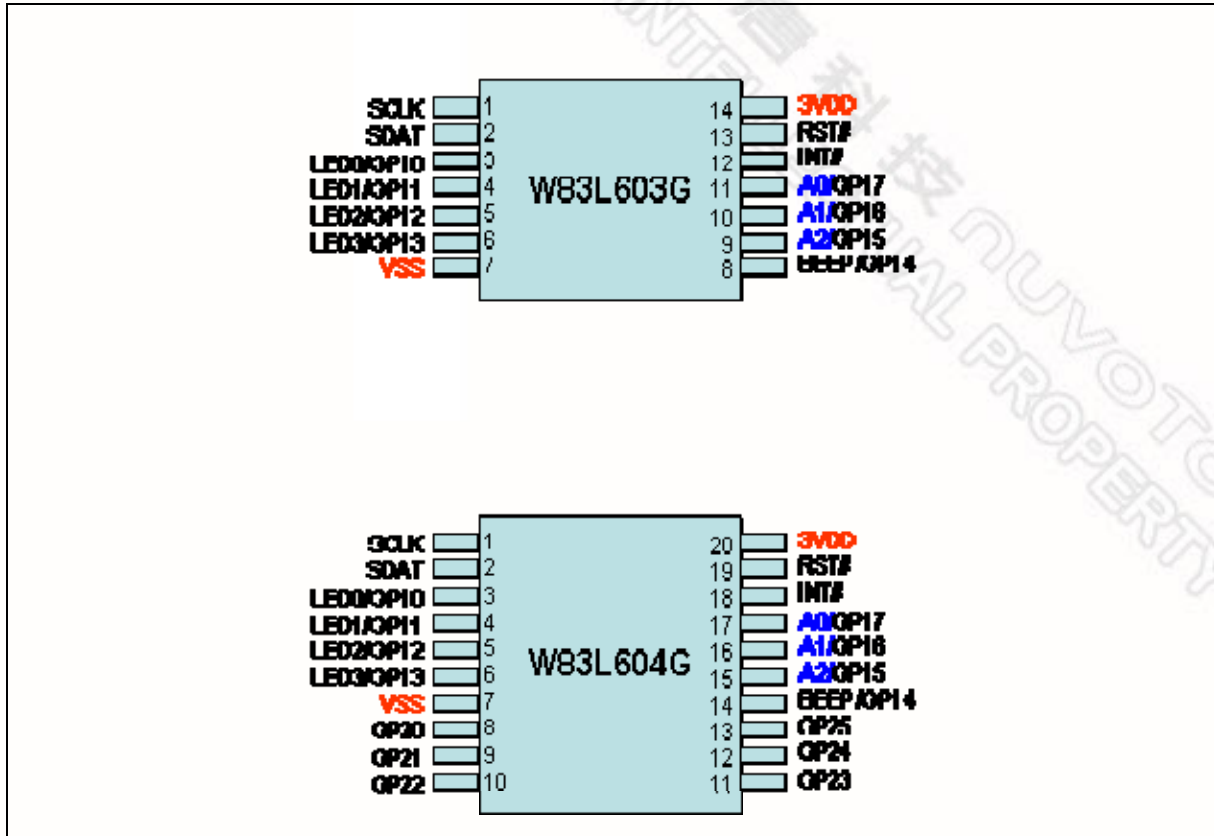

#### 4. PIN DESCRIPTION

IN <sub>ts</sub>	TTL level Schmitt-trigger input pin
I/OD <sub>12ts</sub>	TTL level bi-directional pin open drain output with 12 mA sink capability and schmitt-trigger level input
I/O <sub>12t</sub>	TTL level bi-directional pin bi-directional output with 12 mA source-sink capability
I/O(D) <sub>16t</sub>	TTL level bi-directional pin bi-directional (or open drain) output with 16 mA (source-) sink capability
I/O(D) <sub>12t</sub>	TTL level bi-directional pin bi-directional (or open drain) output with 12 mA (source-) sink capability
OD <sub>12</sub>	Open drain output pin with 12 mA sink capability

##### 4.1 W83L603G

PIN	SYMBOL	I/O	FUNCTION
1	SCL	IN <sub>ts</sub>	SMBus Clock.
2	SDA	I/OD <sub>12ts</sub>	SMBus bi-directional Data.
3	GP10/LED0	I/O(D) <sub>16t</sub>	General Purpose I/O. ; LED output
4	GP11/LED1	I/O(D) <sub>16t</sub>	General Purpose I/O. ; LED output
5	GP12/LED2	I/O(D) <sub>16t</sub>	General Purpose I/O. ; LED output
6	GP13/LED3	I/O(D) <sub>16t</sub>	General Purpose I/O. ; LED output
7	VSS	PWR	Power Pin.
8	GP14/BEEP	I/O(D) <sub>16t</sub>	General Purpose I/O. ; BEEP output
9	GP15 / A2	I/O <sub>12t</sub>	General Purpose I/O.; <b>Strapping pin for SMBus address bit 2, this pin is internal weak pull down during hardware reset.</b>
10	GP16 / A1	I/O <sub>12t</sub>	General Purpose I/O.; <b>Strapping pin for SMBus address bit 1, this pin is internal weak pull down during hardware reset.</b>
11	GP17 / A0	I/O <sub>12t</sub>	General Purpose I/O.; <b>Strapping pin for SMBus address bit 0, this pin is internal weak pull down during hardware reset.</b>
12	INT#	OD <sub>12</sub>	Auto-generated Interrupt signal when detecting a transition on GP inputs.
13	RST#	IN <sub>ts</sub>	System reset signal input. <b>Low level must be greater than 0.1uS.</b>
14	3VDD	PWR	Power Pin.

## 4.2 W83L604G

PIN	SYMBOL	I/O	FUNCTION
1	SCL	IN <sub>ts</sub>	SMBus Clock.
2	SDA	I/OD <sub>12ts</sub>	SMBus bi-directional Data.
3	GP10/LED0	I/O(D) <sub>16t</sub>	General Purpose I/O. ; LED output
4	GP11/LED1	I/O(D) <sub>16t</sub>	General Purpose I/O. ; LED output
5	GP12/LED2	I/O(D) <sub>16t</sub>	General Purpose I/O. ; LED output
6	GP13/LED3	I/O(D) <sub>16t</sub>	General Purpose I/O. ; LED output
7	VSS	PWR	Power Pin.
8	GP20	I/O(D) <sub>12t</sub>	General Purpose I/O.
9	GP21	I/O(D) <sub>12t</sub>	General Purpose I/O.
10	GP22	I/O(D) <sub>12t</sub>	General Purpose I/O.
11	GP23	I/O(D) <sub>12t</sub>	General Purpose I/O.
12	GP24	I/O(D) <sub>12t</sub>	General Purpose I/O.
13	GP25	I/O(D) <sub>12t</sub>	General Purpose I/O.
14	GP14/BEEP	I/O(D) <sub>16t</sub>	General Purpose I/O. ; BEEP output
15	GP15 / A2	I/O <sub>12t</sub>	General Purpose I/O.; <b>Strapping pin for SMBus address bit 2, this pin is internal weak pull down during hardware reset.</b>
16	GP16 / A1	I/O <sub>12t</sub>	General Purpose I/O.; <b>Strapping pin for SMBus address bit 1, this pin is internal weak pull down during hardware reset.</b>
17	GP17 / A0	I/O <sub>12t</sub>	General Purpose I/O.; <b>Strapping pin for SMBus address bit 0, this pin is internal weak pull down during hardware reset.</b>
18	INT#	OD <sub>12</sub>	Auto-generated Interrupt signal when detecting a transition on GP inputs.
19	RST#	IN <sub>ts</sub>	System reset signal input. <b>Low level must be greater than 0.1uS.</b>
20	3VDD	PWR	Power Pin.



## 5. ARCHITECTURE DESCRIPTION

### Register 00h – GP1 input port register

<b>BIT</b>	7	6	5	4	3	2	1	0
<b>R/W</b>	RO	RO	RO	RO	RO	RO	RO	RO

\*This register reflects the respective GPI1x pin level.

### Register 01h – GP1 output port register

<b>BIT</b>	7	6	5	4	3	2	1	0
<b>R/W</b>	RW	RW	RW	RW	RW	RW	RW	RW
<b>Default</b>	0	0	0	0	0	0	0	0

### Register 02h – GP1 Polarity Inversion register

<b>BIT</b>	7	6	5	4	3	2	1	0
<b>R/W</b>	RW	RW	RW	RW	RW	RW	RW	RW
<b>Default</b>	0	0	0	0	0	0	0	0

\*Refer to Section 6.2.1 for respective GPO1x pin type implementation.

### Register 03h – GP1 input/output configuration register

<b>BIT</b>	7	6	5	4	3	2	1	0
<b>R/W</b>	RW	RW	RW	RW	RW	RW	RW	RW
<b>Default</b>	1	1	1	1	1	1	1	1

\*This register configures the respective GPIO1x pin as input mode ("1"; by default) or output mode ("0").

### Register 04h – GP1 output style register

<b>BIT</b>	7	6	5	4	3	2	1	0
<b>R/W</b>	RW	RW	RW	RW	RW	RW	RW	RW
<b>Default</b>	0	0	0	0	0	0	0	0

\*This register configures the respective GPO1x pins as level ("0"; by default) or pulse ("1") output style.

\*Set output port register (CR01) to "0" before switch the output style to pulse mode.

### Register 05h – GP1 output mode register

<b>BIT</b>	7	6	5	4	3	2	1	0
<b>R/W</b>	RFU	RW	RW	RW	RW	RW	RW	RW
<b>Default</b>	0	0	0	0	0	0	0	0



Bit4-Bit0: Configures the respective GPO1x output pads function as Open-drain ("0"; by default) or Push-pull ("1") mode.

Bit6-5: GP14 / BEEP multi-function configuration register  
 =11, BEEP frequency = 4KHz; tone = 250 Hz.  
 =10, BEEP frequency = 2KHz; tone = 10 Hz.  
 =01, BEEP frequency = 1KHz / 500 Hz; tone= 1 Hz.  
 =00, BEEP function is disabled on GP14.

Bit7: Reserved for future use.

### Register 06h – GP1 interrupt control register

BIT	7	6	5	4	3	2	1	0
R/W	RW	RW	RW	RW	RW	RW	RW	RW
Default	0	0	0	0	0	0	0	0

\* This register configures the respective GP1x pin interrupt control as disable ("0"; by default) or enable ("1").

\*Clear interrupt status register (CR07) before set to enable.

### Register 07h – GP1 interrupt status register

BIT	7	6	5	4	3	2	1	0
R/W	R/clr	R/clr	R/clr	R/clr	R/clr	R/clr	R/clr	R/clr

\*The registers are read clear.

\*Refer to Section 6.2.3 for implementation.

### Register 08h – GP11-GP13 / LED multi-function configuration register

BIT	7	6	5	4	3	2	1	0
R/W	RW	RW	RW	RW	RW	RW	RW	RW
Default	0	0	0	0	0	0	0	0

Bit7-6: GP13 / LED multi-function configuration register

=11, GP13 functions LED output of 2Hz clock, 50% duty cycle.  
 =10, GP13 functions LED output of 1Hz clock, 50% duty cycle.  
 =01, GP13 functions LED output of 1/2 Hz clock, 50% duty cycle.  
 =00, LED function is disabled on GP13. (Default)

Bit5-4: GP12 / LED multi-function configuration register

=11, GP12 functions LED output of 2Hz clock, 50% duty cycle.  
 =10, GP12 functions LED output of 1Hz clock, 50% duty cycle.  
 =01, GP12 functions LED output of 1/2 Hz clock, 50% duty cycle.  
 =00, LED function is disabled on GP12. (Default)

Bit3-2: GP11 / LED multi-function configuration register

=11, GP11 functions LED output of 2Hz clock, 50% duty cycle.  
 =10, GP11 functions LED output of 1Hz clock, 50% duty cycle.  
 =01, GP11 functions LED output of 1/2 Hz clock, 50% duty cycle.  
 =00, LED function is disabled on GP11. (Default)

Bit1-0: GP10 / LED multi-function configuration register

=11, GP10 functions LED output of 2Hz clock, 50% duty cycle.  
 =10, GP10 functions LED output of 1Hz clock, 50% duty cycle.  
 =01, GP10 functions LED output of 1/2 Hz clock, 50% duty cycle.

=00, LED function is disabled on GP10. (Default)

#### Register 09h – GP1 input latch data register

BIT	7	6	5	4	3	2	1	0
R/W	RO	RO	RO	RO	RO	RO	RO	RO
Default	0	0	0	0	0	0	0	0

\*This register reflects the latch value of GP1x pins during hardware reset.

#### Register 10h – GP2 input port register (for W83L604G only)

BIT	7	6	5	4	3	2	1	0
R/W	NA		RO	RO	RO	RO	RO	RO

\*This register reflects the respective GPI2x pin level.

#### Register 11h – GP2 output port register (for W83L604G only)

BIT	7	6	5	4	3	2	1	0
R/W	NA		RW	RW	RW	RW	RW	RW
Default	NA		0	0	0	0	0	0

#### Register 12h – GP2 Polarity Inversion register (for W83L604G only)

BIT	7	6	5	4	3	2	1	0
R/W	NA		RW	RW	RW	RW	RW	RW
Default	NA		0	0	0	0	0	0

\*Refer to Section 6.2.1 for respective GPO2x pin type implementation.

#### Register 13h – GP2 input/output configuration register (for W83L604G only)

BIT	7	6	5	4	3	2	1	0
R/W	NA		RW	RW	RW	RW	RW	RW
Default	NA		1	1	1	1	1	1

\*This register configures the respective GPIO2x pin as input mode ("1"; by default) or output mode ("0").

#### Register 14h – GP2 output style register (for W83L604G only)

BIT	7	6	5	4	3	2	1	0
R/W	NA		RW	RW	RW	RW	RW	RW
Default	NA		0	0	0	0	0	0

\*This register configures the respective GPO2x pins as level ("0"; by default) or pulse ("1") output style.

\*Set output port register (CR11) to "0" before switch the output style to pulse mode.

**Register 15h – GP2 output mode register (for W83L604G only)**

BIT	7	6	5	4	3	2	1	0
R/W	NA		RW	RW	RW	RW	RW	RW
Default	NA		0	0	0	0	0	0

\*This register configures the respective GPO2x output pads function as **Open-drain** ("0"; by default) or **Push-pull** ("1") mode.

**Register 16h – GP2 interrupt control register (for W83L604G only)**

BIT	7	6	5	4	3	2	1	0
R/W	NA		RW	RW	RW	RW	RW	RW
Default	NA		0	0	0	0	0	0

\* This register configures the respective GPI2x pin interrupt control as disable ("0"; by default) or enable ("1").

\*Clear interrupt status register (CR17) before set to enable.

**Register 17h – GP2 interrupt status register (for W83L604G only)**

BIT	7	6	5	4	3	2	1	0
R/W	NA		R/clr	R/clr	R/clr	R/clr	R/clr	R/clr

\*The registers are read clear.

\*Refer to Section 6.2.3 for implementation.

**Register 20h – Chip ID (High byte; 95h for W83L604G, 96h for W83L603G)**

BIT	7	6	5	4	3	2	1	0
R/W	RO	RO	RO	RO	RO	RO	RO	RO
Default	1	0	0	1	0	1	0/1	1/0

**Register 21h – Chip ID (Low byte; 92h)**

BIT	7	6	5	4	3	2	1	0
R/W	RO	RO	RO	RO	RO	RO	RO	RO
Default	1	0	0	1	0	0	0	1

**Register 22h – Global configuration register**

BIT	7	6	5	4	3	2	1	0
R/W	WO	RFU	RW	RW	RW	RW	RW	RW
Default	0	0	0	0	0	0	0	0

Bit7: Write "1" to issue a software reset.

Bit6: Reserved for future use.

Bit5: Low power enable bit. The internal clock generator will shutdown while the bit is set. In the low-power mode, the functions of SMBus, LED, BEEP, and all signals configured as the pulse mode will NOT work.

Bit4: Wake-up enable. If the bit is set, low-power enable bit (Bit-5) can be cleared whenever interrupt event is triggered on GPI pin. To enable the interrupt control register (CR06,CR16) is necessary.

Bit3: Interrupt polarity bit. Refer to Section 7.2.2 for INT pin type implementation.

Bit2: This bit configures the INT signal output as level ("0"; by default) or pulse ("1") style.

Bit1: GP2 registers mask enable. Set "1" will mask the RST# signal for all GP2 registers. (10h ~ 17h)

Bit0: GP1 registers mask enable. Set "1" will mask the RST# signal for all GP1 registers. (00h ~ 08h)

\*Bit1 and Bit0 will not be reset by RST#.

## 6. FUNCTION DESCRIPTIONS

### 6.1 Access Interface

W83L603G/W83L604G provides a two-wired serial interface which is compliant with SMBus™ Write Byte and Read Byte protocol.

#### 6.1.1 Write a data into W83L603G/W83L604G register

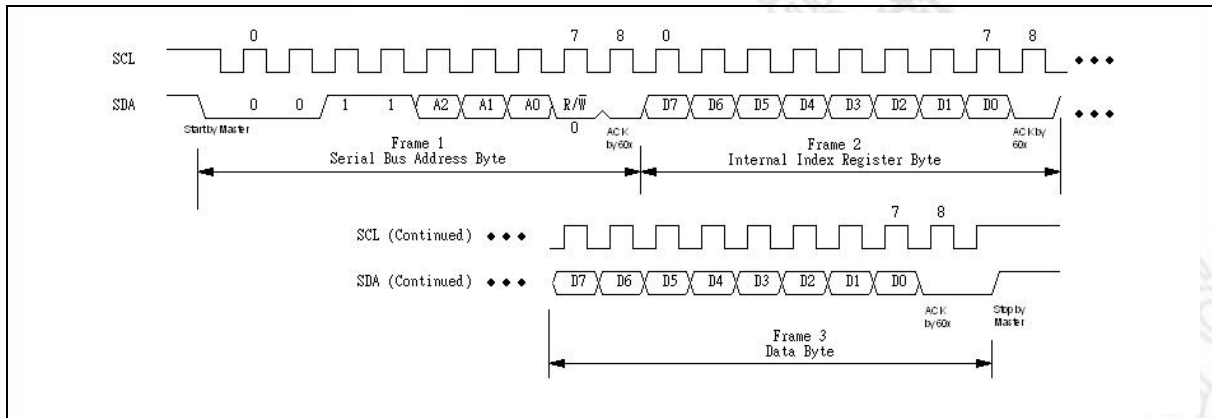



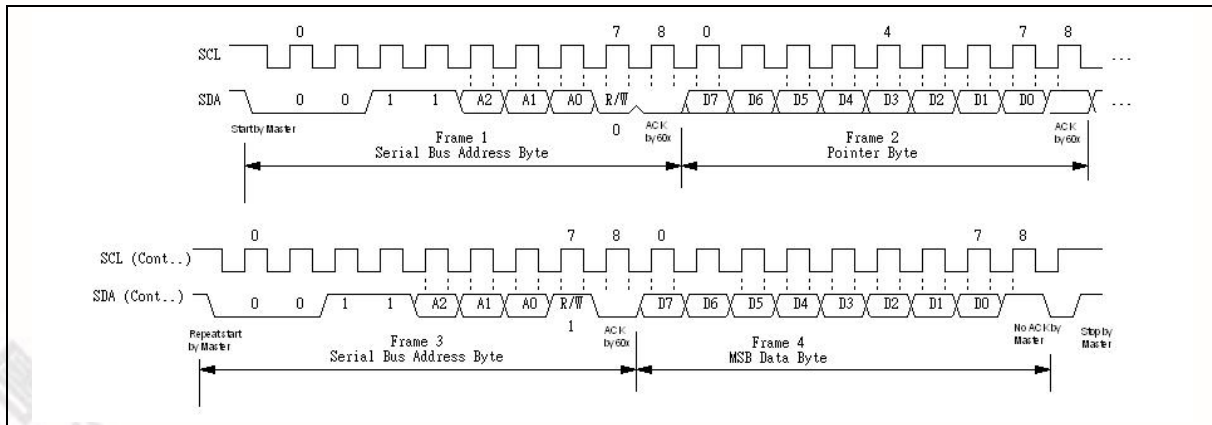



#### 6.1.2 Read a data from W83L603G/W83L604G register



## 6.2 GPI/O Application Mode:

### 6.2.1 GPO output





Take Reference Table for GPO Style and Polarity Function.

GPO OUTPUT STYLE	POLARITY	OUTPUT PORT REGISTER	OUTPUT VALUE AT PIN	WAVE
Level	0	0	0	
		1	1	
	1	0	1	
		1	0	
Pulse	0	Write 1	Active	
	1	Write 1	Active	

\*The GPO Pulse Mode output waveform width is 0.5uS.

### 6.2.2 INT output

Take Reference Table for INT Output Mode and Polarity Function.

INT OUTPUT MODE	POLARITY	OUTPUT	WAVE
Level	0	0	
	1	1	
Pulse	0	Low Pulse	
	1	High Pulse	

\*In Level mode, if INT is activated, it will be de-activated when interrupt status registers are read.

\*In Pulse mode, interrupt will be activated again unless all enabled interrupt status registers are read.

\*The INT Pulse Mode output waveform width is 0.25uS.

### 6.2.3 GPI interrupt status

Once a transition occurs at GPI input pins, interrupt status registers (CR07, CR17) will be set. At the mean time, if interrupt function is enable (CR06, CR16), the INT pin will generate an interrupt waveform. Reading these interrupt status registers will self clear and reset interrupt. If an interrupt occurs but never read the interrupt status registers, the interrupt will not be generated again.



## 7. DC AND AC SPECIFICATION

### 7.1 Absolute Maximum Ratings

PARAMETER	RATING	UNIT
Power Supply Voltage	$3.3 \pm 10\%$	V
Input Voltage	$3.3 \pm 10\%$	V
Operating Temperature	0 to +70	°C
Storage Temperature	-55 to +150	°C

**Note:** Exposure to conditions beyond those listed under Absolute Maximum Ratings may adversely affect the life and reliability of the device.

### 7.2 Power Supply Current Consumption

( $T_a = 0^\circ\text{C}$  to  $70^\circ\text{C}$ ,  $V_{DD} = 3.3\text{V} \pm 10\%$ ,  $V_{SS} = 0\text{V}$ )

PARAMETER	TYPICAL	UNIT
Normal Mode	150	$\mu\text{A}$
Power Down Mode	10	$\mu\text{A}$

**Note:** The Typical value is measured by whole GPIO pins output without load.

### 7.3 DC Characteristics

( $T_a = 0^\circ\text{C}$  to  $70^\circ\text{C}$ ,  $V_{DD} = 3.3\text{V} \pm 10\%$ ,  $V_{SS} = 0\text{V}$ )

IN <sub>ts</sub> - TTL level schmitt-trigger input pin						
PARAMETER	SYM.	MIN.	TYP.	MAX.	UNIT	CONDITIONS
Input Low Voltage	$V_{IL}$			0.8	V	$V_{DD} = 3.3\text{V}$
Input High Voltage	$V_{IH}$	2.0			V	$V_{DD} = 3.3\text{V}$
Input High Leakage	$I_{L\text{IH}}$			+10	$\mu\text{A}$	$V_{IN} = V_{DD}$
Input Low Leakage	$I_{L\text{IL}}$			-10	$\mu\text{A}$	$V_{IN} = 0\text{V}$
I/OD <sub>12ts</sub> - TTL level bi-direction pin with 12mA sink capability and schmitt-trigger input						
Input Low Voltage	$V_{IL}$			0.8	V	$V_{DD} = 3.3\text{V}$
Input High Voltage	$V_{IH}$	2.0			V	$V_{DD} = 3.3\text{V}$
Output Low Voltage	$V_{OL}$			0.4	V	$I_{OL} = 12\text{mA}$
Input High Leakage	$I_{L\text{IH}}$			+10	$\mu\text{A}$	$V_{IN} = V_{DD}$
Input Low Leakage	$I_{L\text{IL}}$			-10	$\mu\text{A}$	$V_{IN} = 0\text{V}$



DC Characteristics , continued.

<b>I/O<sub>12t</sub> - TTL level bi-direction pin with 12mA source-sink capability</b>						
Input Low Voltage	V <sub>IL</sub>			0.8	V	V <sub>DD</sub> = 3.3 V
Input High Voltage	V <sub>IH</sub>	2.0			V	V <sub>DD</sub> = 3.3 V
Output Low Voltage	V <sub>OL</sub>			0.4	V	I <sub>OL</sub> = 12 mA
Output High Voltage	V <sub>OH</sub>	2.4			V	I <sub>OH</sub> = 12 mA
Input High Leakage	I <sub>LIH</sub>			+15	μA	V <sub>IN</sub> = 3.3 V
Input Low Leakage	I <sub>LIL</sub>			-15	μA	V <sub>IN</sub> = 0 V
<b>I/O(D)<sub>16t</sub> - TTL level bi-direction pin with 16mA source-sink capability</b>						
Input Low Voltage	V <sub>IL</sub>			0.8	V	V <sub>DD</sub> = 3.3 V
Input High Voltage	V <sub>IH</sub>	2.0			V	V <sub>DD</sub> = 3.3 V
Output Low Voltage	V <sub>OL</sub>			0.4	V	I <sub>OL</sub> = 16 mA
Output High Voltage	V <sub>OH</sub>	2.4			V	I <sub>OH</sub> = 16 mA
Input High Leakage	I <sub>LIH</sub>			+10	μA	V <sub>IN</sub> = 3.3 V
Input Low Leakage	I <sub>LIL</sub>			-10	μA	V <sub>IN</sub> = 0 V
<b>I/O(D)<sub>12t</sub> - TTL level bi-direction pin with 12mA source-sink capability</b>						
Input Low Voltage	V <sub>IL</sub>			0.8	V	V <sub>DD</sub> = 3.3 V
Input High Voltage	V <sub>IH</sub>	2.0			V	V <sub>DD</sub> = 3.3 V
Output Low Voltage	V <sub>OL</sub>			0.4	V	I <sub>OL</sub> = 12 mA
Output High Voltage	V <sub>OH</sub>	2.4			V	I <sub>OH</sub> = 12 mA
Input High Leakage	I <sub>LIH</sub>			+10	μA	V <sub>IN</sub> = 3.3 V
Input Low Leakage	I <sub>LIL</sub>			-10	μA	V <sub>IN</sub> = 0 V
<b>OD<sub>12</sub> - open-drain output pin with 12mA sink capability</b>						
Output Low Voltage	V <sub>OL</sub>			0.4	V	I <sub>OL</sub> = 12 mA

## 7.4 AC Characteristics

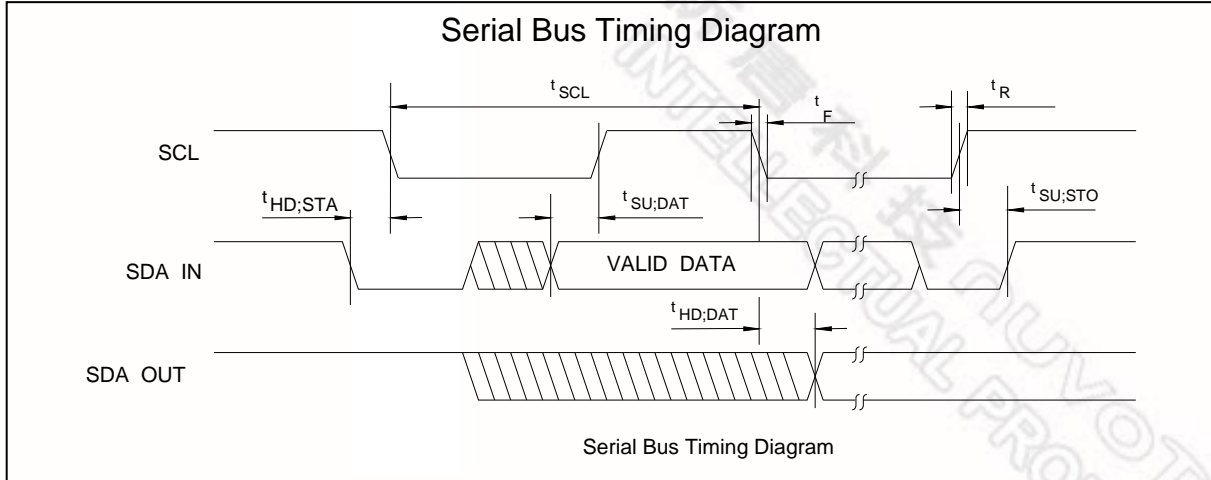

Serial Bus Timing

PARAMETER	SYMBOL	MIN.	MAX.	UNIT
SCL clock period	$t_{SCL}$	10		uS
Start condition hold time	$t_{HD;STA}$	4.7		uS
Stop condition setup-up time	$t_{SU;STO}$	4.7		uS
DATA to SCL setup time	$t_{SU;DAT}$	120		nS
DATA to SCL hold time	$t_{HD;DAT}$	5		nS
SCL and SDA rise time	$t_R$		1.0	uS
SCL and SDA fall time	$t_F$		300	nS

## 8. PACKAGE DIMENSION OUTLINE

Nuvoton provides two packages for customers thank contain 14-SOP and 20-SSOP.

14L SOP-150mil for W83L603G

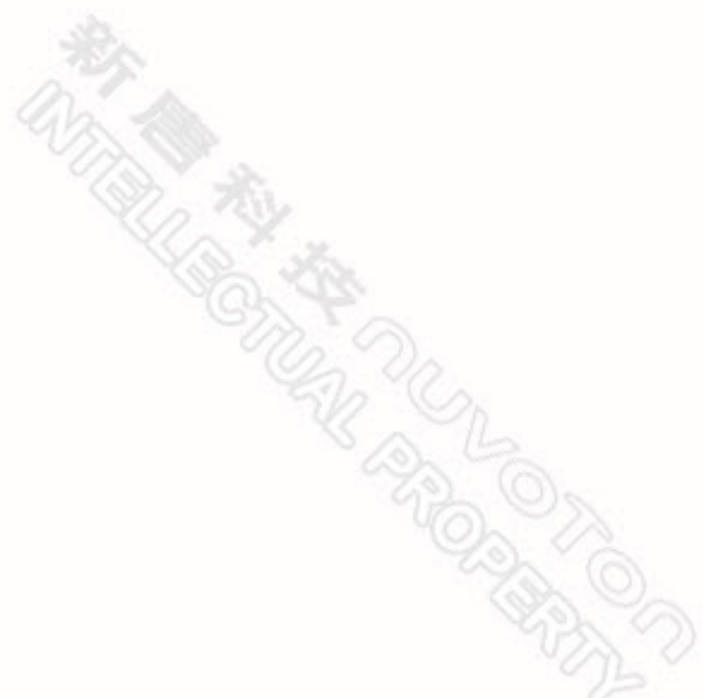
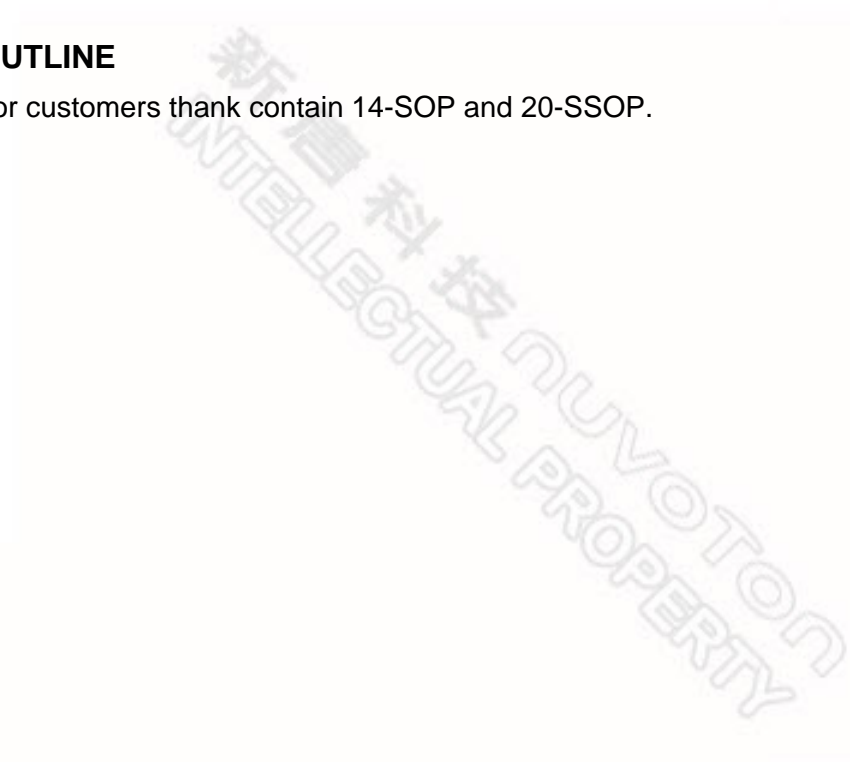

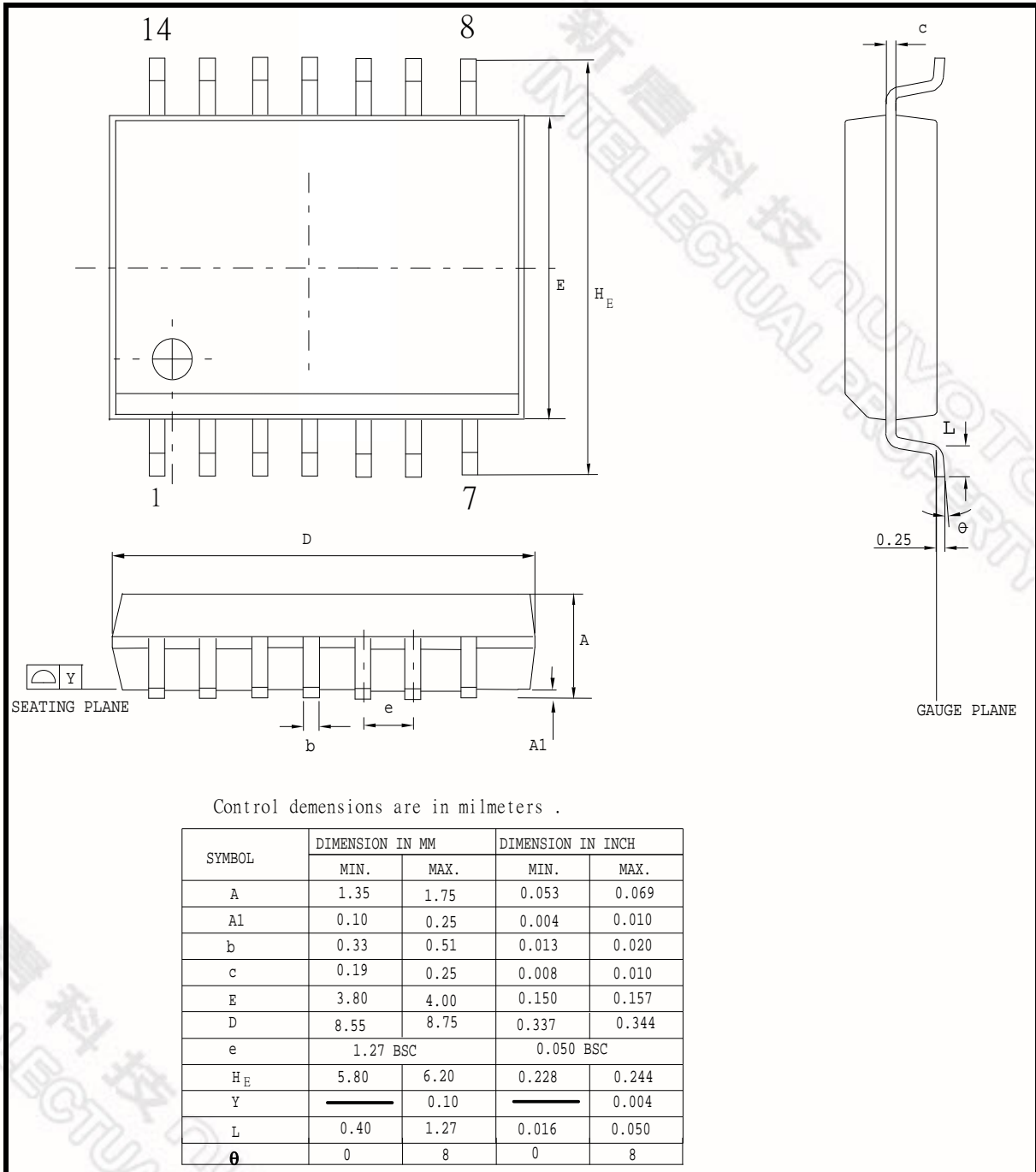

20L SSOP-209mil for W83L604G

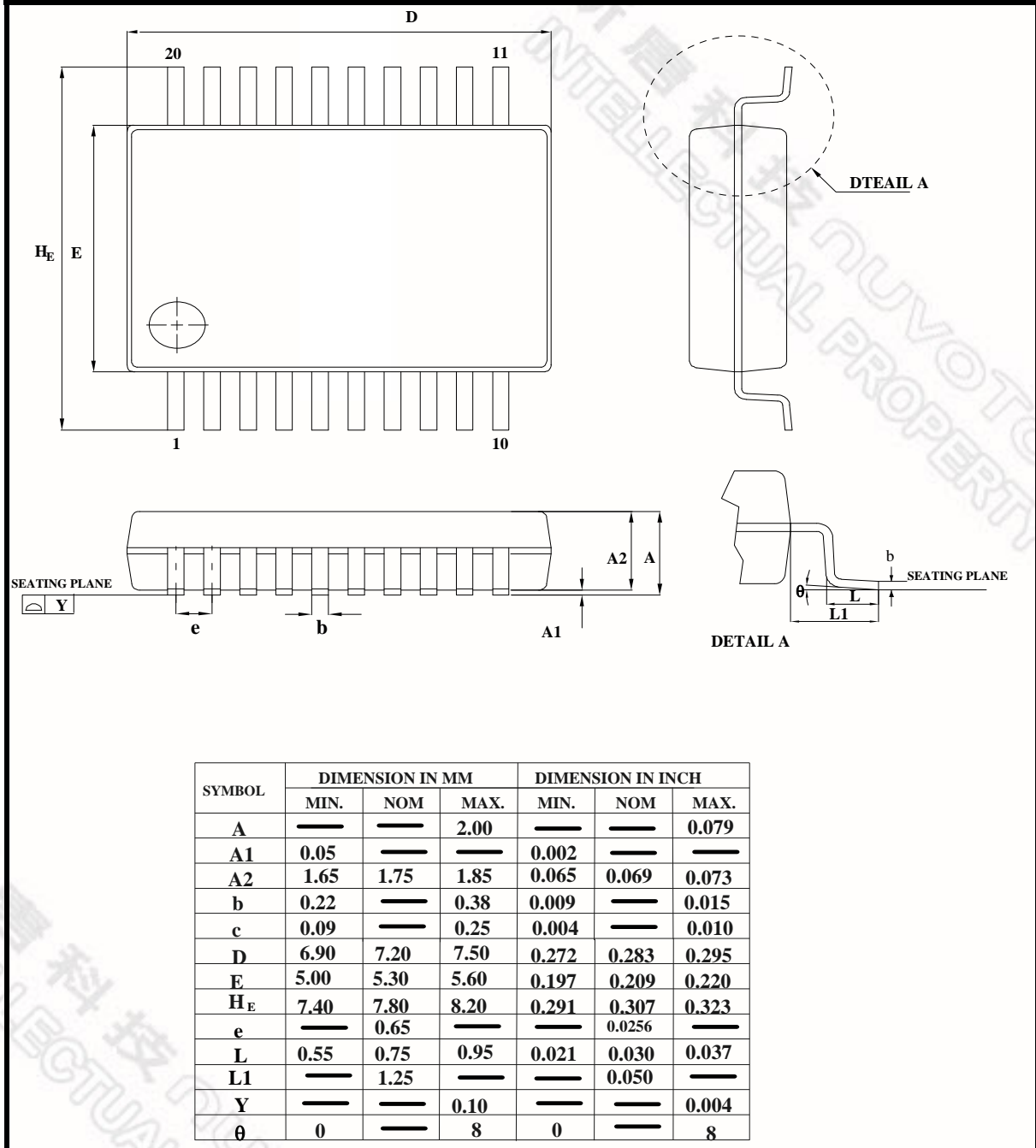

## 9. ORDERING INFORMATION

PART NUMBER	PACKAGE TYPE	PRODUCTION FLOW
W83L603G	14-SOP (Leadfree)	Commercial, 0°C to +70°C
W83L604G	20-SSOP (Leadfree)	Commercial, 0°C to +70°C

## 10. TOP MARKING SPECIFICATION

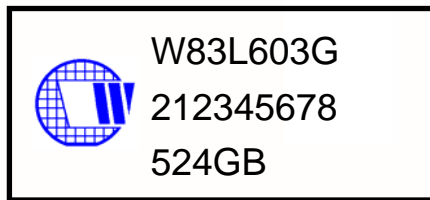

Left line: Chip logo

1<sup>st</sup> line: W83L603G – the part number for Lead-free product

2<sup>nd</sup> line: Chip lot no

3<sup>rd</sup> line: Tracking code 524 G B

**524**: packages assembled in Year 05', week 24

**G**: assembly house ID

**B**: the IC version

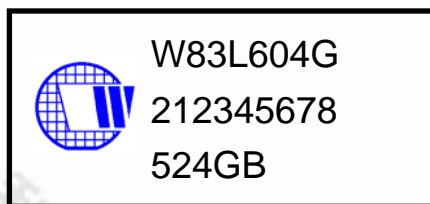

Left line: Chip logo

1<sup>st</sup> line: W83L604G – the part number for Lead-free product

2<sup>nd</sup> line: Chip lot no

3<sup>rd</sup> line: Tracking code 524 G B

**524**: packages assembled in Year 05', week 24

**G**: assembly house ID

**B**: the IC version

11. TYPICAL APPLICATION CIRCUIT

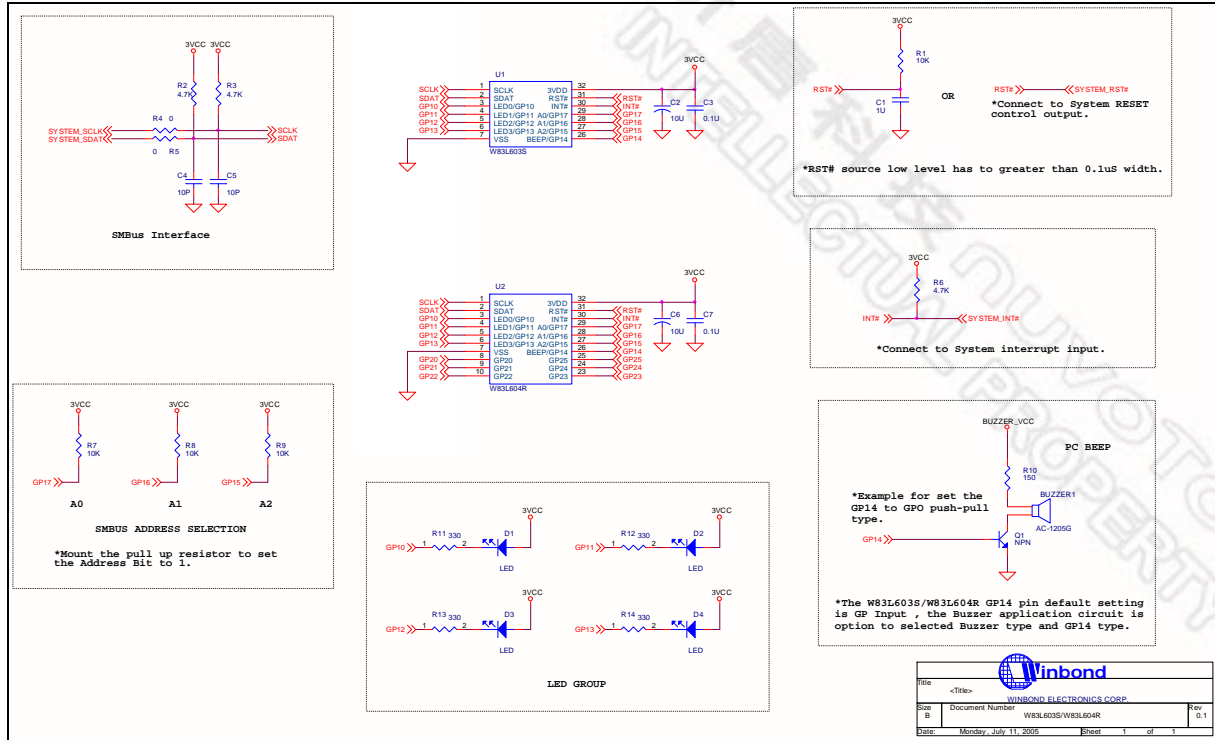

新唐科技 NUVOTON  
INTELLECTUAL PROPERTY



### Important Notice

Nuvoton products are not designed, intended, authorized or warranted for use as components in systems or equipment intended for surgical implantation, atomic energy control instruments, airplane or spaceship instruments, transportation instruments, traffic signal instruments, combustion control instruments, or for other applications intended to support or sustain life. Furthermore, Nuvoton products are not intended for applications wherein failure of Nuvoton products could result or lead to a situation wherein personal injury, death or severe property or environmental damage could occur.

Nuvoton customers using or selling these products for use in such applications do so at their own risk and agree to fully indemnify Nuvoton for any damages resulting from such improper use or sales.

---

Please note that all data and specifications are subject to change without notice.  
All the trademarks of products and companies mentioned in this datasheet belong to their respective owners.

*Publication Release Date: July, 2008  
Revision 1.1*