

# RICOH

## R1200x SERIES

### STEP-UP DC/DC CONVERTER FOR OLED BACK LIGHT with SHUTDOWN FUNCTION

NO.EA-192-170925

#### OUTLINE

R1200x series are CMOS-based control type step-up DC/DC converter with low supply current ICs. Each of these ICs consists of a Nch MOSFET, NPN transistor, an oscillator, PWM comparator, a voltage reference unit, an error amplifier, a current limit circuit, an under voltage lockout circuit (UVLO), an over voltage protection circuit (OVP), and a soft start circuit. As the external components, an inductor, resistances or capacitors are necessary to make a constant output voltage of step-up DC/DC converter with the R1200x. At standby mode, the NPN transistor can separate the output from the input. During the situation of that, there are two versions. R1200xxxxA: the output of  $V_{OUT}$  is generated to 0V by the low resistance (with the auto discharge function). R1200xxxxB does not generate the output of  $V_{OUT}$  (without the auto discharge function).

The soft-start time (Typ. 1.5ms) and the maximum duty cycle (Typ. 91%) are set internally. For the protection functions of R1200x series are the current limit function of the  $L_x$  peak current, the OVP function for detection the over voltage of output and the UVLO function for protective miss-operation by the low voltage. (The threshold of OVP is selectable from 17V, 19V or 21V.)

Since the packages for these ICs are DFN1616-6, DFN(PLP)1820-6, SOT-23-6 and WLCSP-6-P1, therefore high density mounting of the ICs on boards is possible.

#### FEATURES

- Supply Current ..... Typ. 500 $\mu$ A
- Standby Current ..... Max. 3 $\mu$ A
- Input Voltage Range ..... 2.3V to 5.5V
- Feedback Voltage ..... 1.0V (Externally adjustable)
- Feedback Voltage Accuracy .....  $\pm 1.5\%$
- Temperature-Drift Coefficient of Feedback Voltage .....  $\pm 150$ ppm/ $^{\circ}$ C
- Oscillator Frequency ..... Typ. 1.2MHz
- Maximum Duty Cycle ..... Typ. 91%
- Switch ON Resistance ..... Typ. 1.35 $\Omega$
- UVLO Detector Threshold ..... Typ. 2.0V
- Soft-start Time ..... Typ. 1.5ms
- $L_x$  Current Limit Protection ..... Typ. 700mA
- OVP Detector Threshold ..... 17V, 19V, 21V
- Switching Control ..... PWM
- Built-in a rectifier NPN transistor, at standby mode, complete shutdown is possible.
- Built-in Auto discharge function ..... A version
- Packages ..... DFN1616-6, DFN(PLP)1820-6, SOT-23-6,  
WLCSP-6-P1
- Ceramic capacitors are recommended ..... 1 $\mu$ F

#### APPLICATION

- OLED power supply for portable equipment
- White LED Backlight for portable equipment

R1200Z (WLCSP-6-P1) is the discontinued product as of September 2017.  
R1200K (DFN(PLP)1820-6) is the non-promotional product as of March 2019.

---

## R1200x

NO.EA-192-170925

---

### SELECTION GUIDE

The OVP threshold voltage, auto discharge function, and the package for the ICs can be selected at the user's request.

Product Name	Package	Quantity per Reel	Pb Free	Halogen Free
R1200Zxxx*-E2-F	WLCSP-6-P1	5,000 pcs	Yes	Yes
R1200Lxxx*-TR	DFN1616-6	5,000 pcs	Yes	Yes
R1200Kxxx*-TR	DFN(PLP)1820-6	5,000 pcs	Yes	Yes
R1200Nxxx*-TR-FE	SOT-23-6	3,000 pcs	Yes	Yes
xxx : Designation of OVP detector threshold (001) 17V threshold of OVP (002) 19V threshold of OVP (003) 21V threshold of OVP				
* : The auto discharge function at off state are options as follows. (A) with auto discharge function at off state (B) without auto discharge function at off state				

## BLOCK DIAGRAMS

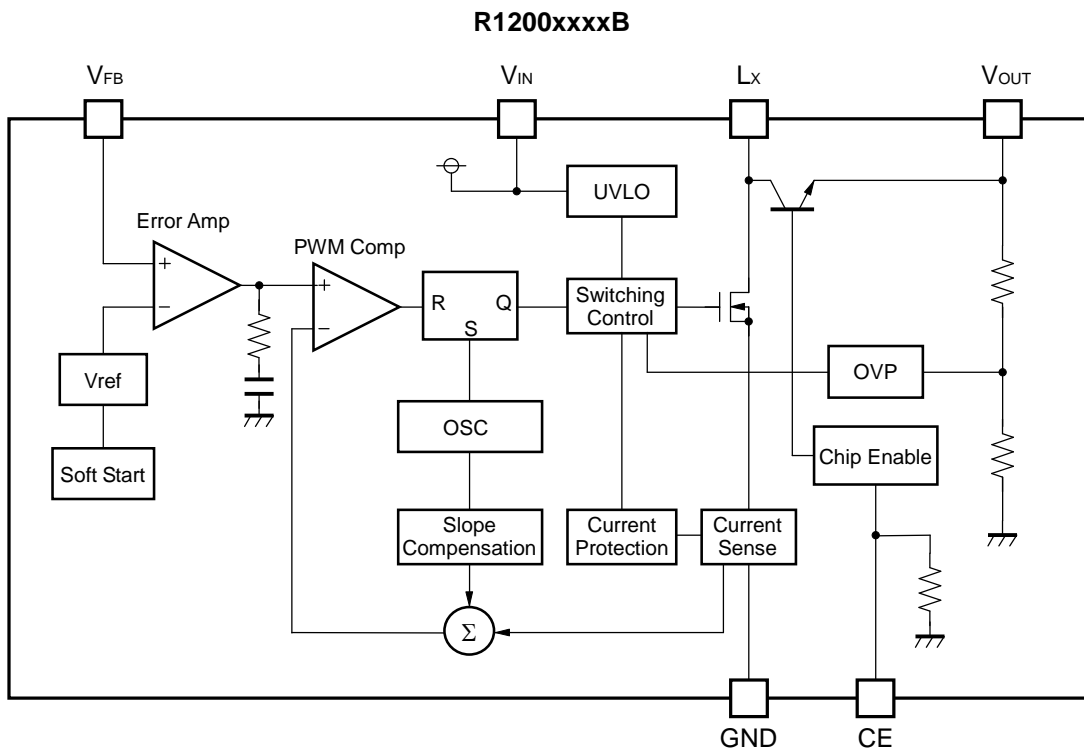
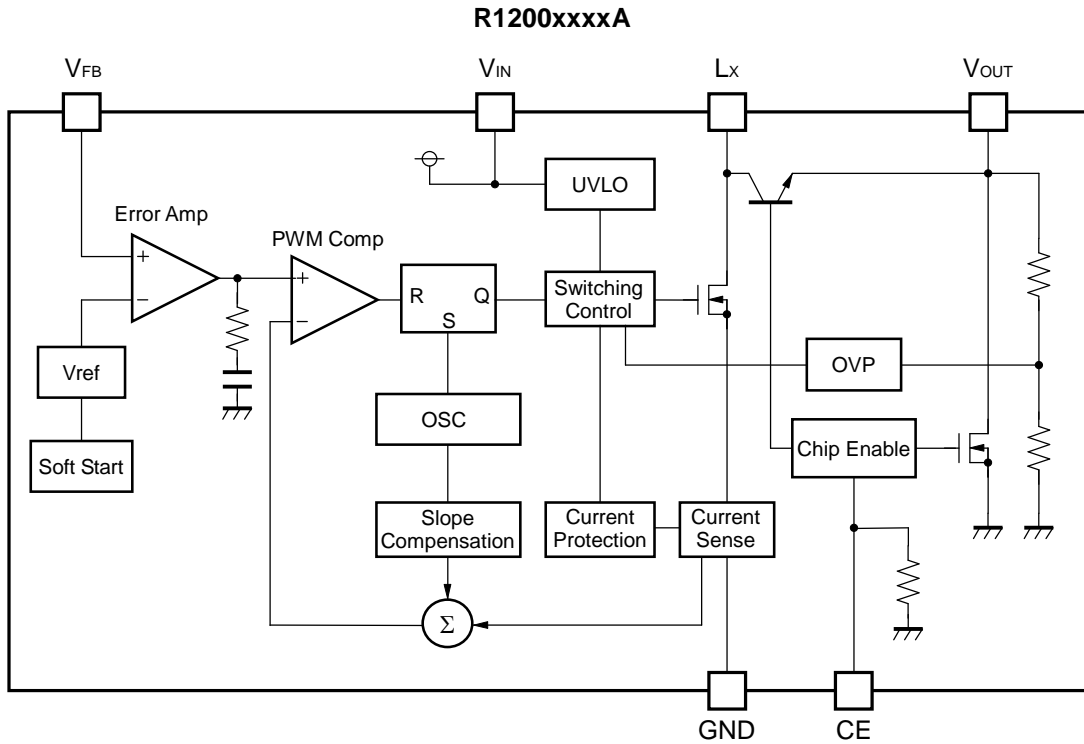

R1200Z (WLCSP-6-P1) is the discontinued product as of September 2017.  
R1200K (DFN(PLP)1820-6) is the non-promotional product as of March 2019.

## R1200x

NO.EA-192-170925

## PIN DESCRIPTIONS

WLCSP-6-P1

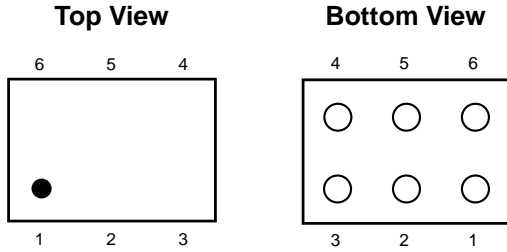

DFN1616-6

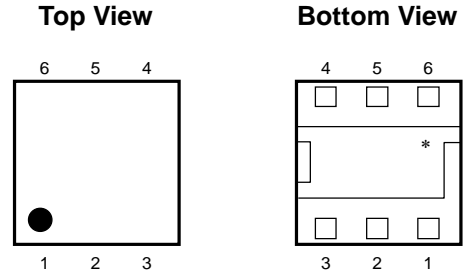

DFN(PLP)1820-6

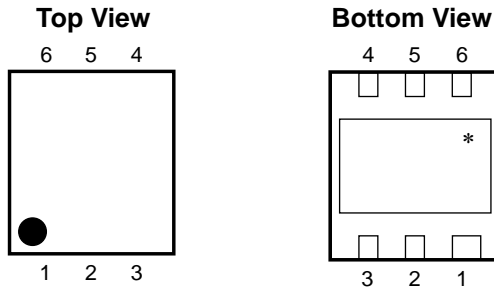

SOT-23-6

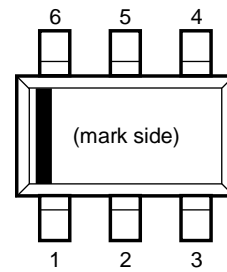

### • WLCSP-6-P1

Pin No	Symbol	Pin Description
1	LX	Switching Pin (Open Drain Output)
2	V <sub>IN</sub>	Power Supply Input Pin
3	V <sub>FB</sub>	Feedback Pin
4	CE	Chip Enable Pin ("H" Active)
5	V <sub>OUT</sub>	Output Pin
6	GND	Ground Pin

### • DFN1616-6, DFN(PLP)1820-6

Pin No	Symbol	Pin Description
1	CE	Chip Enable Pin ("H" Active)
2	V <sub>FB</sub>	Feedback Pin
3	LX	Switching Pin (Open Drain Output)
4	GND	Ground Pin
5	V <sub>DD</sub>	Input Pin
6	V <sub>OUT</sub>	Output Pin

\*) Tab is GND level. (They are connected to the reverse side of this IC.)  
The tab is better to be connected to the GND, but leaving it open is also acceptable.

R1200Z (WLCSP-6-P1) is the discontinued product as of September 2017.  
R1200K (DFN(PLP)1820-6) is the non-promotional product as of March 2019.

---

**R1200x**

NO.EA-192-170925

• **SOT-23-6**

<b>Pin No</b>	<b>Symbol</b>	<b>Pin Description</b>
1	CE	Chip Enable Pin ("H" Active)
2	V <sub>OUT</sub>	Output Pin
3	V <sub>DD</sub>	Input Pin
4	Lx	Switching Pin (Open Drain Output)
5	GND	Ground Pin
6	V <sub>FB</sub>	Feedback Pin

R1200Z (WLCSP-6-P1) is the discontinued product as of September 2017.  
R1200K (DFN(PLP)1820-6) is the non-promotional product as of March 2019.

## R1200x

NO.EA-192-170925

### ABSOLUTE MAXIMUM RATINGS

(GND=0V)

Symbol	Item		Rating	Unit	
V <sub>IN</sub>	V <sub>IN</sub> Pin Voltage		-0.3 to 6.5	V	
V <sub>CE</sub>	CE Pin Voltage		-0.3 to V <sub>IN</sub> +0.3	V	
V <sub>FB</sub>	V <sub>FB</sub> Pin Voltage		-0.3 to V <sub>IN</sub> +0.3	V	
V <sub>OUT</sub>	V <sub>OUT</sub> Pin Voltage		-0.3 to 25.0	V	
V <sub>LX</sub>	L <sub>X</sub> Pin Voltage		-0.3 to 25.0	V	
I <sub>LX</sub>	L <sub>X</sub> Pin Current		1000	mA	
P <sub>D</sub>	Power Dissipation*	Standard Test Land Pattern	WLCSP-6-P1	633	mW
		JEDEC STD. 51-7 Test Land Pattern	DFN1616-6	2400	
			DFN(PLP)1820-6	2200	
			SOT-23-6	660	
T <sub>j</sub>	Junction Temperature Range		-40 to 125	°C	
T <sub>stg</sub>	Storage Temperature Range		-55 to 125	°C	

\*) For Power Dissipation, please refer to *POWER DISSIPATION*.

#### ABSOLUTE MAXIMUM RATINGS

Electronic and mechanical stress momentarily exceeded absolute maximum ratings may cause the permanent damages and may degrade the life time and safety for both device and system using the device in the field. The functional operation at or over these absolute maximum ratings is not assured.

### RECOMMENDED OPERATING CONDITIONS

Symbol	Item	Rating	Unit
V <sub>IN</sub>	Input Voltage	2.3 to 5.5	V
T <sub>a</sub>	Operating Temperature Range	-40 to 85	°C

#### RECOMMENDED OPERATING CONDITIONS

All of electronic equipment should be designed that the mounted semiconductor devices operate within the recommended operating conditions. The semiconductor devices cannot operate normally over the recommended operating conditions, even if when they are used over such ratings by momentary electronic noise or surge. And the semiconductor devices may receive serious damage when they continue to operate over the recommended operating conditions.

## ELECTRICAL CHARACTERISTICS

• R1200x

Ta=25°C

Symbol	Item	Conditions	Min.	Typ.	Max.	Unit	
I <sub>DD</sub>	Supply Current	V <sub>IN</sub> =5.5V, V <sub>FB</sub> =0V, Lx at no load		0.5	1.0	mA	
I <sub>standby</sub>	Standby Current	V <sub>IN</sub> =5.5V, V <sub>CE</sub> =0V		0	3.0	μA	
V <sub>UVLO1</sub>	UVLO Detector Threshold	V <sub>IN</sub> falling	1.9	2.0	2.1	V	
V <sub>UVLO2</sub>	UVLO Released Voltage	V <sub>IN</sub> rising		V <sub>UVLO1</sub> +0.10	2.25	V	
V <sub>CEH</sub>	CE Input Voltage "H"	V <sub>IN</sub> =5.5V	1.5			V	
V <sub>CEL</sub>	CE Input Voltage "L"	V <sub>IN</sub> =2.3V			0.5	V	
R <sub>CE</sub>	CE Pull Down Resistance	V <sub>IN</sub> =3.6V	600	1200	2200	kΩ	
V <sub>FB</sub>	V <sub>FB</sub> Voltage Accuracy	V <sub>IN</sub> =3.6V	0.985	1.0	1.015	V	
ΔV <sub>FB</sub> / ΔTa	V <sub>FB</sub> Voltage Temperature Coefficient	V <sub>IN</sub> =3.6V, -40°C ≤ Ta ≤ 85°C		±150		ppm/°C	
I <sub>FB</sub>	V <sub>FB</sub> Input Current	V <sub>IN</sub> =5.5V, V <sub>FB</sub> =0V or 5.5V	-0.1		0.1	μA	
t <sub>start</sub>	Soft-start Time	V <sub>IN</sub> =3.6V		1.5		ms	
R <sub>ON</sub>	Switch ON Resistance	V <sub>IN</sub> =3.6V, I <sub>SW</sub> =100mA		1.35		Ω	
I <sub>LXleak</sub>	Switch Leakage Current			0	3.0	μA	
I <sub>LXlim</sub>	Switch Current Limit	V <sub>IN</sub> =3.6V	400	700	1000	mA	
V <sub>NPN</sub>	NPN V <sub>CE</sub> Voltage	I <sub>NPN</sub> =100mA		0.8		V	
I <sub>NPNOFF1</sub>	NPN Leakage Current 1	V <sub>OUT</sub> =23V			10	μA	
I <sub>NPNOFF2</sub>	NPN Leakage Current 2	V <sub>OUT</sub> =0V, V <sub>LX</sub> =5.5V			3.0	μA	
f <sub>osc</sub>	Oscillator Frequency	V <sub>IN</sub> =3.6V, V <sub>OUT</sub> =V <sub>FB</sub> =0V	1.0	1.2	1.4	MHz	
Maxduty	Maximum Duty Cycle	V <sub>IN</sub> =3.6V, V <sub>OUT</sub> =V <sub>FB</sub> =0V	86	91		%	
V <sub>OVP1</sub>	OVP Detector Threshold	V <sub>IN</sub> =3.6V, V <sub>OUT</sub> rising	R1200x001x	16	17	18	V
			R1200x002x	18	19	20	
			R1200x003x	20	21	22	
V <sub>OVP2</sub>	OVP Released Voltage	V <sub>IN</sub> =3.6V, V <sub>OUT</sub> falling		V <sub>OVP1</sub> -1.1		V	
I <sub>DISCHG</sub>	V <sub>OUT</sub> Discharge Current	V <sub>IN</sub> =3.6V, V <sub>OUT</sub> =0.1V	R1200xxxxA	0.7		mA	
I <sub>VOUT</sub>	OVP Sense Current	V <sub>IN</sub> =3.6V, V <sub>OUT</sub> =23V		6.0		μA	

**R1200x**

NO.EA-192-170925

**OPERATING DESCRIPTIONS**

**Operation of Step-Up DC/DC Converter and Output Current**

**<Basic Circuit>**

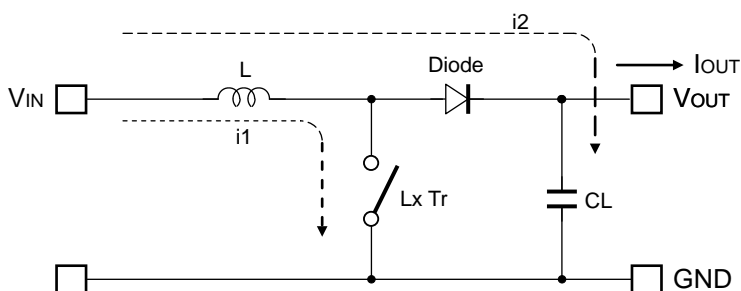

**<Current through L>**

**Discontinuous mode**

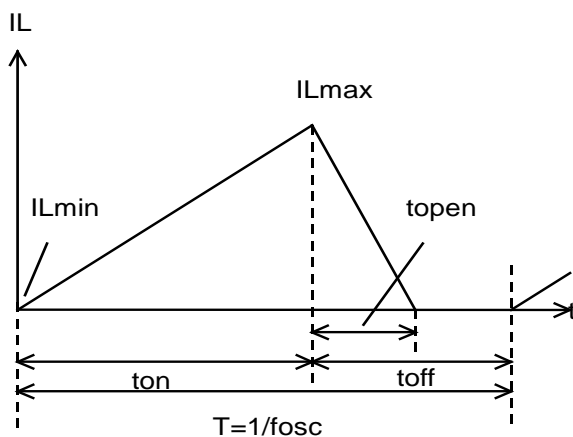

**Continuous mode**

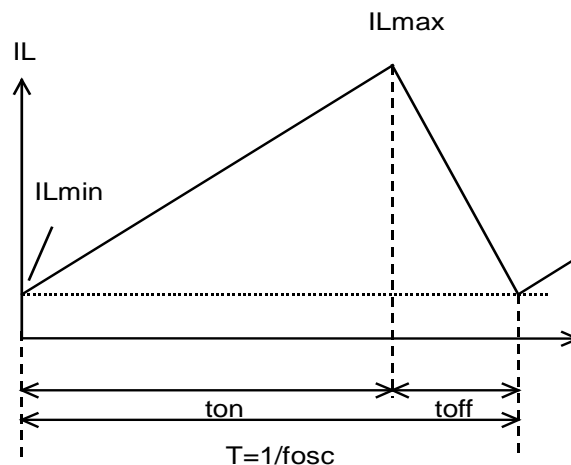

There are two operation modes of the step-up PWM control-DC/DC converter. That is the continuous mode and discontinuous mode by the continuousness inductor.

When the transistor turns ON, the voltage of inductor L becomes equal to  $V_{IN}$  voltage. The increase value of inductor current ( $i_1$ ) will be

$$\Delta i_1 = V_{IN} \times t_{on} / L \dots\dots\dots \text{Formula 1}$$



As the step-up circuit, during the OFF time (when the transistor turns OFF) the voltage is continually supply from the power supply. The decrease value of inductor current ( $i_2$ ) will be

$$\Delta i_2 = (V_{OUT} - V_{IN}) \times t_{open} / L \dots\dots\dots \text{Formula 2}$$

At the PWM control-method, the inductor current become continuously when  $t_{open}=t_{off}$ , the DC/DC converter operate as the continuous mode.

In the continuous mode, the variation of current of  $i_1$  and  $i_2$  is same at regular condition.

$$V_{IN} \times t_{on} / L = (V_{OUT} - V_{IN}) \times t_{off} / L \dots\dots\dots \text{Formula 3}$$

The duty at continuous mode will be

$$\text{duty (\%)} = t_{on} / (t_{on} + t_{off}) = (V_{OUT} - V_{IN}) / V_{OUT} \dots\dots\dots \text{Formula 4}$$

The average of inductor current at  $t_f = t_{off}$  will be

$$I_{L(Ave.)} = V_{IN} \times t_{on} / (2 \times L) \dots\dots\dots \text{Formula 5}$$

If the input voltage = output voltage, the  $I_{OUT}$  will be

$$I_{OUT} = V_{IN}^2 \times t_{on} / (2 \times L \times V_{OUT}) \dots\dots\dots \text{Formula 6}$$

If the  $I_{OUT}$  value is large than above the calculated value (Formula 6), it will become the continuous mode, at this status, the peak current ( $I_{Lmax}$ ) of inductor will be

$$I_{Lmax} = I_{OUT} \times V_{OUT} / V_{IN} + V_{IN} \times t_{on} / (2 \times L) \dots\dots\dots \text{Formula 7}$$

$$I_{Lmax} = I_{OUT} \times V_{OUT} / V_{IN} + V_{IN} \times T \times (V_{OUT} - V_{IN}) / (2 \times L \times V_{OUT}) \dots\dots\dots \text{Formula 8}$$

The peak current value is larger than the  $I_{OUT}$  value. In case of this, selecting the condition of the input and the output and the external components by considering of  $I_{Lmax}$  value.

The explanation above is based on the ideal calculation, and the loss caused by  $L_x$  switch and the external components are not included.

The actual maximum output current will be between 50% and 80% by the above calculations. Especially, when the  $I_L$  is large or  $V_{IN}$  is low, the loss of  $V_{IN}$  is generated with on resistance of the switch. Moreover, it is necessary to consider  $V_f$  of the diode (approximately 0.8V) about  $V_{OUT}$ .

## R1200x

NO.EA-192-170925

### ● Shutdown

- At standby mode, the output is completely separated from the input and shutdown by the NPN transistor of internal IC. However, the leakage current is generated when the L<sub>x</sub> pin voltage is equal or more than V<sub>IN</sub> pin voltage at standby mode.
- R1200xxxxA (with auto discharge function): In the term of standby mode, the switch is turned ON between V<sub>OUT</sub> to GND and the V<sub>OUT</sub> capacitor is discharged.
- R1200xxxxB (without auto discharge function): The built-in switch for discharge does not turn on, but the OVP sense resistors between V<sub>OUT</sub> and GND exists as same as A version.
- However, the both version (A/B) has the OVP sense resistance (4 to 5MΩ) between V<sub>OUT</sub> and GND (refer to OVP sense current (I<sub>VOUT</sub>) on ELECTRICAL CHARACTERISTICS table) and the current flows through from V<sub>OUT</sub> to GND.

## APPLICATION INFORMATION

### ● Typical Applications

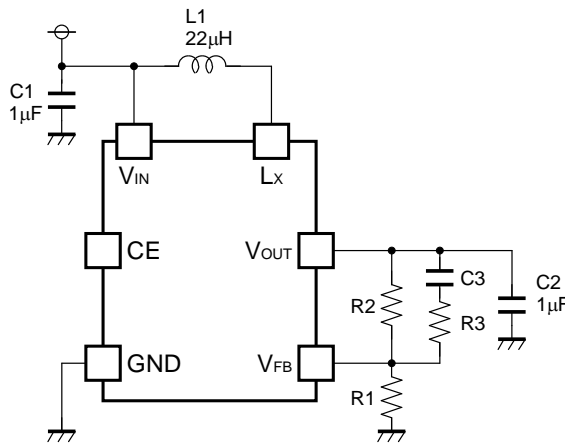

### ● Selection of Inductors

The peak current of the inductor at normal mode can be estimated as the next formula when the efficiency is 80%.

$$I_{Lmax} = 1.25 \times I_{OUT} \times V_{OUT} / V_{IN} + 0.5 \times V_{IN} \times (V_{OUT} - V_{IN}) / (L \times V_{OUT} \times f_{osc})$$

In the case of start-up or dimming control by CE pin, inductor transient current flows, and the peak current of it must be equal or less than the current limit of the IC. The peak current should not beyond the rated current of the inductor.

The recommended inductance value is 4.7 µH – 22 µH.

Table 1 Peak current value in each condition

Condition				
V <sub>IN</sub> (V)	V <sub>OUT</sub> (V)	I <sub>OUT</sub> (mA)	L (µH)	I <sub>Lmax</sub> (mA)
3	14	20	10	215
3	14	20	22	160
3	21	20	10	280
3	21	20	22	225

**Table 2 Recommended inductors**

L (μH)	Part No.	Rated Current (mA)	Size (mm)
10	LQH32CN100K53	450	3.2 x 2.5 x 1.55
10	LQH2MC100K02	225	2.0 x 1.6 x 0.9
10	VLF3010A-100	490	2.8 x 2.6 x 0.9
10	VLS252010-100	520	2.5 x 2.0 x 1.0
22	LQH32CN220K53	250	3.2 x 2.5 x 1.55
22	LQH2MC220K02	185	2.0 x 1.6 x 0.9
22	VLF3010A-220	330	2.8 x 2.6 x 0.9
4.7	LQH32CN4R7M53	650	3.2 x 2.5 x 1.55

● **Selection of Capacitors**

Set 1μF or more value bypass capacitor C1 between V<sub>IN</sub> pin and GND pin as close as possible.  
Set 1μF – 4.7μF or more capacitor C2 between V<sub>OUT</sub> and GND pin.

**Table 3 Recommended components**

	Rated voltage(V)	Part No.
C1	6.3	CM105B105K06
C2	25	GRM21BR11E105K
C3	25	22pF
R1		For V <sub>OUT</sub> Setting
R2		For V <sub>OUT</sub> Setting
R3		2kΩ

● **External Components Setting**

- If the spike noise of V<sub>OUT</sub> may be large, the spike noise may be picked into V<sub>FB</sub> pin and make the operation unstable. In this case, use a R3 of the resistance value in the range from 1kΩ to 5kΩ to reduce a noise level of V<sub>FB</sub>.

● **The Method of Output Voltage Setting**

- The output voltage can be calculated with divider resistors (R1 and R2) values as the following formula:

$$\text{Output Voltage} = V_{FB} \times (R1 + R2) / R1$$

- The total value of R1 and R2 should be equal or less than 300kΩ. Make the V<sub>IN</sub> and GND line sufficient. The large current flows through the V<sub>IN</sub> and GND line due to the switching. If this impedance (V<sub>IN</sub> and GND line) is high, the internal voltage of the IC may shift by the switching current, and the operating may become unstable. Moreover, when the built-in L<sub>x</sub> switch is turn OFF, the spike noise caused by the inductor may be generated. As a result of this, recommendation voltage rating of capacitor (C2) value is equal 1.5 times larger or more than the setting output voltage.

## R1200x

NO.EA-192-170925

## TECHNICAL NOTES

### ● Current Path on PCB

The current paths in an application circuit are shown in Fig. 1 and 2.

A current flows through the paths shown in Fig. 1 at the time of MOSFET-ON, and shown in Fig. 2 at the time of MOSFET-OFF. In the paths pointed with red arrows in Fig. 2, current flows just in MOSFET-ON period or just in MOSFET-OFF period. Parasitic impedance/inductance and the capacitance of these paths influence stability of the system and cause noise outbreak. So please minimize this side effect. In addition, please shorten the wiring of other current paths shown in Fig. 1 and 2 except for the paths of LED load.

### ● Layout Guide for PCB

- Please shorten the wiring of the input capacitor (C1) between  $V_{IN}$  pin and GND pin of IC. The GND pin should be connected to the strong GND plane.
- The area of  $L_x$  land pattern should be smaller.
- Please put output capacitor (C2) close to the  $V_{OUT}$  pin.
- Please make the GND side of output capacitor (C2) close to the GND pin of IC.

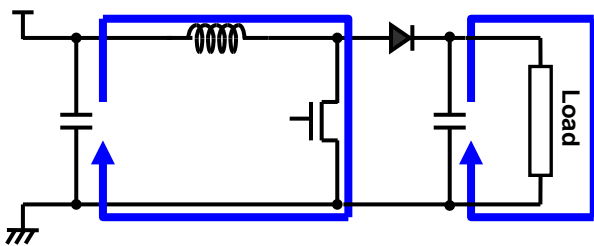

Fig. 1 MOSFET-ON

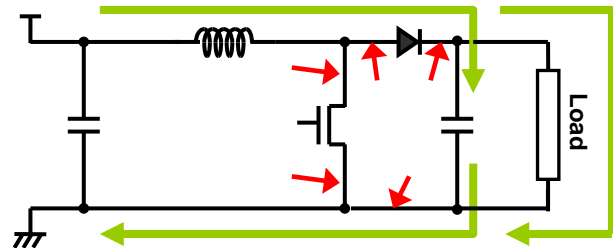
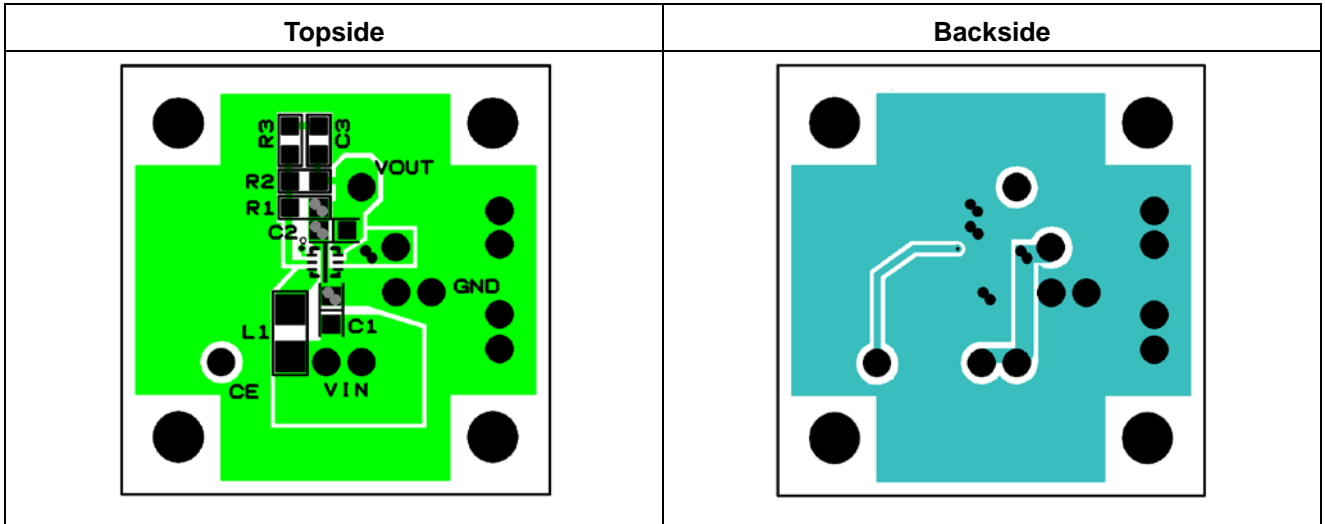

Fig. 2 MOSFET-OFF

● PCB Layout

- PKG: DFN1616-6pin

R1200L Typical Board Layout



- PKG:DFN(PLP)1820-6pin

R1200K Typical Board Layout

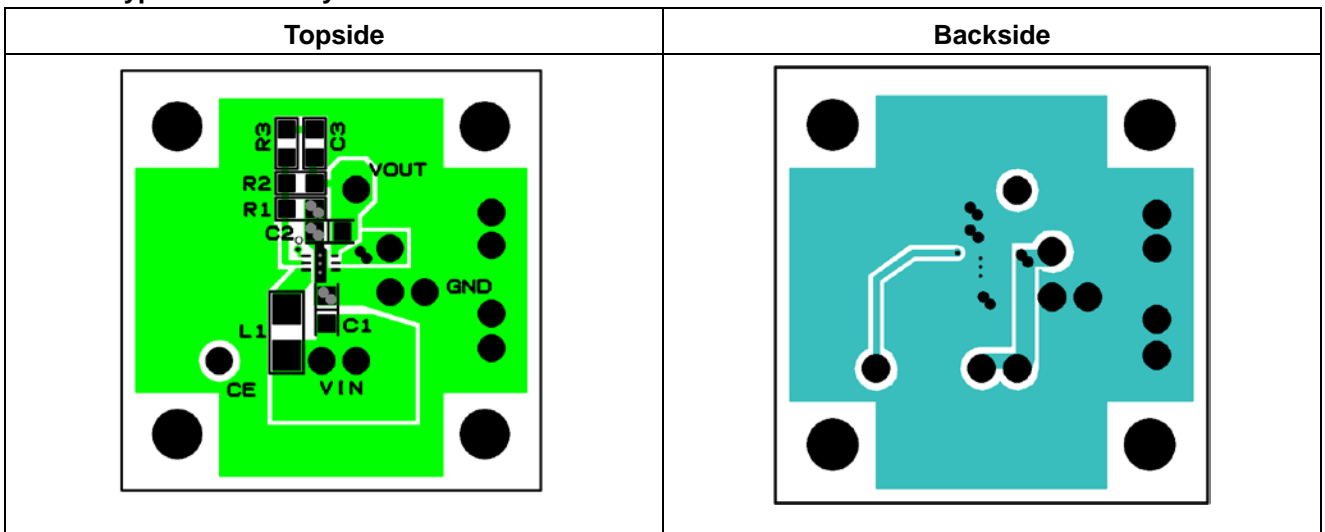

R1200Z (WLCSP-6-P1) is the discontinued product as of September 2017.  
R1200K (DFN(PLP)1820-6) is the non-promotional product as of March 2019.

**R1200x**

NO.EA-192-170925

• PKG:SOT-23-6pin

**R1200N Typical Board Layout**

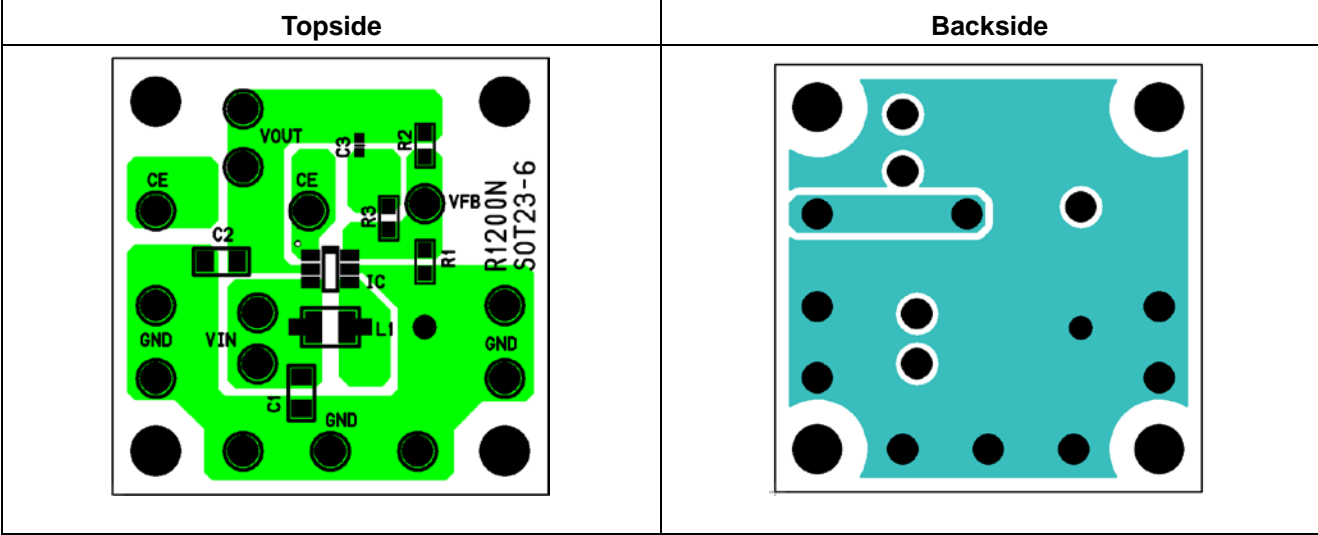

## TYPICAL CHARACTERISTICS

### 1) Output Voltage vs. Output Current ( $L=22\mu\text{H}$ )

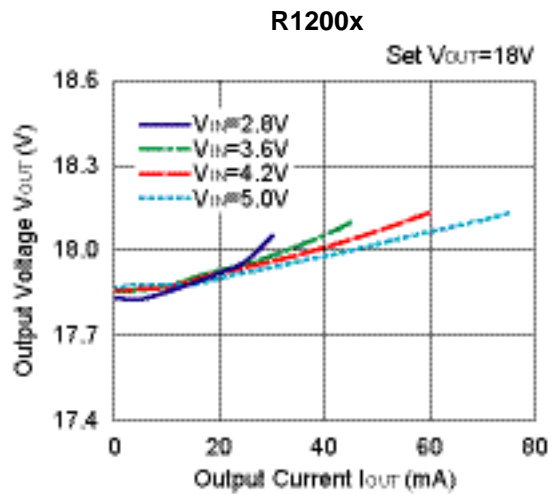
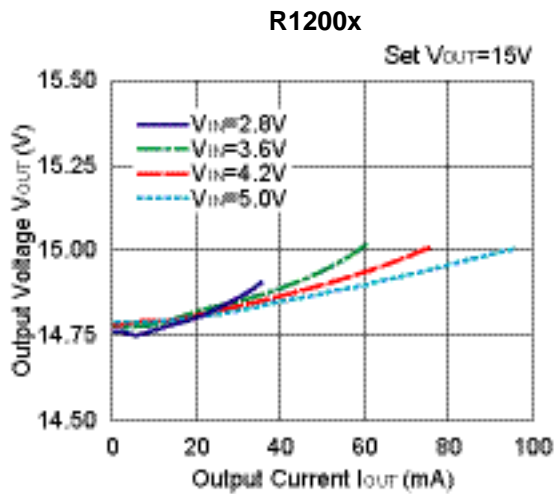
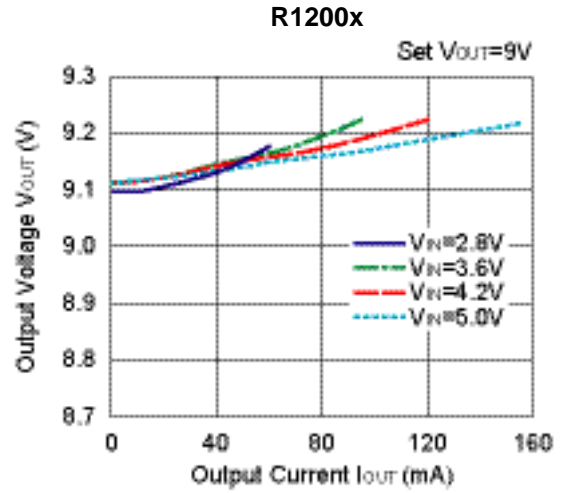
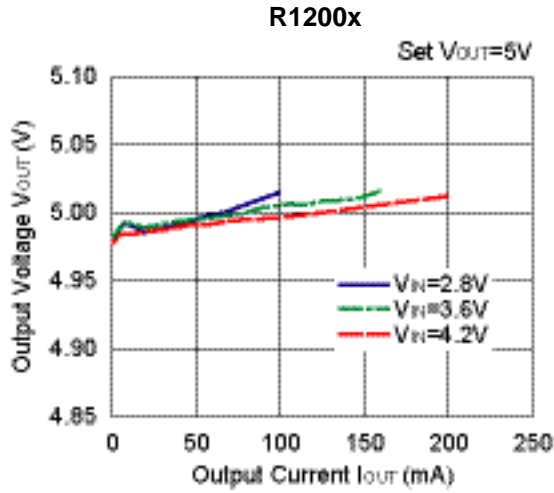

### 2) Efficiency vs. Output Current

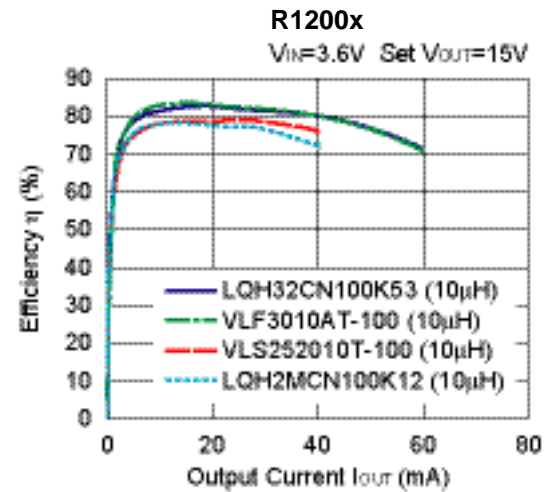
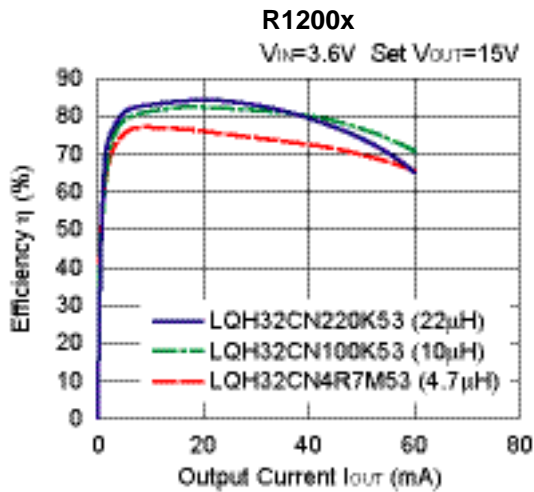

**R1200x**

NO.EA-192-170925

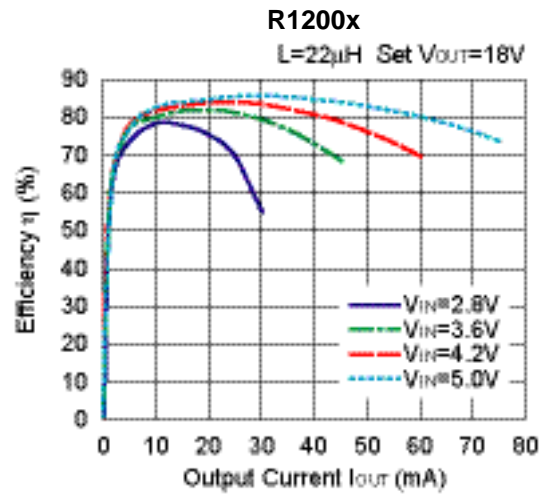
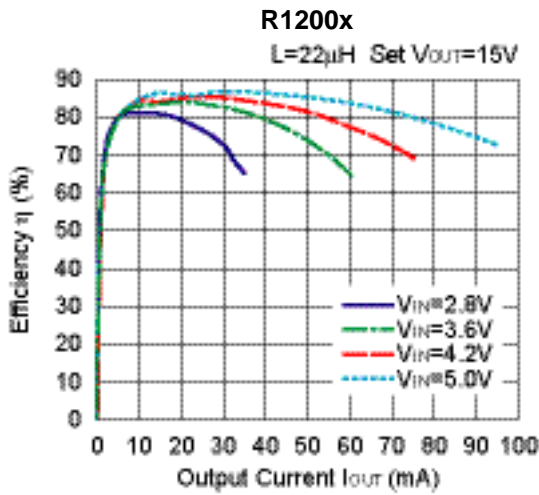
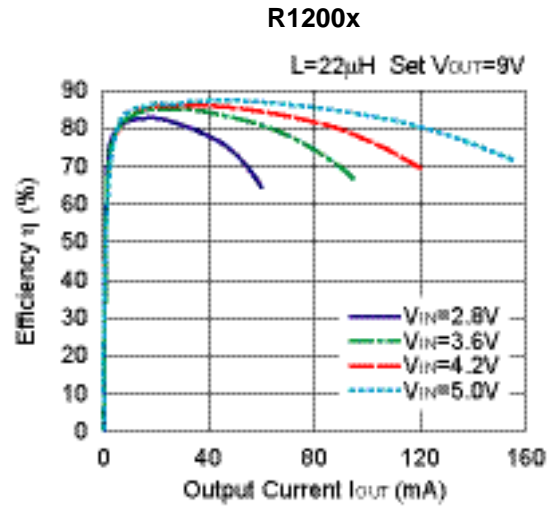
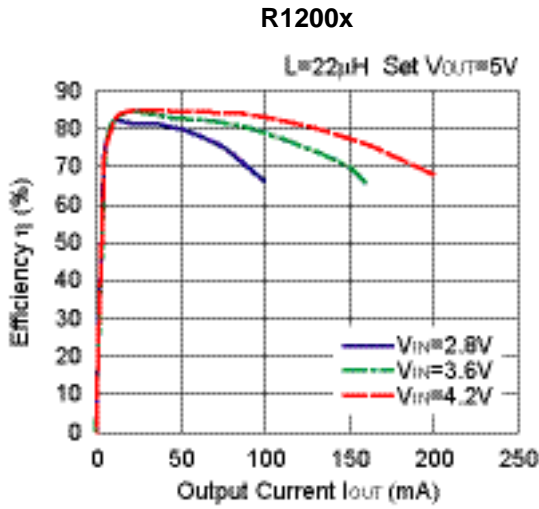

**3) OVP Sense Current vs. Temperature**

**R1200x**

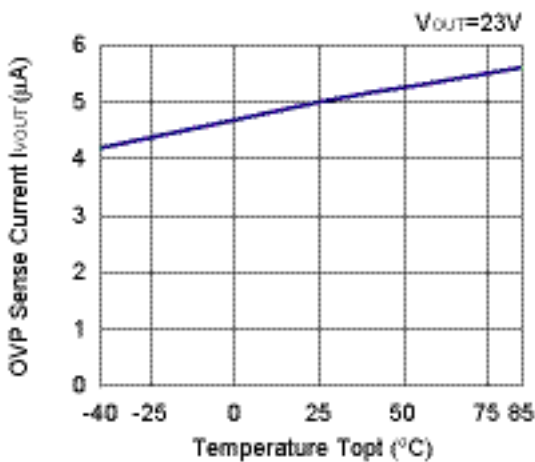

**4) Supply Current vs. Temperature**

**R1200x**

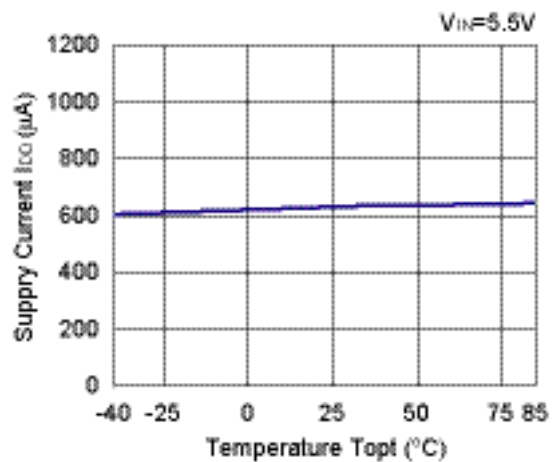



5) CE Pulldown Resistance vs. Temperature  
R1200x

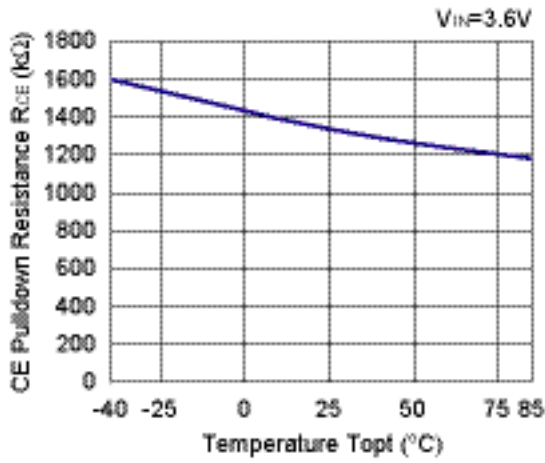

6) CE Input Voltage "L" vs. Temperature  
R1200x

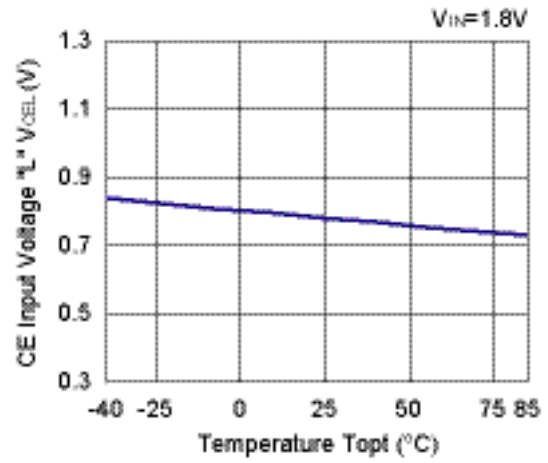

7) CE Input Voltage "H" vs. Temperature  
R1200x

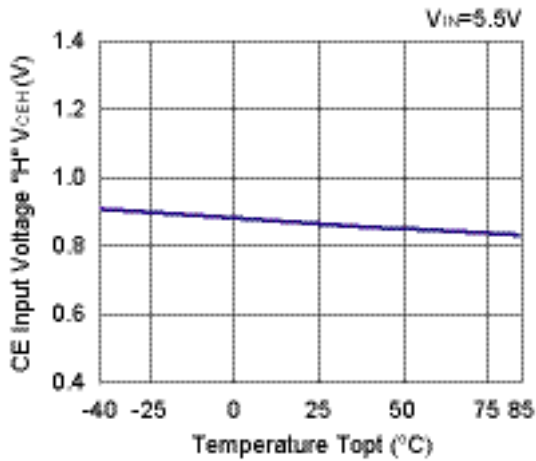

8) NPN V<sub>CE</sub> Voltage vs. Temperature  
R1200x

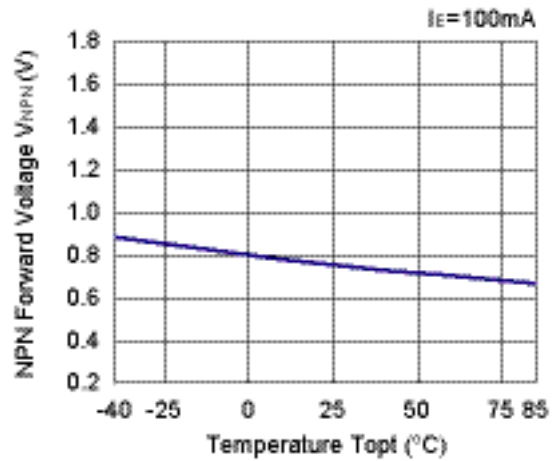

9) V<sub>FB</sub> Voltage vs. Temperature  
R1200x

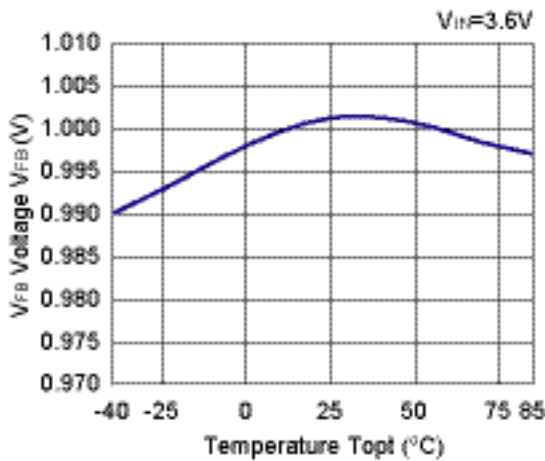

10) UVLO Detect / Released Voltage vs. Temperature  
R1200x

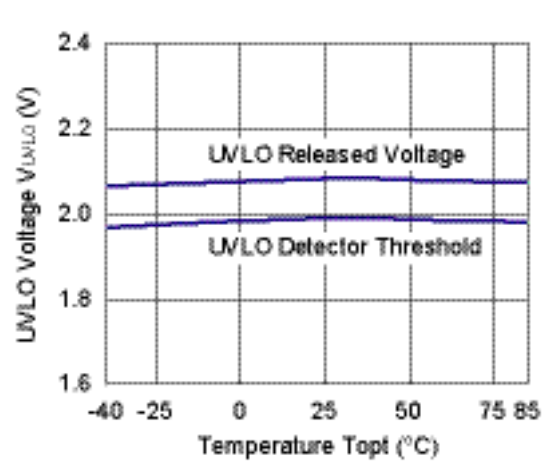

## R1200x

NO.EA-192-170925

11) Oscillator Frequency vs. Temperature  
R1200x

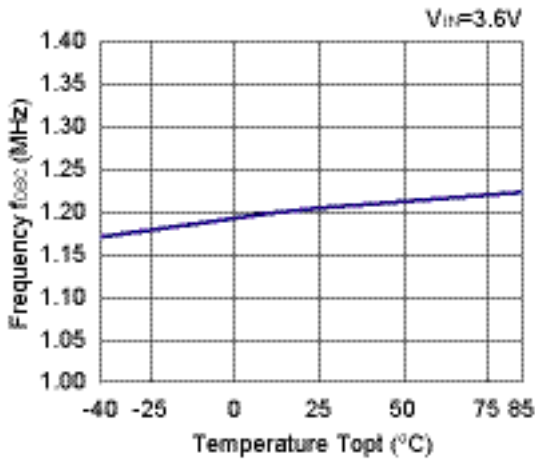

12) Maxduty vs. Temperature  
R1200x

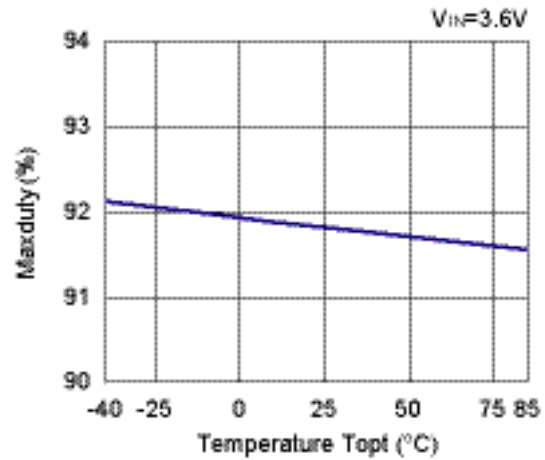

13) OVP Detect / Released Voltage vs. Temperature  
R1200x001x

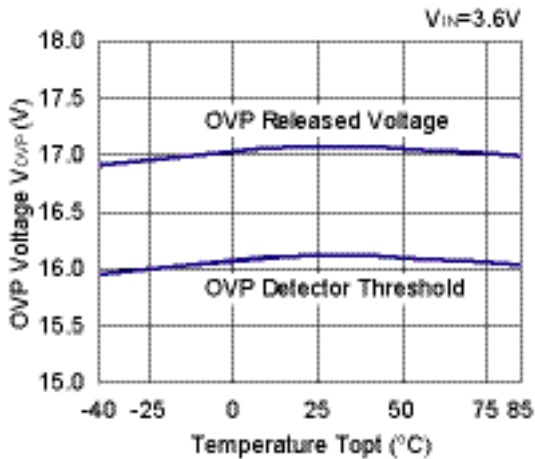

14) Soft-start Time vs. Temperature  
R1200x

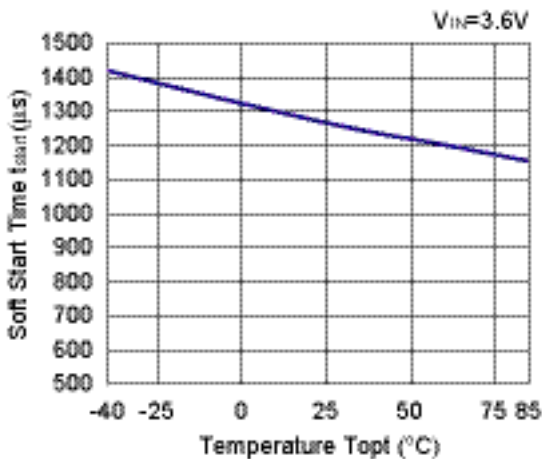

15) V<sub>OUT</sub> Discharge Current vs. Temperature  
R1200x

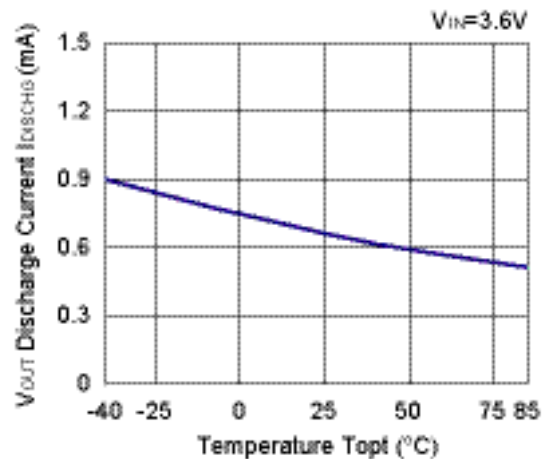

16) Lx Limit Current vs. Temperature  
 R1200x

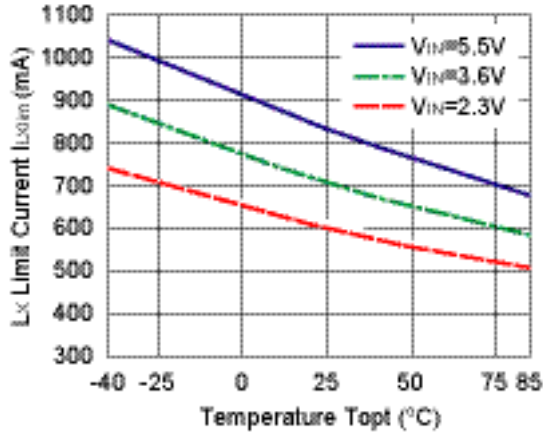

17) Switch ON Resistance vs. Temperature  
 R1200x

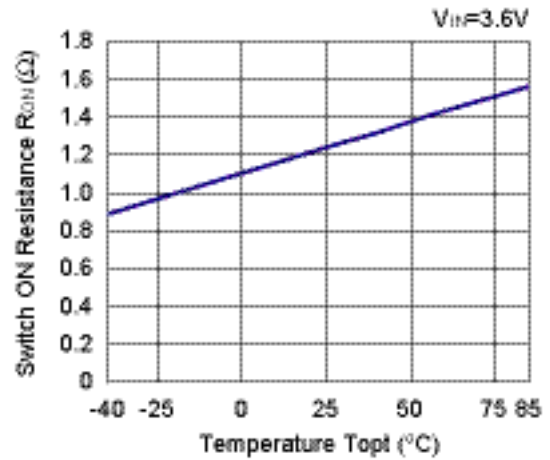

18) Load Transient Response (V<sub>IN</sub>=3.6V, I<sub>OUT</sub>=5mA↔25mA, t<sub>r</sub>=t<sub>f</sub>=0.5μs)

R1200x

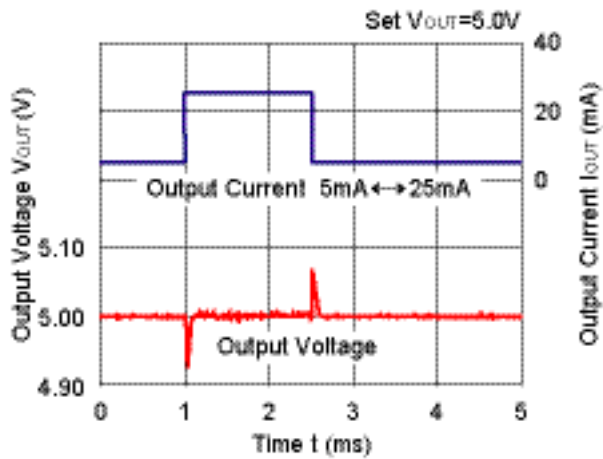

R1200x

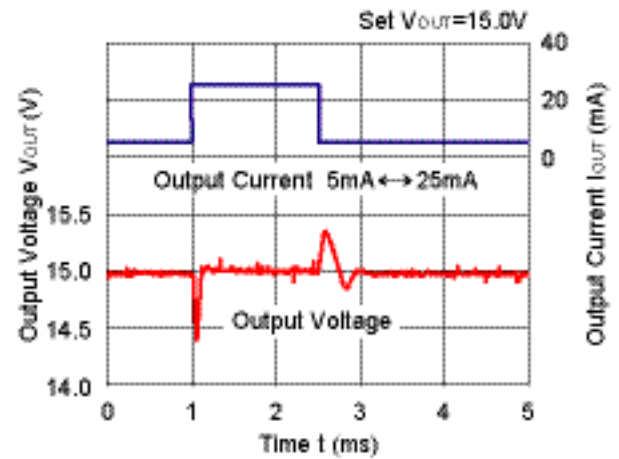

19) Start-up Waveform (V<sub>IN</sub>=3.6V, I<sub>OUT</sub>=20mA)

R1200x001A

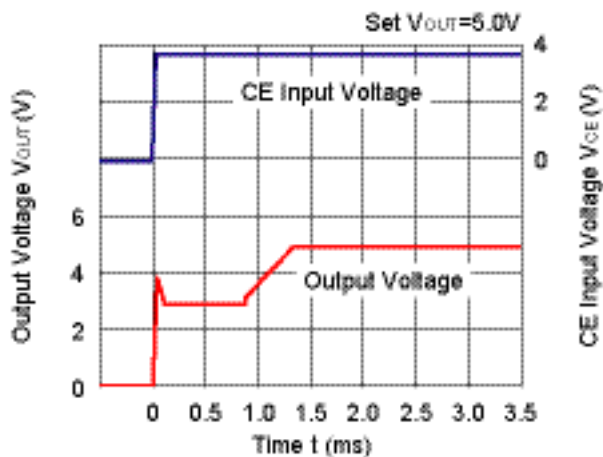

R1200x003A

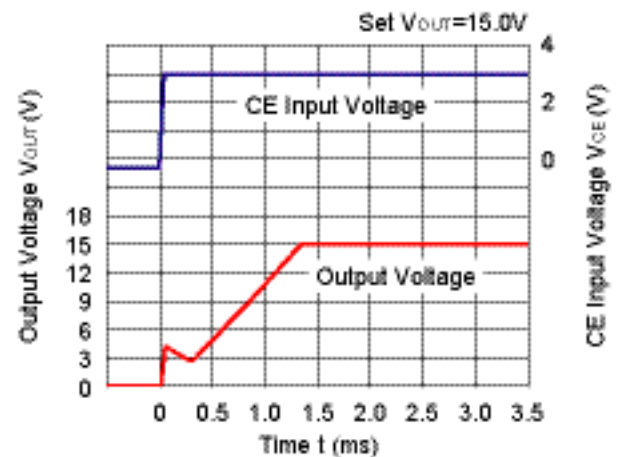

## R1200x

NO.EA-192-170925

### 20) Shut-down Waveform ( $V_{IN}=3.6V$ , $I_{OUT}=20mA$ )

R1200x001A

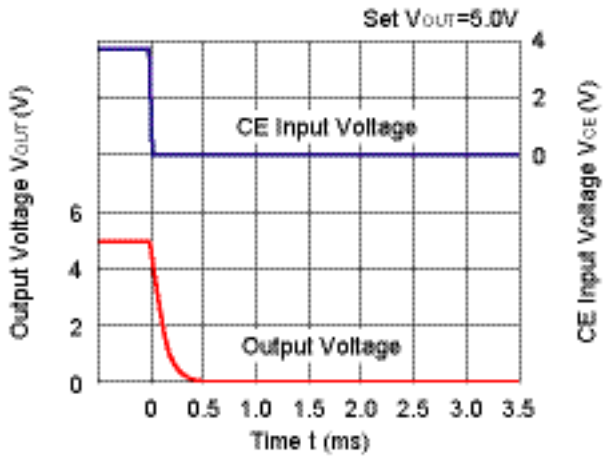

R1200x003A

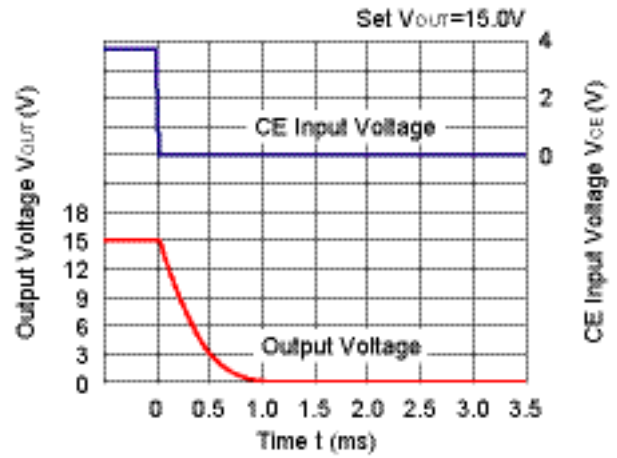

### 21) OVP Waveform ( $V_{FB}=0V$ )

R1200x001A

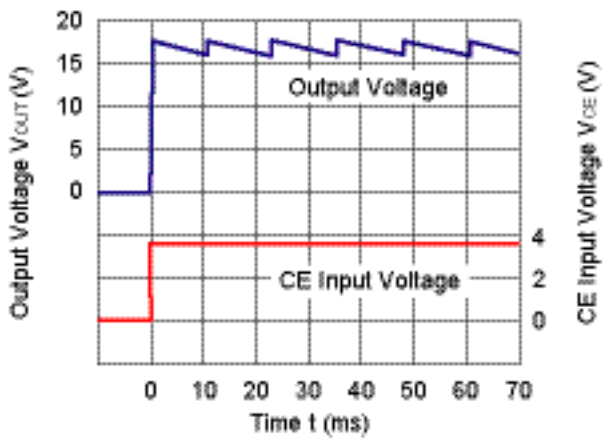

## POWER DISSIPATION

## WLCSP-6-P1

Ver. A

The power dissipation of the package is dependent on PCB material, layout, and environmental conditions. The following conditions are used in this measurement.

### Measurement Conditions

	Standard Test Land Pattern
Environment	Mounting on Board (Wind Velocity = 0 m/s)
Board Material	Glass Cloth Epoxy Plastic (Double-Sided Board)
Board Dimensions	40 mm × 40 mm × 1.6 mm
Copper Ratio	Top Side: Approx. 50% Bottom Side: Approx. 50%
Through-holes	-

### Measurement Result

(Ta = 25°C, Tjmax = 125°C)

	Standard Test Land Pattern
Power Dissipation	633 mW
Thermal Resistance	$\theta_{ja} = (125 - 25^\circ\text{C}) / 0.633 \text{ W} = 158^\circ\text{C/W}$

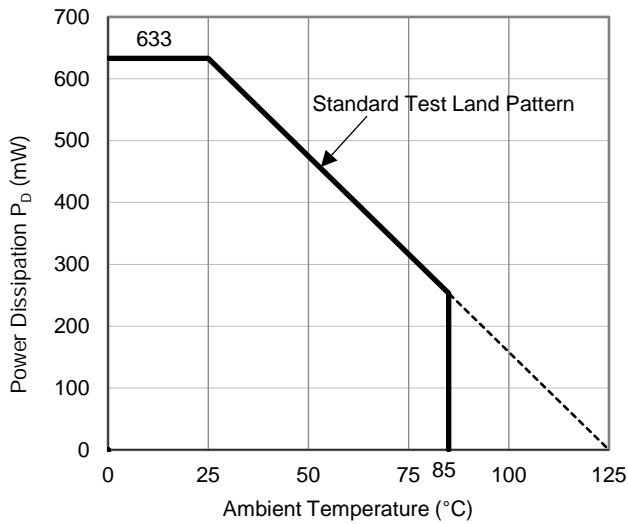

Power Dissipation vs. Ambient Temperature

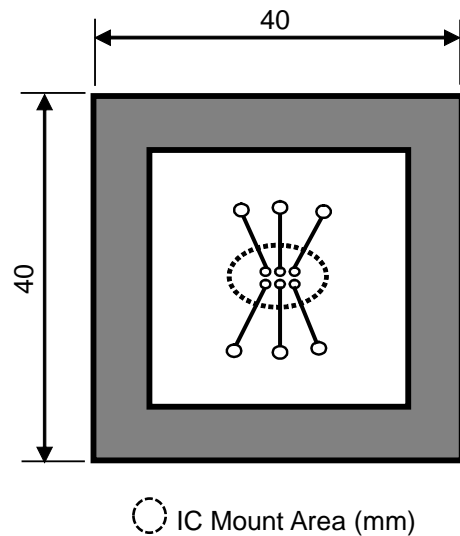

Measurement Board Pattern

R1200Z (WLCSP-6-P1) is the discontinued product as of September 2017.  
 R1200K (DFN(PLP)1820-6) is the non-promotional product as of March 2019.

**PACKAGE DIMENSIONS**

**WLCSP-6-P1**

Ver. A

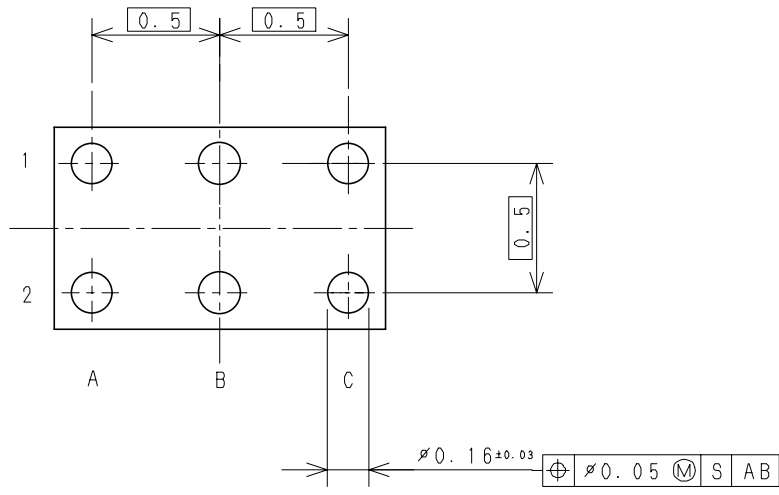
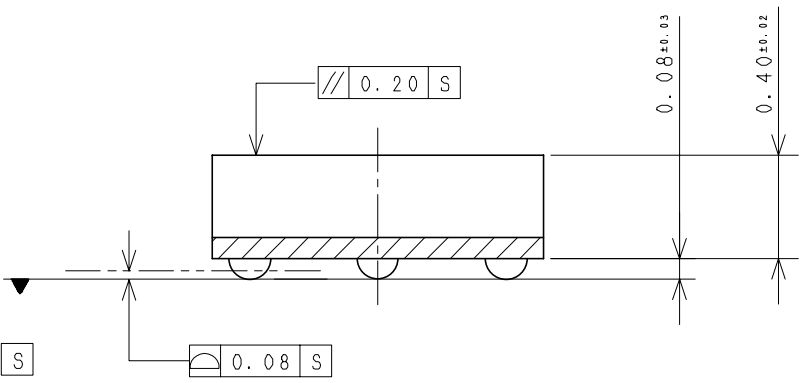
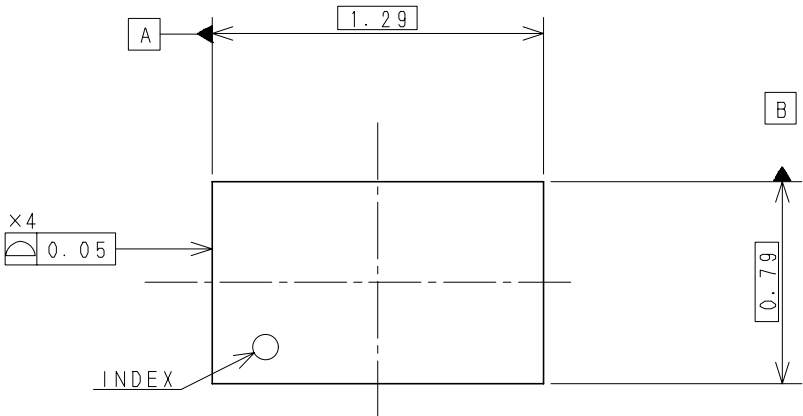

**WLCSP-6-P1 Package Dimensions (Unit: mm)**

## POWER DISSIPATION

## DFN1616-6

Ver. A

The power dissipation of the package is dependent on PCB material, layout, and environmental conditions. The following conditions are used in this measurement.

### Measurement Conditions

Item	Measurement Conditions (JEDEC STD. 51-7)
Environment	Mounting on Board (Wind Velocity = 0 m/s)
Board Material	Glass Cloth Epoxy Plastic (Four-Layer Board)
Board Dimensions	76.2 mm × 114.3 mm × 0.8 mm
Copper Ratio	1st Layer: Less than 95% of 50 mm Square 2nd, 3rd, 4th Layers: Approx. 100% of 50 mm Square
Through-holes	φ 0.2 mm × 15 pcs

### Measurement Result

(Ta = 25°C, Tjmax = 125°C)

Item	Measurement Result
Power Dissipation	2400 mW
Thermal Resistance ( $\theta_{ja}$ )	$\theta_{ja} = 41^{\circ}\text{C}/\text{W}$
Thermal Characterization Parameter ( $\psi_{jt}$ )	$\psi_{jt} = 11^{\circ}\text{C}/\text{W}$

$\theta_{ja}$ : Junction-to-ambient thermal resistance.

$\psi_{jt}$ : Junction-to-top of package thermal characterization parameter.

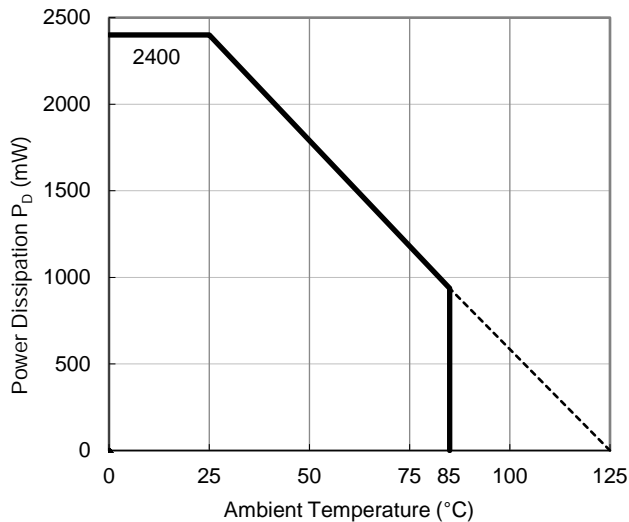

Power Dissipation vs. Ambient Temperature

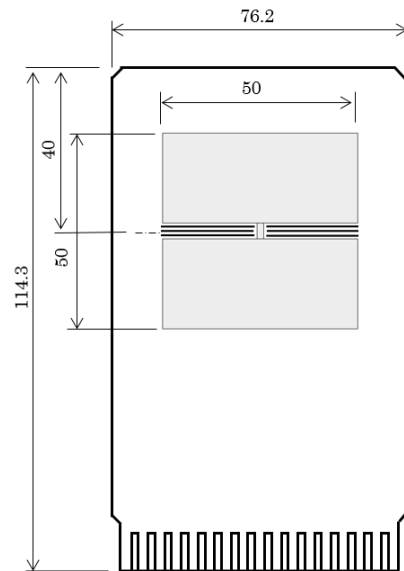

Measurement Board Pattern

R1200Z (WLCSP-6-P1) is the discontinued product as of September 2017.  
 R1200K (DFN(PLP)1820-6) is the non-promotional product as of March 2019.

**PACKAGE DIMENSIONS**

**DFN1616-6**

Ver. A

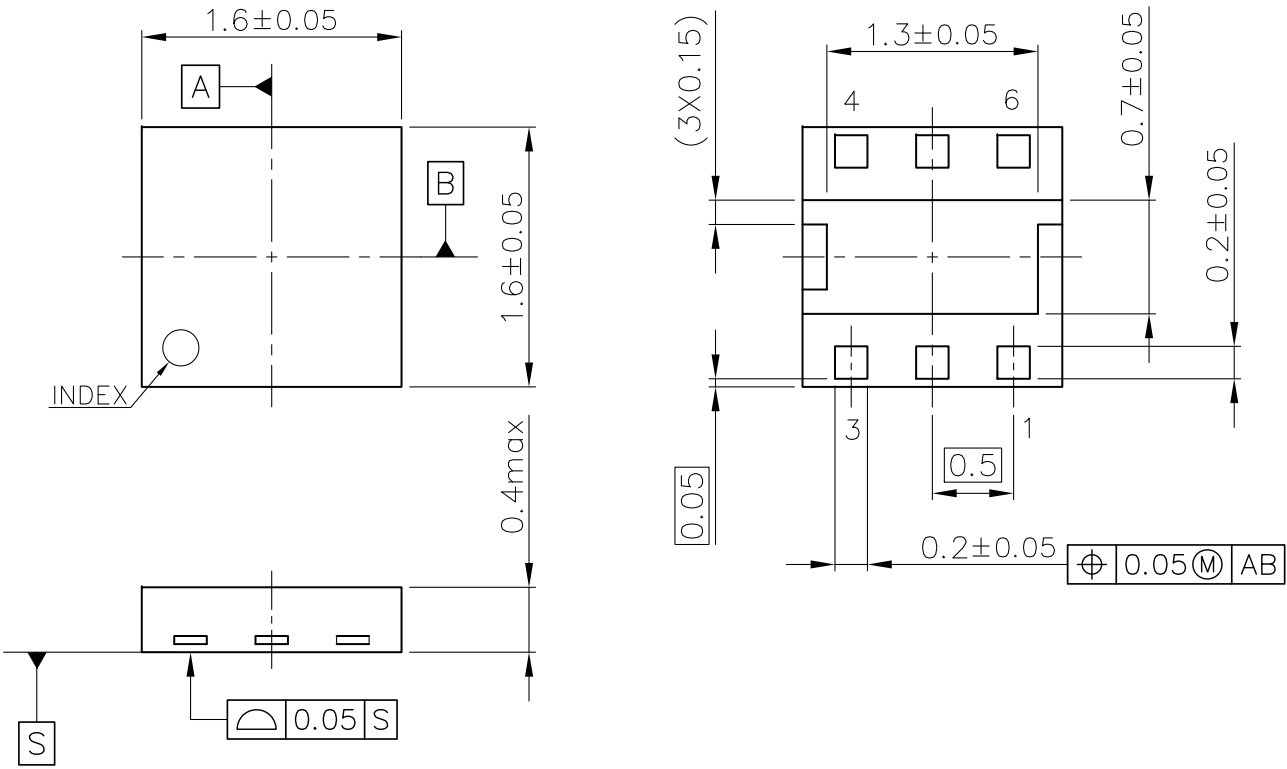

**DFN1616-6 Package Dimensions (Unit: mm)**

\* The tab on the bottom of the package shown by blue circle is a substrate potential (GND). It is recommended that this tab be connected to the ground plane on the board but it is possible to leave the tab floating.



R1200Z (WLCSP-6-P1) is the discontinued product as of September 2017.  
R1200K (DFN(PLP)1820-6) is the non-promotional product as of March 2019.

## POWER DISSIPATION

## DFN(PLP)1820-6

Ver. A

The power dissipation of the package is dependent on PCB material, layout, and environmental conditions. The following conditions are used in this measurement.

### Measurement Conditions

Item	Measurement Conditions (JEDEC STD. 51-7)
Environment	Mounting on Board (Wind Velocity = 0 m/s)
Board Material	Glass Cloth Epoxy Plastic (Four-Layer Board)
Board Dimensions	76.2 mm × 114.3 mm × 0.8 mm
Copper Ratio	1st Layer: Less than 95% of 50 mm Square 2nd, 3rd, 4th Layers: Approx. 100% of 50 mm Square
Through-holes	φ 0.2 mm × 34 pcs

### Measurement Result

(Ta = 25°C, Tjmax = 125°C)

Item	Measurement Result
Power Dissipation	2200 mW
Thermal Resistance ( $\theta_{ja}$ )	$\theta_{ja} = 45^{\circ}\text{C}/\text{W}$
Thermal Characterization Parameter ( $\psi_{jt}$ )	$\psi_{jt} = 18^{\circ}\text{C}/\text{W}$

$\theta_{ja}$ : Junction-to-ambient thermal resistance.

$\psi_{jt}$ : Junction-to-top of package thermal characterization parameter.

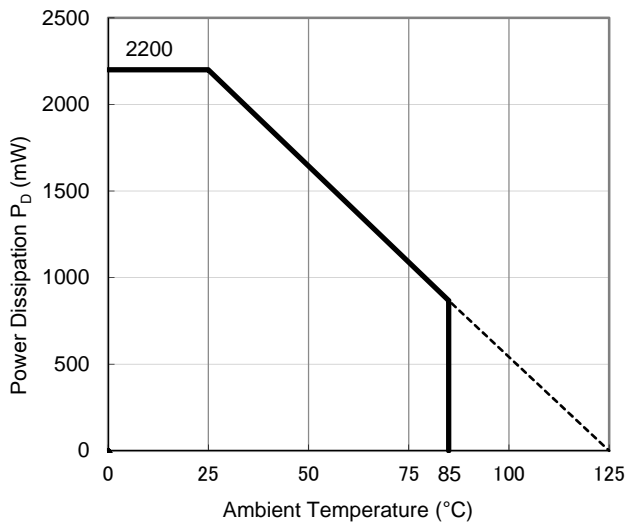

Power Dissipation vs. Ambient Temperature

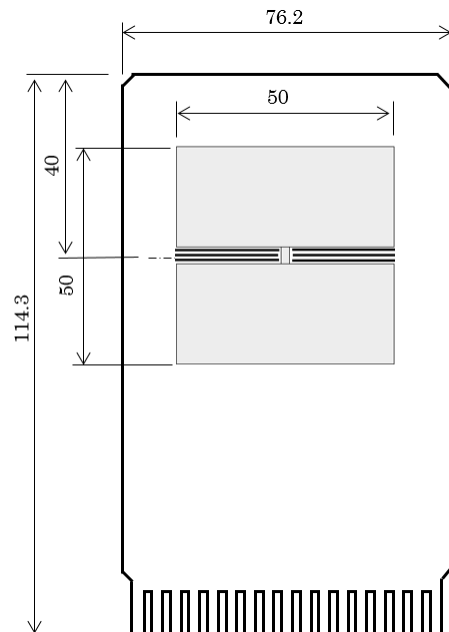

Measurement Board Pattern

R1200Z (WLCSP-6-P1) is the discontinued product as of September 2017.  
 R1200K (DFN(PLP)1820-6) is the non-promotional product as of March 2019.

**PACKAGE DIMENSIONS**

**DFN(PLP)1820-6**

Ver. A

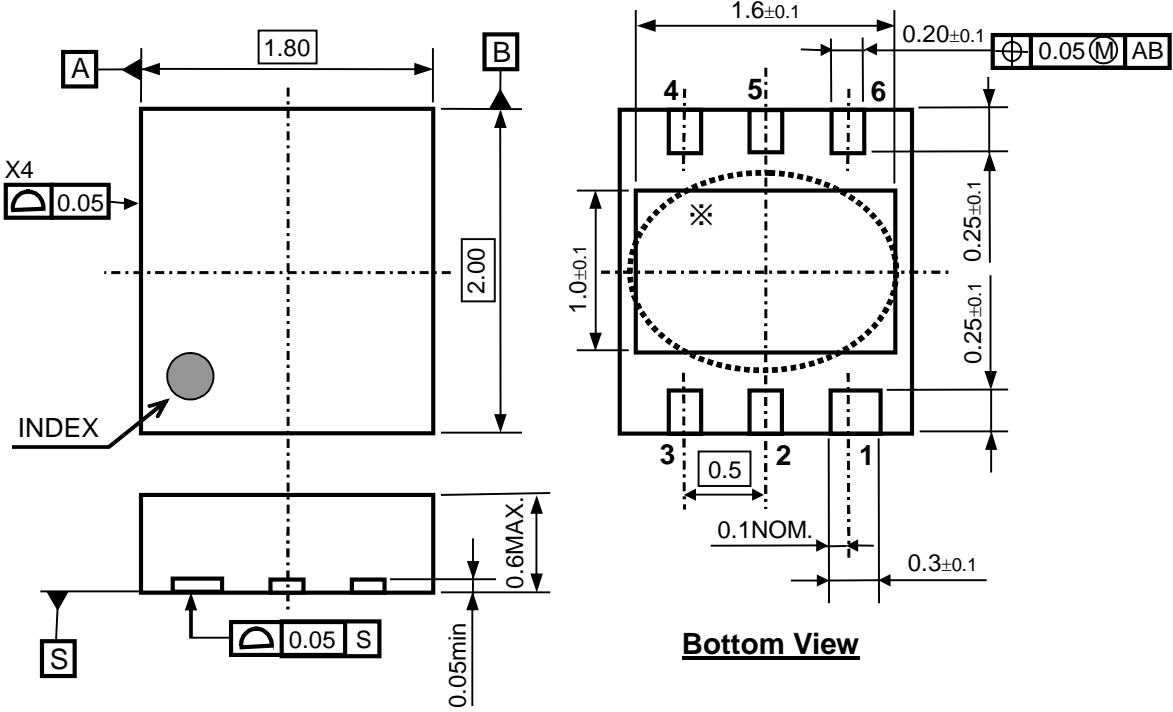

DFN(PLP)1820-6 Package Dimensions (Unit: mm)

\* The tab on the bottom of the package is substrate level (GND). It is recommended that the tab be connected to the ground plane on the board, or otherwise be left floating.

## POWER DISSIPATION

## SOT-23-6

Ver. A

The power dissipation of the package is dependent on PCB material, layout, and environmental conditions. The following conditions are used in this measurement.

### Measurement Conditions

Item	Measurement Conditions (JEDEC STD. 51-7)
Environment	Mounting on Board (Wind Velocity = 0 m/s)
Board Material	Glass Cloth Epoxy Plastic (Four-Layer Board)
Board Dimensions	76.2 mm × 114.3 mm × 0.8 mm
Copper Ratio	1st Layer : Less than 95% of 50 mm Square 2nd, 3rd, 4th Layers: Approx. 100% of 50 mm Square
Through-holes	φ 0.3 mm × 7 pcs

### Measurement Result

(Ta = 25°C, Tjmax = 125°C)

Item	Measurement Result
Power Dissipation	660 mW
Thermal Resistance ( $\theta_{ja}$ )	$\theta_{ja} = 150^{\circ}\text{C}/\text{W}$
Thermal Characterization Parameter ( $\psi_{jt}$ )	$\psi_{jt} = 51^{\circ}\text{C}/\text{W}$

$\theta_{ja}$ : Junction-to-ambient thermal resistance.

$\psi_{jt}$ : Junction-to-top of package thermal characterization parameter

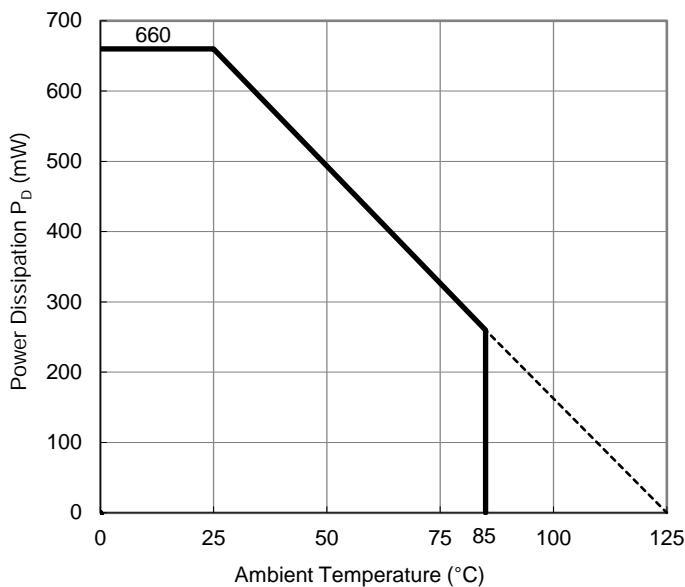

Power Dissipation vs. Ambient Temperature

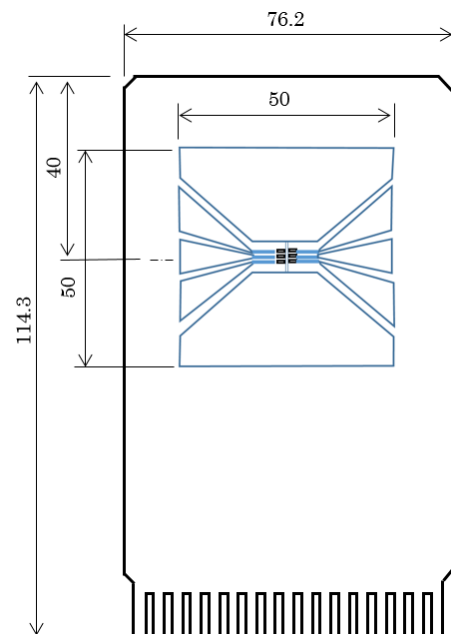

Measurement Board Pattern

R1200Z (WLCSP-6-P1) is the discontinued product as of September 2017.  
R1200K (DFN(PLP)1820-6) is the non-promotional product as of March 2019.

## PACKAGE DIMENSIONS

## SOT-23-6

Ver. A

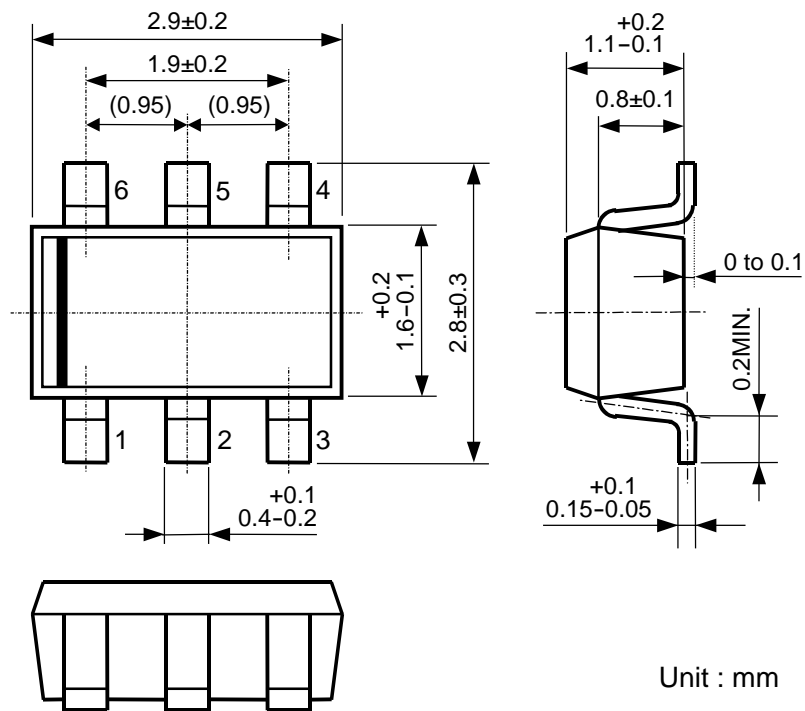

SOT-23-6 Package Dimensions



1. The products and the product specifications described in this document are subject to change or discontinuation of production without notice for reasons such as improvement. Therefore, before deciding to use the products, please refer to Ricoh sales representatives for the latest information thereon.
2. The materials in this document may not be copied or otherwise reproduced in whole or in part without prior written consent of Ricoh.
3. Please be sure to take any necessary formalities under relevant laws or regulations before exporting or otherwise taking out of your country the products or the technical information described herein.
4. The technical information described in this document shows typical characteristics of and example application circuits for the products. The release of such information is not to be construed as a warranty of or a grant of license under Ricoh's or any third party's intellectual property rights or any other rights.
5. The products listed in this document are intended and designed for use as general electronic components in standard applications (office equipment, telecommunication equipment, measuring instruments, consumer electronic products, amusement equipment etc.). Those customers intending to use a product in an application requiring extreme quality and reliability, for example, in a highly specific application where the failure or misoperation of the product could result in human injury or death (aircraft, spacevehicle, nuclear reactor control system, traffic control system, automotive and transportation equipment, combustion equipment, safety devices, life support system etc.) should first contact us.
6. We are making our continuous effort to improve the quality and reliability of our products, but semiconductor products are likely to fail with certain probability. In order to prevent any injury to persons or damages to property resulting from such failure, customers should be careful enough to incorporate safety measures in their design, such as redundancy feature, fire containment feature and fail-safe feature. We do not assume any liability or responsibility for any loss or damage arising from misuse or inappropriate use of the products.
7. Anti-radiation design is not implemented in the products described in this document.
8. The X-ray exposure can influence functions and characteristics of the products. Confirm the product functions and characteristics in the evaluation stage.
9. WLCSP products should be used in light shielded environments. The light exposure can influence functions and characteristics of the products under operation or storage.
10. There can be variation in the marking when different AOI (Automated Optical Inspection) equipment is used. In the case of recognizing the marking characteristic with AOI, please contact Ricoh sales or our distributor before attempting to use AOI.
11. Please contact Ricoh sales representatives should you have any questions or comments concerning the products or the technical information.



**Ricoh is committed to reducing the environmental loading materials in electrical devices with a view to contributing to the protection of human health and the environment.**

Ricoh has been providing RoHS compliant products since April 1, 2006 and Halogen-free products since April 1, 2012.

**RICOH** RICOH ELECTRONIC DEVICES CO., LTD.

<https://www.e-devices.ricoh.co.jp/en/>

#### Sales & Support Offices

##### **Ricoh Electronic Devices Co., Ltd.**

##### **Shin-Yokohama Office (International Sales)**

2-3, Shin-Yokohama 3-chome, Kohoku-ku, Yokohama-shi, Kanagawa, 222-8530, Japan  
Phone: +81-50-3814-7687 Fax: +81-45-474-0074

##### **Ricoh Americas Holdings, Inc.**

675 Campbell Technology Parkway, Suite 200 Campbell, CA 95008, U.S.A.  
Phone: +1-408-610-3105

##### **Ricoh Europe (Netherlands) B.V.**

##### **Semiconductor Support Centre**

Prof. W.H. Keesomlaan 1, 1183 DJ Amstelveen, The Netherlands  
Phone: +31-20-5474-309

##### **Ricoh International B.V. - German Branch**

##### **Semiconductor Sales and Support Centre**

Oberrather Strasse 6, 40472 Düsseldorf, Germany  
Phone: +49-211-6546-0

##### **Ricoh Electronic Devices Korea Co., Ltd.**

3F, Haesung Bldg, 504, Teheran-ro, Gangnam-gu, Seoul, 135-725, Korea  
Phone: +82-2-2135-5700 Fax: +82-2-2051-5713

##### **Ricoh Electronic Devices Shanghai Co., Ltd.**

Room 403, No.2 Building, No.690 Bibo Road, Pu Dong New District, Shanghai 201203,  
People's Republic of China  
Phone: +86-21-5027-3200 Fax: +86-21-5027-3299

##### **Ricoh Electronic Devices Shanghai Co., Ltd.**

##### **Shenzhen Branch**

1205, Block D (Jinlong Building), Kingkey 100, Hongbao Road, Luohu District,  
Shenzhen, China  
Phone: +86-755-8348-7600 Ext 225

##### **Ricoh Electronic Devices Co., Ltd.**

##### **Taipei office**

Room 109, 10F-1, No.51, Hengyang Rd., Taipei City, Taiwan  
Phone: +886-2-2313-1621/1622 Fax: +886-2-2313-1623