

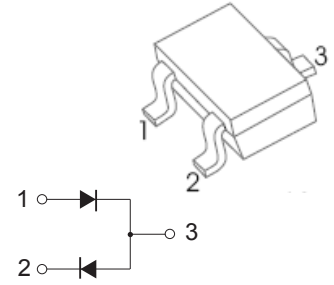

## SOT-323 Plastic-Encapsulate Diodes

**RB706F-40** Schottky Barrier Diode

SOT-323



### FEATURES

- Small package
- Low  $V_F$  and low  $I_R$
- High reliability

**MARKING: 3J •**

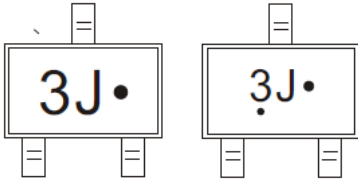

Solid dot = Green molding compound device, if none, the normal device.

**Maximum Ratings @Ta=25°C**

Parameter	Symbol	Limit	Unit
Peak reverse voltage	$V_{RM}$	45	V
DC reverse voltage	$V_R$	40	V
Mean rectifying current	$I_O$	30	mA
Non-repetitive Peak Forward Surge Current@t=8.3ms	$I_{FSM}$	200	mA
Power dissipation	$P_D$	200	mW
Thermal Resistance from Junction to Ambient	$R_{\theta JA}$	500	°C/W
Junction temperature	$T_j$	125	°C
Storage temperature	$T_{stg}$	-55+150	°C

**Electrical Ratings @Ta=25°C**

Parameter	Symbol	Min	Typ	Max	Unit	Conditions
Forward voltage	$V_F$			0.37	V	$I_F=1mA$
Reverse current	$I_R$			1	μA	$V_R=10V$
Capacitance between terminals	$C_T$		2		pF	$V_R=1V, f=1MHz$

# Typical Characteristics

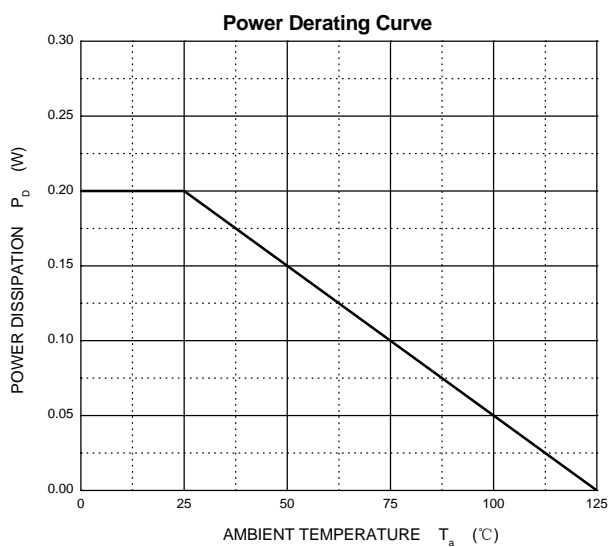
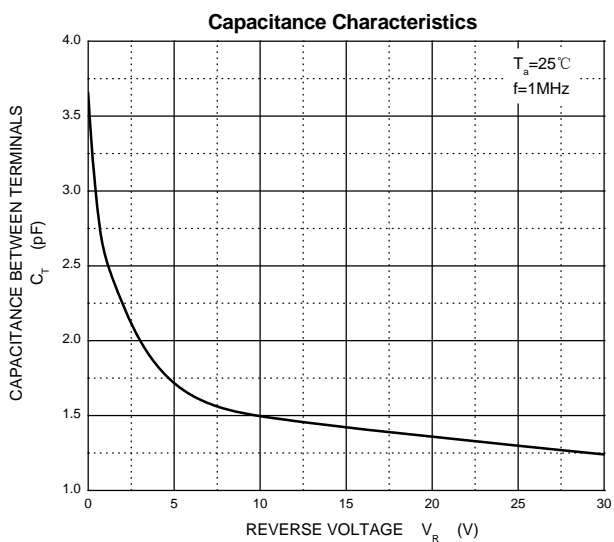
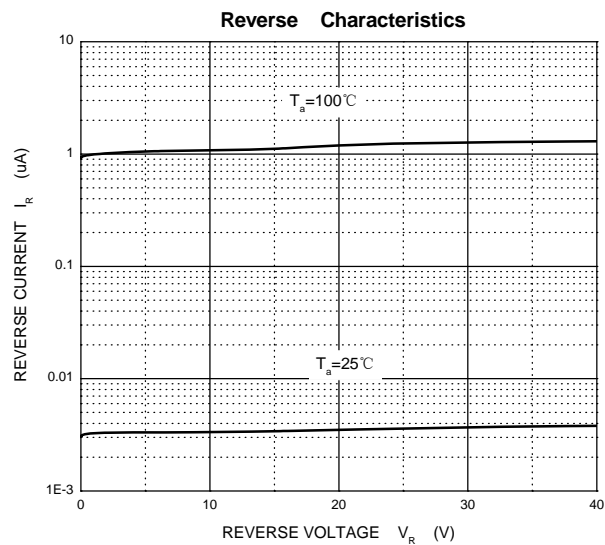
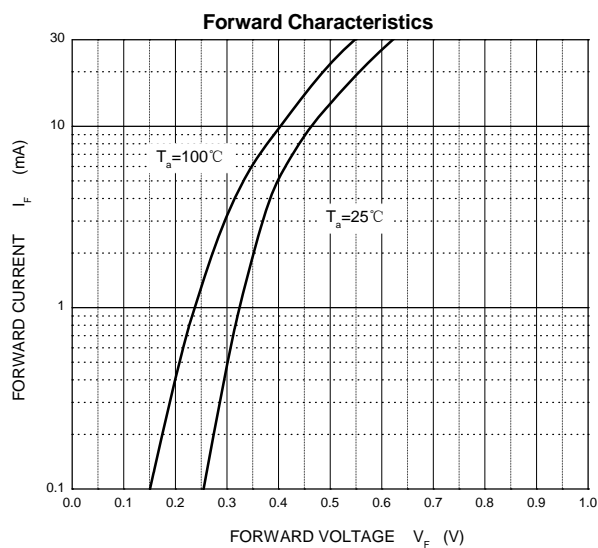

## SOT-323 Package Outline Dimensions

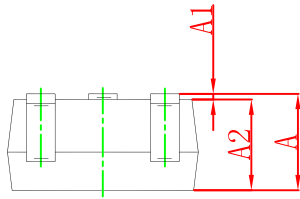
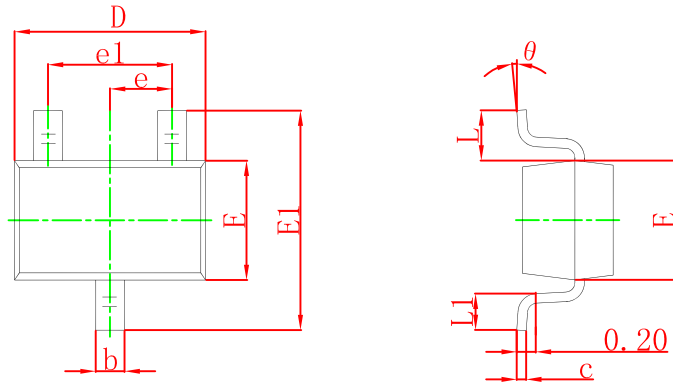

Symbol	Dimensions In Millimeters		Dimensions In Inches	
	Min	Max	Min	Max
A	0.900	1.100	0.035	0.043
A1	0.000	0.100	0.000	0.004
A2	0.900	1.000	0.035	0.039
b	0.200	0.400	0.008	0.016
c	0.080	0.150	0.003	0.006
D	2.000	2.200	0.079	0.087
E	1.150	1.350	0.045	0.053
E1	2.150	2.450	0.085	0.096
e	0.650 TYP		0.026 TYP	
e1	1.200	1.400	0.047	0.055
L	0.525 REF		0.021 REF	
L1	0.260	0.460	0.010	0.018
$\theta$	0°	8°	0°	8°

## SOT-323 Suggested Pad Layout

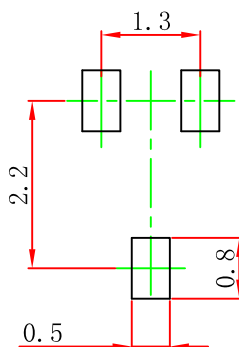

Note:

1. Controlling dimension: in millimeters.
2. General tolerance:  $\pm 0.05$  mm.
3. The pad layout is for reference purposes only.

### NOTICE

JCET reserve the right to make modifications, enhancements, improvements, corrections or other changes without further notice to any product herein. JCET does not assume any liability arising out of the application or use of any product described herein.

# SOT-323 Tape and Reel

## SOT-323 Embossed Carrier Tape

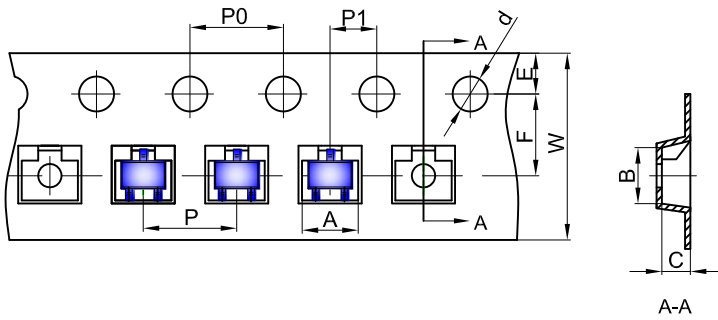

### Packaging Description:

SOT-323 parts are shipped in tape. The carrier tape is made from a dissipative (carbon filled) polycarbonate resin. The cover tape is a multilayer film (Heat Activated Adhesive in nature) primarily composed of polyester film, adhesive layer, sealant, and anti-static sprayed agent. These reeled parts in standard option are shipped with 3,000 units per 7" or 17.8cm diameter reel. The reels are clear in color and is made of polystyrene plastic (anti-static coated).

Dimensions are in millimeter										
Pkg type	A	B	C	d	E	F	P0	P	P1	W
SOT-323	2.25	2.55	1.19	Ø1.55	1.75	3.50	4.00	4.00	2.00	8.00

## SOT-323 Tape Leader and Trailer

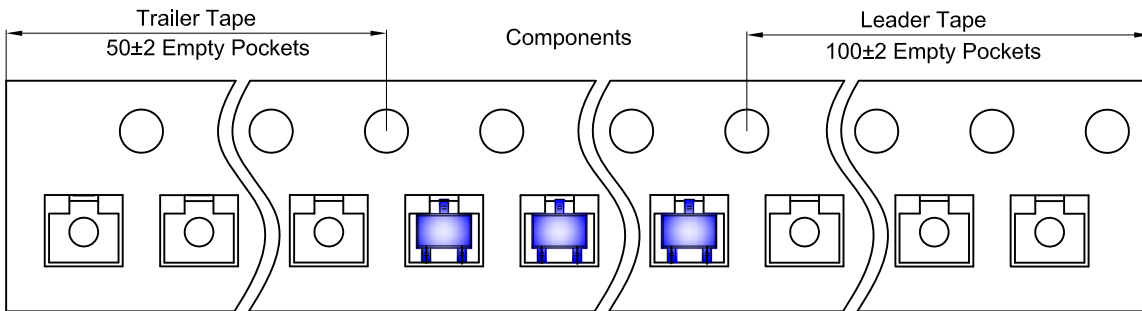

## SOT-323 Reel

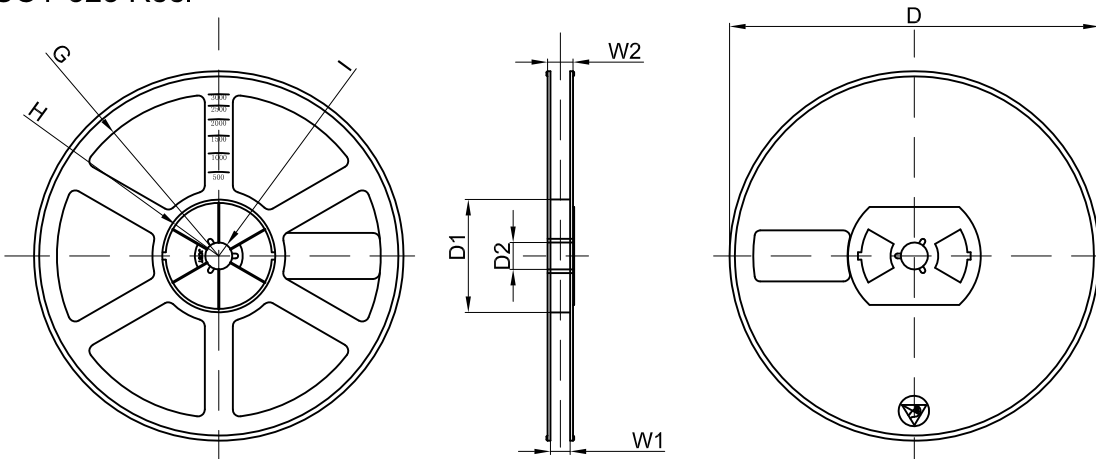

Dimensions are in millimeter								
Reel Option	D	D1	D2	G	H	I	W1	W2
7" Dia	Ø178.00	54.40	13.00	R78.00	R25.60	R6.50	9.50	12.30

REEL	Reel Size	Box	Box Size(mm)	Carton	Carton Size(mm)	G.W.(kg)
3000 pcs	7 inch	45,000 pcs	203×203×195	180,000 pcs	438×438×220	