

Metal Oxide Varistors (MOV) Data Sheet

Features

- Wide operating voltage (V_{1mA}) range from 18V to 750V
- Fast responding to transient over-voltage
- Large absorbing transient energy capability
- Low clamping ratio and no follow-on current
- Meets MSL level 1, per J-STD-020
- Operating Temperature : $-40^{\circ}\text{C} \sim +105^{\circ}\text{C}$
- Storage Temperature : $-40^{\circ}\text{C} \sim +125^{\circ}\text{C}$
- Safety certification : UL 、 CSA 、 VDE



Applications

- Transistor, diode, IC, thyristor or triac semiconductor protection
- Surge protection in consumer electronics
- Surge protection in industrial electronics
- Surge protection in electronic home appliances, gas and petroleum appliances
- Relay and electromagnetic valve surge absorption

Part Number Code

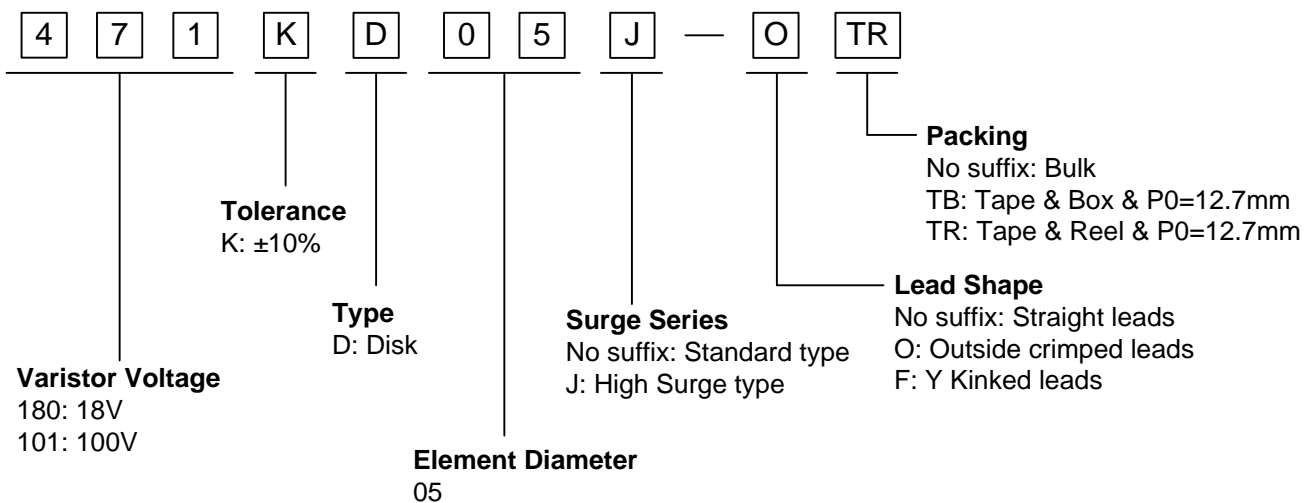

Dimensions

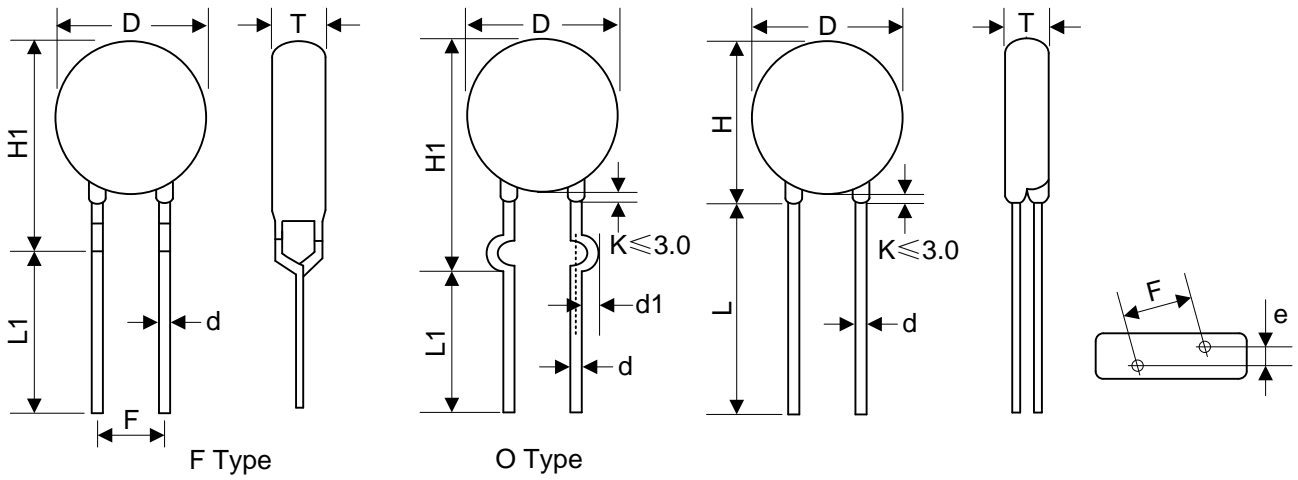

Table 1	
Unit: mm	
Symbol	Dimension
H	5.5~10.0
H1	8.0~13.0
L(min.)	20.0
L1(min.)	15.0
D	5.0~7.5
F(±0.8)	5.0
T	Table 2
e(±0.8)	Table 2
d(±0.05)	0.6
d1(±0.4)	1.2

Table 2					
Unit: mm					
Model	T	e	Model	T	e
180K	1.5~4.5	1.3	221K	2.0~4.5	1.9
220K	1.6~4.6	1.4	241K	2.1~4.6	2.0
270K	1.6~4.7	1.6	271K	2.1~4.9	2.2
330K	1.7~4.9	1.5	301K	2.2~5.0	2.3
390K	1.6~4.8	1.6	331K	2.2~5.1	2.3
470K	1.7~4.9	1.7	361K	2.4~5.2	2.5
560K	1.8~5.0	1.9	391K	2.5~5.4	2.6
680K	1.9~5.2	2.2	431K	2.7~5.7	2.8
820K	1.6~4.1	1.6	471K	2.8~6.0	3.0
101K	1.9~4.3	1.8	511K	2.9~6.2	3.2
121K	1.9~4.5	2.0	561K	3.1~6.5	3.4
151K	1.7~4.8	1.6	621K	3.3~6.5	3.7
181K	1.8~4.3	1.7	681K	3.5~6.8	4.0
201K	1.9~4.4	1.8	751K	3.8~6.9	4.1

Electrical Characteristics

Part Number		Maximum Allowable Voltage		Varistor Voltage	Maximum Clamping Voltage		Withstanding Surge Current		Maximum Energy (10/1000μs)		Rated Power	Typical Capacitance (Reference)
Standard	High Surge	V _{AC} (V)	V _{DC} (V)	V _{1mA} (V)	I _P (A)	V _C (V)	I (A) Standard	I (A) High Surge	(J) Standard	(J) High Surge	(W)	@1KHz (pf)
180KD05	180KD05J	11	14	18(15~21.6)	1	40	100	250	0.4	0.6	0.01	1400
220KD05	220KD05J	14	18	22(19.5~26)	1	48	100	250	0.5	0.7	0.01	1150
270KD05	270KD05J	17	22	27(24~31)	1	60	100	250	0.6	0.9	0.01	930
330KD05	330KD05J	20	26	33(29.5~36.5)	1	73	100	250	0.8	1.1	0.01	760
390KD05	390KD05J	25	31	39(35~43)	1	80	100	250	0.9	1.2	0.01	640
470KD05	470KD05J	30	38	47(42~52)	1	104	100	250	1.1	1.5	0.01	530
560KD05	560KD05J	35	45	56(50~62)	1	123	100	250	1.3	1.8	0.01	450
680KD05	680KD05J	40	56	68(61~75)	1	145	100	250	1.6	2.2	0.01	370
820KD05	820KD05J	50	65	82(74~90)	5	150	400	800	2.5	4.0	0.1	300
101KD05	101KD05J	60	85	100(90~110)	5	177	400	800	3.0	4.1	0.1	250
121KD05	121KD05J	75	100	120(108~132)	5	210	400	800	4.0	4.9	0.1	210
151KD05	151KD05J	95	125	150(135~165)	5	260	400	800	4.1	6.5	0.1	165
181KD05	181KD05J	115	150	180(162~198)	5	320	400	800	4.9	7.5	0.1	140
201KD05	201KD05J	130	170	200(180~220)	5	355	400	800	6.5	8.5	0.1	125
221KD05	221KD05J	140	180	220(198~242)	5	380	400	800	7.5	9.0	0.1	110
241KD05	241KD05J	150	200	240(216~264)	5	415	400	800	8.0	10.5	0.1	100
271KD05	271KD05J	175	225	270(243~297)	5	475	400	800	8.5	11.0	0.1	95
301KD05	301KD05J	190	250	300(270~330)	5	520	400	800	9.0	12.0	0.1	85
331KD05	331KD05J	210	275	330(297~363)	5	570	400	800	9.5	13.0	0.1	75
361KD05	361KD05J	230	300	360(324~396)	5	620	400	800	10.0	16.0	0.1	70
391KD05	391KD05J	250	320	390(351~429)	5	675	400	800	12.0	17.0	0.1	65
431KD05	431KD05J	275	350	430(387~473)	5	745	400	800	13.0	20.0	0.1	60
471KD05	471KD05J	300	385	470(423~517)	5	810	400	800	15.0	21.0	0.1	55
511KD05	511KD05J	320	415	510(459~561)	5	845	400	800	16.0	22.5	0.1	50
561KD05	561KD05J	350	460	560(504~616)	5	920	400	800	16.8	24.0	0.1	45
621KD05	621KD05J	385	505	620(558~682)	5	1025	400	800	17.7	25.0	0.1	40
681KD05	681KD05J	420	560	680(612~748)	5	1120	400	800	21.0	29.0	0.1	35
751KD05	751KD05J	460	615	750(675~825)	5	1240	400	800	22.4	32.0	0.1	30

Notes: 1. The tolerance of varistor voltage between 18V and 27V is more than 10%.

2. Leakage Current (@83% of V_{1mA}) : IR≤50μA (180K~680K) ; IR≤25μA (820K~751K)

Maximum Surge Current Derating Curve

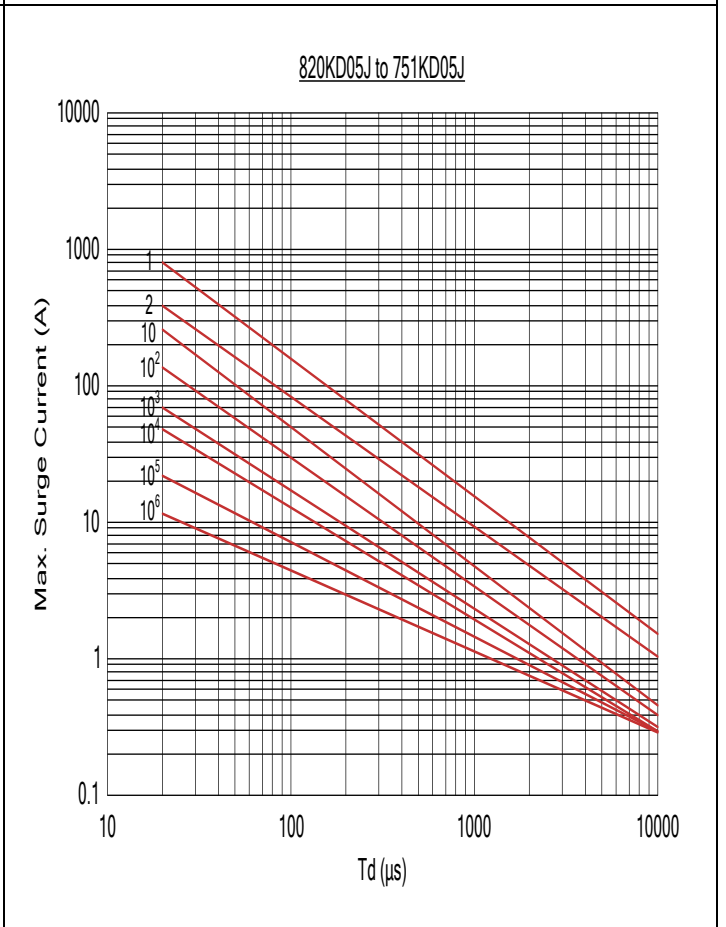
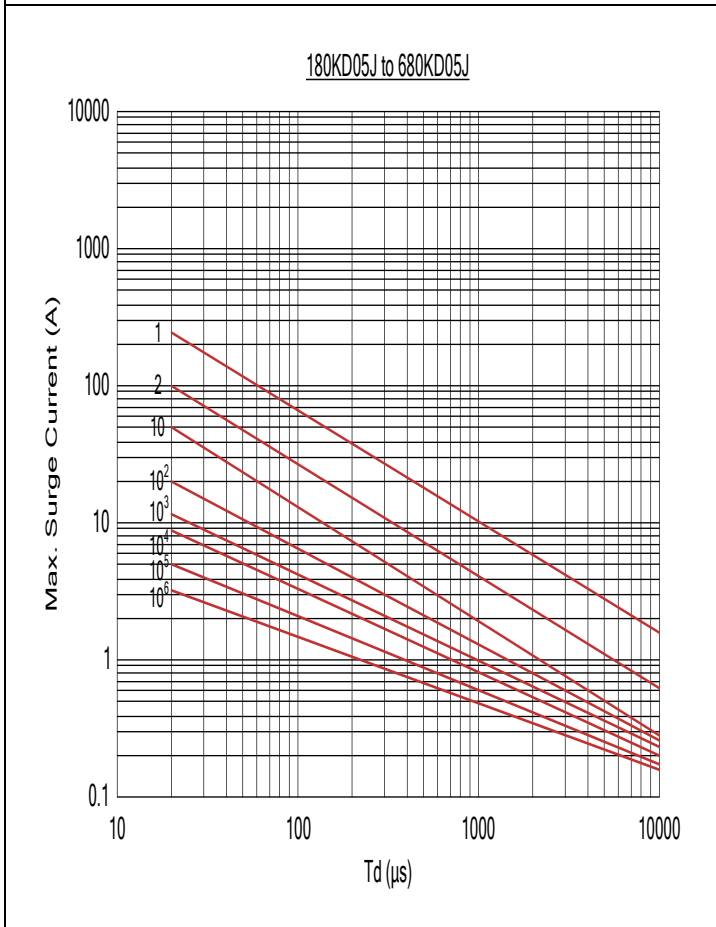
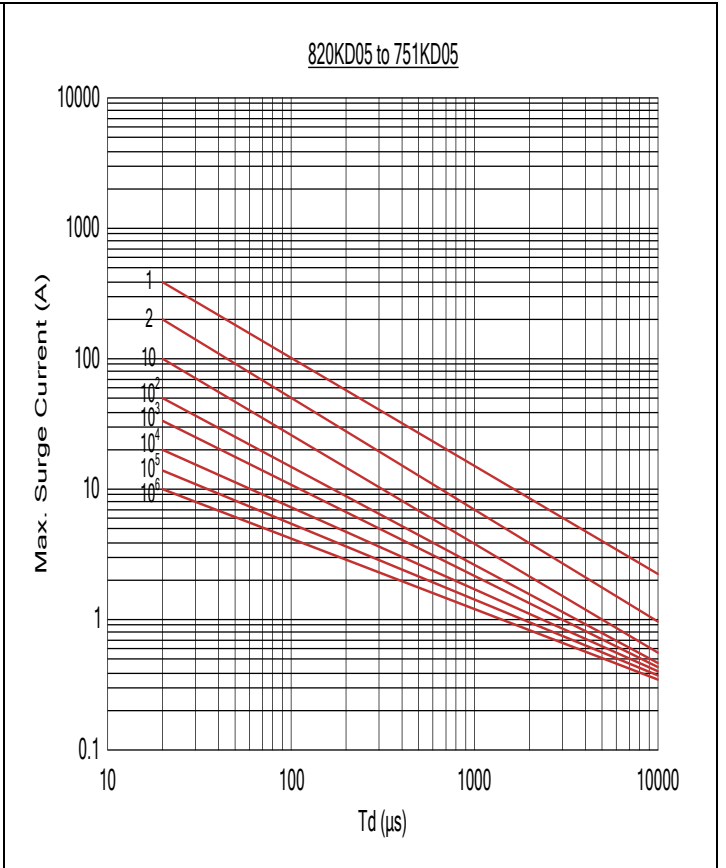
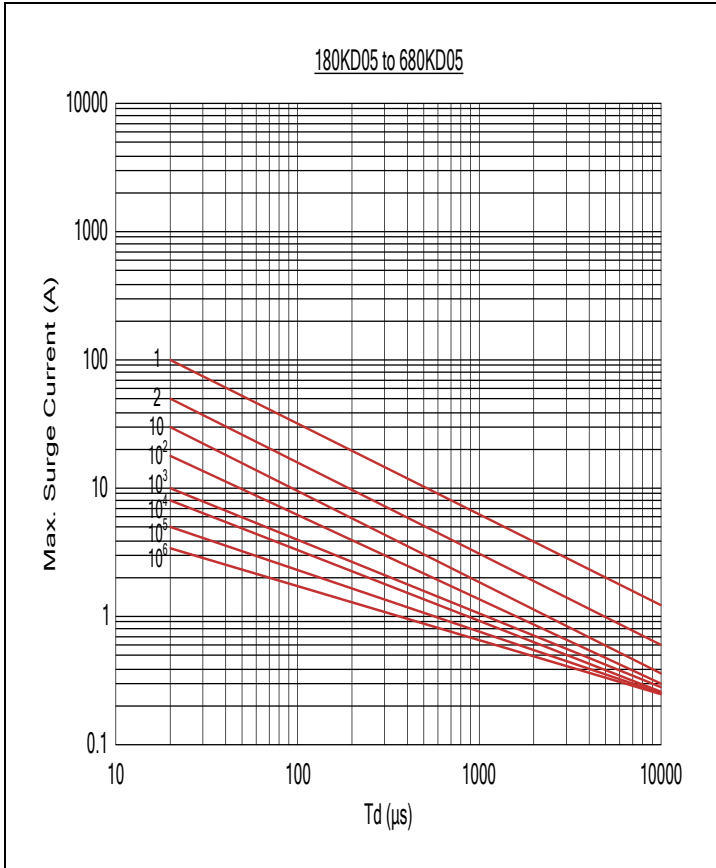

Maximum Leakage Current and Maximum Clamping Voltage Curve

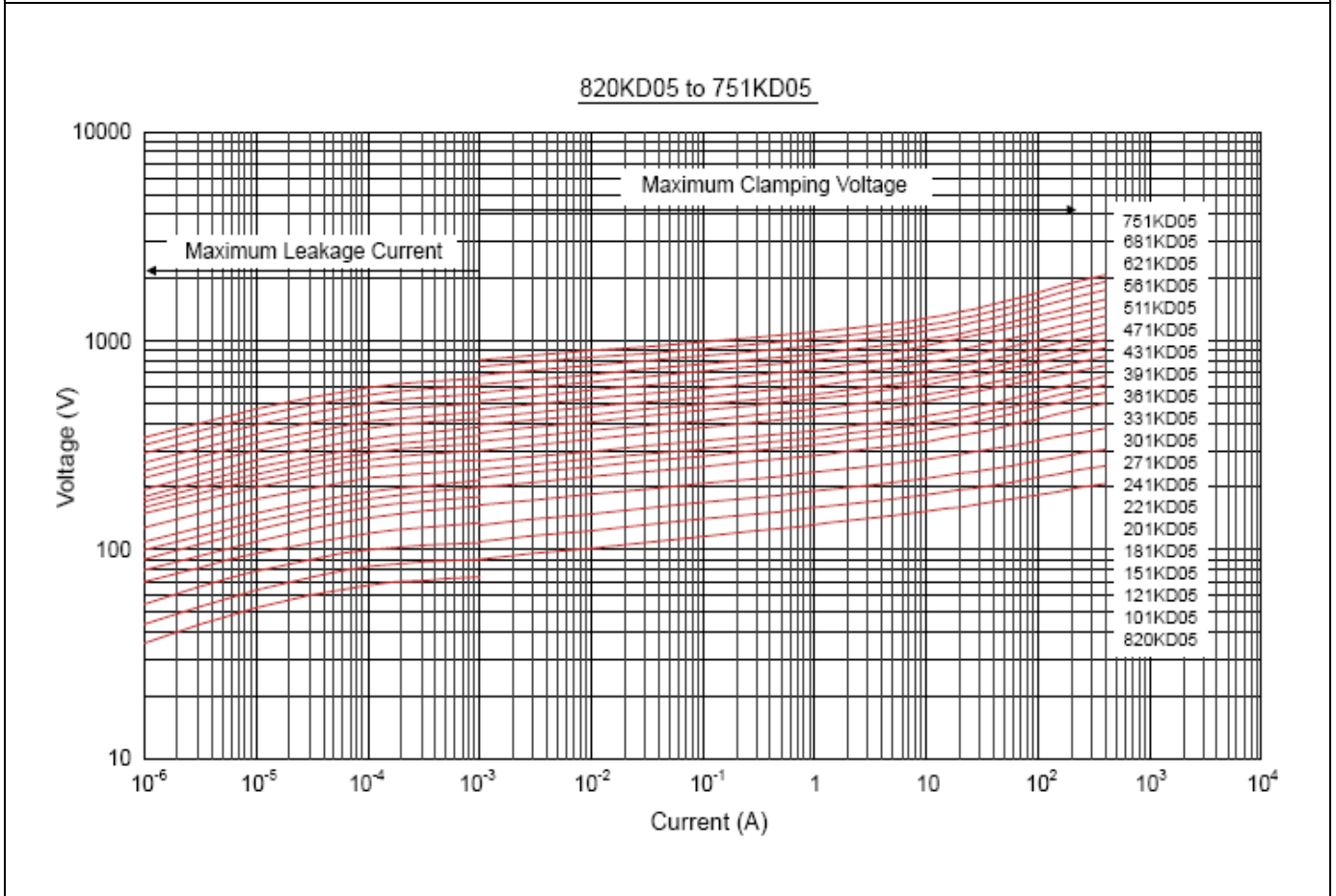
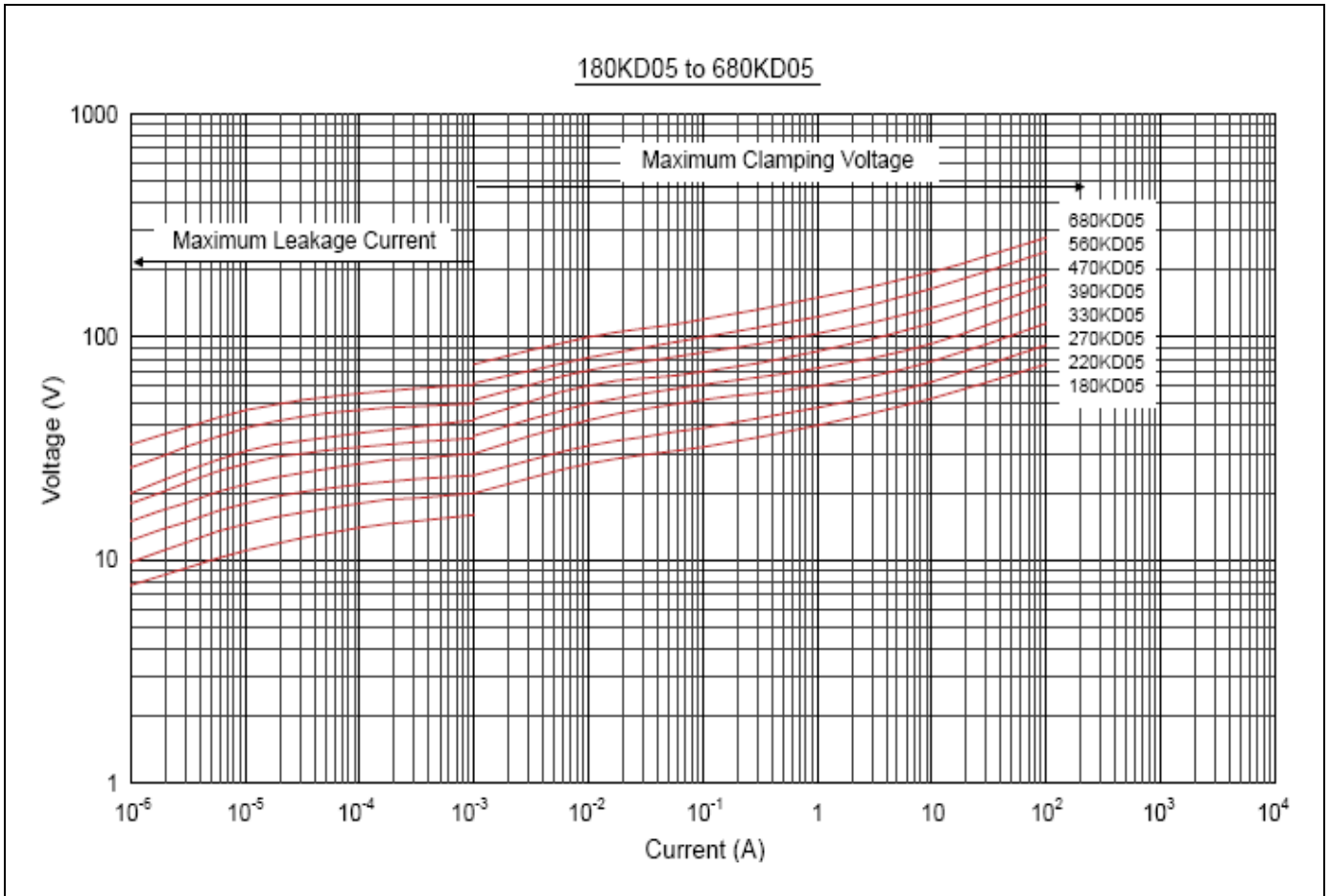

Maximum Leakage Current and Maximum Clamping Voltage Curve

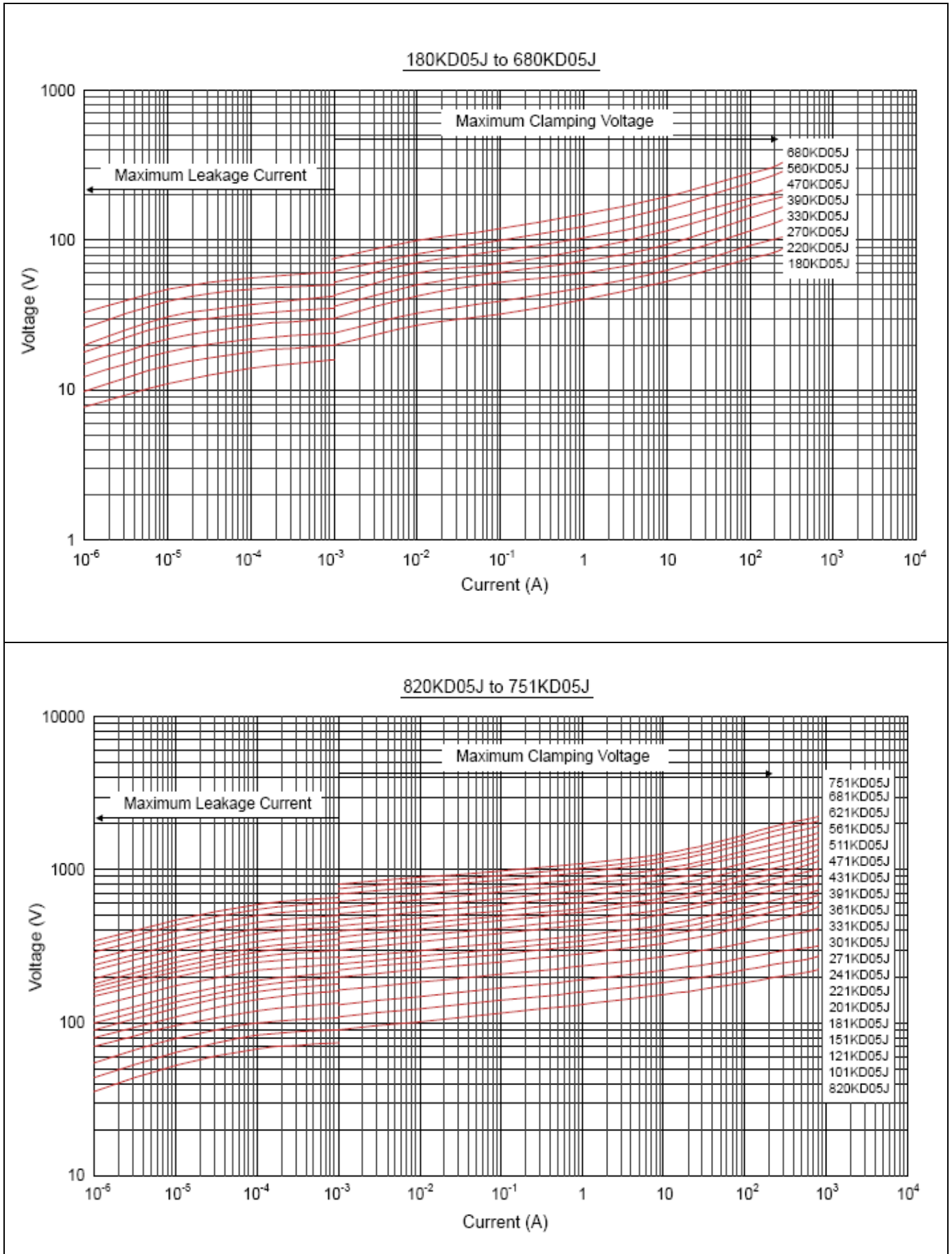

Reliability

Items	Standard	Test conditions / Methods	Specifications															
Tensile Strength of Terminals	IEC60068-2-21	Gradually applying the force specified and keeping the unit fixed for 10±1 sec. <table border="1"> <thead> <tr> <th>Terminal diameter (mm)</th> <th>Force (kg)</th> </tr> </thead> <tbody> <tr> <td>0.5 < d ≤ 0.8</td> <td>1.0</td> </tr> <tr> <td>0.8 < d ≤ 1.25</td> <td>2.0</td> </tr> <tr> <td>1.25 < d</td> <td>4.0</td> </tr> </tbody> </table>	Terminal diameter (mm)	Force (kg)	0.5 < d ≤ 0.8	1.0	0.8 < d ≤ 1.25	2.0	1.25 < d	4.0	No visible damage ΔV _{1mA} /V _{1mA} ≤ 5%							
Terminal diameter (mm)	Force (kg)																	
0.5 < d ≤ 0.8	1.0																	
0.8 < d ≤ 1.25	2.0																	
1.25 < d	4.0																	
Bending Strength of Terminals	IEC60068-2-21	Hold specimen and apply the force specified below to each lead. Bend the specimen to 90°, then return to the original position. Repeat the procedure in the opposite direction. <table border="1"> <thead> <tr> <th>Terminal diameter (mm)</th> <th>Force (kg)</th> </tr> </thead> <tbody> <tr> <td>0.5 < d ≤ 0.8</td> <td>0.5</td> </tr> <tr> <td>0.8 < d ≤ 1.25</td> <td>1.0</td> </tr> <tr> <td>1.25 < d</td> <td>2.0</td> </tr> </tbody> </table>	Terminal diameter (mm)	Force (kg)	0.5 < d ≤ 0.8	0.5	0.8 < d ≤ 1.25	1.0	1.25 < d	2.0	No visible damage ΔV _{1mA} /V _{1mA} ≤ 5%							
Terminal diameter (mm)	Force (kg)																	
0.5 < d ≤ 0.8	0.5																	
0.8 < d ≤ 1.25	1.0																	
1.25 < d	2.0																	
Vibration	IEC60068-2-6	Frequency range: 10~55 Hz Amplitude: 0.75mm or 98m/s ² Direction: 3 mutually perpendicular directions, 2hrs each.	No visible damage ΔV _{1mA} /V _{1mA} ≤ 5%															
Solderability	IEC60068-2-20	Solder Temp: 245±5 °C Dipping Time: 2±0.5 sec	At least 95% of terminal electrode is covered by new solder															
Resistance to Soldering Heat	IEC60068-2-20	Solder Temp: 260±5 °C Dipping Time: 10±1 sec	No visible damage ΔV _{1mA} /V _{1mA} ≤ 5%															
High Temperature Storage	IEC60068-2-2	Ambient Temp: 125±2 °C Duration: 1000±24hrs	No visible damage ΔV _{1mA} /V _{1mA} ≤ 5%															
Low Temperature Storage	IEC60068-2-1	Ambient Temp: -40±2 °C Duration: 1000±24hrs	No visible damage ΔV _{1mA} /V _{1mA} ≤ 5%															
Damp Heat, Steady State	IEC60068-2-78	The test is divided into two groups . a. 40±2 °C , 90~95% RH for 1344±24hrs b. 40±2 °C , 90~95% RH, at 10%VDC , 1344±24 hrs	No visible damage ΔV _{1mA} /V _{1mA} ≤ 10% Insulation Resistance ≥ 100MΩ															
High Temperature Load	MIL-STD-202 Method 108	Ambient Temp: 105±2 °C Duration: 1000±24hrs Load: Max. Allowable Voltage In AC.	ΔV _{1mA} /V _{1mA} ≤ 10%															
Temperature Cycle	IEC60068-2-14	The conditions shown below shall be repeated 5 cycles <table border="1"> <thead> <tr> <th>Step</th> <th>Temperature (°C)</th> <th>Period (minutes)</th> </tr> </thead> <tbody> <tr> <td>1</td> <td>-40±3</td> <td>30±3</td> </tr> <tr> <td>2</td> <td>Room temperature</td> <td>5±3</td> </tr> <tr> <td>3</td> <td>125±3</td> <td>30±3</td> </tr> <tr> <td>4</td> <td>Room temperature</td> <td>5±3</td> </tr> </tbody> </table>	Step	Temperature (°C)	Period (minutes)	1	-40±3	30±3	2	Room temperature	5±3	3	125±3	30±3	4	Room temperature	5±3	No visible damage ΔV _{1mA} /V _{1mA} ≤ 5%
Step	Temperature (°C)	Period (minutes)																
1	-40±3	30±3																
2	Room temperature	5±3																
3	125±3	30±3																
4	Room temperature	5±3																
8/20uS Surge Life	IEC61051-1	8/20μS waveform, 10 surge currents, unipolar, interval 30secs, amplitude corresponding to max. surge current derating curves for 20μS.	No visible damage ΔV _b (1mA) ≤ ±10%															
10/1000μS Surge Life	IEC61051-1	10/1000μS waveform, 10 surge currents, unipolar, interval 2mins, amplitude corresponding to max. surge current derating curves for 1000μS.	No visible damage ΔV _{1mA} /V _{1mA} ≤ 10%															
Voltage Proof	IEC61051-1	Metal balls method, 2500Vac 1 min.	No visible damage															

Soldering Recommendation

Lead-free Wave Soldering Recommendation

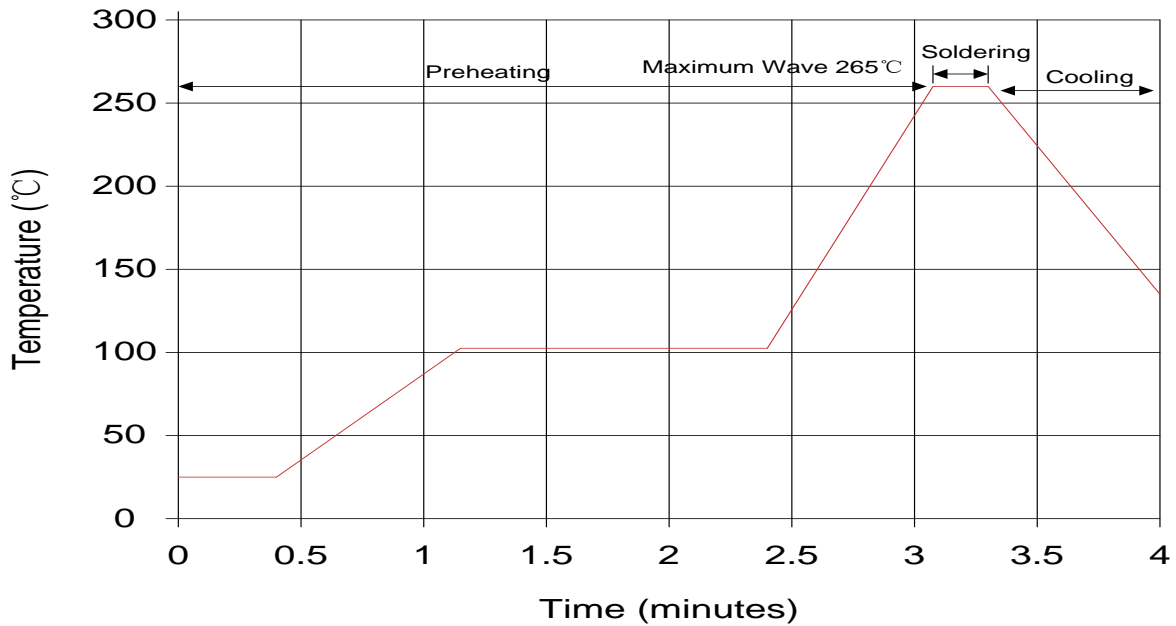

Item	Conditions
Peak Temperature	265°C
Dipping Time	10 seconds (max.)
Soldering	1 time

Recommendation Reworking Conditions with Soldering Iron

Item	Conditions
Temperature of Soldering Iron-tip	360°C (max.)
Soldering Time	3 seconds (max.)
Distance from Varistor	2mm (min.)

Marking Code

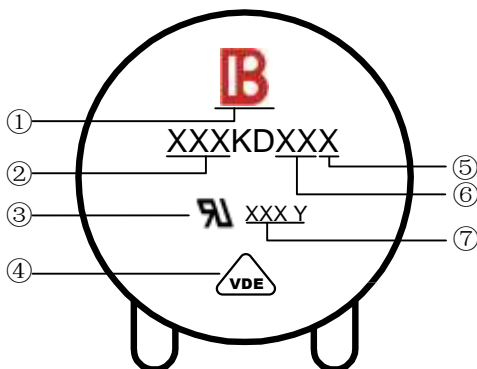

- ① Brightking Logo
- ② Varistor Voltage
- ③ UL Accreditation Logo
- ④ VDE Accreditation Logo
- ⑤ “J” is High Surge Code, no “J” is Standard Surge
- ⑥ Disk Size
- ⑦ Internal control code

Taping Dimensions

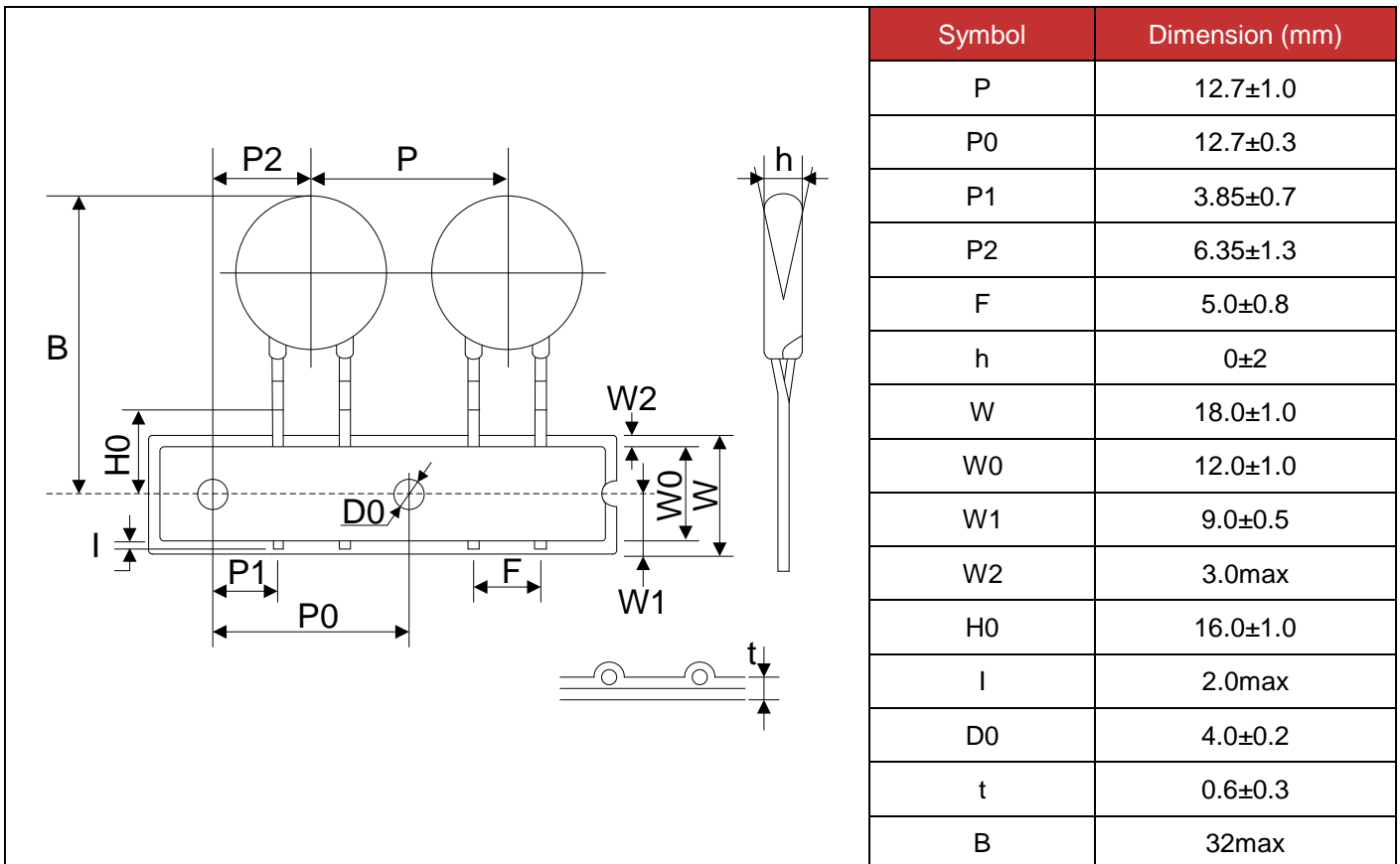
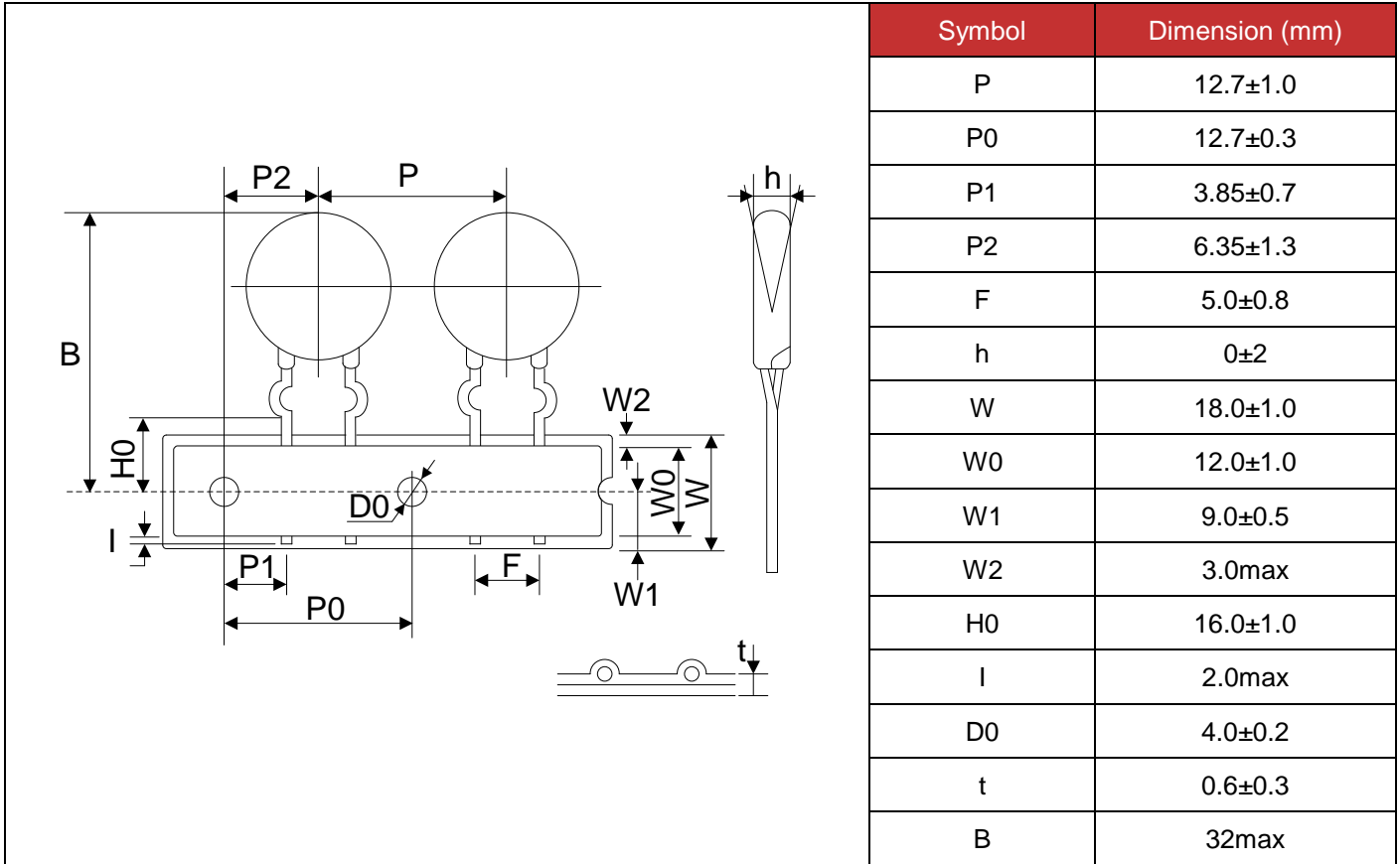

Taping Dimensions

	Symbol	Dimension (mm)
	P	12.7±1.0
	P0	12.7±0.3
	P1	3.85±0.7
	P2	6.35±1.3
	F	5.0±0.8
	h	0±2
	W	18.0±1.0
	W0	12.0±1.0
	W1	9.0±0.5
	W2	3.0max
	H2	20.0±2.0
	I	2.0max
	D0	4.0±0.2
	t	0.6±0.3
B	32max	

Quantity

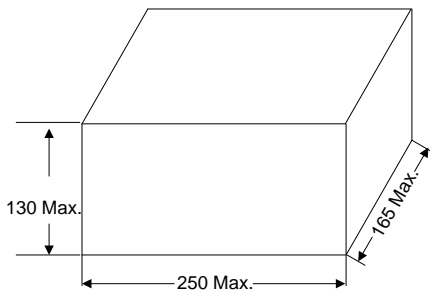
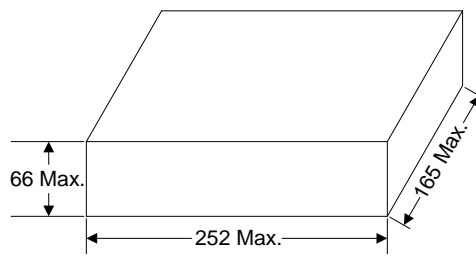
Packaging Dimensions (Unit: mm)	Quantity
<p>In bulk for Terminals Untrimmed Products</p> 	<p>1000pcs/bag 4bags/box (180K~751K)</p>
<p>In bulk for Terminals Trimmed Products</p> 	<p>1000pcs/bag 4bags/box (180K~751K)</p>

Quantity

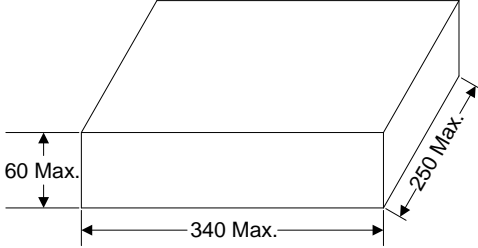
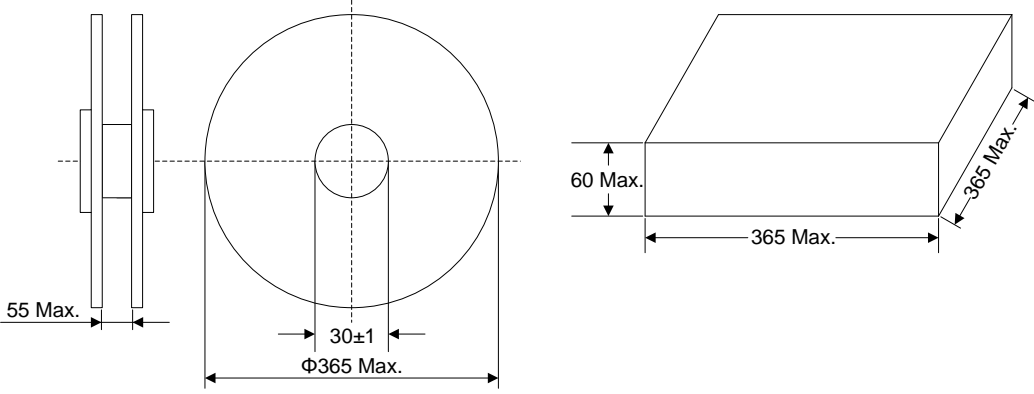
Packaging Dimensions (Unit: mm)	Quantity
<p>Tape & Box & P0=12.7mm</p> 	<p>1500pcs/box (180K~391K)</p>
<p>Tape & Reel & P0=12.7mm</p> 	<p>2000pcs/reel (180K~391K)</p> <p>1500pcs/reel (431K~751K)</p>

Storage Condition of Products

(I) Storage Conditions :

- 1.Storage Temperature : -10°C ~ +40°C
- 2.Relative Humidity : ≦ 80%RH
- 3.Keep away from corrosive atmosphere and sunlight.

(II) Period of Storage : 1 year