

RoHS Compliant

■ Features

- Kyocera's series of Multilayer Ceramic Chip Capacitors are designed to meet a wide variety of needs. We offer a complete range of products for both general and specialized applications.
- We have a network worldwide in order to supply our global customer bases quickly and efficiently.
- All our products are highly reliable due to their monolithic structure of high-purity and superfine uniform ceramics and their integral internal electrodes.
- By combining superior manufacturing technology and materials with high dielectric constants, we produce extremely compact components with exceptional specifications.
- Our stringent quality control in every phase of production from material procurement to shipping ensures consistent manufacturing and superior quality.
- Kyocera components are available in a wide choice of dimensions, temperature characteristics, rated voltages, and terminations to meet specific configurational requirements.

■ KYOCERA PART NUMBER

CM 03 X5R 225 M 06 A H □□□
 ① ② ③ ④ ⑤ ⑥ ⑦ ⑧ OPTION :

Above digits are used to track individual specification or thickness.

(Example)

- ① Series : CM Series (General)
- ② Size : 0201
- ③ Dielectric : X5R
- ④ Capacitance : 2.2μF
- ⑤ Tolerance : ±20%
- ⑥ Voltage : 6.3Vdc
- ⑦ Termination : Sn
- ⑧ Packaging : Cavity pitch 2mm / Reel Size φ180

① SERIES CODE

| CODE | Type |
|------|---------------------------|
| CM | General |
| CT | Low Profile |
| CU | High-Q |
| KNH | Three Terminal Capacitors |

② SIZE CODE

| CODE | EIA | JIS |
|------|-------|------|
| 02 | 01005 | 0402 |
| 03 | 0201 | 0603 |
| 05 | 0402 | 1005 |
| 105 | 0603 | 1608 |
| 21 | 0805 | 2012 |
| 316 | 1206 | 3216 |
| 32 | 1210 | 3225 |

③ DIELECTRIC CODE

| Temperature Compensation Type | | | |
|-------------------------------|------------------------|--------|-----|
| CODE | Temperature Range (°C) | ppm/°C | |
| CG | -55 to 125 | 0 | ±30 |
| CH | | | ±60 |

- All parts of COG will be marked as "CG" but will conform to the above table.
- Temperature coefficients are determined by calculation based on measurement at 20°C and 85°C.

| High Dielectric Constant Type | | | |
|-------------------------------|------------------------|-------------|---------------------------|
| CODE | Temperature Range (°C) | ΔC max. (%) | Standard Temperature (°C) |
| X5R | -55 to 85 | ±15 | 25 |
| X6S | -55 to 105 | ±22 | |
| X6T | | +22/-33 | |
| X7R | | ±15 | |
| X7S | -55 to 125 | ±22 | |
| X7T | | +22/-33 | |

④ CAPACITANCE CODE

Capacitance expressed in pF.
Two significant digits plus number of zeros.
For Values < 10pF, Letter R denotes decimal point,
<1,000pF=1nF, 1,000nF=1μF>

(Example)

| CODE | Capacitance |
|------|-------------|
| R50 | 0.5pF |
| 1R0 | 1pF |
| 100 | 10pF |
| 101 | 100pF |
| 102 | 1nF |
| 103 | 10nF |
| 104 | 100nF |
| 105 | 1μF |
| 106 | 10μF |

| E STANDARD NUMBER | | | | | |
|-------------------|-------------|-------------------|-----|-----|-----|
| CODE | Capacitance | E STANDARD NUMBER | | | |
| | | E3 | E6 | E12 | E24 |
| 1.0 | 1.0 | 1.0 | 1.2 | 1.2 | 1.3 |
| | | 1.5 | 1.5 | 1.6 | 1.6 |
| | 2.2 | 2.2 | 2.2 | 2.2 | 2.4 |
| | | 2.7 | 2.7 | 2.7 | 3.0 |
| 4.7 | 3.3 | 3.3 | 3.3 | 3.6 | 3.6 |
| | | 3.9 | 3.9 | 4.3 | 4.3 |
| | 4.7 | 4.7 | 4.7 | 5.1 | 5.1 |
| 6.8 | 5.6 | 5.6 | 6.2 | 6.2 | 6.2 |
| | 6.8 | 6.8 | 7.5 | 7.5 | 7.5 |
| | | 8.2 | 8.2 | 9.1 | 9.1 |

⑤ TOLERANCE CODE

| Temperature Compensation Type (COG) | |
|-------------------------------------|-----------|
| CODE | Tolerance |
| A* | ±0.05pF |
| B | ±0.1pF |
| C | ±0.25pF |
| D | ±0.5pF |
| G* | ±2% |
| J | ±5% |
| K | ±10% |

* : Option

⑥ VOLTAGE CODE

| CODE | Rated Voltage |
|------|---------------|
| 04 | 4Vdc |
| 06 | 6.3Vdc |
| 10 | 10Vdc |
| 16 | 16Vdc |
| 25 | 25Vdc |
| 35 | 35Vdc |
| 50 | 50Vdc |
| 100 | 100Vdc |

⑦ TERMINATION CODE

| CODE | Termination |
|------|---------------------|
| A | Nickel Barrier/ Tin |

• Please contact us if Au termination is needed.

⑧ PACKAGING CODE

| CODE | Size Code | Cavity pitch | Reel size |
|------|-----------|--------------|-----------|
| T | 105 to 32 | 4mm | φ180 |
| H | 02 to 05 | 2mm | |
| Q | 03/05 | 1mm | |
| P | 02 | 1mm | φ330 |
| L | 105 to 32 | 4mm | |
| N | 02 to 05 | 2mm | |
| W | 03/05 | 1mm | |

| High Dielectric Constant Type (X5R/X6S/X6T/X7R/X7S/X7T) | |
|---|-----------|
| CODE | Tolerance |
| J* | ±5% |
| K | ±10% |
| M | ±20% |

* : Option



Dimension

CM/CT/CU Series

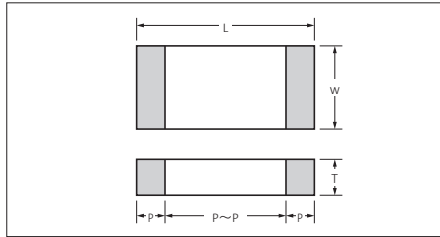

Packaging Code

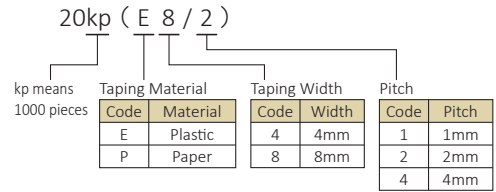

| Size | Code | | Dimension Code | Dimension (mm) | | | | | | Quantity per reel | |
|------|-------|------|----------------|----------------|-----------|-----------|--------|--------|-------------|--|--|
| | EIA | JIS | | L | W | T | P min. | P max. | P to P min. | φ180 Reel | φ330 Reel |
| 02 | 01005 | 0402 | A | 0.4±0.02 | 0.2±0.02 | 0.2±0.02 | 0.07 | 0.14 | 0.13 | 40kp(E4/1) 20kp(P8/2) | — 80kp(P8/2) |
| 03 | 0201 | 0603 | A | 0.6±0.03 | 0.3±0.03 | 0.22 max. | 0.10 | 0.20 | 0.20 | 30kp(P8/1) 15kp(P8/2) | 150kp(P8/1) 50kp(P8/2) |
| | | | B | | | 0.3±0.03 | | | | | |
| | | | C | | | 0.3±0.05 | | | | | |
| | | | D | | | 0.25 max. | | | | | |
| | | | E | | | 0.3±0.09 | | | | | |
| | | | F | | | 0.3±0.05 | | | | | |
| 05 | 0402 | 1005 | A | 1.0±0.05 | 0.5±0.05 | 0.22 max. | 0.15 | 0.35 | 0.30 | 20kp(P8/1) 10kp(P8/2) | 100kp(P8/1) 50kp(P8/2) |
| | | | B | | | 0.33 max. | | | | | |
| | | | C | | | 0.5±0.05 | | | | | |
| | | | D | | | 0.5±0.15 | | | | | |
| | | | E | | | 0.33 max. | | | | | |
| | | | F | | | 0.55 max. | | | | | |
| | | | G | | | 0.5±0.20 | | | | | |
| | | | H | | | 0.80 max. | | | | | |
| 105 | 0603 | 1608 | A | 1.6±0.10 | 0.8±0.10 | 0.55 max. | 0.20 | 0.60 | 0.50 | 4kp(P8/4) | 10kp(P8/4) |
| | | | B | | | 0.8±0.10 | | | | | |
| | | | C | | | 0.8±0.15 | | | | | |
| | | | D | | | 0.8±0.20 | | | | | |
| | | | E | | | 0.8±0.25 | | | | | |
| 21 | 0805 | 2012 | A | 2.0±0.10 | 1.25±0.10 | 0.95 max. | 0.20 | 0.75 | 0.70 | 4kp(P8/4) 3kp(E8/4) 4kp(P8/4) 3kp(E8/4) | 10kp(P8/4) 10kp(E8/4) 10kp(P8/4) 10kp(E8/4) |
| | | | B | | | 1.25±0.10 | | | | | |
| | | | C | | | 0.95 max. | | | | | |
| | | | D | | | 1.25±0.15 | | | | | |
| | | | E | | | 0.95 max. | | | | | |
| | | | F | | | 1.25±0.20 | | | | | |
| | | | | | | 1.25±0.20 | | | | | |
| 316 | 1206 | 3216 | A | 3.2±0.20 | 1.6±0.15 | 0.30 | 0.85 | 1.40 | 2.5kp(E8/4) | 5kp(E8/4) | |
| | | | B | | 1.6±0.20 | | | | | | |
| | | | C | | 1.6±0.30 | | | | | | |
| 32 | 1210 | 3225 | A | 3.2±0.30 | 2.5±0.20 | 2.5±0.20 | 0.30 | 1.00 | 1.40 | 1kp(E8/4) | 4kp(E8/4) |

KNH Series

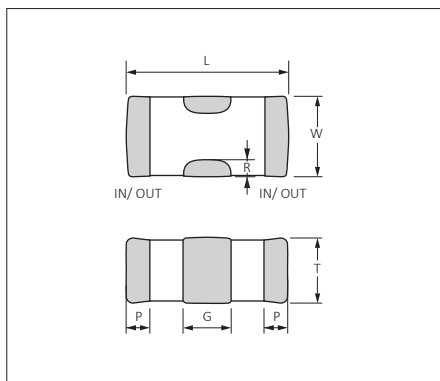

| Size | Code | | Dimension Code | Dimension (mm) | | | | | | Packaging | |
|--------|------|------|----------------|----------------|----------|----------|----------|-----------|-------|------------|-----------|
| | EIA | JIS | | L | W | T | G | P | R | φ180 Reel | φ330 Reel |
| KNH 05 | 0402 | 1005 | A | 1.0±0.10 | 0.5±0.20 | 0.5 max. | 0.3±0.10 | 0.15±0.10 | ≥0.05 | 10kp(P8/2) | — |
| | | | B | | | 0.5±0.15 | | | | | |
| | | | C | | | 0.5±0.20 | | | | | |



■ Features

We offer a diverse product line ranging from ultra-compact (0.4×0.2mm) to large (3.2×2.5mm) components configured for a variety of temperature characteristics, rated voltages, and packages. We offer the choice and flexibility for almost any applications.

■ Applications

This standard type is ideal for use in a wide range of applications, from commercial to industrial equipment.

Temperature Compensation Dielectric

● Capacitance chart Standard Spec.1

| Size (EIA Code) | Rated Voltage (Vdc) Capacitance | CM02 (01005) | | CM03 (0201) |
|--------------------|------------------------------------|-----------------|----|----------------|
| | | 16 | 25 | 50 |
| 1R0 | 1.0 pF | | | |
| 1R5 | 1.5 pF | | | |
| 2R0 | 2.0 pF | | | |
| 3R0 | 3.0 pF | | | |
| 4R0 | 4.0 pF | | | |
| 5R0 | 5.0 pF | | | |
| 6R0 | 6.0 pF | | | |
| 7R0 | 7.0 pF | | | |
| 8R0 | 8.0 pF | | | |
| 9R0 | 9.0 pF | | | |
| 100 | 10 pF | | | |
| 120 | 12 pF | | | |
| 150 | 15 pF | | | |
| 180 | 18 pF | | | |
| 220 | 22 pF | | | |
| 270 | 27 pF | | | |
| 330 | 33 pF | | | |
| 390 | 39 pF | | | |
| 470 | 47 pF | | | |
| 560 | 56 pF | | | |
| 680 | 68 pF | | | |
| 820 | 82 pF | | | |
| 101 | 100 pF | | | |
| 121 | 120 pF | | | |
| 151 | 150 pF | | | |
| 181 | 180 pF | | | |
| 221 | 220 pF | | | |

<Standard Capacitor Value: E12 Series>

Please contact for capacitance value other than standard.

Alphabets in capacitance chart denote dimensions. Please refer to the below table for detail.

(Example) In case of "B" for CM03;
L: 0.6±0.03mm, W: 0.3±0.03mm, T: 0.3±0.03mm

| Size | Dimension Code | Dimension (mm) | | | Packaging | | | | | | | | | |
|------|----------------|----------------|----------|----------|-----------|----------|-----------------|--------------|--------------|-----------|----------|-----------------|--------------|--------------|
| | | | | | φ180 Reel | | | | | φ330 Reel | | | | |
| | | L | W | T | Code | Quantity | Taping Material | Taping Width | Cavity Pitch | Code | Quantity | Taping Material | Taping Width | Cavity Pitch |
| 02 | A | 0.4±0.02 | 0.2±0.02 | 0.2±0.02 | P | 40,000 | Plastic | 4mm | 1mm | — | — | — | — | — |
| | | | | | H | 20,000 | Paper | 8mm | 2mm | N | 80,000 | Paper | 8mm | 2mm |
| 03 | B | 0.6±0.03 | 0.3±0.03 | 0.3±0.03 | Q | 30,000 | Paper | 8mm | 1mm | W | 150,000 | Paper | 8mm | 1mm |
| | | | | | H | 15,000 | Paper | 8mm | 2mm | N | 50,000 | Paper | 8mm | 2mm |



General

CM Series

【RoHS Compliant Products】

X5R Dielectric

•Capacitance chart ■ Standard Spec.1 ■ Standard Spec.2 ▨ Optional Spec.

Capacitance chart for CM02, CM03, CM05, and CM105 series. Columns represent size codes (6.3, 10, 16, 25) and voltage codes (4, 6.3, 10, 16, 25, 35). Rows represent capacitance values from 101 pF to 226 μF. Shaded cells indicate standard specifications, and hatched cells indicate optional specifications.

Capacitance chart for CM21, CM316, and CM32 series. Columns represent size codes (6.3, 10, 16, 25, 50) and voltage codes (16, 25, 50, 100). Rows represent capacitance values from 105 μF to 476 μF. Shaded cells indicate standard specifications, and hatched cells indicate optional specifications.

Table mapping Tan δ Code to Tan δ percentage: 3 (5.0% max), 4 (7.0% max), 5 (7.5% max), 7 (10.0% max), 8 (12.5% max), 9 (15.0% max), 10 (20.0% max).

<Standard Capacitance Value>
Capacitance value of less than 0.1μF :E6 Series
Capacitance value of 0.1μF and larger :E3 Series
Please contact for capacitance value other than standard.

Two digits alphanumeric in capacitance chart denote dimensions and tan δ. Please refer to the above table for detail.

(Example) In case of "B3" for CM03;
L: 0.6±0.03mm, W: 0.3±0.03mm, T: 0.3±0.03mm, Tanδ: 5.0% max.

Table detailing dimensions (L, W, T) and packaging options (φ180 Reel and φ330 Reel) for various size codes (02, 03, 05, 105, 21, 316, 32).



X6S/X6T Dielectric

Capacitance chart Standard Spec.2 Optional Spec.

Table with columns: Size (EIA Code), CM03 (0201), CM105 (0603), CM21 (0805), X6T CM105 (0603). Rows include Rated Voltage (Vdc) and Capacitance values.

Table with columns: Tan δ Code, Tan δ. Rows: 7 (10.0% max.), 8 (12.5% max.), 9 (15.0% max.), 10 (20.0% max.).

Please contact for capacitance value other than standard.

Two digits alphanumeric in capacitance chart denote dimensions and tan δ. Please refer to the above table for detail.

(Example) In case of "D9" for CM105; L: 1.6±0.20mm, W: 0.8±0.20mm, T: 0.8±0.20mm, Tanδ: 15.0% max.

Table with columns: Size, Dimension Code, Dimension (mm) [L, W, T], Packaging [φ180 Reel, φ330 Reel] [Code, Quantity, Taping Material, Taping Width, Cavity Pitch].

X7R Dielectric

Capacitance chart Standard Spec.1 Optional Spec.

Table with columns: Size (EIA Code), CM02 (01005), CM03 (0201), CM05 (0402), CM105 (0603), CM21 (0805). Rows include Rated Voltage (Vdc) and Capacitance values.

Table with columns: Size (EIA Code), CM316 (1206), CM32 (1210). Rows include Rated Voltage (Vdc) and Capacitance values.

Table with columns: Tan δ Code, Tan δ. Rows: 2 (3.5% max.), 3 (5.0% max.), 5 (7.5% max.), 8 (12.5% max.).

<Standard Capacitance Value>

Capacitance value of less than 0.1μF: E6 Series

Capacitance value of 0.1μF and larger : E3 Series

Please contact for capacitance value other than standard.

Two digits alphanumeric in capacitance chart denote dimensions and tan δ. Please refer to the above table for detail.

(Example) In case of "B3" for CM03; L: 0.6±0.03mm, W: 0.3±0.03mm, T: 0.3±0.03mm, Tanδ: 5.0% max.

Table with columns: Size, Dimension Code, Dimension (mm) [L, W, T], Packaging [φ180 Reel, φ330 Reel] [Code, Quantity, Taping Material, Taping Width, Cavity Pitch].



General

CM Series

【RoHS Compliant Products】

X7S/X7T Dielectric

●Capacitance chart ■ Standard Spec.1 □ Standard Spec.2 ▨ Optional Spec.

| Size (EIA Code) | X7S | | | X7T | | | |
|---------------------|-------------|-------------|--------------|--------------|-------------|------|------|
| | CM05 (0402) | CM21 (0805) | CM316 (1206) | CM105 (0603) | CM21 (0805) | | |
| Rated Voltage (Vdc) | 4 | 100 | 10 | 100 | 6.3 | 10 | 6.3 |
| Capacitance | | | | | | | |
| 105 1.0 μF | ▨ C8 | ▨ F3 | | | | | |
| 225 2.2 μF | ▨ D3 | | | ▨ B3 | | | |
| 475 4.7 μF | | | | ▨ C3 | | ▨ D8 | |
| 106 10 μF | | | | | ▨ D9 | | |
| 226 22 μF | | | ■ B5 | | | | ■ F8 |

Please contact for capacitance value other than standards.

Two digits alphanumeric in capacitance chart denote dimensions and tan δ. Please refer to the above table for detail.

(Example) In case of "D9" for CM105; L: 1.6±0.20mm, W: 0.8±0.20mm, T: 0.8±0.20mm, Tanδ: 15.0% max.

| Tan δCode | Tan δ |
|-----------|------------|
| 3 | 5.0% max. |
| 5 | 7.5% max. |
| 8 | 12.5% max. |
| 9 | 15.0% max. |

| Size | Dimension Code | Dimension (mm) | | | Packaging | | | | | | | | | | |
|------|----------------|----------------|-----------|-----------|-----------|----------|-----------------|--------------|--------------|-----------|----------|-----------------|--------------|--------------|-----|
| | | L | W | T | φ180 Reel | | | | | φ330 Reel | | | | | |
| | | | | | Code | Quantity | Taping Material | Taping Width | Cavity Pitch | Code | Quantity | Taping Material | Taping Width | Cavity Pitch | |
| 05 | C | 1.0±0.05 | 0.5±0.05 | 0.5±0.05 | H | 10,000 | Paper | 8mm | 2mm | 2mm | N | 50,000 | Paper | 8mm | 2mm |
| | D | 1.0±0.15 | 0.5±0.15 | 0.5±0.15 | H | 10,000 | Paper | 8mm | 2mm | 2mm | N | 40,000 | Paper | 8mm | 2mm |
| 105 | D | 1.6±0.20 | 0.8±0.20 | 0.8±0.20 | T | 4,000 | Paper | 8mm | 4mm | 4mm | L | 10,000 | Paper | 8mm | 4mm |
| 21 | F | 2.0±0.20 | 1.25±0.20 | 1.25±0.20 | T | 3,000 | Plastic | 8mm | 4mm | 4mm | L | 10,000 | Plastic | 8mm | 4mm |
| 316 | B | 3.2±0.20 | 1.6±0.20 | 1.6±0.20 | T | 2,500 | Plastic | 8mm | 4mm | 4mm | L | 5,000 | Plastic | 8mm | 4mm |
| | C | 3.2±0.30 | 1.6±0.30 | 1.6±0.30 | T | 2,000 | Plastic | 8mm | 4mm | 4mm | — | — | — | — | — |



Test Conditions and Standards

Test Conditions and Specifications for Temperature Compensation Type (CΔ Characteristics)
CM / CU Series (Standard Spec.1)

| Test Items | | Test Conditions | Specifications | | | | | | | | | |
|----------------------------|----------------------|--|---|-------------|------|----------|-------------|--------------|----------|--------------|------------------|--|
| Capacitance Value (C) | | <table border="1"> <thead> <tr> <th>Capacitance</th> <th>Frequency</th> <th>Volt</th> </tr> </thead> <tbody> <tr> <td>C≤1000pF</td> <td>1MHz±10%</td> <td rowspan="2">0.5 to 5Vrms</td> </tr> <tr> <td>C>1000pF</td> <td>1kHz±10%</td> </tr> </tbody> </table> | Capacitance | Frequency | Volt | C≤1000pF | 1MHz±10% | 0.5 to 5Vrms | C>1000pF | 1kHz±10% | Within tolerance | |
| Capacitance | Frequency | | Volt | | | | | | | | | |
| C≤1000pF | 1MHz±10% | 0.5 to 5Vrms | | | | | | | | | | |
| C>1000pF | 1kHz±10% | | | | | | | | | | | |
| Q | | | C≥30pF : Q≥1000 C<30pF : Q≥400+20C | | | | | | | | | |
| Insulation Resistance (IR) | | Apply the rated voltage for 1minute, and measure it in normal temperature and humidity. The charge and discharge current of the capacitor must not exceed 50mA. | Over 10000MΩ or 500MΩ·μF, whichever is less | | | | | | | | | |
| Dielectric Resistance | | Apply *3 times of the rated voltage for 1 to 5 seconds. *CU02CΔR20-120/25V: twice The charge and discharge current of the capacitor must not exceed 50mA. | No problem observed | | | | | | | | | |
| Appearance | | Microscope | No problem observed | | | | | | | | | |
| Termination Strength | | Apply a sideward force of 500g (5N) to a PCB-mounted sample. note: 2N for 0201 size, and 1N for 01005 size. | No problem observed | | | | | | | | | |
| Bending Strength | | Glass epoxy PCB: Fulcrum spacing: 90mm, duration time 10 seconds. | No significant damage with 1mm bending. | | | | | | | | | |
| Vibration Test | Appearance | Vibration frequency: 10 to 55 (Hz) Amplitude: 1.5mm Sweeping condition: 10→55→10Hz/ 1 minute in X, Y and Z directions: 2 hours each, 6 hours in total. | No problem observed | | | | | | | | | |
| | ΔC | | Within Tolerance | | | | | | | | | |
| | Q | | C≥30pF : Q≥1000 C<30pF : Q≥400+20C | | | | | | | | | |
| Soldering Heat Resistant | Appearance | Soak the sample in 260°C±5°C solder for 10±0.5 seconds and place in normal temperature and humidity, and measure the sample after 24±2 hours. (Pre-heating conditions) | No problem observed | | | | | | | | | |
| | ΔC | | Within±2.5% or ±0.25pF, whichever is larger | | | | | | | | | |
| | Q | | C≥30pF : Q≥1000 C<30pF : Q≥400+20C | | | | | | | | | |
| | IR | | Over 10000MΩ or 500MΩ·μF whichever is less | | | | | | | | | |
| | Withstanding Voltage | | Resist without problem | | | | | | | | | |
| Solderability | | Soaking condition | Solder coverage : 95% min. | | | | | | | | | |
| | | <table border="1"> <thead> <tr> <th>Order</th> <th>Temperature</th> <th>Time</th> </tr> </thead> <tbody> <tr> <td>1</td> <td>80 to 100°C</td> <td>2 minutes</td> </tr> <tr> <td>2</td> <td>150 to 200°C</td> <td>2 minutes</td> </tr> </tbody> </table> | Order | Temperature | Time | 1 | 80 to 100°C | 2 minutes | 2 | 150 to 200°C | 2 minutes | |
| Order | Temperature | Time | | | | | | | | | | |
| 1 | 80 to 100°C | 2 minutes | | | | | | | | | | |
| 2 | 150 to 200°C | 2 minutes | | | | | | | | | | |
| Temperature Cycle | Appearance | (Cycle) Room temperature (3 min.)→ Lowest operation temperature (30 min.)→ Room temperature (3 min.)→ Highest operation temperature(30 min.) After 5 cycles, measure after 24±2 hours. The charge and discharge current of the capacitor must not exceed 50mA for IR and withstanding voltage measurement. | No problem observed | | | | | | | | | |
| | ΔC | | Within±2.5% or ±0.25pF, whichever is larger | | | | | | | | | |
| | Q | | C≥30pF : Q≥1000 C<30pF : Q≥400+20C | | | | | | | | | |
| | IR | | Over 10000MΩ or 500MΩ·μF, whichever is less | | | | | | | | | |
| | Withstanding Voltage | | Resist without problem | | | | | | | | | |
| Moisture Resistant Load | Appearance | After applying the rated voltage for 500+12/-0 hours in the condition of 40°C±2°C and 90 to 95%RH, allow the parts to stabilize in normal temperature and humidity for 24±2 hours, before measurement. The charge and discharge current of the capacitor must not exceed 50mA for IR measurement. | No problem observed | | | | | | | | | |
| | ΔC | | Within±7.5% or ±0.75pF, whichever is larger | | | | | | | | | |
| | Q | | C≥30pF : Q≥200 C<30pF : Q≥100+10C/ 3 | | | | | | | | | |
| | IR | | Over 500MΩ or 25MΩ·μF, whichever is less | | | | | | | | | |
| High-Temperature Load | Appearance | After applying *twice the rated voltage in the temperature of 125±3°C for 1000+12/-0 hours, measure the sample after 24±2 hours in normal temperature and humidity. The charge and discharge current of the capacitor must not exceed 50mA for IR measurement. *Applied voltages for respective products are indicated in the chart below. | No problem observed. | | | | | | | | | |
| | ΔC | | Within ±3% or ±0.3pF, whichever is larger | | | | | | | | | |
| | Q | | C≥30pF : Q≥350 10pF<C<30pF : Q≥275+5C/ 2 C<10pF : Q≥200+10C | | | | | | | | | |
| | IR | | Over 1000MΩ or 50MΩ·μF, whichever is less | | | | | | | | | |

Please ask for individual specification for the hatched range in previous chart.

Voltage to be applied in the High Temperature Load (Applied voltage is the multiple of the rated voltage)

| Applied Voltage | Rated Voltage | Products |
|-----------------|---------------|---------------|
| ×1.0 | 16V | CM02CΔ221 |
| ×1.2 | 25V | CM02CΔR20-120 |



Test Conditions and Standards

Test Conditions and Specifications for High Dielectric Type (X5R, X7R, X7S) CM / CT Series (Standard Spec.1)

| Test Items | | Test Conditions | Specifications | | | | | | | | | |
|----------------------------|----------------------|---|---|-------------|------|--------|-------------|-------------|--------|--------------|-------------|----------------------------|
| Capacitance Value (C) | | Measure after heat treatment | Within tolerance | | | | | | | | | |
| Tanδ | | <table border="1"> <thead> <tr> <th>Capacitance</th> <th>Frequency</th> <th>Volt</th> </tr> </thead> <tbody> <tr> <td>C≤10μF</td> <td>1kHz±10%</td> <td>1.0±0.2Vrms</td> </tr> <tr> <td>C>10μF</td> <td>120Hz±10%</td> <td>0.5±0.2Vrms</td> </tr> </tbody> </table> <p>The charge and discharge current of the capacitor must not exceed 50mA.</p> | Capacitance | Frequency | Volt | C≤10μF | 1kHz±10% | 1.0±0.2Vrms | C>10μF | 120Hz±10% | 0.5±0.2Vrms | Refer to capacitance chart |
| Capacitance | Frequency | Volt | | | | | | | | | | |
| C≤10μF | 1kHz±10% | 1.0±0.2Vrms | | | | | | | | | | |
| C>10μF | 120Hz±10% | 0.5±0.2Vrms | | | | | | | | | | |
| Insulation Resistance (IR) | | Apply the rated voltage for 1 minute, and measure it in normal temperature and humidity. The charge and discharge current of the capacitor must not exceed 50mA. | Over 10000MΩ or 500MΩ·μF, whichever is less | | | | | | | | | |
| Dielectric Resistance | | Apply 2.5 times of the rated voltage for 1 to 5 seconds. The charge and discharge current of the capacitor must not exceed 50mA. | No problem observed | | | | | | | | | |
| Appearance | | Microscope | No problem observed | | | | | | | | | |
| Termination Strength | | Apply a sideward force of 500g (5N) to a PCB-mounted sample. note : 2N for 0201 size, and 1N for 01005 size. Exclude CT series with thickness of less than 0.66mm. | No problem observed | | | | | | | | | |
| Bending Strength | | Glass epoxy PCB: Fulcrum spacing: 90mm, duration time 10 seconds. Exclude CT series with thickness of less than 0.66mm. | No significant damage with 1mm bending | | | | | | | | | |
| Vibration Test | Appearance | Take the initial value after heat treatment. Vibration frequency: 10 to 55 (Hz) Amplitude: 1.5mm Sweeping condition: 10→55→10Hz/ 1 minute in X, Y and Z directions: 2 hours each, 6 hours in total, and place in normal temperature and humidity, then measure the sample after heat treatment. | No problem observed | | | | | | | | | |
| | ΔC | | Within tolerance | | | | | | | | | |
| | Tanδ | | Within tolerance | | | | | | | | | |
| Soldering Heat Resistant | Appearance | Take the initial value after heat treatment. Soak the sample in 260°C±5°C solder for 10±0.5 seconds and place in normal temperature and humidity, and measure after heat treatment. (Pre-heating conditions) | No problem observed | | | | | | | | | |
| | ΔC | | Within±7.5% | | | | | | | | | |
| | Tanδ | | Within tolerance | | | | | | | | | |
| | IR | | Over 10000MΩ or 500MΩ·μF, whichever is less | | | | | | | | | |
| | Withstanding Voltage | | Resist without problem | | | | | | | | | |
| Solderability | | Soaking condition | Solder coverage : 95% min. | | | | | | | | | |
| | | <table border="1"> <thead> <tr> <th>Order</th> <th>Temperature</th> <th>Time</th> </tr> </thead> <tbody> <tr> <td>1</td> <td>80 to 100°C</td> <td>2 minutes</td> </tr> <tr> <td>2</td> <td>150 to 200°C</td> <td>2 minutes</td> </tr> </tbody> </table> | Order | Temperature | Time | 1 | 80 to 100°C | 2 minutes | 2 | 150 to 200°C | 2 minutes | |
| Order | Temperature | Time | | | | | | | | | | |
| 1 | 80 to 100°C | 2 minutes | | | | | | | | | | |
| 2 | 150 to 200°C | 2 minutes | | | | | | | | | | |
| Temperature Cycle | Appearance | Take the initial value after heat treatment. (Cycle) Room temperature (3 min.)→ Lowest operation temperature (30 min.)→ Room temperature (3 min.)→ Highest operation temperature(30 min.) After 5 cycles, measure after heat treatment. The charge and discharge current of the capacitor must not exceed 50mA for IR and withstanding voltage measurement. | No problem observed | | | | | | | | | |
| | ΔC | | Within±7.5% | | | | | | | | | |
| | Tanδ | | Within tolerance | | | | | | | | | |
| | IR | | Over 10000MΩ or 500MΩ·μF, whichever is less | | | | | | | | | |
| | Withstanding Voltage | | Resist without problem | | | | | | | | | |
| Moisture Resistant Load | Appearance | Take the initial value after heat treatment. After applying rated voltage for 500+12/-0 hours in the condition of 40°C±2°C and 90 to 95%RH, and place in normal temperature and humidity, then measure the sample after heat treatment. The charge and discharge current of the capacitor must not exceed 50mA for IR measurement. | No problem observed | | | | | | | | | |
| | ΔC | | Within±12.5% | | | | | | | | | |
| | Tanδ | | 200% max. of initial value | | | | | | | | | |
| | IR | | Over 500MΩ or 25MΩ·μF, whichever is less | | | | | | | | | |
| High-Temperature Load | Appearance | Take the initial value after heat treatment. After applying *twice the rated voltage at the highest operation temperature for 1000+12/-0 hours, and measure the sample after heat treatment in normal temperature and humidity. The charge and discharge current of the capacitor must not exceed 50mA for IR measurement. * Apply 1.5 times when the rated voltage is 10V or less. Applied voltages for respective products are indicated in the chart below. | No problem observed | | | | | | | | | |
| | ΔC | | Within±12.5% | | | | | | | | | |
| | Tanδ | | 200% max. of initial value | | | | | | | | | |
| | IR | | Over 1000MΩ or 50MΩ·μF, whichever is less | | | | | | | | | |
| Heat treatment | | Expose sample in the temperature of 150+0/-10°C for 1 hour and leave the sample in normal temperature and humidity for 24±2 hours. | | | | | | | | | | |

Voltage to be applied in the High Temperature Load (Applied voltage is the multiple of the rated voltage)

| Applied Voltage | Rated Voltage | Products |
|-----------------|---------------|---|
| ×1.0 | 10V | CM02X5R104 |
| ×1.3 | 6.3V | CM02X5R153-104, CT03X5R104 |
| ×1.5 | 16V | CM02X5R101-103, CM05X5R224, CM105X5R225, CM21X5R106, CM316X5R226, CM02X7R101-222, CM105X7R105, CM316X7R106, CM32X7R226, CT105X5R105, CT21X5R475 |
| | 25V | CM03X5R332-103, CM105X5R105, CM21X5R225-475, CM316X5R106, CM32X5R106-226, CM05X7R104, CM21X7R105-225, CM316X7R475, CM32X7R106 |
| | 50V | CM21X5R105, CM32X5R106, CM32X7R106, CT21X5R225, CM316X5R475 |

Please contact us for the optional specifications of the capacitance chart.



Test Conditions and Standards

Test Conditions and Specifications for High Dielectric Type (X5R, X6S, X7T) CM / CT Series (Standard Spec.2)

| Test Items | | Test Conditions | Specifications | | | | | | | | | | | | |
|----------------------------|---|--|--|-------------|------------|-------------|-------------|-------------|--------|--------------|-------------|--------------|-----------|-------------|----------------------------|
| Capacitance Value (C) | | Measure after heat treatment | Within tolerance | | | | | | | | | | | | |
| Tanδ | | <table border="1"> <thead> <tr> <th>Capacitance</th> <th>Frequency</th> <th>Volt</th> </tr> </thead> <tbody> <tr> <td>C≤10μF</td> <td>1kHz±10%</td> <td>1.0±0.2Vrms</td> </tr> <tr> <td>C>10μF</td> <td>1kHz±10%</td> <td>0.5±0.2Vrms</td> </tr> <tr> <td></td> <td>120Hz±10%</td> <td>0.5±0.2Vrms</td> </tr> </tbody> </table> <p>*CM02X5R474M06A#, CM03X5R225M06A#, CM03X5R225M06A#035, CM03X5R475M04A#, CT05X5R475M06A#033 The charge and discharge current of the capacitor must not exceed 50mA.</p> | Capacitance | Frequency | Volt | C≤10μF | 1kHz±10% | 1.0±0.2Vrms | C>10μF | 1kHz±10% | 0.5±0.2Vrms | | 120Hz±10% | 0.5±0.2Vrms | Refer to capacitance chart |
| | Capacitance | Frequency | Volt | | | | | | | | | | | | |
| C≤10μF | 1kHz±10% | 1.0±0.2Vrms | | | | | | | | | | | | | |
| C>10μF | 1kHz±10% | 0.5±0.2Vrms | | | | | | | | | | | | | |
| | 120Hz±10% | 0.5±0.2Vrms | | | | | | | | | | | | | |
| Insulation Resistance (IR) | | Apply the rated voltage for 1minute, and measure it in normal temperature and humidity. The charge and discharge current of the capacitor must not exceed 50mA. | Over 50MΩ•μF | | | | | | | | | | | | |
| Dielectric Resistance | | Apply 2.5 times of the rated voltage for 1 to 5 seconds. The charge and discharge current of the capacitor must not exceed 50mA. | No problem observed | | | | | | | | | | | | |
| Appearance | | Microscope | No problem observed | | | | | | | | | | | | |
| Termination Strength | | Apply a sideward force of 500g (5N) to a PCB-mounted sample. note : 2N for 0201 size, and 1N for 01005 size. Exclude CT series with thickness of less than 0.66mm. | No problem observed | | | | | | | | | | | | |
| Bending Strength | | Glass epoxy PCB: Fulcrum spacing: 90mm, duration time 10 seconds. Exclude CT series with thickness of less than 0.66mm. | No significant damage with 1mm bending | | | | | | | | | | | | |
| Vibration Test | Appearance | Take the initial value after heat treatment. Vibration frequency: 10 to 55 (Hz) Amplitude: 1.5mm | No problem observed | | | | | | | | | | | | |
| | ΔC | Sweeping condition: 10→55→10Hz/ 1 minute in X, Y and Z directions: 2 hours each, 6 hours in total, and place in normal temperature and humidity, then measure the sample after heat treatment. | Within tolerance | | | | | | | | | | | | |
| | Tanδ | | Within tolerance | | | | | | | | | | | | |
| Soldering Heat Resistant | Appearance | Take the initial value after heat treatment. Soak the sample in 260°C±5°C solder for 10±0.5 seconds and place in normal temperature and humidity, and measure after heat treatment. (Pre-heating conditions) | No problem observed | | | | | | | | | | | | |
| | ΔC | | Within±7.5% | | | | | | | | | | | | |
| | Tanδ | | Within tolerance | | | | | | | | | | | | |
| | IR | <table border="1"> <thead> <tr> <th>Order</th> <th>Temperature</th> <th>Time</th> </tr> </thead> <tbody> <tr> <td>1</td> <td>80 to 100°C</td> <td>2 minutes</td> </tr> <tr> <td>2</td> <td>150 to 200°C</td> <td>2 minutes</td> </tr> </tbody> </table> | Order | Temperature | Time | 1 | 80 to 100°C | 2 minutes | 2 | 150 to 200°C | 2 minutes | Over 50MΩ•μF | | | |
| | Order | Temperature | Time | | | | | | | | | | | | |
| 1 | 80 to 100°C | 2 minutes | | | | | | | | | | | | | |
| 2 | 150 to 200°C | 2 minutes | | | | | | | | | | | | | |
| Withstanding Voltage | The charge and discharge current of the capacitor must not exceed 50mA for IR and withstanding voltage measurement. | Resist without problem | | | | | | | | | | | | | |
| Solderability | | Soaking condition | Solder coverage : 95% min. | | | | | | | | | | | | |
| | | <table border="1"> <thead> <tr> <th>Sn-3Ag-0.5Cu</th> <th>245±5°C</th> <th>3±0.5 sec.</th> </tr> <tr> <th>Sn63 Solder</th> <th>235±5°C</th> <th>2±0.5 sec.</th> </tr> </thead> </table> | Sn-3Ag-0.5Cu | 245±5°C | 3±0.5 sec. | Sn63 Solder | 235±5°C | 2±0.5 sec. | | | | | | | |
| Sn-3Ag-0.5Cu | 245±5°C | 3±0.5 sec. | | | | | | | | | | | | | |
| Sn63 Solder | 235±5°C | 2±0.5 sec. | | | | | | | | | | | | | |
| Temperature Cycle | Appearance | Take the initial value after heat treatment. (Cycle) | No problem observed | | | | | | | | | | | | |
| | ΔC | Room temperature (3 min.)→Lowest operation temperature (30 min.)→Room temperature (3 min.)→Highest operation temperature(30 min.) | Within±7.5% | | | | | | | | | | | | |
| | Tanδ | After 5 cycles, measure after heat treatment. The charge and discharge current of the capacitor must not exceed 50mA for IR and withstanding voltage measurement. | Within tolerance | | | | | | | | | | | | |
| | IR | | Over 50MΩ•μF | | | | | | | | | | | | |
| | Withstanding Voltage | | Resist without problem | | | | | | | | | | | | |
| Moisture Resistant Load | Appearance | Take the initial value after heat treatment. After applying rated voltage for 500+12/-0 hours in the condition of 40°C±2°C and 90 to 95%RH, and place in normal temperature and humidity, then measure the sample after heat treatment. The charge and discharge current of the capacitor must not exceed 50mA for IR measurement. | No problem observed | | | | | | | | | | | | |
| | ΔC | | Within±12.5% | | | | | | | | | | | | |
| | Tanδ | | 200% max. of initial value | | | | | | | | | | | | |
| | IR | | Over 10MΩ•μF | | | | | | | | | | | | |
| High-Temperature Load | Appearance | Take the initial value after heat treatment. After applying □ times the rated voltage at the highest operation temperature for 1000+12/-0 hours, and measure the sample after heat treatment in normal temperature and humidity. The charge and discharge current of the capacitor must not exceed 50mA for IR measurement. | No problem observed | | | | | | | | | | | | |
| | ΔC | | Within±12.5% | | | | | | | | | | | | |
| | Tanδ | | 200% max. of initial value | | | | | | | | | | | | |
| | IR | * Apply 1.0 times when the rated voltage is 4V or less. Applied voltages for respective products are indicated in the chart below. | Over 10MΩ•μF | | | | | | | | | | | | |
| Heat treatment | | Expose sample in the temperature of 150+0/-10°C for 1 hour and leave the sample in normal temperature and humidity for 24±2 hours. | | | | | | | | | | | | | |

Voltage to be applied in the High Temperature Load (Applied voltage is the multiple of the rated voltage)

| Applied Voltage | Rated Voltage | Products | Applied Voltage | Rated Voltage | Products |
|-----------------|---------------|--|-----------------|---------------|--|
| ×1.0 | 6.3V | CM02X5R224, CM02X5R474, CM03X5R225, CM21X5R476 CT05X5R105, CT05X5R225, CT05X5R475 | ×1.3 | 6.3V | CM03X5R474 |
| | 10V | CM03X5R225, CM21X6S226 | | 10V | CM03X5R223-224, CM05X5R105-225 |
| | 16V | CM03X5R105, CM05X5R225 | | 16V | CM05X5R105 |
| | 25V | CM05X5R105, CM105X5R475, CM105X5R106 | ×1.5 | 6.3V | CM21X6S226, CM21X7T226 |
| | 35V | CM05X5R105, CM105X5R475, CM105X5R106 | | 10V | CM03X5R105, CM05X5R474, CM05X5R475 CM21X5R226 |
| ×1.2 | 6.3V | CM03X5R105 | | | |

Please contact us for the optional specifications of the capacitance chart.



Test Conditions and Standards

Substrate for Adhesion Strength Test, Vibration Test, Soldering Heat Resistance Test, Temperature Cycle Test, Load Humidity Test, High-Temperature with Loading Test.

(Unit: mm)

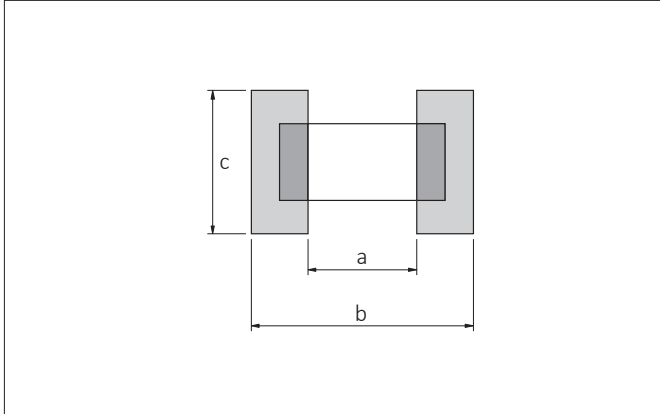

| Size (EIA Code) | a | b | c |
|-----------------|------|------|------|
| 02 (01005) | 0.15 | 0.50 | 0.20 |
| 03 (0201) | 0.26 | 0.92 | 0.32 |
| 05 (0402) | 0.4 | 1.4 | 0.5 |
| 105 (0603) | 1.0 | 3.0 | 1.2 |
| 21 (0805) | 1.2 | 4.0 | 1.65 |
| 316 (1206) | 2.2 | 5.0 | 2.0 |
| 32 (1210) | 2.2 | 5.0 | 2.9 |

Substrate for Bending Test

(Unit: mm)

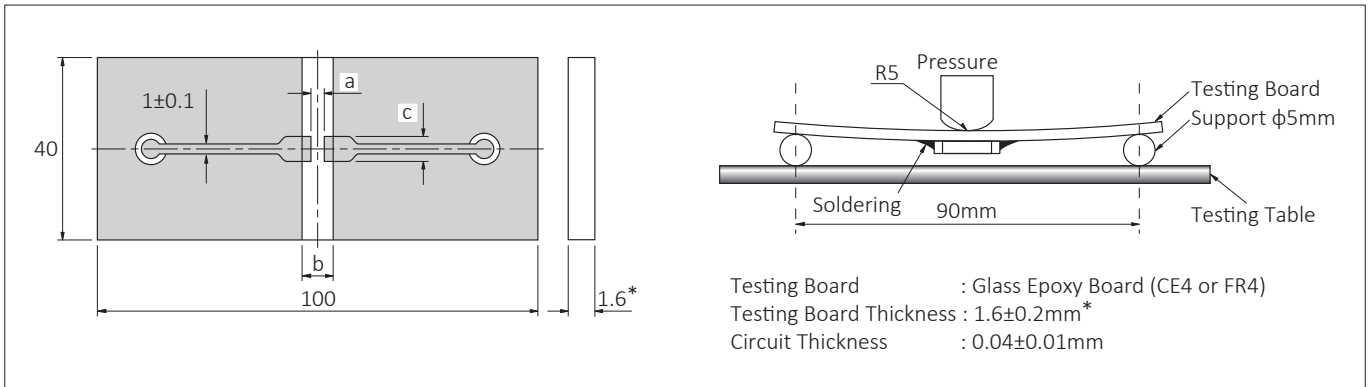

02, 03, 05 size 0.8±0.1mm

Structure

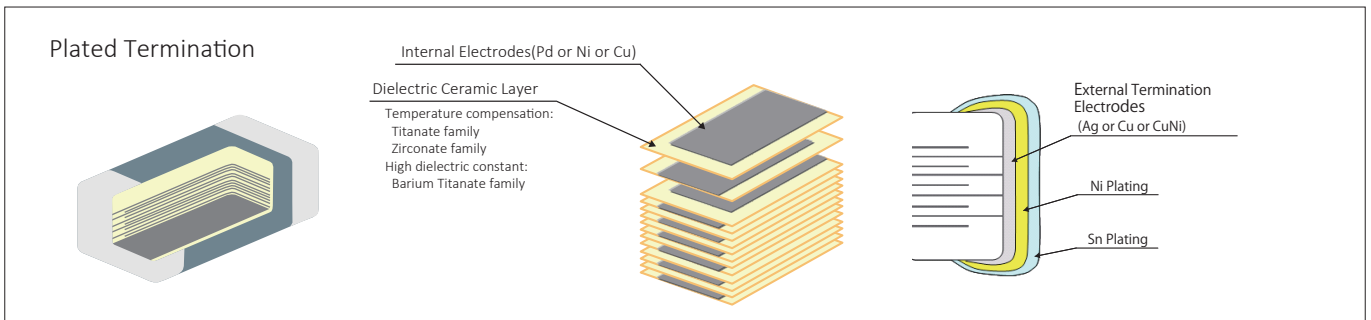

- Please contact your local kyocera sales office or distributor for specifications not covered in this catalog.
- Our products are continually being improved. As a result, the capacitance range of each series is subject to change without notice. Please contact sales representative to confirm compatibility with your application.



Packaging Options Tape and Reel

Reel

(Unit: mm)

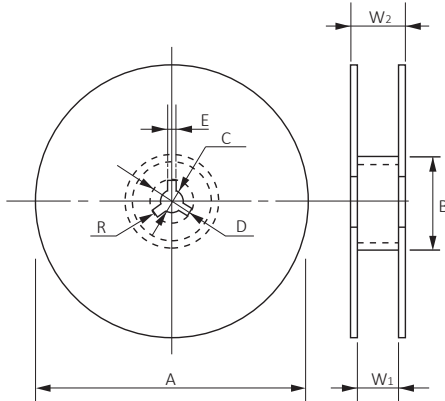

| Code Reel | A | B | C | D |
|------------------------------|-----------------------------------|----------------|----------------|--------|
| 7-inch Reel (CODE: T, H, Q) | 180 ⁺⁰ _{-2.0} | φ60 min. | 13±0.5 | 21±0.8 |
| 7-inch Reel (CODE: P) | 178±2.0 | | | |
| 13-inch Reel (CODE: L, N, W) | 330±2.0 | | | |
| Code Reel | E | W ₁ | W ₂ | R |
| 7-inch Reel (CODE: T, H, Q) | 2.0±0.5 | 10.5±1.5 | 16.5 max. | 1.0 |
| 7-inch Reel (CODE: P) | | 4.35±0.3 | 6.95±1.0 | |
| 13-inch Reel (CODE: L, N, W) | | 9.5±1.0 | 16.5 max. | |

Carrier Tape

F=1mm (02 Size)

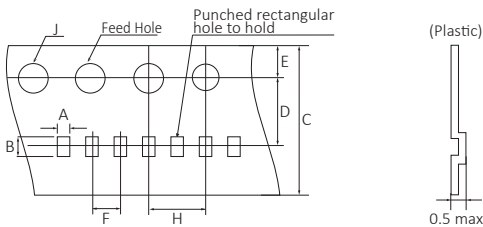

F=2mm (02, 03, 05 Size)

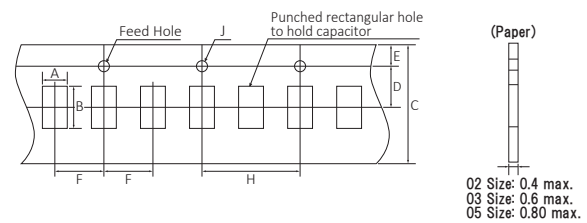

F=1mm (02, 03, 05 Size)

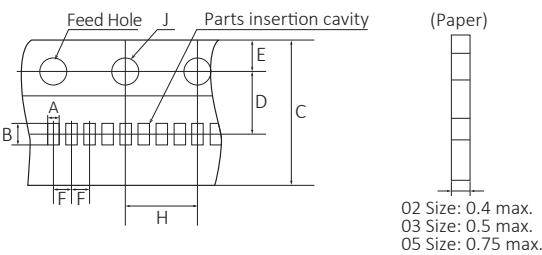

F=4mm (105, 21, 316, 32 Size)

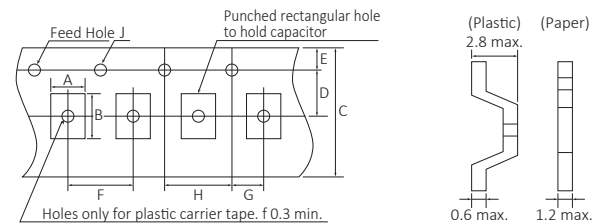

Carrier Tape

(Unit: mm)

| Size (EIA Code) | A | B | C | D | E | F | G | H | J | Carrier Tape | |
|-----------------|-----------|-----------|--------------|-----------|----------|----------|----------|----------|------------|--------------|----------|
| | | | | | | | | | | Width | Material |
| 02 (01005)* | 0.23±0.02 | 0.43±0.02 | 4.0±0.08 | 1.8±0.02 | 0.9±0.05 | 1.0±0.02 | — | 2.0±0.04 | 0.8±0.04 | 4mm | Plastic |
| | 0.25±0.03 | 0.45±0.03 | 8.0±0.3 | 3.5±0.05 | 1.75±0.1 | 2.0±0.05 | — | 4.0±0.1 | 1.5±0.1/-0 | 8mm | Paper |
| 03 (0201)* | 0.37±0.03 | 0.67±0.03 | 8.0+0.3/-0.1 | 3.5±0.05 | 1.75±0.1 | 1.0±0.05 | — | 4.0±0.05 | 1.5±0.1/-0 | 8mm | Paper |
| | 0.39±0.03 | 0.69±0.03 | 8.0±0.3 | | | 2.0±0.05 | 4.0±0.1 | | | | |
| | | | 0.42±0.03 | 0.72±0.03 | 8.0±0.3 | 3.5±0.05 | 1.75±0.1 | 2.0±0.05 | — | | |
| 05 (0402)* | 0.65±0.1 | 1.15±0.1 | 8.0+0.3/-0.1 | 3.5±0.05 | 1.75±0.1 | 1.0±0.05 | — | 4.0±0.05 | 1.5±0.1/-0 | 8mm | Paper |
| | 0.75±0.1 | | 8.0±0.3 | | | 2.0±0.05 | — | 4.0±0.1 | | | |
| | 0.8±0.1 | 1.3±0.1 | 8.0±0.3 | 3.5±0.05 | 1.75±0.1 | 2.0±0.05 | — | 4.0±0.1 | 1.5±0.1/-0 | | |
| 105 (0603)* | 1.0±0.2 | 1.8±0.2 | 8.0±0.3 | 3.5±0.05 | 1.75±0.1 | 4.0±0.1 | 2.0±0.05 | 4.0±0.1 | 1.5±0.1/-0 | 8mm | Paper |
| | 1.1±0.2 | 1.9±0.2 | 8.0±0.3 | 3.5±0.05 | 1.75±0.1 | 4.0±0.1 | 2.0±0.05 | 4.0±0.1 | 1.5±0.1/-0 | | |
| 21 (0805) | 1.5±0.2 | 2.3±0.2 | 8.0±0.3 | 3.5±0.05 | 1.75±0.1 | 4.0±0.1 | 2.0±0.05 | 4.0±0.1 | 1.5±0.1/-0 | 8mm | Paper |
| | | | | | | | | | | 8mm | Plastic |
| 316 (1206) | 2.0±0.2 | 3.6±0.2 | 8.0±0.3 | 3.5±0.05 | 1.75±0.1 | 4.0±0.1 | 2.0±0.05 | 4.0±0.1 | 1.5±0.1/-0 | 8mm | Paper |
| | | | | | | | | | | 8mm | Plastic |
| 32 (1210) | 2.9±0.2 | 3.6±0.2 | 8.0±0.3 | 3.5±0.05 | 1.75±0.1 | 4.0±0.1 | 2.0±0.05 | 4.0±0.1 | 1.5±0.1/-0 | 8mm | Plastic |

* Option



Packaging Options

Detail of leader and trailer

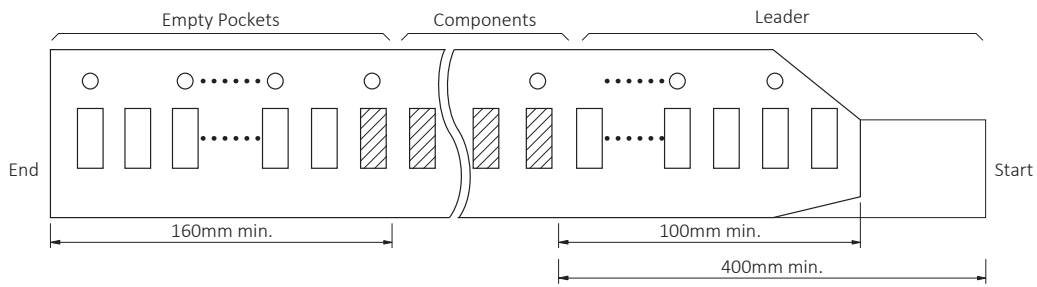

Adhesive tape

- 1) The exfoliative strength when peeling off the top tape from the carrier tape by the method of the following figure shall be ≥ 0.1 to $0.7N$. *02 Size: 0.1 to 0.5N
- 2) When the top tape is peeled off, the adhesive stays on the top tape.
- 3) Chip capacitors will be in a state free without being stuck on the thermal adhesive tape.

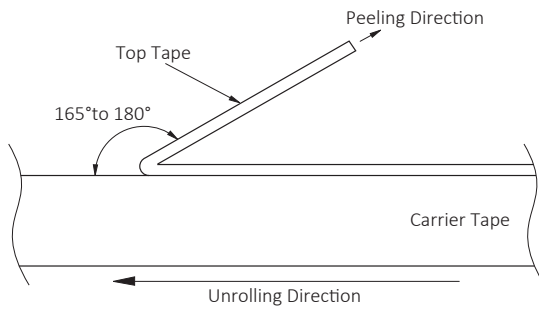

Exfoliating angle: 165 to 180 degrees to the carrier tape.
Exfoliating speed: 300 mm/min.

Carrier tape

- 1) Chip will not fall off from carrier tape or carrier tape will not be damaged by bending than within a radius of 25mm.
- 2) The chip are inserted continuously without any empty pocket.
- 3) Chip will not be mis-mounted because of too big clearance between components and cavity. Also the waste of carrier tape will not fill a nozzle hole of mounting machine.



Surface Mounting Information

Dimensions for recommended typical land

Since the amount of solder (size of fillet) to be used has direct influence on the capacitor after mounting, the sufficient consideration is necessary. When the amounts of solder is too much, the stress that a capacitor receives becomes larger. It may become the cause of a crack in the capacitor. When the land design of printed wiring board is considered, it is necessary to set up the form and size of land pattern so that the amount of solder is suitable.

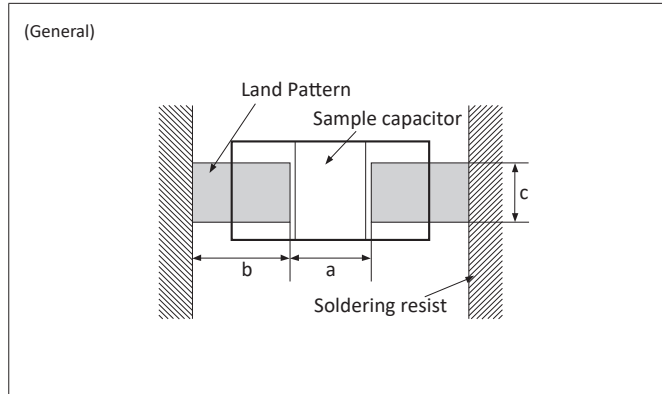

General

(Unit: mm)

| Size (EIA Code) | Dimension | | Recommended land dimensions | | |
|-----------------|-----------|-----------|-----------------------------|--------------|--------------|
| | L | W | a | b | c |
| 02 (01005) | 0.4±0.02 | 0.2±0.02 | 0.13 to 0.20 | 0.12 to 0.18 | 0.20 to 0.23 |
| | 0.6±0.03 | 0.3±0.03 | 0.20 to 0.25 | 0.25 to 0.35 | 0.30 to 0.40 |
| 03 (0201) | 0.6±0.05 | 0.3±0.05 | 0.23 to 0.30 | 0.25 to 0.35 | 0.30 to 0.45 |
| | 0.6±0.09 | 0.3±0.09 | 0.23 to 0.30 | 0.25 to 0.35 | 0.30 to 0.45 |
| 05 (0402) | 1.0±0.05 | 0.5±0.05 | 0.30 to 0.50 | 0.35 to 0.45 | 0.40 to 0.60 |
| | 1.0±0.15 | 0.5±0.15 | 0.40 to 0.60 | 0.40 to 0.50 | 0.50 to 0.75 |
| 105 (0603) | 1.6±0.10 | 0.8±0.10 | 0.70 to 1.00 | 0.80 to 1.00 | 0.60 to 0.90 |
| | 1.6±0.15 | 0.8±0.15 | 0.80 to 1.00 | 0.80 to 1.00 | 0.80 to 1.10 |
| 21 (0805) | 1.6±0.20 | 0.8±0.20 | 0.80 to 1.00 | 0.80 to 1.00 | 0.80 to 1.10 |
| | 1.6±0.25 | 0.8±0.25 | 0.80 to 1.00 | 0.80 to 1.00 | 0.80 to 1.10 |
| 316 (1206) | 2.0±0.10 | 1.25±0.10 | 1.00 to 1.30 | 1.00 to 1.20 | 1.00 to 1.45 |
| | 2.0±0.15 | 1.25±0.15 | 1.00 to 1.30 | 1.00 to 1.20 | 1.25 to 1.55 |
| 32 (1210) | 2.0±0.20 | 1.25±0.20 | 1.00 to 1.30 | 1.00 to 1.20 | 1.25 to 1.55 |
| | 2.0±0.20 | 1.25±0.20 | 1.00 to 1.30 | 1.00 to 1.20 | 1.25 to 1.55 |
| 316 (1206) | 3.2±0.20 | 1.6±0.15 | 2.10 to 2.50 | 1.10 to 1.30 | 1.40 to 1.90 |
| | 3.2±0.20 | 1.6±0.20 | 2.10 to 2.50 | 1.10 to 1.30 | 1.60 to 2.00 |
| 32 (1210) | 3.2±0.30 | 1.6±0.30 | 2.10 to 2.50 | 1.10 to 1.30 | 1.60 to 2.00 |
| | 3.2±0.30 | 1.6±0.30 | 2.10 to 2.50 | 1.10 to 1.30 | 1.60 to 2.00 |
| 32 (1210) | 3.2±0.30 | 2.5±0.20 | 2.10 to 2.50 | 1.10 to 1.30 | 1.90 to 2.80 |

* Recommended land dimensions may differ depending on dimensional tolerance.

Design of printed circuit and Soldering

The recommended fillet height shall be 1/2 of the thickness of capacitors or 0.5mm. When mounting two or more capacitors in the common land, it is necessary to separate the land with the solder resist so that it may become the exclusive land of each capacitor.

Ideal Solder Height

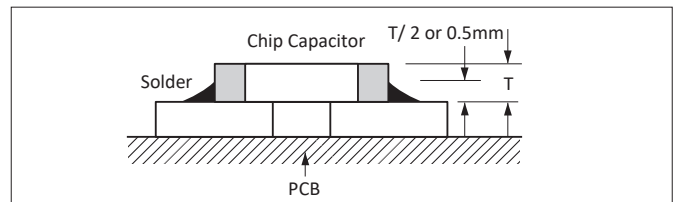

| Item | Prohibited | Recommended example : Separation by solder resist |
|-------------------------------|------------|---|
| Multiple parts mount | | |
| Mount with leaded parts | | |
| Wire soldering after mounting | | |
| Side by side layout | | |



Surface Mounting Information

Mounting Design

The chip could crack if the PCB warps during processing after the chip has been soldered.

Recommended chip position on PCB to minimize stress from PCB warpage



Actual Mounting

- 1) If the position of the vacuum nozzle is too low, a large force may be applied to the chip capacitor during mounting, resulting in cracking.
- 2) During mounting, set the nozzle pressure to a static load of 1 to 3 N.
- 3) To minimize the shock of the vacuum nozzle, provide a support pin on the back of the PCB to minimize PCB flexure.

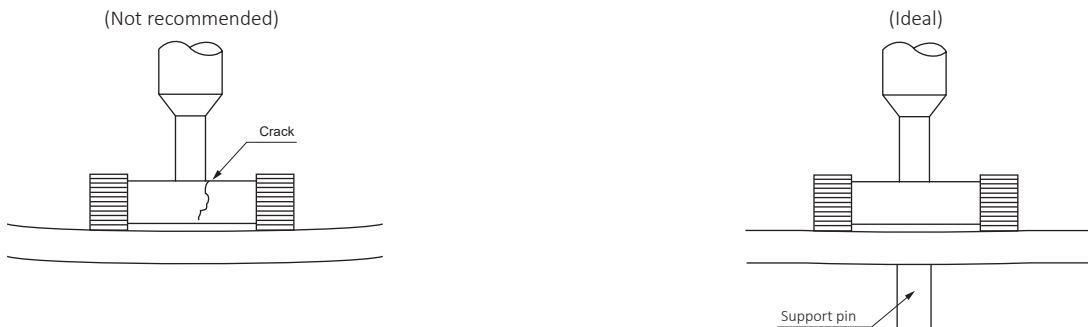

- 4) Bottom position of pick up nozzle should be adjusted to the top surface of a substrate which camber is corrected.

Resin Mold

- 1) If a large amount of resin is used for molding the chip, cracks may occur due to contraction stress during curing. To avoid such cracks, use a low shrinkage resin.
- 2) The insulation resistance of the chip will degrade due to moisture absorption. Use a low moisture absorption resin.
- 3) Check carefully that the resin does not generate a decomposition gas or reaction gas during the curing process or during normal storage. Such gases may crack the chip capacitor or damage the device itself.



Surface Mounting Information

Soldering Method

- 1) Ceramic is easily damaged by rapid heating or cooling. If some heat shock is unavoidable, preheat enough to limit the temperature difference (ΔT) to within 150 degree Celsius.
- 2) The product size 1.6×0.8mm to 3.2×1.6mm can be used in reflow and wave soldering, and the product size of bigger than 3.2×1.6mm, or smaller than 1.6×0.8mm can be used in reflow.
Circuit shortage and smoking can be created by using capacitors which are used neglecting the above caution.
- 3) Please see our recommended soldering conditions.
- 4) In case of using Sn-Zn Solder, please contact us in advance.
- 5) The following condition is recommended for spot heater application.

Recommended spot heater condition

| Item | Condition |
|------------------|---|
| Distance | 5mm min. |
| Angle | 45° |
| Projection Temp. | 400°C max. |
| Flow rate | Set at the minimum |
| Nozzle diameter | 2φ to 4φ (Single hole type) |
| Application time | 10 sec. max. (1206 and smaller) 30 sec. max. (1210 and larger) |

How to point spot heater

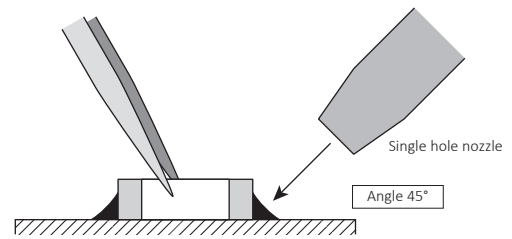

Recommended Temperature Profile (Sn-3Ag-0.5Cu)

Reflow

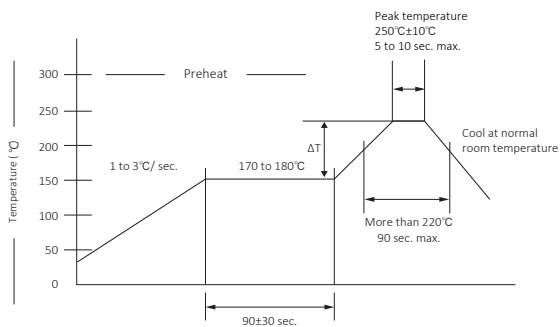

- ① Minimize soldering time.
- ② Ensure that allowable temperature difference does not exceed 150°C.
- ③ Ensure that allowable temperature difference does not exceed 130°C for 3.2x2.5mm size or larger.
- ④ MLCC can withstand the above reflow conditions up to 3 times.
- ⑤ N₂ atmosphere is recommended for reflow of products of 0.4mmx0.2mm size or smaller.

Wave

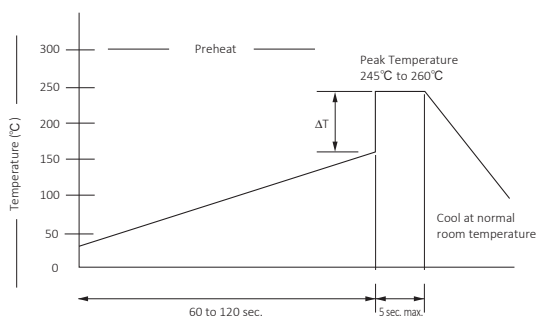

- ① Ensure that the chip capacitor is preheated adequately.
- ② Ensure that the temperature difference (ΔT) does not exceed 150°C.
- ③ Cool naturally after soldering.
- ④ Wave soldering is not applicable for chips with size of 3.2x2.5mm or larger of 1.0x0.5mm or smaller and capacitor arrays.

Recommended Temperature Profile (63Sn Solder)

Reflow

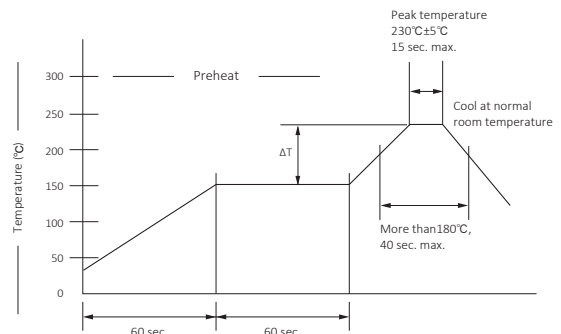

- ① Minimize soldering time.
- ② Ensure that the temperature difference (ΔT) does not exceed 150°C.
- ③ Ensure that the temperature difference (ΔT) does not exceed 130°C for 3.2x2.5mm size or larger.
- ④ MLCC can withstand the above reflow conditions up to 3 times.

Wave

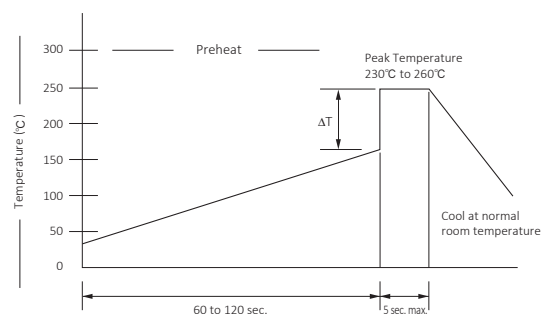

- ① Ensure that the chip capacitor is preheated adequately.
- ② Ensure that the temperature difference (ΔT) does not exceed 150°C.
- ③ Cool naturally after soldering.
- ④ Wave soldering is not applicable for chips with size of 3.2x2.5mm or larger of 1.0x0.5mm or smaller and capacitor arrays.



Precautions

Circuit Design

1. Once application and assembly environments have been checked, the capacitor may be used in conformance with the rating and performance which are provided in both the catalog and the specifications. Use exceeding that which is specified may result in inferior performance or cause a short, open, smoking, or flaming to occur, etc.
2. Please consult the manufacturer in advance when the capacitor is used in devices such as: devices which deal with human life, i.e. medical devices; devices which are highly public orientated; and devices which demand a high standard of liability.
Accident or malfunction of devices such as medical devices, space equipment and devices having to do with atomic power could generate grave consequence with respect to human lives or, possibly, a portion of the public. Capacitors used in these devices may require high reliability design different from that of general purpose capacitors.
3. Please use the capacitors in conformance with the operating temperature provided in both the catalog and the specifications.
Be especially cautious not to exceed the maximum temperature. In the situation the maximum temperature set forth in both the catalog and specifications is exceeded, the capacitor's insulation resistance may deteriorate, power may suddenly surge and short-circuit may occur.
The capacitor has a loss, and may self-heat due to equivalent series resistance when alternating electric current is passed therethrough. As this effect becomes especially pronounced in high frequency circuits, please exercise caution.
When using the capacitor in a (self-heating) circuit, please make sure the surface of the capacitor remains under the maximum temperature for usage. Also, please make certain temperature rises remain below 20°C.
4. Please keep voltage under the rated voltage which is applied to the capacitor. Also, please make certain the peak voltage remains below the rated voltage when AC voltage is super-imposed to the DC voltage.
In the situation where AC or pulse voltage is employed, ensure average peak voltage does not exceed the rated voltage.
Exceeding the rated voltage provided in both catalog and specifications may lead to defective withstanding voltage or, in worst case situations, may cause the capacitor to smoke or flame.
5. When the capacitor is to be employed in a circuit in which there is continuous application of a high frequency voltage or a steep pulse voltage, even though it is within the rated voltage, please inquire to the manufacturer.
In the situation the capacitor is to be employed using a high frequency AC voltage or a extremely fast rising pulse voltage, even though it is within the rated voltage, it is possible capacitor reliability will deteriorate.
6. It is a common phenomenon of high-dielectric products to have a deteriorated amount of static electricity due to the application of DC voltage.
Due caution is necessary as the degree of deterioration varies depending on the quality of capacitor materials, capacity, as well as the load voltage at the time of operation.
7. Do not use the capacitor in an environment where it might easily exceed the respective provisions concerning shock and vibration specified in the catalog and specifications.
In addition, it is a common piezo phenomenon of high dielectric products to have some voltage due to vibration or to have noise due to voltage change. Please contact sales in such case.
8. If the electrostatic capacity value of the delivered capacitor is within the specified tolerance, please consider this when designing the respective product in order that the assembled product function appropriately.
9. Please contact us upon using conductive adhesives.

Storage

1. If the component is stored in minimal packaging (a heat-sealed or zippered plastic bag), the bag should be kept closed. Once the bag has been opened, reseal it or store it in a desiccator.
2. Keep storage place temperature + 5 to + 40 °C, humidity 20 to 70% RH. See JIS C 60721-3-1, class 1K2 for other climatic conditions.
3. The storage atmosphere must be free of corrosive gas such as sulfur dioxide and chlorine. Also, avoid exposing the product to saline moisture. If the product is exposed to such atmospheres, the terminals will oxidize and solderability will be effected.
4. Precautions 1) to 3) apply to chip capacitors packaged in carrier tapes.
5. The solderability is assured for 6 months from our shipping date if the above storage precautions are followed.

Safety application guideline and detailed information of electrical properties are also provided in kyocera web site;

URL: <https://global.kyocera.com/prdct/electro/>



Part Number List



General CM02 Series Size (JIS Code) : 01005(0402) # Packaging Code (Packaging quantity) : H(20,000pcs.) / N(80,000pcs.) / P(40,000pcs.)

| Dielectric code CA | Capacitance | □:Tolerance | Voltage [V] | Part Number | Q | Dimension | | | # Packaging Code (quantity) |
|-----------------------|----------------|----------------------|----------------|----------------|----------|-----------|----------|-----------|--------------------------------|
| | | | | | | L[mm] | W[mm] | T[mm] | |
| CG/CH | 1.0pF | B:±0.1pF / C:±0.25pF | 25 | CM02CA1R0□25A# | 420 | 0.4±0.02 | 0.2±0.02 | 0.2±0.02 | H / N / P |
| | 1.5pF | | | CM02CA1R5□25A# | 430 | 0.4±0.02 | 0.2±0.02 | 0.2±0.02 | H / N / P |
| | 2.0pF | | | CM02CA2R0□25A# | 440 | 0.4±0.02 | 0.2±0.02 | 0.2±0.02 | H / N / P |
| | 3.0pF | | | CM02CA3R0□25A# | 460 | 0.4±0.02 | 0.2±0.02 | 0.2±0.02 | H / N / P |
| | 4.0pF | | | CM02CA4R0□25A# | 480 | 0.4±0.02 | 0.2±0.02 | 0.2±0.02 | H / N / P |
| | 5.0pF | | | CM02CA5R0□25A# | 500 | 0.4±0.02 | 0.2±0.02 | 0.2±0.02 | H / N / P |
| | 6.0pF | C:±0.25pF / D:±0.5pF | 25 | CM02CA6R0□25A# | 520 | 0.4±0.02 | 0.2±0.02 | 0.2±0.02 | H / N / P |
| | 7.0pF | | | CM02CA7R0□25A# | 540 | 0.4±0.02 | 0.2±0.02 | 0.2±0.02 | H / N / P |
| | 8.0pF | | | CM02CA8R0□25A# | 560 | 0.4±0.02 | 0.2±0.02 | 0.2±0.02 | H / N / P |
| | 9.0pF | | | CM02CA9R0□25A# | 580 | 0.4±0.02 | 0.2±0.02 | 0.2±0.02 | H / N / P |
| | 10pF | | | CM02CA100□25A# | 600 | 0.4±0.02 | 0.2±0.02 | 0.2±0.02 | H / N / P |
| | 12pF | | | CM02CA120□25A# | 640 | 0.4±0.02 | 0.2±0.02 | 0.2±0.02 | H / N / P |
| | 15pF | J:±5% / K:±10% | 25 | CM02CA150□25A# | 700 | 0.4±0.02 | 0.2±0.02 | 0.2±0.02 | H / N / P |
| | 18pF | | | CM02CA180□25A# | 760 | 0.4±0.02 | 0.2±0.02 | 0.2±0.02 | H / N / P |
| | 22pF | | | CM02CA220□25A# | 840 | 0.4±0.02 | 0.2±0.02 | 0.2±0.02 | H / N / P |
| | 27pF | | | CM02CA270□16A# | 940 | 0.4±0.02 | 0.2±0.02 | 0.2±0.02 | H / N / P |
| | 33pF | | | CM02CA330□16A# | 1000 | 0.4±0.02 | 0.2±0.02 | 0.2±0.02 | H / N / P |
| | 39pF | | | CM02CA390□16A# | 1000 | 0.4±0.02 | 0.2±0.02 | 0.2±0.02 | H / N / P |
| | 47pF | J:±5% / K:±10% | 16 | CM02CA470□16A# | 1000 | 0.4±0.02 | 0.2±0.02 | 0.2±0.02 | H / N / P |
| | 56pF | | | CM02CA560□16A# | 1000 | 0.4±0.02 | 0.2±0.02 | 0.2±0.02 | H / N / P |
| | 68pF | | | CM02CA680□16A# | 1000 | 0.4±0.02 | 0.2±0.02 | 0.2±0.02 | H / N / P |
| | 82pF | | | CM02CA820□16A# | 1000 | 0.4±0.02 | 0.2±0.02 | 0.2±0.02 | H / N / P |
| 100pF | CM02CA101□16A# | | | 1000 | 0.4±0.02 | 0.2±0.02 | 0.2±0.02 | H / N / P | |
| 220pF | CM02CA221□16A# | | | 1000 | 0.4±0.02 | 0.2±0.02 | 0.2±0.02 | H / N / P | |

General CM03 Series Size (JIS Code) : 0201(0603) # Packaging Code (Packaging quantity) : H(15,000pcs.) / N(50,000pcs.) / Q(30,000pcs.) / W(150,000pcs.)

| Dielectric code CA | Capacitance | □:Tolerance | Voltage [V] | Part Number | Q | Dimension | | | # Packaging Code (quantity) |
|-----------------------|----------------|----------------------|----------------|----------------|----------|-----------|----------|---------------|--------------------------------|
| | | | | | | L[mm] | W[mm] | T[mm] | |
| CG/CH | 1.0pF | B:±0.1pF / C:±0.25pF | 50 | CM03CA1R0□50A# | 420 | 0.6±0.03 | 0.3±0.03 | 0.3±0.03 | H / N / Q / W |
| | 1.5pF | | | CM03CA1R5□50A# | 430 | 0.6±0.03 | 0.3±0.03 | 0.3±0.03 | H / N / Q / W |
| | 2.0pF | | | CM03CA2R0□50A# | 440 | 0.6±0.03 | 0.3±0.03 | 0.3±0.03 | H / N / Q / W |
| | 3.0pF | | | CM03CA3R0□50A# | 460 | 0.6±0.03 | 0.3±0.03 | 0.3±0.03 | H / N / Q / W |
| | 4.0pF | | | CM03CA4R0□50A# | 480 | 0.6±0.03 | 0.3±0.03 | 0.3±0.03 | H / N / Q / W |
| | 5.0pF | | | CM03CA5R0□50A# | 500 | 0.6±0.03 | 0.3±0.03 | 0.3±0.03 | H / N / Q / W |
| | 6.0pF | C:±0.25pF / D:±0.5pF | 50 | CM03CA6R0□50A# | 520 | 0.6±0.03 | 0.3±0.03 | 0.3±0.03 | H / N / Q / W |
| | 7.0pF | | | CM03CA7R0□50A# | 540 | 0.6±0.03 | 0.3±0.03 | 0.3±0.03 | H / N / Q / W |
| | 8.0pF | | | CM03CA8R0□50A# | 560 | 0.6±0.03 | 0.3±0.03 | 0.3±0.03 | H / N / Q / W |
| | 9.0pF | | | CM03CA9R0□50A# | 580 | 0.6±0.03 | 0.3±0.03 | 0.3±0.03 | H / N / Q / W |
| | 10pF | | | CM03CA100□50A# | 600 | 0.6±0.03 | 0.3±0.03 | 0.3±0.03 | H / N / Q / W |
| | 12pF | | | CM03CA120□50A# | 640 | 0.6±0.03 | 0.3±0.03 | 0.3±0.03 | H / N / Q / W |
| | 15pF | J:±5% / K:±10% | 50 | CM03CA150□50A# | 700 | 0.6±0.03 | 0.3±0.03 | 0.3±0.03 | H / N / Q / W |
| | 18pF | | | CM03CA180□50A# | 760 | 0.6±0.03 | 0.3±0.03 | 0.3±0.03 | H / N / Q / W |
| | 22pF | | | CM03CA220□50A# | 840 | 0.6±0.03 | 0.3±0.03 | 0.3±0.03 | H / N / Q / W |
| | 27pF | | | CM03CA270□50A# | 940 | 0.6±0.03 | 0.3±0.03 | 0.3±0.03 | H / N / Q / W |
| | 33pF | | | CM03CA330□50A# | 1000 | 0.6±0.03 | 0.3±0.03 | 0.3±0.03 | H / N / Q / W |
| | 39pF | | | CM03CA390□50A# | 1000 | 0.6±0.03 | 0.3±0.03 | 0.3±0.03 | H / N / Q / W |
| | 47pF | J:±5% / K:±10% | 50 | CM03CA470□50A# | 1000 | 0.6±0.03 | 0.3±0.03 | 0.3±0.03 | H / N / Q / W |
| | 56pF | | | CM03CA560□50A# | 1000 | 0.6±0.03 | 0.3±0.03 | 0.3±0.03 | H / N / Q / W |
| | 68pF | | | CM03CA680□50A# | 1000 | 0.6±0.03 | 0.3±0.03 | 0.3±0.03 | H / N / Q / W |
| | 82pF | | | CM03CA820□50A# | 1000 | 0.6±0.03 | 0.3±0.03 | 0.3±0.03 | H / N / Q / W |
| 100pF | CM03CA101□50A# | | | 1000 | 0.6±0.03 | 0.3±0.03 | 0.3±0.03 | H / N / Q / W | |



Part Number List



General CM02 Series Size (JIS Code) : 01005(0402) # Packaging Code (Packaging quantity) : H(20,000pcs.) / N(80,000pcs.) / P(40,000pcs.)

| Dielectric code | Capacitance | □:Tolerance | Voltage [V] | Part Number | Tanδ [%] | Dimension | | | # Packaging Code (quantity) |
|-----------------|-------------|-----------------|-----------------|-----------------|----------|-----------|-----------|-----------|-----------------------------|
| | | | | | | L[mm] | W[mm] | T[mm] | |
| X5R | 100pF | K:±10% / M:±20% | 16 | CM02X5R101□16A# | 12.5 | 0.4±0.02 | 0.2±0.02 | 0.2±0.02 | H / N / P |
| | 150pF | | | CM02X5R151□16A# | 12.5 | 0.4±0.02 | 0.2±0.02 | 0.2±0.02 | H / N / P |
| | 220pF | | | CM02X5R221□16A# | 12.5 | 0.4±0.02 | 0.2±0.02 | 0.2±0.02 | H / N / P |
| | 330pF | | | CM02X5R331□16A# | 12.5 | 0.4±0.02 | 0.2±0.02 | 0.2±0.02 | H / N / P |
| | 470pF | | | CM02X5R471□16A# | 12.5 | 0.4±0.02 | 0.2±0.02 | 0.2±0.02 | H / N / P |
| | 680pF | | | CM02X5R681□16A# | 12.5 | 0.4±0.02 | 0.2±0.02 | 0.2±0.02 | H / N / P |
| | 1000pF | | | CM02X5R102□16A# | 12.5 | 0.4±0.02 | 0.2±0.02 | 0.2±0.02 | H / N / P |
| | 1500pF | | | CM02X5R152□16A# | 12.5 | 0.4±0.02 | 0.2±0.02 | 0.2±0.02 | H / N / P |
| | 2200pF | | | CM02X5R222□16A# | 12.5 | 0.4±0.02 | 0.2±0.02 | 0.2±0.02 | H / N / P |
| | 3300pF | | | CM02X5R332□16A# | 12.5 | 0.4±0.02 | 0.2±0.02 | 0.2±0.02 | H / N / P |
| | 4700pF | CM02X5R472□16A# | 12.5 | 0.4±0.02 | 0.2±0.02 | 0.2±0.02 | H / N / P | | |
| | 6800pF | CM02X5R682□16A# | 12.5 | 0.4±0.02 | 0.2±0.02 | 0.2±0.02 | H / N / P | | |
| | 10000pF | CM02X5R103□16A# | 12.5 | 0.4±0.02 | 0.2±0.02 | 0.2±0.02 | H / N / P | | |
| | 15000pF | CM02X5R153□06A# | 12.5 | 0.4±0.02 | 0.2±0.02 | 0.2±0.02 | H / N / P | | |
| | 22000pF | CM02X5R223□06A# | 12.5 | 0.4±0.02 | 0.2±0.02 | 0.2±0.02 | H / N / P | | |
| | 33000pF | CM02X5R333□06A# | 12.5 | 0.4±0.02 | 0.2±0.02 | 0.2±0.02 | H / N / P | | |
| | 47000pF | CM02X5R473□06A# | 12.5 | 0.4±0.02 | 0.2±0.02 | 0.2±0.02 | H / N / P | | |
| | 68000pF | CM02X5R683□06A# | 12.5 | 0.4±0.02 | 0.2±0.02 | 0.2±0.02 | H / N / P | | |
| | 0.10μF | K:±10% / M:±20% | 10 | CM02X5R104□10A# | 12.5 | 0.4±0.02 | 0.2±0.02 | 0.2±0.02 | H / N / P |
| | 0.22μF | M:±20% | 6.3 | CM02X5R104□06A# | 12.5 | 0.4±0.02 | 0.2±0.02 | 0.2±0.02 | H / N / P |
| 0.47μF | 6.3 | | CM02X5R224M06A# | 12.5 | 0.4±0.02 | 0.2±0.02 | 0.2±0.02 | H / N / P | |
| X7R | 100pF | K:±10% / M:±20% | 16 | CM02X7R101□16A# | 12.5 | 0.4±0.02 | 0.2±0.02 | 0.2±0.02 | H / N / P |
| | 150pF | | | CM02X7R151□16A# | 12.5 | 0.4±0.02 | 0.2±0.02 | 0.2±0.02 | H / N / P |
| | 220pF | | | CM02X7R221□16A# | 12.5 | 0.4±0.02 | 0.2±0.02 | 0.2±0.02 | H / N / P |
| | 330pF | | | CM02X7R331□16A# | 12.5 | 0.4±0.02 | 0.2±0.02 | 0.2±0.02 | H / N / P |
| | 470pF | | | CM02X7R471□16A# | 12.5 | 0.4±0.02 | 0.2±0.02 | 0.2±0.02 | H / N / P |
| | 680pF | | | CM02X7R681□16A# | 12.5 | 0.4±0.02 | 0.2±0.02 | 0.2±0.02 | H / N / P |
| | 1000pF | | | CM02X7R102□16A# | 12.5 | 0.4±0.02 | 0.2±0.02 | 0.2±0.02 | H / N / P |
| | 1500pF | | | CM02X7R152□16A# | 12.5 | 0.4±0.02 | 0.2±0.02 | 0.2±0.02 | H / N / P |
| | 2200pF | | | CM02X7R222□16A# | 12.5 | 0.4±0.02 | 0.2±0.02 | 0.2±0.02 | H / N / P |

General CM03 Series Size (JIS Code) : 0201(0603) # Packaging Code (Packaging quantity) : H(15,000pcs.)(*10,000pcs.) / N(50,000pcs.) / Q(30,000pcs.) / W(150,000pcs.)

| Dielectric code | Capacitance | □:Tolerance | Voltage [V] | Part Number | Tanδ [%] | Dimension | | | # Packaging Code (quantity) |
|--------------------|-------------|-----------------|--------------------|--------------------|----------|-----------|----------|---------------|-----------------------------|
| | | | | | | L[mm] | W[mm] | T[mm] | |
| X5R | 3300pF | K:±10% / M:±20% | 25 | CM03X5R332□25A# | 5.0 | 0.6±0.03 | 0.3±0.03 | 0.3±0.03 | H / N / Q / W |
| | 4700pF | | | CM03X5R472□25A# | 5.0 | 0.6±0.03 | 0.3±0.03 | 0.3±0.03 | H / N / Q / W |
| | 6800pF | | | CM03X5R682□25A# | 5.0 | 0.6±0.03 | 0.3±0.03 | 0.3±0.03 | H / N / Q / W |
| | 10000pF | | | CM03X5R103□25A# | 5.0 | 0.6±0.03 | 0.3±0.03 | 0.3±0.03 | H / N / Q / W |
| | 22000pF | K:±10% / M:±20% | 10 | CM03X5R223□10A# | 10.0 | 0.6±0.03 | 0.3±0.03 | 0.3±0.03 | H / N / Q / W |
| | 33000pF | | | CM03X5R333□10A# | 10.0 | 0.6±0.03 | 0.3±0.03 | 0.3±0.03 | H / N / Q / W |
| | 47000pF | | | CM03X5R473□10A# | 10.0 | 0.6±0.03 | 0.3±0.03 | 0.3±0.03 | H / N / Q / W |
| | 68000pF | | | CM03X5R683□10A# | 10.0 | 0.6±0.03 | 0.3±0.03 | 0.3±0.03 | H / N / Q / W |
| | 0.10μF | | | CM03X5R104□10A# | 10.0 | 0.6±0.03 | 0.3±0.03 | 0.3±0.03 | H / N / Q / W |
| | 0.22μF | | | CM03X5R224□10A# | 10.0 | 0.6±0.03 | 0.3±0.03 | 0.3±0.03 | H / N / Q / W |
| | 0.47μF | K:±10% / M:±20% | 6.3 | CM03X5R474□06A# | 12.5 | 0.6±0.03 | 0.3±0.03 | 0.3±0.03 | H / N / Q / W |
| | 1.0μF | M:±20% | 16 | CM03X5R105M16AH | 20.0 | 0.6±0.09 | 0.3±0.09 | 0.3±0.09 | H |
| | | | 10 | CM03X5R105M10AH | 20.0 | 0.6±0.09 | 0.3±0.09 | 0.3±0.09 | H |
| | | | 6.3 | CM03X5R105M06AH | 12.5 | 0.6±0.05 | 0.3±0.05 | 0.3±0.05 | H / N / Q / W |
| | | | 10 | CM03X5R225M10AH | 15.0 | 0.6±0.09 | 0.3±0.09 | 0.3±0.09 | H |
| | 2.2μF | M:±20% | 6.3 | CM03X5R225M06AH | 12.5 | 0.6±0.09 | 0.3±0.09 | 0.3±0.09 | H |
| CM03X5R225M06A#035 | | | | 12.5 | 0.6±0.05 | 0.3±0.05 | 0.3±0.05 | H / N / Q / W | |
| 4.7μF | M:±20% | 6.3 | CM03X5R475M06AH055 | 15.0 | 0.6±0.09 | 0.3±0.09 | 0.5±0.05 | H(*) | |
| | | | CM03X5R475M04AH | 12.5 | 0.6±0.09 | 0.3±0.09 | 0.3±0.09 | H | |
| X6S | 1.0μF | M:±20% | 6.3 | CM03X6S105M06AH039 | 20.0 | 0.6±0.09 | 0.3±0.09 | 0.3±0.09 | H |
| | | | | CM03X6S105M04AH039 | 20.0 | 0.6±0.09 | 0.3±0.09 | 0.3±0.09 | H |
| X7R | 3300pF | K:±10% / M:±20% | 10 | CM03X7R332□10A# | 5.0 | 0.6±0.03 | 0.3±0.03 | 0.3±0.03 | H / N / Q / W |
| | | | | CM03X7R472□10A# | 5.0 | 0.6±0.03 | 0.3±0.03 | 0.3±0.03 | H / N / Q / W |
| | | | | CM03X7R682□10A# | 5.0 | 0.6±0.03 | 0.3±0.03 | 0.3±0.03 | H / N / Q / W |
| | | | | CM03X7R103□10A# | 5.0 | 0.6±0.03 | 0.3±0.03 | 0.3±0.03 | H / N / Q / W |

General CM05 Series Size (JIS Code) : 0402(1005) # Packaging Code (Packaging quantity) : H(10,000pcs.) / N(50,000pcs.)(*40,000pcs.) / Q(20,000pcs.) / W(100,000pcs.)

| Dielectric code | Capacitance | □:Tolerance | Voltage [V] | Part Number | Tanδ [%] | Dimension | | | # Packaging Code (quantity) | |
|-----------------|-------------|-----------------|-------------|--------------------|--------------------|-----------|----------|-----------|-----------------------------|---------------|
| | | | | | | L[mm] | W[mm] | T[mm] | | |
| X5R | 0.10μF | K:±10% / M:±20% | 25 | CM05X5R104□25A# | 5.0 | 1.0±0.05 | 0.5±0.05 | 0.5±0.05 | H / N / Q / W | |
| | 0.22μF | | | CM05X5R224□16A# | 12.5 | 1.0±0.05 | 0.5±0.05 | 0.5±0.05 | H / N / Q / W | |
| | 0.47μF | | | CM05X5R474□10A# | 12.5 | 1.0±0.05 | 0.5±0.05 | 0.5±0.05 | H / N / Q / W | |
| | 1.0μF | K:±10% / M:±20% | 35 | 10 | CM05X5R105□35A# | 10.0 | 1.0±0.05 | 0.5±0.05 | 0.5±0.05 | H / N / Q / W |
| | | | | | CM05X5R105□25A# | 10.0 | 1.0±0.05 | 0.5±0.05 | 0.5±0.05 | H / N / Q / W |
| | | | | | CM05X5R105□16A# | 10.0 | 1.0±0.05 | 0.5±0.05 | 0.5±0.05 | H / N / Q / W |
| | | | | | CM05X5R105□10A# | 10.0 | 1.0±0.05 | 0.5±0.05 | 0.5±0.05 | H / N / Q / W |
| | 2.2μF | M:±20% | 25 | 10 | CM05X5R225M25AH | 12.5 | 1.0±0.20 | 0.5±0.20 | 0.5±0.20 | H |
| | | | | | CM05X5R225M25AH055 | 12.5 | 1.0±0.20 | 0.5±0.20 | 0.5± max. | H |
| | | | | | CM05X5R225□16A# | 12.5 | 1.0±0.05 | 0.5±0.05 | 0.5±0.05 | H / N / Q / W |
| | | | | | CM05X5R225□10A# | 12.5 | 1.0±0.05 | 0.5±0.05 | 0.5±0.05 | H / N / Q / W |
| | 4.7μF | M:±20% | 25 | 10 | CM05X5R475M25AH | 12.5 | 1.0±0.20 | 0.5±0.20 | 0.5±0.20 | H |
| | | | | | CM05X5R475M16AH | 12.5 | 1.0±0.20 | 0.5±0.20 | 0.5±0.20 | H |
| | | | | | CM05X5R475M10AH | 12.5 | 1.0±0.20 | 0.5±0.20 | 0.5±0.20 | H |
| | | | | | CM05X5R106M06AH | 12.5 | 1.0±0.20 | 0.5±0.20 | 0.5±0.20 | H |
| | 10μF | M:±20% | 6.3 | 4 | CM05X5R156M06AH | 12.5 | 1.0±0.15 | 0.5±0.15 | 0.5±0.15 | H / N(*) |
| CM05X5R156M04AH | | | | | 12.5 | 1.0±0.15 | 0.5±0.15 | 0.5±0.15 | H / N(*) | |
| 15μF | M:±20% | 6.3 | 4 | CM05X5R226M06AH080 | 12.5 | 1.0±0.20 | 0.5±0.20 | 0.8± max. | H | |
| | | | | CM05X5R226M04AH | 12.5 | 1.0±0.20 | 0.5±0.20 | 0.5±0.20 | H | |
| 22μF | M:±20% | 6.3 | 4 | CM05X5R226M04AH | 12.5 | 1.0±0.20 | 0.5±0.20 | 0.5±0.20 | H | |
| | | | | CM05X5R226M04A# | 12.5 | 1.0±0.05 | 0.5±0.05 | 0.5±0.05 | H / N / Q / W | |
| X7R | 0.10μF | K:±10% / M:±20% | 25 | CM05X7R104□25A# | 12.5 | 1.0±0.05 | 0.5±0.05 | 0.5±0.05 | H / N / Q / W | |
| X7S | 1.0μF | M:±20% | 4 | CM05X7S105M04AH | 12.5 | 1.0±0.05 | 0.5±0.05 | 0.5±0.05 | H / N / Q / W | |
| | | | | CM05X7S225M04A#065 | 5.0 | 1.0±0.15 | 0.5±0.15 | 0.5±0.15 | H / N(*) | |



Part Number List



General CM105 Series Size (JIS Code) : 0603(1608) # Packaging Code (Packaging quantity) : T(4,000pcs.) / L(10,000pcs.)

| Dielectric code | Capacitance | □:Tolerance | Voltage [V] | Part Number | Tanδ [%] | Dimension | | | # Packaging Code (quantity) |
|-----------------|-------------|-----------------|------------------|------------------|----------|-----------|----------|----------|-----------------------------|
| | | | | | | L[mm] | W[mm] | T[mm] | |
| X5R | 1.0μF | K:±10% / M:±20% | 25 | CM105X5R105□25A# | 12.5 | 1.6±0.15 | 0.8±0.15 | 0.8±0.15 | T / L |
| | | | 16 | CM105X5R225□16A# | 12.5 | 1.6±0.10 | 0.8±0.10 | 0.8±0.10 | T / L |
| | 4.7μF | M:±20% | 35 | CM105X5R475M35A# | 12.5 | 1.6±0.20 | 0.8±0.20 | 0.8±0.20 | T / L |
| | | | 25 | CM105X5R475□25A# | 12.5 | 1.6±0.20 | 0.8±0.20 | 0.8±0.20 | T / L |
| | | | 10 | CM105X5R475□10A# | 12.5 | 1.6±0.15 | 0.8±0.15 | 0.8±0.15 | T / L |
| | 10μF | M:±20% | 35 | CM105X5R106M35A# | 15.0 | 1.6±0.20 | 0.8±0.20 | 0.8±0.20 | T / L |
| 25 | | | CM105X5R106M25A# | 15.0 | 1.6±0.20 | 0.8±0.20 | 0.8±0.20 | T / L | |
| X6S | 10μF | M:±20% | 10 | CM105X6S106M10A# | 15.0 | 1.6±0.20 | 0.8±0.20 | 0.8±0.20 | T / L |
| X6T | 22μF | M:±20% | 4 | CM105X6T226M04A# | 12.5 | 1.6±0.25 | 0.8±0.25 | 0.8±0.25 | T |
| X7R | 1.0μF | K:±10% / M:±20% | 25 | CM105X7R105□25A# | 5.0 | 1.6±0.10 | 0.8±0.10 | 0.8±0.10 | T / L |
| | | | 16 | CM105X7R105□16A# | 12.5 | 1.6±0.10 | 0.8±0.10 | 0.8±0.10 | T / L |
| | | | 10 | CM105X7R105□10A# | 12.5 | 1.6±0.10 | 0.8±0.10 | 0.8±0.10 | T / L |
| | 2.2μF | K:±10% / M:±20% | 6.3 | CM105X7R225□06A# | 12.5 | 1.6±0.15 | 0.8±0.15 | 0.8±0.15 | T / L |
| X7T | 4.7μF | K:±10% / M:±20% | 10 | CM105X7T475□10A# | 12.5 | 1.6±0.20 | 0.8±0.20 | 0.8±0.20 | T / L |
| | 10μF | M:±20% | 6.3 | CM105X7T106M06A# | 15.0 | 1.6±0.20 | 0.8±0.20 | 0.8±0.20 | T / L |

General CM21 Series Size (JIS Code) : 0805(2012) # Packaging Code (Packaging quantity) : T(3,000pcs.) / L(10,000pcs.)

| Dielectric code | Capacitance | □:Tolerance | Voltage [V] | Part Number | Tanδ [%] | Dimension | | | # Packaging Code (quantity) | | |
|-----------------|-------------|-----------------|-----------------|------------------|-----------------|-----------------|-----------|-----------|-----------------------------|-----------|-------|
| | | | | | | L[mm] | W[mm] | T[mm] | | | |
| X5R | 1.0μF | K:±10% / M:±20% | 50 | CM21X5R105□50A# | 12.5 | 2.0±0.10 | 1.25±0.10 | 1.25±0.10 | T / L | | |
| | | | 25 | CM21X5R225□25A# | 12.5 | 2.0±0.20 | 1.25±0.20 | 1.25±0.20 | T / L | | |
| | 4.7μF | K:±10% / M:±20% | 25 | CM21X5R475□25A# | 12.5 | 2.0±0.20 | 1.25±0.20 | 1.25±0.20 | T / L | | |
| | | | 10μF | K:±10% / M:±20% | 16 | CM21X5R106□16A# | 12.5 | 2.0±0.20 | 1.25±0.20 | 1.25±0.20 | T / L |
| | | | 22μF | M:±20% | 10 | CM21X5R226M10A# | 12.5 | 2.0±0.20 | 1.25±0.20 | 1.25±0.20 | T / L |
| | X6S | 47μF | M:±20% | 6.3 | CM21X5R476M06A# | 10.0 | 2.0±0.20 | 1.25±0.20 | 1.25±0.20 | T / L | |
| 10 | | | | CM21X6S226M10A# | 12.5 | 2.0±0.20 | 1.25±0.20 | 1.25±0.20 | T / L | | |
| X7R | 2.2μF | M:±20% | 6.3 | CM21X6S226M06A# | 12.5 | 2.0±0.20 | 1.25±0.20 | 1.25±0.20 | T / L | | |
| | | | 4 | CM21X6S476M04A# | 10.0 | 2.0±0.20 | 1.25±0.20 | 1.25±0.20 | T / L | | |
| | 1.0μF | K:±10% / M:±20% | 50 | CM21X7R105□50A# | 5.0 | 2.0±0.20 | 1.25±0.20 | 1.25±0.20 | T / L | | |
| | | | 25 | CM21X7R105□25A# | 12.5 | 2.0±0.10 | 1.25±0.10 | 1.25±0.10 | T / L | | |
| | | | 25 | CM21X7R225□25A# | 12.5 | 2.0±0.20 | 1.25±0.20 | 1.25±0.20 | T / L | | |
| | X7S | 4.7μF | K:±10% / M:±20% | 16 | CM21X7R475□16A# | 12.5 | 2.0±0.20 | 1.25±0.20 | 1.25±0.20 | T / L | |
| 6.3 | | | | CM21X7R106□06A# | 12.5 | 2.0±0.20 | 1.25±0.20 | 1.25±0.20 | T / L | | |
| X7T | 1.0μF | K:±10% / M:±20% | 100 | CM21X7S105□100A# | 5.0 | 2.0±0.20 | 1.25±0.20 | 1.25±0.20 | T / L | | |
| X7T | 22μF | M:±20% | 6.3 | CM21X7T226M06A# | 12.5 | 2.0±0.20 | 1.25±0.20 | 1.25±0.20 | T / L | | |

General CM316 Series Size (JIS Code) : 1206(3216) # Packaging Code (Packaging quantity) : T(2,500pcs.)(*2,000pcs.) / L(5,000pcs.)

| Dielectric code | Capacitance | □:Tolerance | Voltage [V] | Part Number | Tanδ [%] | Dimension | | | # Packaging Code (quantity) |
|-----------------|-------------|-----------------|-------------|-------------------|----------|-----------|----------|----------|-----------------------------|
| | | | | | | L[mm] | W[mm] | T[mm] | |
| X5R | 2.2μF | K:±10% / M:±20% | 100 | CM316X5R225□100A# | 5.0 | 3.2±0.20 | 1.6±0.20 | 1.6±0.20 | T / L |
| | | | 25 | CM316X5R225□25A# | 5.0 | 3.2±0.20 | 1.6±0.15 | 1.6±0.15 | T / L |
| | 4.7μF | K:±10% / M:±20% | 50 | CM316X5R475□50A# | 5.0 | 3.2±0.20 | 1.6±0.20 | 1.6±0.20 | T / L |
| | | | 25 | CM316X5R106□25A# | 12.5 | 3.2±0.20 | 1.6±0.20 | 1.6±0.20 | T / L |
| | | | 16 | CM316X5R226□16A# | 12.5 | 3.2±0.20 | 1.6±0.20 | 1.6±0.20 | T / L |
| X7R | 4.7μF | K:±10% / M:±20% | 50 | CM316X7R475□50A# | 5.0 | 3.2±0.20 | 1.6±0.20 | 1.6±0.20 | T / L |
| | | | 25 | CM316X7R106□25A# | 5.0 | 3.2±0.20 | 1.6±0.20 | 1.6±0.20 | T / L |
| | 10μF | K:±10% / M:±20% | 16 | CM316X7R106□16A# | 12.5 | 3.2±0.20 | 1.6±0.20 | 1.6±0.20 | T / L |
| | | | 10 | CM316X7R226□10A# | 7.5 | 3.2±0.20 | 1.6±0.20 | 1.6±0.20 | T / L |
| X7S | 2.2μF | K:±10% / M:±20% | 6.3 | CM316X7R226□06A# | 12.5 | 3.2±0.20 | 1.6±0.20 | 1.6±0.20 | T / L |
| | | | 100 | CM316X7S225□100A# | 5.0 | 3.2±0.20 | 1.6±0.20 | 1.6±0.20 | T / L |
| | 4.7μF | K:±10% / M:±20% | 100 | CM316X7S475□100AT | 5.0 | 3.2±0.30 | 1.6±0.30 | 1.6±0.30 | T(*) |
| X7T | 22μF | K:±10% / M:±20% | 10 | CM316X7S226□10A# | 7.5 | 3.2±0.20 | 1.6±0.20 | 1.6±0.20 | T / L |

General CM32 Series Size (JIS Code) : 1210(3225) # Packaging Code (Packaging quantity) : T(1,000pcs.) / L(4,000pcs.)

| Dielectric code | Capacitance | □:Tolerance | Voltage [V] | Part Number | Tanδ [%] | Dimension | | | # Packaging Code (quantity) |
|-----------------|-------------|-----------------|-------------|-----------------|----------|-----------|----------|----------|-----------------------------|
| | | | | | | L[mm] | W[mm] | T[mm] | |
| X5R | 10μF | K:±10% / M:±20% | 50 | CM32X5R106□50A# | 5.0 | 3.2±0.30 | 2.5±0.20 | 2.5±0.20 | T / L |
| | | | 25 | CM32X5R106□25A# | 12.5 | 3.2±0.30 | 2.5±0.20 | 2.5±0.20 | T / L |
| | | | 16 | CM32X5R106□16A# | 5.0 | 3.2±0.30 | 2.5±0.20 | 2.5±0.20 | T / L |
| X7R | 10μF | K:±10% / M:±20% | 25 | CM32X5R226□25A# | 12.5 | 3.2±0.30 | 2.5±0.20 | 2.5±0.20 | T / L |
| | | | 50 | CM32X7R106□50A# | 5.0 | 3.2±0.30 | 2.5±0.20 | 2.5±0.20 | T / L |
| | | | 25 | CM32X7R106□25A# | 12.5 | 3.2±0.30 | 2.5±0.20 | 2.5±0.20 | T / L |
| X7R | 22μF | K:±10% / M:±20% | 16 | CM32X7R226□16A# | 12.5 | 3.2±0.30 | 2.5±0.20 | 2.5±0.20 | T / L |



1. Specifications described in this catalog are for references. Products specifications shall be based on written documents agreed by each party.
2. Contents in this catalog are subject to change without notice. It is recommended to confirm the latest information at the time of usage. Also, Kyocera Electronic Components Catalog is revised once a year. We may not be able to accept requests based on old catalogs.
3. Products in this catalog are intended to be used in general electronic equipment such as office equipment, audio and visual equipment, communication equipment, measurement instrument and home appliances. It is absolutely recommended to consult with our sales representatives in advance upon planning to use our products in applications which require extremely high quality and reliability such as aircraft and aerospace equipment, traffic systems, safety systems, power plant and medical equipment including life maintenance systems.
4. Even though we strive for improvements of quality and reliability of products, it is requested to design with enough safety margin in equipment or systems in order not to threaten human lives directly or damage human bodies or properties by an accidental result of products.
5. It is requested to design based on guaranteed specifications for such as maximum ratings, operating voltage and operating temperature. It is not the scope of our guarantee for unsatisfactory results due to misuse or inadequate usage of products in the catalog.
6. Operation summaries and circuit examples in this catalog are intended to explain typical operation and usage of the product. It is recommended to perform circuit and assembly design considering surrounding conditions upon using products in this catalog.
7. Technical information described in this catalog is meant to explain typical operations and applications of products, and it is not intended to guarantee or license intellectual properties or other industrial rights of the third party or Kyocera.
8. Trademarks, logos and brand names used in this catalog are owned by Kyocera or the corresponding third party.
9. Certain products in this catalog are subject to the Foreign Exchange and Foreign Trade Control Act of Japan, and require the license from Japanese Government upon exporting the restricted products and technical information under the law.
Besides, it is requested not to use products and technical information in the catalog for the development and/or manufacture of weapons of mass destruction or other conventional weapons, nor to provide them to any third party with the possibility of having such purposes.
10. It is prohibited to reprint and reproduce a part or whole of this catalog without permission.
11. Contents described herein are as of October 2020.

Design Tool Introduction

Part Number, environmental documents, and other data can be searched with cap value, case size, or electrical characteristic of MLCC.

<http://prdct-search.kyocera.co.jp/electro-mlcc-en/>

