



**5 mm Low profile,
2 Form C and 2 A(surface-
mount type) relays**

TQ RELAYS



FEATURES

1. **Flat compact size**
14.0 (L)×9.0 (W)×5.0 (H) mm
.551 (L)×.354 (W)×.197 (H) inch
2. **Nominal operating power:**
High sensitivity of 140mW (2 Form C single side stable type)
3. **Outstanding surge resistance.**
4. **FCC Part 68: 1,500 V 10×160 μs**
(open contacts)
Surface-mount type meet Telcordia
Telcordia: 2,500 V 2×10 μs
(contact and coil)
5. **DIL terminal array enables use of IC sockets**
6. **Low thermal electromotive force**
(approx. 5 μV)
[approx. 2 μV (surface-mount type)]
7. **Latching types also available**
8. **Self-clinching terminal also available**

8. A range of surface-mount types is also available

- SA: Low-profile surface-mount terminal type
- SL: High connection reliability surfacemount terminal type
- SS: Space saving surface-mount terminal type

9. M.B.B. contact types available

TYPICAL APPLICATIONS

1. Telephone-related equipment
2. Communications
3. Measurement equipment
4. OA equipment
5. Industrial machines

ORDERING INFORMATION

TQ **2** - - - - -

Contact arrangement
2: 2 Form C

Terminal shape
Nil: Standard PC board terminal
H: Self-clinching terminal
SA: SA type
SL: SL type
SS: SS type

Operating function
Nil: Single side stable
L: 1 coil latching
L2: 2 coil latching

MBB function
Nil: Standard (B.B.M.) type
2M: 2M.B.B. type

Nominal coil voltage (DC)^{*1,2}
1.5 (SMD only), 3, 4.5, 5, 6, 9, 12, 24, 48V

Packing style^{*3}
Nil: Tube packing
X: Tape and reel (picked from 1/2/3/4/5-pin side)
W: Tape and reel packing (picked from the 1/2/3/4/5-pin side)
With humidity indicator and silica gel in moisture proof bag
Z: Tape and reel packing (picked from the 6/7/8/9/10-pin side)
Y: Tape and reel packing (picked from the 6/7/8/9/10-pin side)
With humidity indicator and silica gel in moisture proof bag

Note 1) *48 V coil type: Single side stable only
Note 2) In case of 5 V transistor drive circuit, it is recommended to use 4.5 V type relay.
Note 3) The "W" and "Y" at the end of the part number is only available for SA and SS.

TYPES

■ Standard PC board terminal and self-clinching terminal

1. Standard (B.B.M.) type

1) Standard PC board terminal

| Contact arrangement | Nominal coil voltage | Single side stable | 1 coil latching | 2 coil latching |
|---------------------|----------------------|--------------------|-----------------|-----------------|
| | | Part No. | Part No. | Part No. |
| 2 Form C | 3 V DC | TQ2-3V | TQ2-L-3V | TQ2-L2-3V |
| | 4.5 V DC | TQ2-4.5V | TQ2-L-4.5V | TQ2-L2-4.5V |
| | 5 V DC | TQ2-5V | TQ2-L-5V | TQ2-L2-5V |
| | 6 V DC | TQ2-6V | TQ2-L-6V | TQ2-L2-6V |
| | 9 V DC | TQ2-9V | TQ2-L-9V | TQ2-L2-9V |
| | 12 V DC | TQ2-12V | TQ2-L-12V | TQ2-L2-12V |
| | 24 V DC | TQ2-24V | TQ2-L-24V | TQ2-L2-24V |
| | 48 V DC | TQ2-48V | — | — |

Standard packing (2 Form C): Tube: 50 pcs.; Case: 1,000 pcs.

2. Self-clinching terminal

| Contact arrangement | Nominal coil voltage | Single side stable | 1 coil latching | 2 coil latching |
|---------------------|----------------------|--------------------|-----------------|-----------------|
| | | Part No. | Part No. | Part No. |
| 2 Form C | 3 V DC | TQ2H-3V | TQ2H-L-3V | TQ2H-L2-3V |
| | 4.5 V DC | TQ2H-4.5V | TQ2H-L-4.5V | TQ2H-L2-4.5V |
| | 5 V DC | TQ2H-5V | TQ2H-L-5V | TQ2H-L2-5V |
| | 6 V DC | TQ2H-6V | TQ2H-L-6V | TQ2H-L2-6V |
| | 9 V DC | TQ2H-9V | TQ2H-L-9V | TQ2H-L2-9V |
| | 12 V DC | TQ2H-12V | TQ2H-L-12V | TQ2H-L2-12V |
| | 24 V DC | TQ2H-24V | TQ2H-L-24V | TQ2H-L2-24V |
| | 48 V DC | TQ2H-48V | — | — |

Note: Types ("-3" to the end of part No.) designed to withstand strong vibration caused, for example, by the use of terminal cutters, can also be ordered. However, please contact us if you need parts for use in low level load.

2. M.B.B. type

1) Standard PC board terminal

| Contact arrangement | Nominal coil voltage | Single side stable |
|---------------------|----------------------|--------------------|
| | | Part No. |
| 2 Form C | 3 V DC | TQ2-2M-3V |
| | 4.5 V DC | TQ2-2M-4.5V |
| | 5 V DC | TQ2-2M-5V |
| | 6 V DC | TQ2-2M-6V |
| | 9 V DC | TQ2-2M-9V |
| | 12 V DC | TQ2-2M-12V |
| | 24 V DC | TQ2-2M-24V |

Standard packing: Tube: 50 pcs.; Case: 1,000 pcs.

2) Self-clinching terminal

| Contact arrangement | Nominal coil voltage | Single side stable |
|---------------------|----------------------|--------------------|
| | | Part No. |
| 2 Form C | 3 V DC | TQ2H-2M-3V |
| | 4.5 V DC | TQ2H-2M-4.5V |
| | 5 V DC | TQ2H-2M-5V |
| | 6 V DC | TQ2H-2M-6V |
| | 9 V DC | TQ2H-2M-9V |
| | 12 V DC | TQ2H-2M-12V |
| | 24 V DC | TQ2H-2M-24V |

Standard packing: Tube: 50 pcs.; Case: 1,000 pcs.

Notes: 1. Latching types are available by request. Please consult us for details.

2. UL/CSA approved (UL file No.:E 43149, CSA file No.: LR26550)

3. Types ("-1" to the end of part No.) designed to withstand strong vibration caused, for example, by the use of terminal cutters, can also be ordered.

However, please contact us if you need parts for use in low level load and low thermal power.

■ Surface-mount terminal

1) Tube packing

| Contact arrangement | Nominal coil voltage | Single side stable | 1 coil latching | 2 coil latching |
|---------------------|----------------------|--------------------|-----------------|-----------------|
| | | Part No. | Part No. | Part No. |
| 2c | 1.5 V DC | TQ2S□-1.5V | TQ2S□-L-1.5V | TQ2S□-L2-1.5V |
| | 3 V DC | TQ2S□-3V | TQ2S□-L-3V | TQ2S□-L2-3V |
| | 4.5 V DC | TQ2S□-4.5V | TQ2S□-L-4.5V | TQ2S□-L2-4.5V |
| | 5 V DC | TQ2S□-5V | TQ2S□-L-5V | TQ2S□-L2-5V |
| | 6 V DC | TQ2S□-6V | TQ2S□-L-6V | TQ2S□-L2-6V |
| | 9 V DC | TQ2S□-9V | TQ2S□-L-9V | TQ2S□-L2-9V |
| | 12 V DC | TQ2S□-12V | TQ2S□-L-12V | TQ2S□-L2-12V |
| | 24 V DC | TQ2S□-24V | TQ2S□-L-24V | TQ2S□-L2-24V |
| | 48 V DC | TQ2S□-48V | — | — |

□: For each surface-mounted terminal identification, input the following letter. SA type: A, SS type: S
Standard packing: Tube: 50 pcs.; Case: 1,000 pcs.

2) Tape and reel packing

| Contact arrangement | Nominal coil voltage | Single side stable | 1 coil latching | 2 coil latching |
|---------------------|----------------------|--------------------|-----------------|-----------------|
| | | Part No. | Part No. | Part No. |
| 2 Form C | 1.5 V DC | TQ2S□-1.5V-Z | TQ2S□-L-1.5V-Z | TQ2S□-L2-1.5V-Z |
| | 3 V DC | TQ2S□-3V-Z | TQ2S□-L-3V-Z | TQ2S□-L2-3V-Z |
| | 4.5 V DC | TQ2S□-4.5V-Z | TQ2S□-L-4.5V-Z | TQ2S□-L2-4.5V-Z |
| | 5 V DC | TQ2S□-5V-Z | TQ2S□-L-5V-Z | TQ2S□-L2-5V-Z |
| | 6 V DC | TQ2S□-6V-Z | TQ2S□-L-6V-Z | TQ2S□-L2-6V-Z |
| | 9 V DC | TQ2S□-9V-Z | TQ2S□-L-9V-Z | TQ2S□-L2-9V-Z |
| | 12 V DC | TQ2S□-12V-Z | TQ2S□-L-12V-Z | TQ2S□-L2-12V-Z |
| | 24 V DC | TQ2S□-24V-Z | TQ2S□-L-24V-Z | TQ2S□-L2-24V-Z |
| | 48 V DC | TQ2S□-48V-Z | — | — |

□: For each surface-mounted terminal identification, input the following letter. SA type: A, SS type: S
Standard packing: Tape and reel: 500 pcs.; Case: 1,000 pcs.

- Notes: 1. Tape and reel packing symbol "Z" is not marked on the relay. "X" type tape and reel packing (picked from 1/2/3/4-pin side) is also available.
2. Tape and reel packing symbol "Y" is not marked on the relay. "W" type tape and reel packing (picked from 1/2/3/4-pin side) is also available.
3. Please add "-1" to the end of the part number for AgPd contacts (low level load).

RATING

■ Standard PC board terminal and self-clinching terminal

1.Coil data

- Operating characteristics such as 'Operate voltage' and 'Release voltage' are influenced by mounting conditions, ambient temperature, etc.
Therefore, please use the relay within $\pm 5\%$ of rated coil voltage.
- 'Initial' means the condition of products at the time of delivery.

[Standard (B.B.M.) type]

1) Single side stable (2 Form C)

| Nominal coil voltage | Pick-up voltage (at 20°C 68°F) | Drop-out voltage (at 20°C 68°F) | Nominal operating current [$\pm 10\%$] (at 20°C 68°F) | Coil resistance [$\pm 10\%$] (at 20°C 68°F) | Nominal operating power | Max. applied voltage (at 20°C 68°F) |
|----------------------|--|--|---|---|-------------------------|-------------------------------------|
| 3 V DC | 75%V or less of nominal voltage* (Initial) | 10%V or more of nominal voltage* (Initial) | 46.7 mA | 64.3 Ω | 140 mW | 150%V of nominal voltage |
| 4.5 V DC | | | 31.1 mA | 144.6 Ω | | |
| 5 V DC | | | 28.1 mA | 178 Ω | | |
| 6 V DC | | | 23.3 mA | 257 Ω | | |
| 9 V DC | | | 15.5 mA | 579 Ω | | |
| 12 V DC | | | 11.7 mA | 1,028 Ω | | |
| 24 V DC | | | 8.3 mA | 2,880 Ω | 200 mW | |
| 48 V DC | | | 6.25 mA | 7,680 Ω | 300 mW | 120%V of nominal voltage |

2) 1 coil latching (2 Form C)

| Nominal coil voltage | Set voltage (at 20°C 68°F) | Reset voltage (at 20°C 68°F) | Nominal operating current [$\pm 10\%$] (at 20°C 68°F) | Coil resistance [$\pm 10\%$] (at 20°C 68°F) | Nominal operating power | Max. applied voltage (at 20°C 68°F) |
|----------------------|--|--|---|---|-------------------------|-------------------------------------|
| 3 V DC | 75%V or less of nominal voltage* (Initial) | 75%V or less of nominal voltage* (Initial) | 33.3 mA | 90 Ω | 100 mW | 150%V of nominal voltage |
| 4.5 V DC | | | 22.2 mA | 202.5 Ω | | |
| 5 V DC | | | 20 mA | 250 Ω | | |
| 6 V DC | | | 16.7 mA | 360 Ω | | |
| 9 V DC | | | 11.1 mA | 810 Ω | | |
| 12 V DC | | | 8.3 mA | 1,440 Ω | | |
| 24 V DC | | | 6.3 mA | 3,840 Ω | 150 mW | |

3) 2 coil latching (2 Form C)

| Nominal coil voltage | Set voltage (at 20°C 68°F) | Reset voltage (at 20°C 68°F) | Nominal operating current [±10%] (at 20°C 68°F) | | Coil resistance [±10%] (at 20°C 68°F) | | Nominal operating power | | Max. applied voltage (at 20°C 68°F) |
|----------------------|--|--|---|------------|---------------------------------------|------------|-------------------------|------------|-------------------------------------|
| | | | Set coil | Reset coil | Set coil | Reset coil | Set coil | Reset coil | |
| 3 V DC | 75%V or less of nominal voltage* (Initial) | 75%V or less of nominal voltage* (Initial) | 66.7 mA | 66.7 mA | 45 Ω | 45 Ω | 200 mW | 200 mW | 150%V of nominal voltage |
| 4.5 V DC | | | 44.4 mA | 44.4 mA | 101.2Ω | 101.2Ω | | | |
| 5 V DC | | | 40 mA | 40 mA | 125 Ω | 125 Ω | | | |
| 6 V DC | | | 33.3 mA | 33.3 mA | 180 Ω | 180 Ω | | | |
| 9 V DC | | | 22.2 mA | 22.2 mA | 405 Ω | 405 Ω | | | |
| 12 V DC | | | 16.7 mA | 16.7 mA | 720 Ω | 720 Ω | | | |
| 24 V DC | | | 12.5 mA | 12.5 mA | 1,920 Ω | 1,920 Ω | 300 mW | 300 mW | 120%V of nominal voltage |

[M.B.B. type]

| Nominal coil voltage | Pick-up voltage (at 20°C 68°F) | Drop-out voltage (at 20°C 68°F) | Nominal operating current [±10%] (at 20°C 68°F) | Coil resistance [±10%] (at 20°C 68°F) | Nominal operating power | Max. applied voltage (at 20°C 68°F) |
|----------------------|--|--|---|---------------------------------------|-------------------------|-------------------------------------|
| 3 V DC | 80%V or less of nominal voltage* (Initial) | 10%V or more of nominal voltage* (Initial) | 66.7 mA | 45 Ω | 200 mW | 150%V of nominal voltage |
| 4.5 V DC | | | 44.4 mA | 101 Ω | | |
| 5 V DC | | | 40 mA | 125 Ω | | |
| 6 V DC | | | 33.3 mA | 180 Ω | | |
| 9 V DC | | | 22.2 mA | 405 Ω | | |
| 12 V DC | | | 16.7 mA | 720 Ω | | |
| 24 V DC | | | 8.3 mA | 2,880 Ω | | |

*Pulse drive (JIS C 5442-1986)

2. Specifications

| Characteristics | Item | Specifications | |
|--|---|--|--|
| Contact | Arrangement | 2 Form C, 2 Form D (M.B.B.) | |
| | Initial contact resistance, max. | Max. 50mΩ (By voltage drop 6 V DC 1A) | |
| | Contact material | Ag+Au clad | |
| Rating | Nominal switching capacity | 1 A 30 V DC, 0.5 A 125 V AC (resistive load) | |
| | Max. switching power | 30 W (DC), 62.5 V A (AC) (resistive load) | |
| | Max. switching voltage | 110 V DC, 125 V AC | |
| | Max. switching current | 1 A | |
| | Min. switching capacity (Reference value)*1 | 10μA 10mV DC | |
| | Nominal operating power | Single side stable 1 coil latching 2 coil latching | Standard (B.B.M) type: 140 mW (3 to 12 V DC), 200 mW (24 V DC), 300 mW (48 V DC) M.B.B. type: 200 mW 100 mW (3 to 12 V DC), 150 mW (24 V DC) 200 mW (3 to 12 V DC), 300 mW (24 V DC) |
| Electrical characteristics | Insulation resistance (Initial) | Min. 1,000MΩ (at 500V DC) Measurement at same location as "Initial breakdown voltage" section. | |
| | Breakdown voltage (Initial) | Between open contacts | Standard (B.B.M) type: 750 Vrms for 1min. (Detection current: 10 mA), M.B.B. type: 300 Vrms for 1 min. (Detection current: 10 mA) |
| | | Between contact and coil | 1,000 Vrms for 1min. (Detection current: 10 mA) |
| | | Between contact sets | 1,000 Vrms for 1min. (Detection current: 10 mA) |
| | Surge breakdown voltage (Initial) | Between open contacts | 1,500 V (10×160μs) (FCC Part 68) |
| | Temperature rise (at 20°C 68°F) | | Max. 50°C (By resistive method, nominal coil voltage applied to the coil; contact carrying current: 1A.) |
| Operate time [Set time] (at 20°C 68°F) | | Max. 3 ms [Max. 3 ms] (Nominal coil voltage applied to the coil, excluding contact bounce time.) | |
| Release time [Reset time] (at 20°C 68°F) | | Max. 3 ms [Max. 3 ms] (Nominal coil voltage applied to the coil, excluding contact bounce time.) (without diode) | |
| Mechanical characteristics | Shock resistance | Functional | Min. 490 m/s ² (Half-wave pulse of sine wave: 11 ms; detection time: 10μs.) |
| | | Destructive | Min. 980 m/s ² (Half-wave pulse of sine wave: 6 ms.) |
| | Vibration resistance | Functional | 10 to 55 Hz at double amplitude of 3 mm (Detection time: 10μs.) |
| | | Destructive | 10 to 55 Hz at double amplitude of 5 mm |
| Expected life | Mechanical (at 180 cpm) | | Standard (B.B.M) type: Min. 10 ⁸ , M.B.B. type: Min. 10 ⁷ |
| | Electrical (at 20 cpm) | | Standard (B.B.M) type: Min. 2×10 ⁵ (1 A 30 V DC resistive), Min. 10 ⁵ (0.5 A 125 V AC resistive) M.B.B. type: Min. 10 ⁵ (1 A 30 V DC resistive) |
| Conditions | Conditions for operation, transport and storage*2 | | Standard (B.B.M) type: Ambient temperature: -40°C to +70°C -40°F to +158°F; Humidity: 5 to 85% R.H. (Not freezing and condensing at low temperature) M.B.B. type: Ambient temperature: -40°C to +50°C -40°F to +122°F; Humidity: 5 to 85% R.H. (Not freezing and condensing at low temperature) |
| | Max. operating speed (at rated load) | | 20 cpm |
| Unit weight | | | Approx. 1.5 g .053 oz |

Notes: *1 This value can change due to the switching frequency, environmental conditions, and desired reliability level, therefore it is recommended to check this with the actual load. TX/TX-S/TX-D relay AgPd contact type are available for low level load switching (10V DC, 10mA max. level).

*2 Refer to "AMBIENT ENVIRONMENT" in GENERAL APPLICATION GUIDELINES.

■ Surface-mount terminal

1. Coil data

1) Single side stable

| Nominal coil voltage | Pick-up voltage (at 20°C 68°F) | Drop-out voltage (at 20°C 68°F) | Nominal operating current (at 20°C 68°F) | Coil resistance [±10%](at 20°C 68°F) | Nominal operating power | Max. applied voltage (at 20°C 68°F) |
|----------------------|--|--|--|--------------------------------------|-------------------------|-------------------------------------|
| 1.5 V DC | 75%V or less of nominal voltage* (Initial) | 10%V or more of nominal voltage* (Initial) | 93.8 mA | 16 Ω | 140 mW | 150%V of nominal voltage |
| 3 V DC | | | 46.7 mA | 64.3 Ω | | |
| 4.5 V DC | | | 31 mA | 145 Ω | | |
| 5 V DC | | | 28.1 mA | 178 Ω | | |
| 6 V DC | | | 23.3 mA | 257 Ω | | |
| 9 V DC | | | 15.5 mA | 579 Ω | | |
| 12 V DC | | | 11.7 mA | 1,028 Ω | 200 mW | |
| 24 V DC | | | 8.3 mA | 2,880 Ω | | |
| 48 V DC | | | | | 6.3 mA | 7,680 Ω |

2) 1 coil latching

| Nominal coil voltage | Set voltage (at 20°C 68°F) | Reset voltage (at 20°C 68°F) | Nominal operating current (at 20°C 68°F) | Coil resistance [±10%](at 20°C 68°F) | Nominal operating power | Max. applied voltage (at 20°C 68°F) |
|----------------------|--|--|--|--------------------------------------|-------------------------|-------------------------------------|
| 1.5 V DC | 75%V or less of nominal voltage* (Initial) | 75%V or less of nominal voltage* (Initial) | 46.9 mA | 32 Ω | 70 mW | 150%V of nominal voltage |
| 3 V DC | | | 23.3 mA | 128.6 Ω | | |
| 4.5 V DC | | | 15.6 mA | 289.3 Ω | | |
| 5 V DC | | | 14 mA | 357 Ω | | |
| 6 V DC | | | 11.7 mA | 514 Ω | | |
| 9 V DC | | | 7.8 mA | 1,157 Ω | | |
| 12 V DC | | | 5.8 mA | 2,057 Ω | 100 mW | |
| 24 V DC | | | 4.2 mA | 5,760 Ω | | |

3) 2 coil latching

| Nominal coil voltage | Set voltage (at 20°C 68°F) | Reset voltage (at 20°C 68°F) | Nominal operating current (at 20°C 68°F) | | Coil resistance [±10%](at 20°C 68°F) | | Nominal operating power | | Max. applied voltage (at 20°C 68°F) |
|----------------------|--|--|--|------------|--------------------------------------|------------|-------------------------|------------|-------------------------------------|
| | | | Set coil | Reset coil | Set coil | Reset coil | Set coil | Reset coil | |
| 1.5 V DC | 75%V or less of nominal voltage* (Initial) | 75%V or less of nominal voltage* (Initial) | 93.8 mA | 93.8 mA | 16 Ω | 16 Ω | 140 mW | 140 mW | 150%V of nominal voltage |
| 3 V DC | | | 46.7 mA | 46.7 mA | 64.3 Ω | 64.3 Ω | | | |
| 4.5 V DC | | | 31 mA | 31 mA | 145 Ω | 145 Ω | | | |
| 5 V DC | | | 28.1 mA | 28.1 mA | 178 Ω | 178 Ω | | | |
| 6 V DC | | | 23.3 mA | 23.3 mA | 257 Ω | 257 Ω | | | |
| 9 V DC | | | 15.5 mA | 15.5 mA | 579 Ω | 579 Ω | | | |
| 12 V DC | | | 11.7 mA | 11.7 mA | 1,028 Ω | 1,028 Ω | 200 mW | 200 mW | |
| 24 V DC | | | 8.3 mA | 8.3 mA | 2,880 Ω | 2,880 Ω | | | |

*Pulse drive (JIS C 5442-1986)

2. Specifications

| Characteristics | Item | Specifications | |
|--|--|---|---|
| Contact | Arrangement | 2 Form C | |
| | Initial contact resistance, max. | Max. 75 mΩ (By voltage drop 6 V DC 1A) | |
| | Contact material | AgNi type+Au clad | |
| Rating | Nominal switching capacity | 2 A 30 V DC, 0.5 A 125 V AC (resistive load) | |
| | Max. switching power | 60 W (DC), 62.5 VA (AC) (resistive load) | |
| | Max. switching voltage | 220 V DC, 125 V AC | |
| | Max. switching current | 2 A | |
| | Min. switching capacity (Reference value)*1 | 10μA 10mV DC | |
| | Nominal operating power | Single side stable | 140 mW (1.5 to 12 V DC), 200 mW (24 V DC), 300 mW (48 V DC) |
| 1 coil latching | | 70 mW (1.5 to 12 V DC), 100 mW (24 V DC) | |
| 2 coil latching | | 140 mW (1.5 to 12 V DC), 200 mW (24 V DC) | |
| Electrical characteristics | Insulation resistance (Initial) | Min. 1,000MΩ (at 500V DC) Measurement at same location as "Initial breakdown voltage" section. | |
| | Breakdown voltage (Initial) | Between open contacts | 1,000 Vrms for 1 min. (Detection current: 10 mA) |
| | | Between contact and coil | 1,500 Vrms for 1 min. (Detection current: 10 mA) |
| | | Between contact sets | 1,500 Vrms for 1 min. (Detection current: 10 mA) |
| | Surge breakdown voltage (Initial) | Between open contacts | 1,500 V (10×160μs) (FCC Part 68) |
| | | Between contacts and coil | 2,500 V (2×10μs) (Telcordia) |
| | Temperature rise (at 20°C 68°F) | Max. 50°C (By resistive method, nominal coil voltage applied to the coil; contact carrying current: 2A.) | |
| | Operate time [Set time] (at 20°C 68°F) | Max. 4 ms [Max. 4 ms] (Nominal coil voltage applied to the coil, excluding contact bounce time.) | |
| Release time [Reset time] (at 20°C 68°F) | Max. 4 ms [Max. 4 ms] (Nominal coil voltage applied to the coil, excluding contact bounce time.) (without diode) | | |
| Mechanical characteristics | Shock resistance | Functional | Min. 750 m/s ² (Half-wave pulse of sine wave: 6 ms; detection time: 10μs.) |
| | | Destructive | Min. 1,000 m/s ² (Half-wave pulse of sine wave: 6 ms.) |
| | Vibration resistance | Functional | 10 to 55 Hz at double amplitude of 3.3 mm (Detection time: 10μs.) |
| | | Destructive | 10 to 55 Hz at double amplitude of 5 mm |
| Expected life | Mechanical | Min. 10 ⁸ (at 180 cpm) | |
| | Electrical | Min. 10 ⁵ (2 A 30 V DC resistive), Min. 2×10 ⁵ (1 A 30 V DC resistive), Min. 10 ⁵ (0.5 A 125 V AC resistive) (at 20 cpm) | |
| Conditions | Conditions for operation, transport and storage*2 | Ambient temperature: -40°C to +85°C -40°F to +185°F, Max. -40°C to +70°C (2A) Max. -40°F to +158°F (2A); Humidity: 5 to 85% R.H. (Not freezing and condensing at low temperature) | |
| | Max. operating speed (at rated load) | 20 cpm | |
| Unit weight | | Approx. 2 g .071 oz | |

Notes: *1 This value can change due to the switching frequency, environmental conditions, and desired reliability level, therefore it is recommended to check this with the actual load. (TX/TX-S/TX-D relay AgPd contact type are available for low level load switching [10V DC, 10mA max. level])

*2 Refer to "AMBIENT ENVIRONMENT" in GENERAL APPLICATION GUIDELINES.

REFERENCE DATA

■ Standard PC board terminal and self-clinching terminal

1. Maximum switching capacity



2. Life curve



3. Mechanical life

Tested sample: TQ2-12V, 10 pcs.

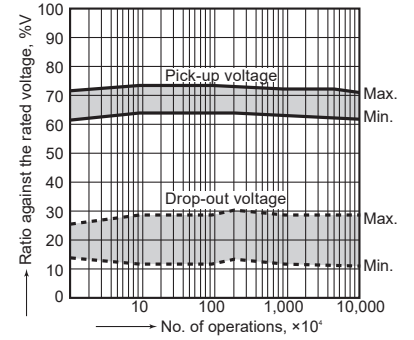

4.-(1) Electrical life (DC load)

Tested sample: TQ2-12V, 6 pcs.
Condition: 1 A 30 V DC resistive load, 20 cpm
Change of pick-up and drop-out voltage



Change of contact resistance



4.-(2) Electrical life (AC load)

Tested sample: TQ2-12V, 6 pcs.
Condition: 0.5 A 125 V AC resistive load, 20 cpm
Change of pick-up and drop-out voltage



Change of contact resistance



5. Coil temperature rise (2C)

Tested sample: TQ2-12V
Measured portion: Inside the coil
Ambient temperature: 30°C 86°F



6. Ambient temperature characteristics

Tested sample: TQ2-12V, 5 pcs.



7.-(1) High-frequency characteristics (Isolation)

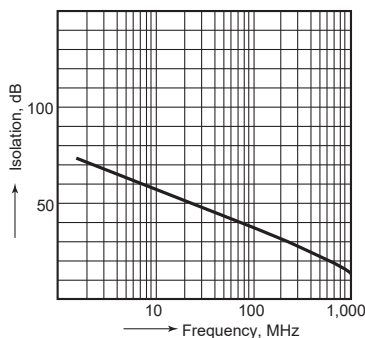

7.-(2) High-frequency characteristics (Insertion loss)

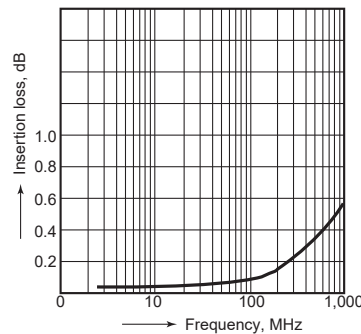

8. Malfunctional shock (single side stable)

Tested sample: TQ2-12V, 6 pcs.

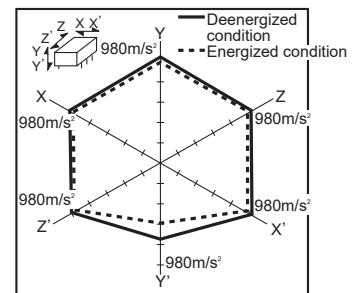

9.-(1) Influence of adjacent mounting



9.-(2) Influence of adjacent mounting



10. Contact reliability
(1 mA 5 V DC resistive load)
Tested sample: TQ2-12V
Condition: Detection level 10 W



11. Actual load test (35 mA 48 V DC wire spring relay load)

Circuit



Change of pick-up and drop-out voltage

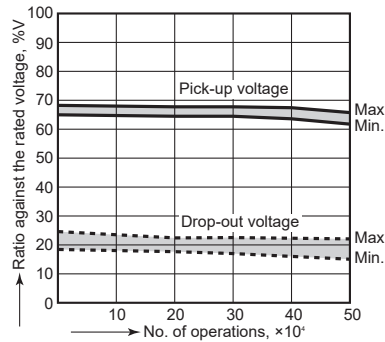

Change of contact resistance



12. 0.1 A 53 V DC resistive load test
Change of pick-up and drop-out voltage

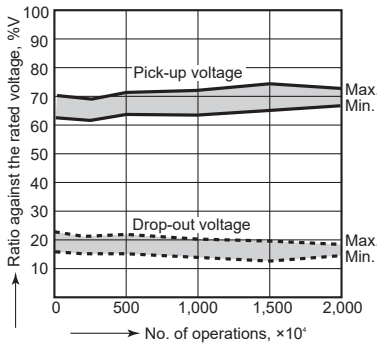

Change of contact resistance

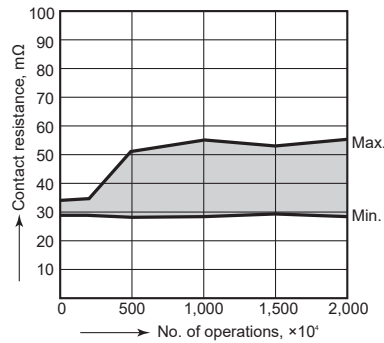

13. Distribution of M.B.B. time
Tested sample: TQ2-2M-5V, 85 pcs.



■ Surface-mount terminal

1. Maximum switching capacity



2. Life curve



3. Mechanical life (mounting by IRS method)

Tested sample: TQ2SA-12V, 10 pcs.



4.-(1) Electrical life (2 A 30 V DC resistive load)

Tested sample: TQ2SA-12V, 6 pcs.

Operating speed: 20 cpm

Change of pick-up and drop-out voltage (mounting by IRS method)

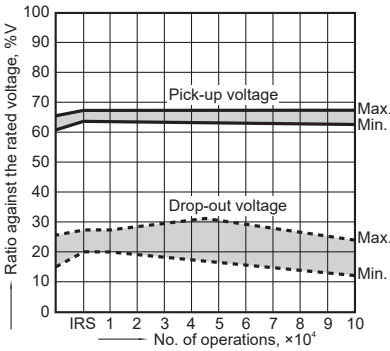

Change of contact resistance (mounting by IRS method)

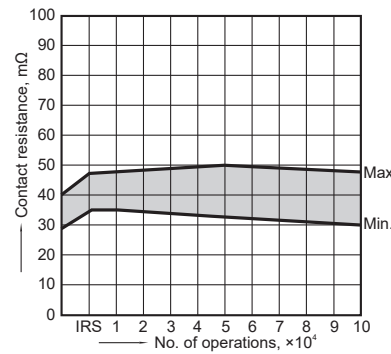

4.-(2) Electrical life (0.5 A 125 V AC resistive load)

Tested sample: TQ2SA-12V, 6 pcs

Operating speed: 20 cpm

Change of pick-up and drop-out voltage (mounting by IRS method)

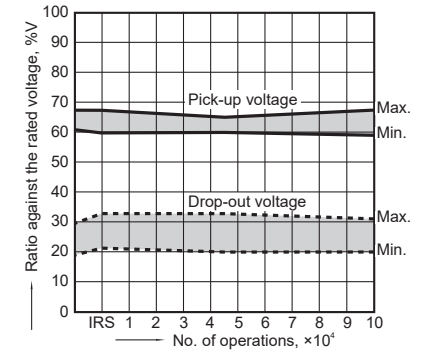

Change of contact resistance (mounting by IRS method)

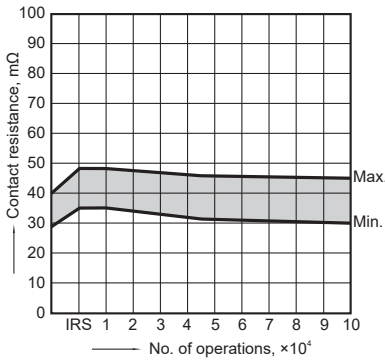

5. Coil temperature rise

Tested sample: TQ2SA-12V, 6 pcs.

Point measured: Inside the coil

Ambient temperature: 25°C 77°F



6. Operate/release time

Tested sample: TQ2SA-12V, 6 pcs.



7. Ambient temperature characteristics

Tested sample: TQ2SA-12V, 5 pcs.

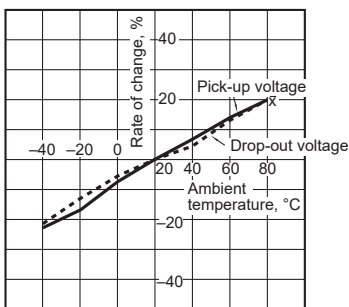

8.-(1) High-frequency characteristics (Isolation)



8.-(2) High-frequency characteristics (Insertion loss)

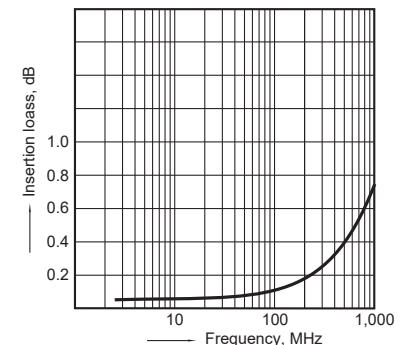

9. Malfunctional shock (single side stable)
Tested sample: TQ2SA-12V, 6 pcs



10.-(1) Influence of adjacent mounting
Tested sample: TQ2SA-12V, 5 pcs.



10.-(2) Influence of adjacent mounting
Tested sample: TQ2SA-12V, 6 pcs.



11. Pulse dialing test
(35 mA 48 V DC wire spring relay load)
Tested sample: TQ2SA-12V, 6 pcs.
Circuit



Change of pick-up and drop-out voltage
(mounting by IRS method)



Change of contact resistance
(mounting by IRS method)



DIMENSIONS (mm inch)

The CAD data of the products with a **CAD Data** mark can be downloaded from <https://industrial.panasonic.com/ac/e/>

1. Standard PC board terminal and Self-clinching terminal

CAD Data

External dimensions
Standard PC board terminal



PC board pattern (Bottom view)



Tolerance: ±0.1 ±.004

Self-clinching terminal



General tolerance: ±0.3 ±.012

Schematic (Bottom view)

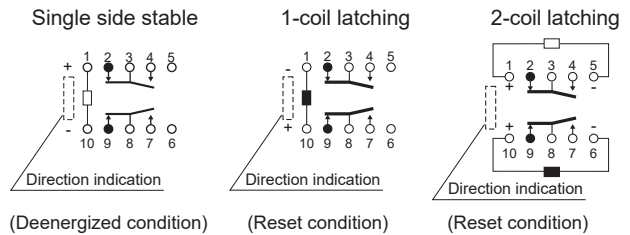

2. Surface-mount terminal

CAD Data



| Type | External dimensions(General tolerance: ± 0.3 ± 0.12) | Suggested mounting pad (Top view)(Tolerance: ± 0.1 ± 0.04) |
|---------|---|---|
| SA type | | |
| SL type | | |
| SS type | | |

Schematic (Top view)



NOTES

1. Packing style

1) The relay is packed in a tube with the relay orientation mark on the left side, as shown in the figure below.



2) Tape and reel packing (surface-mount terminal type)

(1) Tape dimensions

(i) SA type



(ii) SL, SS type



(2) Dimensions of plastic reel

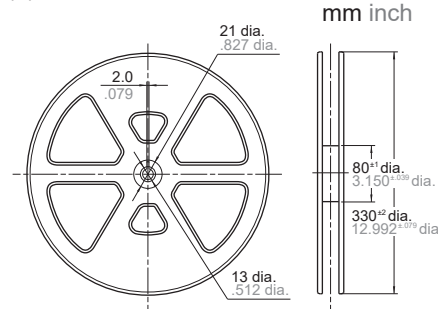

2. Automatic insertion

To maintain the internal function of the relay, the chucking pressure should not exceed the values below.

Chucking pressure in the direction A:
9.8 N {1 kgf} or less

Chucking pressure in the direction B:
9.8 N {1 kgf} or less

Chucking pressure in the direction C:
9.8 N {1 kgf} or less

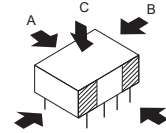

Please chuck the portion.
 Avoid chucking the center of the relay.
 In addition, excessive chucking pressure to the pinpoint of the relay should be avoided.

Ambient Environment

Usage, Transport, and Storage Conditions

During usage, storage, or transportation, avoid locations subjected to direct sunlight and maintain normal temperature, humidity and pressure conditions.

Temperature/Humidity

When transporting or storing relays while they are tube packaged, there are cases the temperature may differ from the allowable range. In this case be sure to check the individual specifications.

Also allowable humidity level is influenced by temperature, please check charts shown below and use relays within mentioned conditions. (Allowable temperature values)

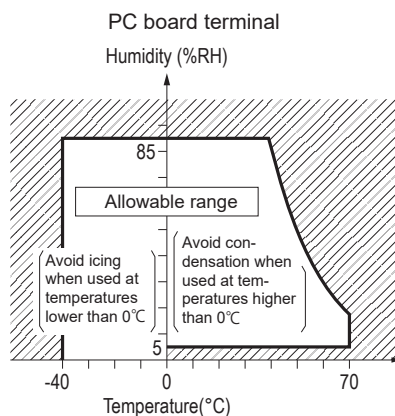
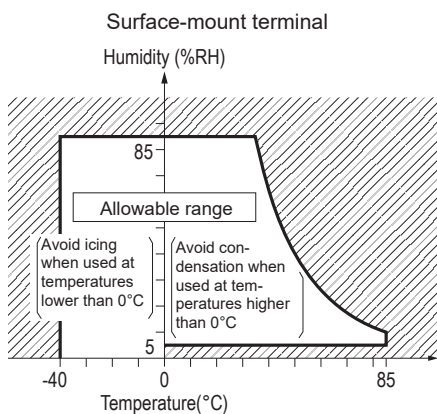

Please refer to "the latest product specifications" when designing your product.

• Requests to customers :

<https://industrial.panasonic.com/ac/e/salespolicies/>

GUIDELINES FOR RELAY USAGE

■ For cautions for use, please read "GUIDELINES FOR RELAY USAGE".

https://industrial.panasonic.com/ac/e/control/relay/cautions_use/index.jsp

PRECAUTIONS FOR COIL INPUT

■ Long term current carrying

A circuit that will be carrying a current continuously for long periods without relay switching operation. (circuits for emergency lamps, alarm devices and error inspection that, for example, revert only during malfunction and output warnings with form B contacts)

Continuous, long-term current to the coil will facilitate deterioration of coil insulation and characteristics due to heating of the coil itself. For circuits such as these, please use a magnetic-hold type latching relay. If you need to use a single stable relay, use a sealed type relay that is not easily affected by ambient conditions and make a failsafe circuit design that considers the possibility of contact failure or disconnection.

■ DC Coil operating power

Steady state DC current should be applied to the coil.

The wave form should be rectangular. If it includes ripple, the ripple factor should be less than 5%. However, please check with the actual circuit since the electrical characteristics may vary.

The rated coil voltage should be applied to the coil and the set/reset pulse time of latching type relay differs for each relays, please refer to the relay's individual specifications.

■ Coil connection

When connecting coils of polarized relays, please check coil polarity(+,-) at the internal connection diagram (Schematic). If any wrong connection is made, it may cause unexpected malfunction, like abnormal heat, fire and so on, and circuit do not work.

Avoid impressing voltages to the set coil and reset coil at the same time.

■ Maximum allowable voltage and temperature rise

Proper usage requires that the rated coil voltage be impressed on the coil.

Note, however, that if a voltage greater than or equal to the maximum continuous voltage is impressed on the coil, the coil may burn or its layers short due to the temperature rise.

Furthermore, do not exceed the usable ambient temperature range listed in the catalog.

● Temperature rise due to pulse voltage

When a pulse voltage with ON time of less than 2 minutes is used, the coil temperature rise bears no relationship to the ON time.

This varies with the ratio of ON time to OFF time, and compared with continuous current passage, it is rather small.

The various relays are essentially the same in this respect.

| Current passage time | % |
|------------------------|--------------------------------|
| For continuous passage | Temperature rise value is 100% |
| ON : OFF = 3 : 1 | About 80% |
| ON : OFF = 1 : 1 | About 50% |
| ON : OFF = 1 : 3 | About 35% |



● Operate voltage change due to coil temperature rise (hot start)

In DC relays, after continuous passage of current in the coil, if the current is turned OFF, then immediately turned ON again, due to the temperature rise in the coil, the operate voltage will become somewhat higher. Also, it will be the same as using it in a higher temperature atmosphere.

The resistance/temperature relationship for copper wire is about 0.4% for 1°C, and with this ratio the coil resistance increases.

That is, in order to operate of the relay, it is necessary that the voltage be higher than the operate voltage and the operate voltage rises in accordance with the increase in the resistance value.

However, for some polarized relays, this rate of change is considerably smaller.

NOTES

Usage, Storage, and Transport Conditions

During usage, storage, or transportation, avoid locations subject to direct sunlight and maintain normal temperature, humidity, and pressure conditions.

The allowable specifications for environments suitable for usage, storage, and transportation are given below.

1) Temperature: The allowable temperature range differs for each relay, so refer to the relay's individual specifications. In addition, when transporting or storing relays while they are tube packaged, there are cases when the temperature may differ from the allowable range. In this situation, be sure to consult the individual specifications.

2) Humidity: 5 to 85% RH

The humidity range varies with the temperature.
Use within the range indicated in the graph.
(The allowable temperature depends on the relays.)

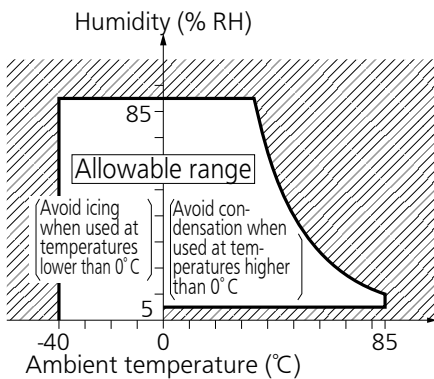

3) Pressure: 86 to 106 kPa

Condensation

Condensation occurs when the ambient temperature drops suddenly from a high temperature and humidity, or the relay and microwave device is suddenly transferred from a low ambient temperature to a high temperature and humidity.

Condensation causes the failures like insulation deterioration, wire disconnection and rust etc.

Panasonic Corporation does not guarantee the failures caused by condensation.

The heat conduction by the equipment may accelerate the cooling of device itself, and the condensation may occur.

Please conduct product evaluations in the worst condition of the actual usage. (Special attention should be paid when high temperature heating parts are close to the device. Also please consider the condensation may occur inside of the device.)

Icing

Condensation or other moisture may freeze on relays when the temperature become lower than 0°C.

This icing causes the sticking of movable portion, the operation delay and the contact conduction failure etc.

Panasonic Corporation does not guarantee the failures caused by the icing.

The heat conduction by the equipment may accelerate the cooling of relay itself and the icing may occur.

Please conduct product evaluations in the worst condition of the actual usage.

Low temperature and low humidity

The plastic becomes brittle if the switch is exposed to a low temperature, low humidity environment for long periods of time.

High temperature and high humidity

Storage for extended periods of time (including transportation periods) at high temperature or high humidity levels or in atmospheres with organic gases or sulfide gases may cause a sulfide film or oxide film to form on the surfaces of the contacts and/or it may interfere with the functions.

Check out the atmosphere in which the units are to be stored and transported.

Package

In terms of the packing format used, make every effort to keep the effects of moisture, organic gases and sulfide gases to the absolute minimum.

● Storage requirements

Since the surface-mount terminal type is sensitive to humidity it is packaged with tightly sealed anti-humidity packaging. However, when storing, please be careful of the following.

- 1) Please use promptly once the anti-humidity pack is opened. (within 72 hours, Max. 30°C / 70% RH).
If left with the pack open, the relay will absorb moisture which will cause thermal stress when reflow mounting and thus cause the case to expand. As a result, the seal may break.
- 2) If relays will not be used within 72 hours, please store relays in a humidity controlled desiccator or in an anti-humidity bag to which silica gel has been added.
* If the relay is to be soldered after it has been exposed to excessive humidity atmosphere, cracks and leaks can occur.
Be sure to mount the relay under the required mounting conditions.
- 3) When relays (which is packaged with humidity indicator and silica gel) meeting one of below criteria, please bake (dry) before use.
 - When the storage conditions specified in 1) are exceeded.
 - When humidity indicator is in III or IV status according to judgement standard.

<How to judge>

Please check humidity indicator color and decide if baking is necessary or not.

● : indicate brown, ○ : Other than brown (blueish color)

| | 5% | 10% | 60% | Bake treatment necessity judgment |
|-----|----|-----|-----|-----------------------------------|
| I | ● | ● | ● | No need to bake |
| II | ○ | ● | ● | No need to bake |
| III | ○ | ○ | ● | Need to bake |
| IV | ○ | ○ | ○ | Need to bake |

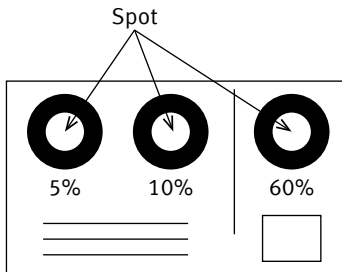

Humidity indicator card

<Baking (Drying) conditions>

- With reel : 45°C, 96 hours or more.



- Without reel (including relay only) : 60°C, 35 hours or more.



- 4) The following cautionary label is affixed to the anti-humidity pack.

C a u t i o n

This vacuum-sealed bag contains

Moisture Sensitive Products

After this bag is opened, the product must be used

within 7 2 h o u r s

If product is not used within 72 hours, baking is necessary.

For baking conditions please contact us.

● Silicon

When a source of silicone substances (silicone rubber, silicone oil, silicone coating materials and silicone filling materials etc.) is used around the relay, the silicone gas (low molecular siloxane etc.) may be produced

This silicone gas may penetrate into the inside of the relay. When the relay is kept and used in this condition, silicone compound may adhere to the relay contacts which may cause the contact failure.

Do not use any sources of silicone gas around the relay (Including plastic seal types).

● NOx Generation

When relay is used in an atmosphere high in humidity to switch a load which easily produces an arc, the NOx created by the arc and the water absorbed from outside the relay combine to produce nitric acid.

This corrodes the internal metal parts and adversely affects operation.

Avoid use at an ambient humidity of 85% RH or higher (at 20°C).

If use at high humidity is unavoidable, please contact our sales representative.

OTHERS

■Cleaning

- 1) Although the environmentally sealed type relay (plastic sealed type, etc.) can be cleaned, avoid immersing the relay into cold liquid (such as cleaning solvent) immediately after soldering. Doing so may deteriorate the sealing performance.
- 2) Surface-mount terminal type relay is sealed type and it can be cleaned by immersion.
Use pure water or alcohol-based cleaning solvent.
- 3) Cleaning with the boiling method is recommended (The temperature of cleaning liquid should be 40°C or lower). Avoid ultrasonic cleaning on relays.
Use of ultrasonic cleaning may cause breaks in the coil or slight sticking of the contacts due to the ultrasonic energy.

Please refer to **"the latest product specifications"** when designing your product.

•Requests to customers:

<https://industrial.panasonic.com/ac/e/salespolicies/>

Please contact

Panasonic Corporation

Electromechanical Control Business Division

■ 1006, Oaza Kadoma, Kadoma-shi, Osaka 571-8506, Japan
industrial.panasonic.com/ac/e/

Panasonic[®]

©Panasonic Corporation 2019