

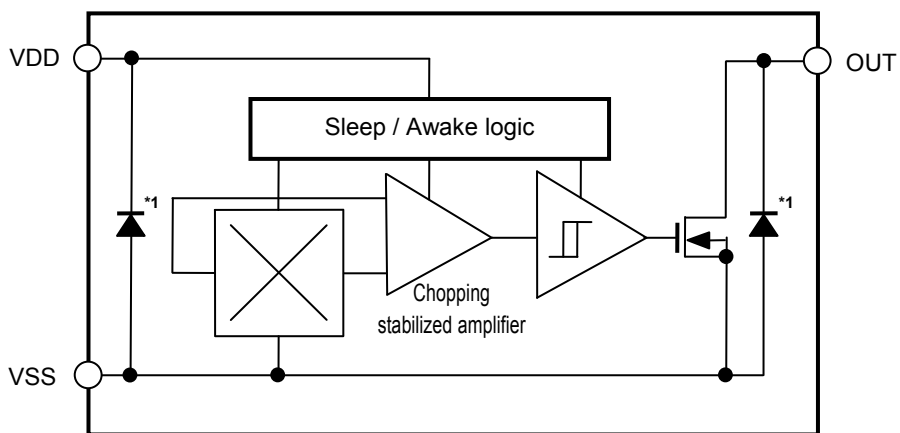

■ Block Diagrams

1. Nch open-drain output product



\*1. Parasitic diode

Figure 1

2. CMOS output product

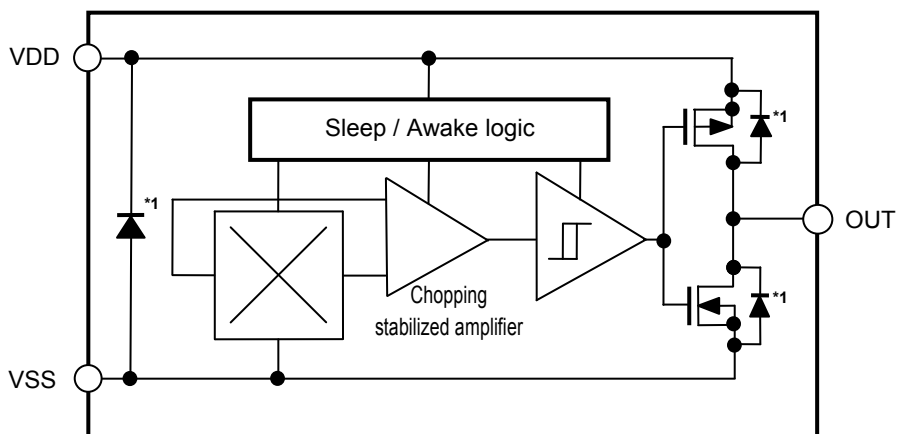

\*1. Parasitic diode

Figure 2

■ Product Name Structure

1. Product name

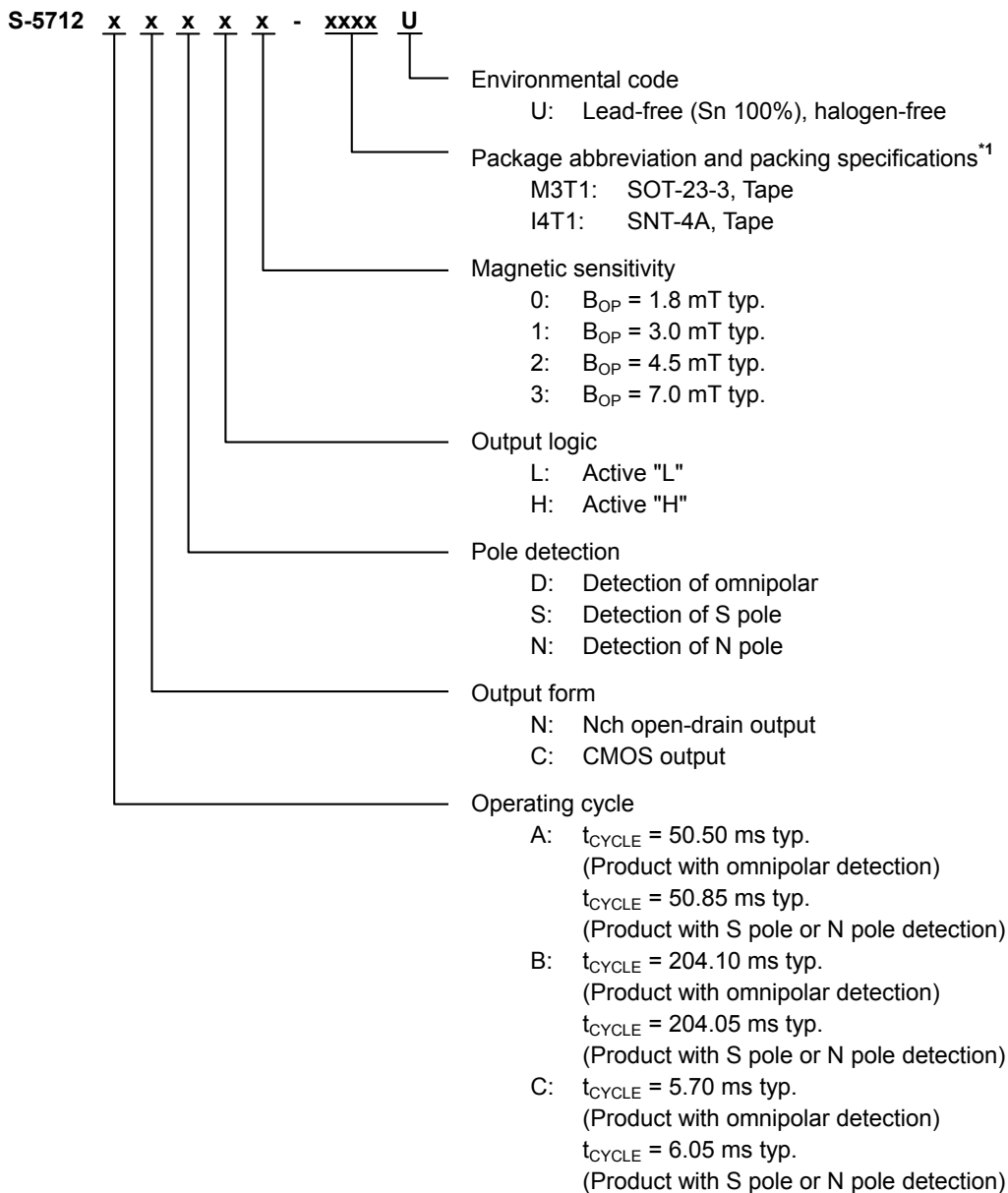

\*1. Refer to the tape drawing.

2. Packages

Table 1 Package Drawing Codes

Package Name	Dimension	Tape	Reel	Land
SOT-23-3	MP003-C-P-SD	MP003-C-C-SD	MP003-Z-R-SD	-
SNT-4A	PF004-A-P-SD	PF004-A-C-SD	PF004-A-R-SD	PF004-A-L-SD

**3. Product name list**

**3.1 SOT-23-3**

**3.1.1 Nch open-drain output product**

**Table 2**

Product Name	Operating Cycle ( $t_{CYCLE}$ )	Output Form	Pole Detection	Output Logic	Magnetic Sensitivity ( $B_{OP}$ )
S-5712ANDL0-M3T1U	50.50 ms typ.	Nch open-drain output	Omnipolar	Active "L"	1.8 mT typ.
S-5712ANDL1-M3T1U	50.50 ms typ.	Nch open-drain output	Omnipolar	Active "L"	3.0 mT typ.
S-5712ANDL2-M3T1U	50.50 ms typ.	Nch open-drain output	Omnipolar	Active "L"	4.5 mT typ.
S-5712ANSL1-M3T1U	50.85 ms typ.	Nch open-drain output	S pole	Active "L"	3.0 mT typ.
S-5712ANSL2-M3T1U	50.85 ms typ.	Nch open-drain output	S pole	Active "L"	4.5 mT typ.
S-5712ANSH1-M3T1U	50.85 ms typ.	Nch open-drain output	S pole	Active "H"	3.0 mT typ.
S-5712BNDL2-M3T1U	204.10 ms typ.	Nch open-drain output	Omnipolar	Active "L"	4.5 mT typ.
S-5712BNDH2-M3T1U	204.10 ms typ.	Nch open-drain output	Omnipolar	Active "H"	4.5 mT typ.

**Remark** Please contact our sales office for products other than the above.

**3.1.2 CMOS output product**

**Table 3**

Product Name	Operating Cycle ( $t_{CYCLE}$ )	Output Form	Pole Detection	Output Logic	Magnetic Sensitivity ( $B_{OP}$ )
S-5712ACDL1-M3T1U	50.50 ms typ.	CMOS output	Omnipolar	Active "L"	3.0 mT typ.
S-5712ACDL2-M3T1U	50.50 ms typ.	CMOS output	Omnipolar	Active "L"	4.5 mT typ.
S-5712ACDH1-M3T1U	50.50 ms typ.	CMOS output	Omnipolar	Active "H"	3.0 mT typ.
S-5712ACDH2-M3T1U	50.50 ms typ.	CMOS output	Omnipolar	Active "H"	4.5 mT typ.
S-5712ACSL1-M3T1U	50.85 ms typ.	CMOS output	S pole	Active "L"	3.0 mT typ.
S-5712ACSL2-M3T1U	50.85 ms typ.	CMOS output	S pole	Active "L"	4.5 mT typ.
S-5712ACNL1-M3T1U	50.85 ms typ.	CMOS output	N pole	Active "L"	3.0 mT typ.
S-5712ACNL2-M3T1U	50.85 ms typ.	CMOS output	N pole	Active "L"	4.5 mT typ.
S-5712CCDL1-M3T1U	5.70 ms typ.	CMOS output	Omnipolar	Active "L"	3.0 mT typ.
S-5712CCSL1-M3T1U	6.05 ms typ.	CMOS output	S pole	Active "L"	3.0 mT typ.

**Remark** Please contact our sales office for products other than the above.

**3.2 SNT-4A**

**3.2.1 Nch open-drain output product**

**Table 4**

Product Name	Operating Cycle ( $t_{CYCLE}$ )	Output Form	Pole Detection	Output Logic	Magnetic Sensitivity ( $B_{OP}$ )
S-5712ANDL0-I4T1U	50.50 ms typ.	Nch open-drain output	Omnipolar	Active "L"	1.8 mT typ.
S-5712ANDL1-I4T1U	50.50 ms typ.	Nch open-drain output	Omnipolar	Active "L"	3.0 mT typ.
S-5712ANDL2-I4T1U	50.50 ms typ.	Nch open-drain output	Omnipolar	Active "L"	4.5 mT typ.
S-5712ANSL1-I4T1U	50.85 ms typ.	Nch open-drain output	S pole	Active "L"	3.0 mT typ.
S-5712ANSL2-I4T1U	50.85 ms typ.	Nch open-drain output	S pole	Active "L"	4.5 mT typ.
S-5712BNDL2-I4T1U	204.10 ms typ.	Nch open-drain output	Omnipolar	Active "L"	4.5 mT typ.
S-5712BNDH2-I4T1U	204.10 ms typ.	Nch open-drain output	Omnipolar	Active "H"	4.5 mT typ.

**Remark** Please contact our sales office for products other than the above.

**3.2.2 CMOS output product**

**Table 5**

Product Name	Operating Cycle ( $t_{CYCLE}$ )	Output Form	Pole Detection	Output Logic	Magnetic Sensitivity ( $B_{OP}$ )
S-5712ACDL0-I4T1U	50.50 ms typ.	CMOS output	Omnipolar	Active "L"	1.8 mT typ.
S-5712ACDL1-I4T1U	50.50 ms typ.	CMOS output	Omnipolar	Active "L"	3.0 mT typ.
S-5712ACDL2-I4T1U	50.50 ms typ.	CMOS output	Omnipolar	Active "L"	4.5 mT typ.
S-5712ACDL3-I4T1U	50.50 ms typ.	CMOS output	Omnipolar	Active "L"	7.0 mT typ.
S-5712ACDH1-I4T1U	50.50 ms typ.	CMOS output	Omnipolar	Active "H"	3.0 mT typ.
S-5712ACDH2-I4T1U	50.50 ms typ.	CMOS output	Omnipolar	Active "H"	4.5 mT typ.
S-5712ACSL1-I4T1U	50.85 ms typ.	CMOS output	S pole	Active "L"	3.0 mT typ.
S-5712ACSL2-I4T1U	50.85 ms typ.	CMOS output	S pole	Active "L"	4.5 mT typ.
S-5712ACSH1-I4T1U	50.85 ms typ.	CMOS output	S pole	Active "H"	3.0 mT typ.
S-5712ACSH2-I4T1U	50.85 ms typ.	CMOS output	S pole	Active "H"	4.5 mT typ.
S-5712ACNL1-I4T1U	50.85 ms typ.	CMOS output	N pole	Active "L"	3.0 mT typ.
S-5712ACNL2-I4T1U	50.85 ms typ.	CMOS output	N pole	Active "L"	4.5 mT typ.
S-5712ACNL3-I4T1U	50.85 ms typ.	CMOS output	N pole	Active "L"	7.0 mT typ.
S-5712ACNH1-I4T1U	50.85 ms typ.	CMOS output	N pole	Active "H"	3.0 mT typ.
S-5712BCDL1-I4T1U	204.10 ms typ.	CMOS output	Omnipolar	Active "L"	3.0 mT typ.
S-5712BCDL2-I4T1U	204.10 ms typ.	CMOS output	Omnipolar	Active "L"	4.5 mT typ.
S-5712BCDH1-I4T1U	204.10 ms typ.	CMOS output	Omnipolar	Active "H"	3.0 mT typ.
S-5712BCDH2-I4T1U	204.10 ms typ.	CMOS output	Omnipolar	Active "H"	4.5 mT typ.
S-5712BCSL2-I4T1U	204.05 ms typ.	CMOS output	S pole	Active "L"	4.5 mT typ.
S-5712CCDL1-I4T1U	5.70 ms typ.	CMOS output	Omnipolar	Active "L"	3.0 mT typ.
S-5712CCDH1-I4T1U	5.70 ms typ.	CMOS output	Omnipolar	Active "H"	3.0 mT typ.
S-5712CCSL1-I4T1U	6.05 ms typ.	CMOS output	S pole	Active "L"	3.0 mT typ.
S-5712CCNL1-I4T1U	6.05 ms typ.	CMOS output	N pole	Active "L"	3.0 mT typ.

**Remark** Please contact our sales office for products other than the above.

■ Pin Configurations

1. SOT-23-3

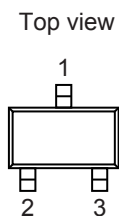

Figure 3

Table 6

Pin No.	Symbol	Pin Description
1	VSS	GND pin
2	VDD	Power supply pin
3	OUT	Output pin

2. SNT-4A

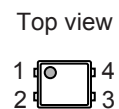

Figure 4

Table 7

Pin No.	Symbol	Pin Description
1	VDD	Power supply pin
2	VSS	GND pin
3	NC*1	No connection
4	OUT	Output pin

\*1. The NC pin is electrically open.  
 The NC pin can be connected to the VDD pin or the VSS pin.

■ Absolute Maximum Ratings

Table 8

(Ta = +25°C unless otherwise specified)

Item	Symbol	Absolute Maximum Rating	Unit
Power supply voltage	V <sub>DD</sub>	V <sub>SS</sub> - 0.3 to V <sub>SS</sub> + 7.0	V
Output current	I <sub>OUT</sub>	±1.0	mA
Output voltage	Nch open-drain output product	V <sub>OUT</sub>	V <sub>SS</sub> - 0.3 to V <sub>SS</sub> + 7.0
	CMOS output product		V <sub>SS</sub> - 0.3 to V <sub>DD</sub> + 0.3
Operation ambient temperature	T <sub>opr</sub>	-40 to +85	°C
Storage temperature	T <sub>stg</sub>	-40 to +125	°C

**Caution** The absolute maximum ratings are rated values exceeding which the product could suffer physical damage. These values must therefore not be exceeded under any conditions.

■ Thermal Resistance Value

Table 9

Item	Symbol	Condition	Min.	Typ.	Max.	Unit	
Junction-to-ambient thermal resistance *1	θ <sub>JA</sub>	SOT-23-3	Board A	-	200	-	°C/W
			Board B	-	165	-	°C/W
			Board C	-	-	-	°C/W
			Board D	-	-	-	°C/W
			Board E	-	-	-	°C/W
		SNT-4A	Board A	-	300	-	°C/W
			Board B	-	242	-	°C/W
			Board C	-	-	-	°C/W
			Board D	-	-	-	°C/W
			Board E	-	-	-	°C/W

\*1. Test environment: compliance with JEDEC STANDARD JESD51-2A

**Remark** Refer to "■ Power Dissipation" and "Test Board" for details.

■ Electrical Characteristics

1. Product with omnipolar detection

1.1 S-5712AxDxx

Table 10

(Ta = +25°C, V<sub>DD</sub> = 1.85 V, V<sub>SS</sub> = 0 V unless otherwise specified)

Item	Symbol	Condition		Min.	Typ.	Max.	Unit	Test Circuit
Power supply voltage	V <sub>DD</sub>	-		1.60	1.85	3.50	V	-
Current consumption	I <sub>DD</sub>	Average value		-	2.0	4.0	μA	1
Output voltage	V <sub>OUT</sub>	Nch open-drain output product	Output transistor Nch, I <sub>OUT</sub> = 0.5 mA	-	-	0.4	V	2
		CMOS output product	Output transistor Nch, I <sub>OUT</sub> = 0.5 mA	-	-	0.4	V	2
			Output transistor Pch, I <sub>OUT</sub> = -0.5 mA	V <sub>DD</sub> - 0.4	-	-	V	3
Leakage current	I <sub>LEAK</sub>	Nch open-drain output product Output transistor Nch, V <sub>OUT</sub> = 3.5 V		-	-	1	μA	4
Awake mode time	t <sub>AW</sub>	-		-	0.10	-	ms	-
Sleep mode time	t <sub>SL</sub>	-		-	50.40	-	ms	-
Operating cycle	t <sub>CYCLE</sub>	t <sub>AW</sub> + t <sub>SL</sub>		-	50.50	100.00	ms	-

1.2 S-5712BxDxx

Table 11

(Ta = +25°C, V<sub>DD</sub> = 1.85 V, V<sub>SS</sub> = 0 V unless otherwise specified)

Item	Symbol	Condition		Min.	Typ.	Max.	Unit	Test Circuit
Power supply voltage	V <sub>DD</sub>	-		1.60	1.85	3.50	V	-
Current consumption	I <sub>DD</sub>	Average value		-	1.0	2.0	μA	1
Output voltage	V <sub>OUT</sub>	Nch open-drain output product	Output transistor Nch, I <sub>OUT</sub> = 0.5 mA	-	-	0.4	V	2
		CMOS output product	Output transistor Nch, I <sub>OUT</sub> = 0.5 mA	-	-	0.4	V	2
			Output transistor Pch, I <sub>OUT</sub> = -0.5 mA	V <sub>DD</sub> - 0.4	-	-	V	3
Leakage current	I <sub>LEAK</sub>	Nch open-drain output product Output transistor Nch, V <sub>OUT</sub> = 3.5 V		-	-	1	μA	4
Awake mode time	t <sub>AW</sub>	-		-	0.10	-	ms	-
Sleep mode time	t <sub>SL</sub>	-		-	204.00	-	ms	-
Operating cycle	t <sub>CYCLE</sub>	t <sub>AW</sub> + t <sub>SL</sub>		-	204.10	400.00	ms	-



1.3 S-5712CxDxx

Table 12

(Ta = +25°C, V<sub>DD</sub> = 1.85 V, V<sub>SS</sub> = 0 V unless otherwise specified)

Item	Symbol	Condition	Min.	Typ.	Max.	Unit	Test Circuit	
Power supply voltage	V <sub>DD</sub>	–	1.60	1.85	3.50	V	–	
Current consumption	I <sub>DD</sub>	Average value	–	12.0	22.0	μA	1	
Output voltage	V <sub>OUT</sub>	Nch open-drain output product	Output transistor Nch, I <sub>OUT</sub> = 0.5 mA	–	–	0.4	V	2
		CMOS output product	Output transistor Nch, I <sub>OUT</sub> = 0.5 mA	–	–	0.4	V	2
			Output transistor Pch, I <sub>OUT</sub> = –0.5 mA	V <sub>DD</sub> – 0.4	–	–	V	3
Leakage current	I <sub>LEAK</sub>	Nch open-drain output product Output transistor Nch, V <sub>OUT</sub> = 3.5 V	–	–	1	μA	4	
Awake mode time	t <sub>AW</sub>	–	–	0.10	–	ms	–	
Sleep mode time	t <sub>SL</sub>	–	–	5.60	–	ms	–	
Operating cycle	t <sub>CYCLE</sub>	t <sub>AW</sub> + t <sub>SL</sub>	–	5.70	12.00	ms	–	

2. Product with S pole or N pole detection

2.1 S-5712AxSxx, S-5712AxNxx

Table 13

(Ta = +25°C, V<sub>DD</sub> = 1.85 V, V<sub>SS</sub> = 0 V unless otherwise specified)

Item	Symbol	Condition	Min.	Typ.	Max.	Unit	Test Circuit	
Power supply voltage	V <sub>DD</sub>	–	1.60	1.85	3.50	V	–	
Current consumption	I <sub>DD</sub>	Average value	–	1.4	3.0	μA	1	
Output voltage	V <sub>OUT</sub>	Nch open-drain output product	Output transistor Nch, I <sub>OUT</sub> = 0.5 mA	–	–	0.4	V	2
		CMOS output product	Output transistor Nch, I <sub>OUT</sub> = 0.5 mA	–	–	0.4	V	2
			Output transistor Pch, I <sub>OUT</sub> = –0.5 mA	V <sub>DD</sub> – 0.4	–	–	V	3
Leakage current	I <sub>LEAK</sub>	Nch open-drain output product Output transistor Nch, V <sub>OUT</sub> = 3.5 V	–	–	1	μA	4	
Awake mode time	t <sub>AW</sub>	–	–	0.05	–	ms	–	
Sleep mode time	t <sub>SL</sub>	–	–	50.80	–	ms	–	
Operating cycle	t <sub>CYCLE</sub>	t <sub>AW</sub> + t <sub>SL</sub>	–	50.85	100.00	ms	–	

**2.2 S-5712BxSxx, S-5712BxNxx**

**Table 14**

(Ta = +25°C, V<sub>DD</sub> = 1.85 V, V<sub>SS</sub> = 0 V unless otherwise specified)

Item	Symbol	Condition	Min.	Typ.	Max.	Unit	Test Circuit	
Power supply voltage	V <sub>DD</sub>	–	1.60	1.85	3.50	V	–	
Current consumption	I <sub>DD</sub>	Average value	–	1.0	2.0	μA	1	
Output voltage	V <sub>OUT</sub>	Nch open-drain output product	Output transistor Nch, I <sub>OUT</sub> = 0.5 mA	–	–	0.4	V	2
		CMOS output product	Output transistor Nch, I <sub>OUT</sub> = 0.5 mA	–	–	0.4	V	2
			Output transistor Pch, I <sub>OUT</sub> = –0.5 mA	V <sub>DD</sub> – 0.4	–	–	V	3
Leakage current	I <sub>LEAK</sub>	Nch open-drain output product Output transistor Nch, V <sub>OUT</sub> = 3.5 V	–	–	1	μA	4	
Awake mode time	t <sub>AW</sub>	–	–	0.05	–	ms	–	
Sleep mode time	t <sub>SL</sub>	–	–	204.00	–	ms	–	
Operating cycle	t <sub>CYCLE</sub>	t <sub>AW</sub> + t <sub>SL</sub>	–	204.05	400.00	ms	–	

**2.3 S-5712CxSxx, S-5712CxNxx**

**Table 15**

(Ta = +25°C, V<sub>DD</sub> = 1.85 V, V<sub>SS</sub> = 0 V unless otherwise specified)

Item	Symbol	Condition	Min.	Typ.	Max.	Unit	Test Circuit	
Power supply voltage	V <sub>DD</sub>	–	1.60	1.85	3.50	V	–	
Current consumption	I <sub>DD</sub>	Average value	–	6.0	11.0	μA	1	
Output voltage	V <sub>OUT</sub>	Nch open-drain output product	Output transistor Nch, I <sub>OUT</sub> = 0.5 mA	–	–	0.4	V	2
		CMOS output product	Output transistor Nch, I <sub>OUT</sub> = 0.5 mA	–	–	0.4	V	2
			Output transistor Pch, I <sub>OUT</sub> = –0.5 mA	V <sub>DD</sub> – 0.4	–	–	V	3
Leakage current	I <sub>LEAK</sub>	Nch open-drain output product Output transistor Nch, V <sub>OUT</sub> = 3.5 V	–	–	1	μA	4	
Awake mode time	t <sub>AW</sub>	–	–	0.05	–	ms	–	
Sleep mode time	t <sub>SL</sub>	–	–	6.00	–	ms	–	
Operating cycle	t <sub>CYCLE</sub>	t <sub>AW</sub> + t <sub>SL</sub>	–	6.05	12.00	ms	–	

■ **Magnetic Characteristics**

1. **Product with omnipolar detection**

1.1 **Product with  $B_{OP} = 1.8 \text{ mT typ.}$**

**Table 16**

( $T_a = +25^\circ\text{C}$ ,  $V_{DD} = 1.85 \text{ V}$ ,  $V_{SS} = 0 \text{ V}$  unless otherwise specified)

Item	Symbol	Condition	Min.	Typ.	Max.	Unit	Test Circuit	
Operation point* <sup>1</sup>	S pole	$B_{OPS}$	–	0.6	1.8	3.0	mT	5
	N pole	$B_{OPN}$	–	–3.0	–1.8	–0.6	mT	5
Release point* <sup>2</sup>	S pole	$B_{RPS}$	–	0.1	1.1	2.4	mT	5
	N pole	$B_{RPN}$	–	–2.4	–1.1	–0.1	mT	5
Hysteresis width* <sup>3</sup>	S pole	$B_{HYSS}$	$B_{HYSS} = B_{OPS} - B_{RPS}$	–	0.7	–	mT	5
	N pole	$B_{HYSN}$	$B_{HYSN} =  B_{OPN} - B_{RPN} $	–	0.7	–	mT	5

1.2 **Product with  $B_{OP} = 3.0 \text{ mT typ.}$**

**Table 17**

( $T_a = +25^\circ\text{C}$ ,  $V_{DD} = 1.85 \text{ V}$ ,  $V_{SS} = 0 \text{ V}$  unless otherwise specified)

Item	Symbol	Condition	Min.	Typ.	Max.	Unit	Test Circuit	
Operation point* <sup>1</sup>	S pole	$B_{OPS}$	–	1.4	3.0	4.0	mT	5
	N pole	$B_{OPN}$	–	–4.0	–3.0	–1.4	mT	5
Release point* <sup>2</sup>	S pole	$B_{RPS}$	–	1.1	2.2	3.7	mT	5
	N pole	$B_{RPN}$	–	–3.7	–2.2	–1.1	mT	5
Hysteresis width* <sup>3</sup>	S pole	$B_{HYSS}$	$B_{HYSS} = B_{OPS} - B_{RPS}$	–	0.8	–	mT	5
	N pole	$B_{HYSN}$	$B_{HYSN} =  B_{OPN} - B_{RPN} $	–	0.8	–	mT	5

1.3 **Product with  $B_{OP} = 4.5 \text{ mT typ.}$**

**Table 18**

( $T_a = +25^\circ\text{C}$ ,  $V_{DD} = 1.85 \text{ V}$ ,  $V_{SS} = 0 \text{ V}$  unless otherwise specified)

Item	Symbol	Condition	Min.	Typ.	Max.	Unit	Test Circuit	
Operation point* <sup>1</sup>	S pole	$B_{OPS}$	–	2.5	4.5	6.0	mT	5
	N pole	$B_{OPN}$	–	–6.0	–4.5	–2.5	mT	5
Release point* <sup>2</sup>	S pole	$B_{RPS}$	–	2.0	3.5	5.5	mT	5
	N pole	$B_{RPN}$	–	–5.5	–3.5	–2.0	mT	5
Hysteresis width* <sup>3</sup>	S pole	$B_{HYSS}$	$B_{HYSS} = B_{OPS} - B_{RPS}$	–	1.0	–	mT	5
	N pole	$B_{HYSN}$	$B_{HYSN} =  B_{OPN} - B_{RPN} $	–	1.0	–	mT	5

1.4 **Product with  $B_{OP} = 7.0 \text{ mT typ.}$**

**Table 19**

( $T_a = +25^\circ\text{C}$ ,  $V_{DD} = 1.85 \text{ V}$ ,  $V_{SS} = 0 \text{ V}$  unless otherwise specified)

Item	Symbol	Condition	Min.	Typ.	Max.	Unit	Test Circuit	
Operation point* <sup>1</sup>	S pole	$B_{OPS}$	–	5.0	7.0	8.5	mT	5
	N pole	$B_{OPN}$	–	–8.5	–7.0	–5.0	mT	5
Release point* <sup>2</sup>	S pole	$B_{RPS}$	–	3.7	5.2	7.2	mT	5
	N pole	$B_{RPN}$	–	–7.2	–5.2	–3.7	mT	5
Hysteresis width* <sup>3</sup>	S pole	$B_{HYSS}$	$B_{HYSS} = B_{OPS} - B_{RPS}$	–	1.8	–	mT	5
	N pole	$B_{HYSN}$	$B_{HYSN} =  B_{OPN} - B_{RPN} $	–	1.8	–	mT	5

**2. Product with S pole detection**

**2.1 Product with  $B_{OP} = 1.8$  mT typ.**

**Table 20**

( $T_a = +25^\circ\text{C}$ ,  $V_{DD} = 1.85$  V,  $V_{SS} = 0$  V unless otherwise specified)

Item		Symbol	Condition	Min.	Typ.	Max.	Unit	Test Circuit
Operation point <sup>*1</sup>	S pole	$B_{OPS}$	–	0.6	1.8	3.0	mT	5
Release point <sup>*2</sup>	S pole	$B_{RPS}$	–	0.1	1.1	2.4	mT	5
Hysteresis width <sup>*3</sup>	S pole	$B_{HYSS}$	$B_{HYSS} = B_{OPS} - B_{RPS}$	–	0.7	–	mT	5

**2.2 Product with  $B_{OP} = 3.0$  mT typ.**

**Table 21**

( $T_a = +25^\circ\text{C}$ ,  $V_{DD} = 1.85$  V,  $V_{SS} = 0$  V unless otherwise specified)

Item		Symbol	Condition	Min.	Typ.	Max.	Unit	Test Circuit
Operation point <sup>*1</sup>	S pole	$B_{OPS}$	–	1.4	3.0	4.0	mT	5
Release point <sup>*2</sup>	S pole	$B_{RPS}$	–	1.1	2.2	3.7	mT	5
Hysteresis width <sup>*3</sup>	S pole	$B_{HYSS}$	$B_{HYSS} = B_{OPS} - B_{RPS}$	–	0.8	–	mT	5

**2.3 Product with  $B_{OP} = 4.5$  mT typ.**

**Table 22**

( $T_a = +25^\circ\text{C}$ ,  $V_{DD} = 1.85$  V,  $V_{SS} = 0$  V unless otherwise specified)

Item		Symbol	Condition	Min.	Typ.	Max.	Unit	Test Circuit
Operation point <sup>*1</sup>	S pole	$B_{OPS}$	–	2.5	4.5	6.0	mT	5
Release point <sup>*2</sup>	S pole	$B_{RPS}$	–	2.0	3.5	5.5	mT	5
Hysteresis width <sup>*3</sup>	S pole	$B_{HYSS}$	$B_{HYSS} = B_{OPS} - B_{RPS}$	–	1.0	–	mT	5

**2.4 Product with  $B_{OP} = 7.0$  mT typ.**

**Table 23**

( $T_a = +25^\circ\text{C}$ ,  $V_{DD} = 1.85$  V,  $V_{SS} = 0$  V unless otherwise specified)

Item		Symbol	Condition	Min.	Typ.	Max.	Unit	Test Circuit
Operation point <sup>*1</sup>	S pole	$B_{OPS}$	–	5.0	7.0	8.5	mT	5
Release point <sup>*2</sup>	S pole	$B_{RPS}$	–	3.7	5.2	7.2	mT	5
Hysteresis width <sup>*3</sup>	S pole	$B_{HYSS}$	$B_{HYSS} = B_{OPS} - B_{RPS}$	–	1.8	–	mT	5

### 3. Product with N pole detection

#### 3.1 Product with $B_{OP} = 1.8 \text{ mT typ.}$

**Table 24**

( $T_a = +25^\circ\text{C}$ ,  $V_{DD} = 1.85 \text{ V}$ ,  $V_{SS} = 0 \text{ V}$  unless otherwise specified)

Item		Symbol	Condition	Min.	Typ.	Max.	Unit	Test Circuit
Operation point <sup>*1</sup>	N pole	$B_{OPN}$	–	–3.0	–1.8	–0.6	mT	5
Release point <sup>*2</sup>	N pole	$B_{RPN}$	–	–2.4	–1.1	–0.1	mT	5
Hysteresis width <sup>*3</sup>	N pole	$B_{HYSN}$	$B_{HYSN} =  B_{OPN} - B_{RPN} $	–	0.7	–	mT	5

#### 3.2 Product with $B_{OP} = 3.0 \text{ mT typ.}$

**Table 25**

( $T_a = +25^\circ\text{C}$ ,  $V_{DD} = 1.85 \text{ V}$ ,  $V_{SS} = 0 \text{ V}$  unless otherwise specified)

Item		Symbol	Condition	Min.	Typ.	Max.	Unit	Test Circuit
Operation point <sup>*1</sup>	N pole	$B_{OPN}$	–	–4.0	–3.0	–1.4	mT	5
Release point <sup>*2</sup>	N pole	$B_{RPN}$	–	–3.7	–2.2	–1.1	mT	5
Hysteresis width <sup>*3</sup>	N pole	$B_{HYSN}$	$B_{HYSN} =  B_{OPN} - B_{RPN} $	–	0.8	–	mT	5

#### 3.3 Product with $B_{OP} = 4.5 \text{ mT typ.}$

**Table 26**

( $T_a = +25^\circ\text{C}$ ,  $V_{DD} = 1.85 \text{ V}$ ,  $V_{SS} = 0 \text{ V}$  unless otherwise specified)

Item		Symbol	Condition	Min.	Typ.	Max.	Unit	Test Circuit
Operation point <sup>*1</sup>	N pole	$B_{OPN}$	–	–6.0	–4.5	–2.5	mT	5
Release point <sup>*2</sup>	N pole	$B_{RPN}$	–	–5.5	–3.5	–2.0	mT	5
Hysteresis width <sup>*3</sup>	N pole	$B_{HYSN}$	$B_{HYSN} =  B_{OPN} - B_{RPN} $	–	1.0	–	mT	5

#### 3.4 Product with $B_{OP} = 7.0 \text{ mT typ.}$

**Table 27**

( $T_a = +25^\circ\text{C}$ ,  $V_{DD} = 1.85 \text{ V}$ ,  $V_{SS} = 0 \text{ V}$  unless otherwise specified)

Item		Symbol	Condition	Min.	Typ.	Max.	Unit	Test Circuit
Operation point <sup>*1</sup>	N pole	$B_{OPN}$	–	–8.5	–7.0	–5.0	mT	5
Release point <sup>*2</sup>	N pole	$B_{RPN}$	–	–7.2	–5.2	–3.7	mT	5
Hysteresis width <sup>*3</sup>	N pole	$B_{HYSN}$	$B_{HYSN} =  B_{OPN} - B_{RPN} $	–	1.8	–	mT	5

**\*1.**  $B_{OPN}$ ,  $B_{OPS}$ : Operation points

$B_{OPN}$  and  $B_{OPS}$  are the values of magnetic flux density when the output voltage ( $V_{OUT}$ ) changes after the magnetic flux density applied to this IC by the magnet (N pole or S pole) is increased (by moving the magnet closer). Even when the magnetic flux density exceeds  $B_{OPN}$  or  $B_{OPS}$ ,  $V_{OUT}$  retains the status.

**\*2.**  $B_{RPN}$ ,  $B_{RPS}$ : Release points

$B_{RPN}$  and  $B_{RPS}$  are the values of magnetic flux density when the output voltage ( $V_{OUT}$ ) changes after the magnetic flux density applied to this IC by the magnet (N pole or S pole) is decreased (the magnet is moved further away). Even when the magnetic flux density falls below  $B_{RPN}$  or  $B_{RPS}$ ,  $V_{OUT}$  retains the status.

**\*3.**  $B_{HYSN}$ ,  $B_{HYSS}$ : Hysteresis widths

$B_{HYSN}$  and  $B_{HYSS}$  are the difference between  $B_{OPN}$  and  $B_{RPN}$ , and  $B_{OPS}$  and  $B_{RPS}$ , respectively.

**Remark** The unit of magnetic density mT can be converted by using the formula  $1 \text{ mT} = 10 \text{ Gauss}$ .

■ Test Circuits

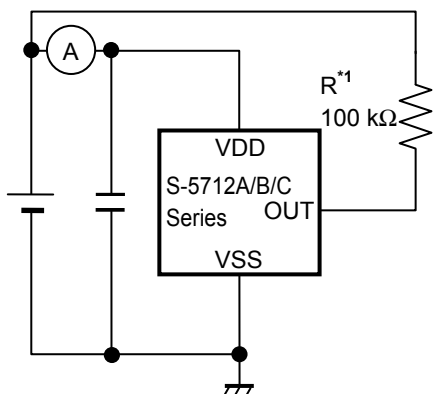

\*1. Resistor (R) is unnecessary for the CMOS output product.

Figure 5 Test Circuit 1

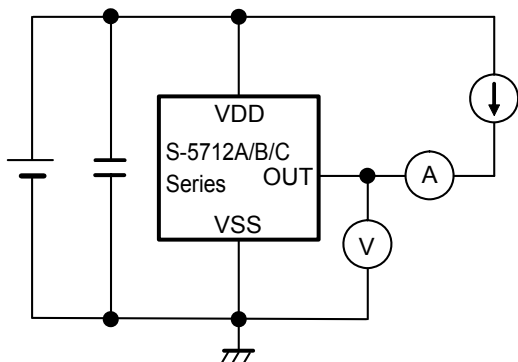

Figure 6 Test Circuit 2

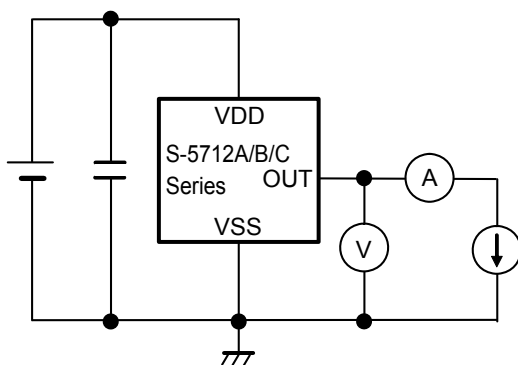

Figure 7 Test Circuit 3

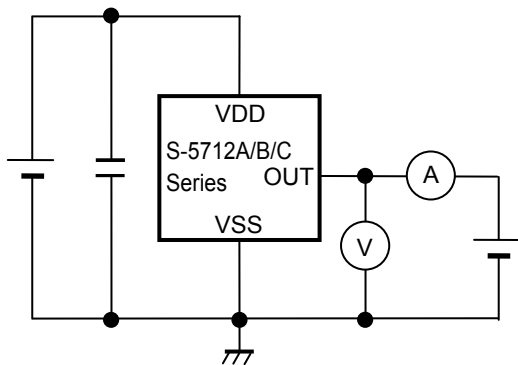
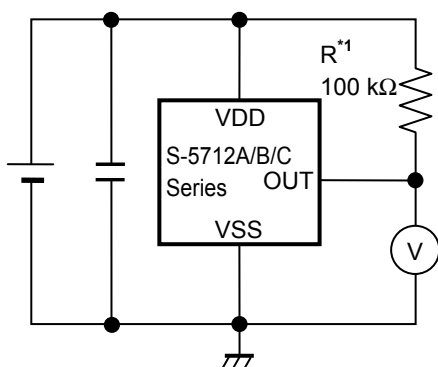

Figure 8 Test Circuit 4



\*1. Resistor (R) is unnecessary for the CMOS output product.

Figure 9 Test Circuit 5

■ Standard Circuit

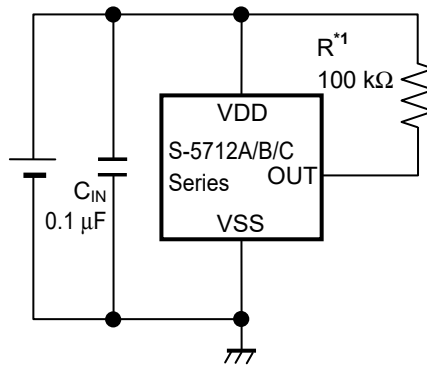

\*1. Resistor (R) is unnecessary for the CMOS output product.

Figure 10

**Caution** The above connection diagram and constants will not guarantee successful operation. Perform thorough evaluation using the actual application to set the constants.



■ Operation

1. Direction of applied magnetic flux

This IC detects the flux density which is vertical to the marking surface.

Figure 11 and Figure 12 show the direction in which magnetic flux is being applied.

1.1 SOT-23-3

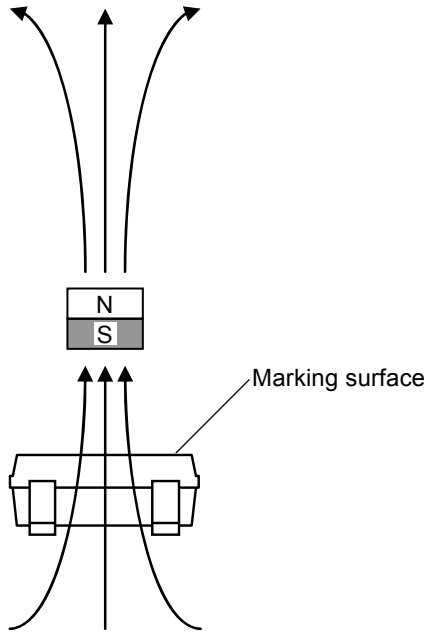

Figure 11

1.2 SNT-4A

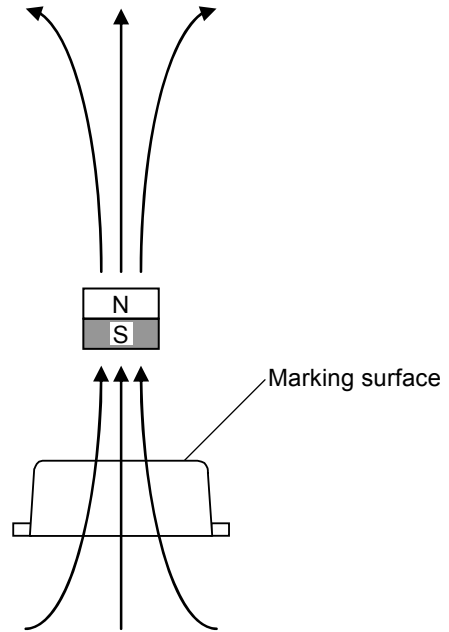

Figure 12

2. Position of Hall sensor

Figure 13 and Figure 14 show the position of Hall sensor.

The center of this Hall sensor is located in the area indicated by a circle, which is in the center of a package as described below.

The following also shows the distance (typ. value) between the marking surface and the chip surface of a package.

2.1 SOT-23-3

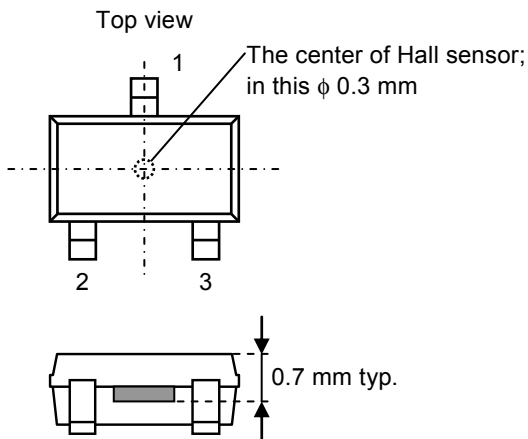

Figure 13

2.2 SNT-4A

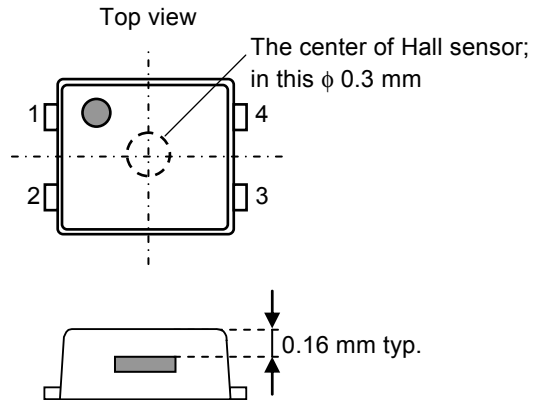

Figure 14

**3. Basic operation**

This IC changes the output voltage level ( $V_{OUT}$ ) according to the level of the magnetic flux density (N pole or S pole) applied by a magnet.

The following explains the operation when the output logic is active "L".

**3.1 Product with omnipolar detection**

When the magnetic flux density vertical to the marking surface exceeds the operation point ( $B_{OPN}$  or  $B_{OPS}$ ) after the S pole or N pole of a magnet is moved closer to the marking surface of this IC,  $V_{OUT}$  changes from "H" to "L". When the S pole or N pole of a magnet is moved further away from the marking surface of this IC and the magnetic flux density is lower than the release point ( $B_{RPN}$  or  $B_{RPS}$ ),  $V_{OUT}$  changes from "L" to "H".

**Figure 15** shows the relationship between the magnetic flux density and  $V_{OUT}$ .

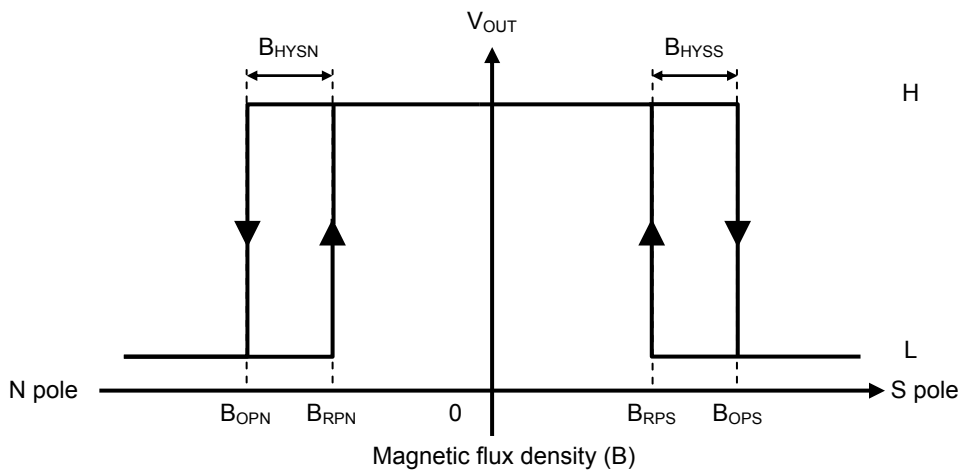
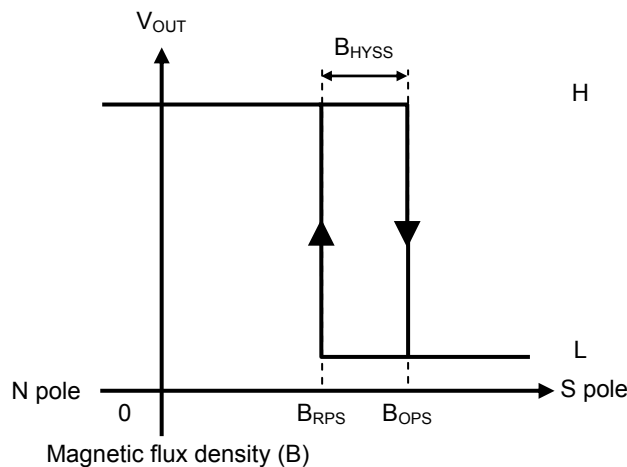

**Figure 15**

**3.2 Product with S pole detection**

When the magnetic flux density vertical to the marking surface exceeds  $B_{OPS}$  after the S pole of a magnet is moved closer to the marking surface of this IC,  $V_{OUT}$  changes from "H" to "L". When the S pole of a magnet is moved further away from the marking surface of this IC and the magnetic flux density is lower than  $B_{RPS}$ ,  $V_{OUT}$  changes from "L" to "H".

**Figure 16** shows the relationship between the magnetic flux density and  $V_{OUT}$ .

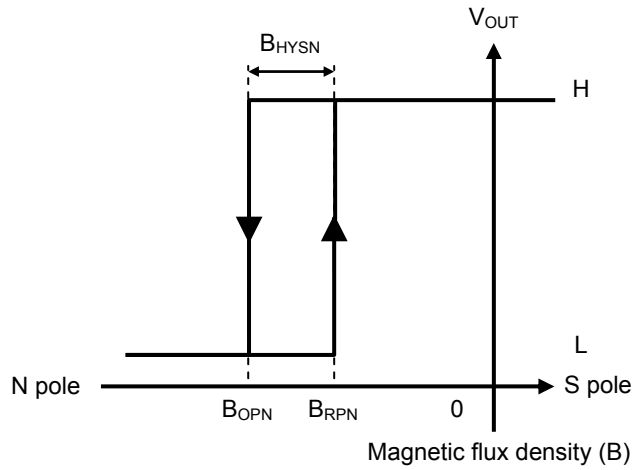

**Figure 16**

**3.3 Product with N pole detection**

When the magnetic flux density vertical to the marking surface exceeds  $B_{OPN}$  after the N pole of a magnet is moved closer to the marking surface of this IC,  $V_{OUT}$  changes from "H" to "L". When the N pole of a magnet is moved further away from the marking surface of this IC and the magnetic flux density is lower than  $B_{RPN}$ ,  $V_{OUT}$  changes from "L" to "H".

**Figure 17** shows the relationship between the magnetic flux density and  $V_{OUT}$ .



**Figure 17**

#### 4. Time dependency in the current consumption

This IC performs the intermittent operation, and operates at low current consumption due to repeating the sleep mode ( $t_{SL}$ ) and the awake mode ( $t_{AW}$ ).

Figure 18 shows the time dependency in the current consumption.

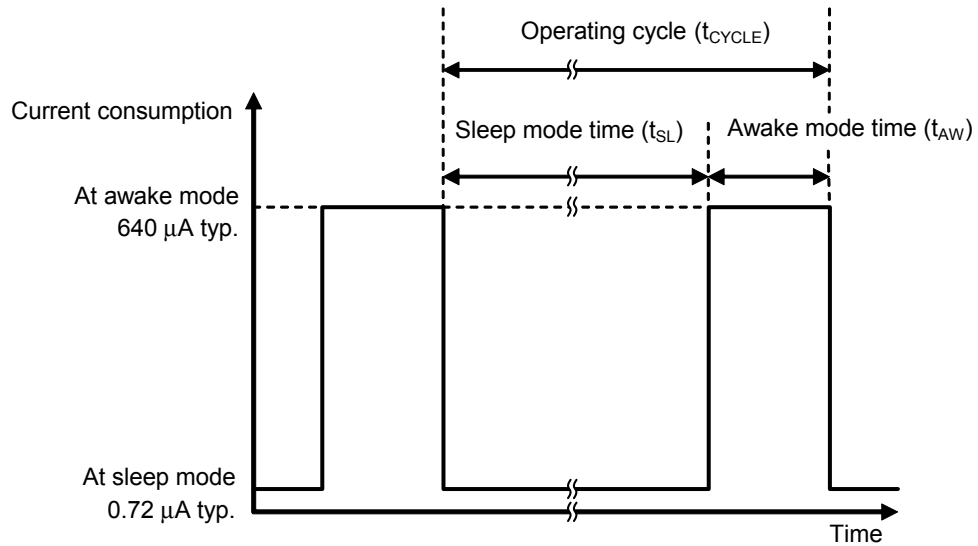

Figure 18

**5. Timing chart**

Figure 19 shows the operation timing of this IC.

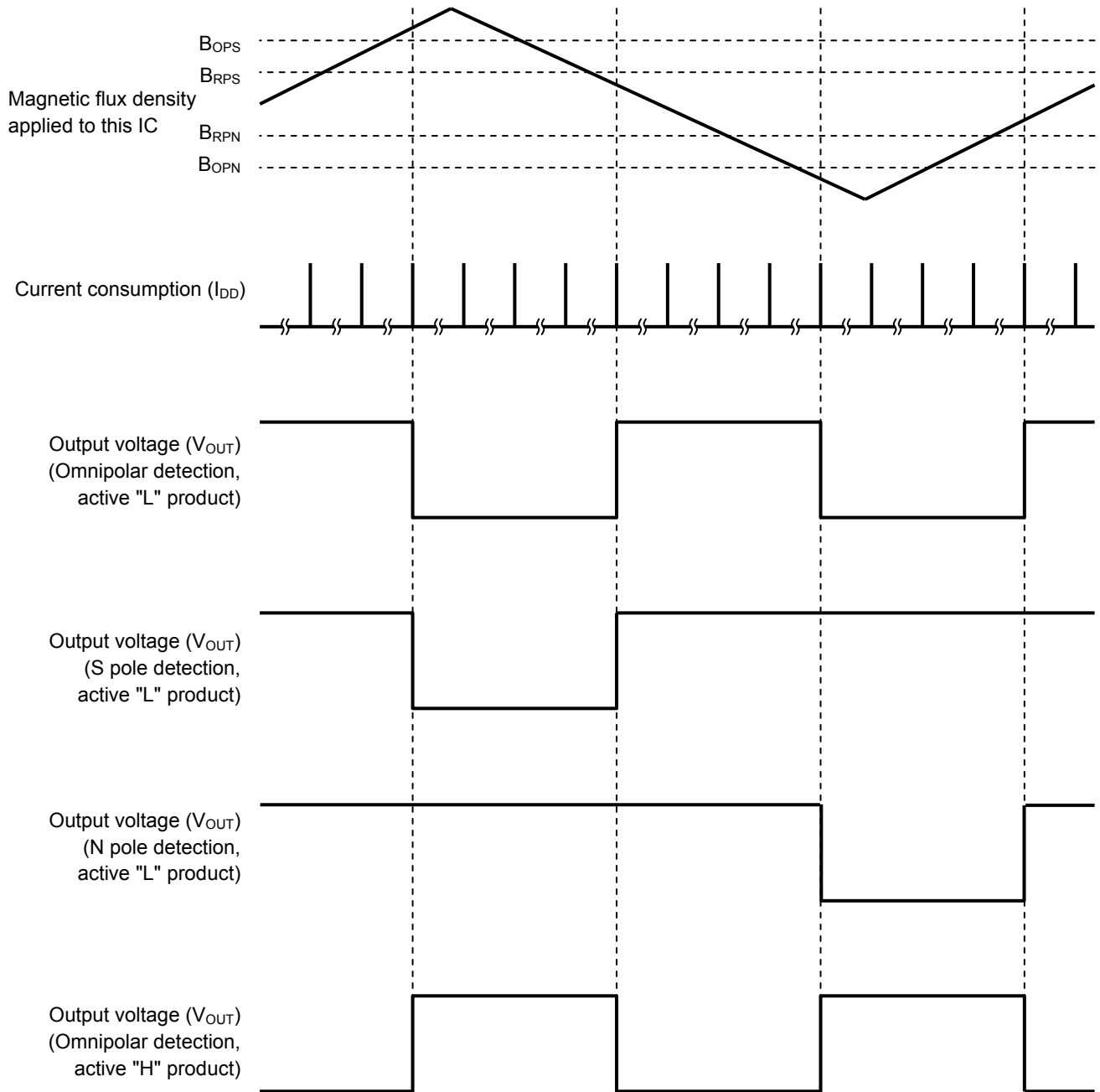

Figure 19

## ■ Precautions

- If the impedance of the power supply is high, the IC may malfunction due to a supply voltage drop caused by feed-through current. Take care with the pattern wiring to ensure that the impedance of the power supply is low.
- Note that the IC may malfunction if the power supply voltage rapidly changes.
- Do not apply an electrostatic discharge to this IC that exceeds the performance ratings of the built-in electrostatic protection circuit.
- Large stress on this IC may affect the magnetic characteristics. Avoid large stress which is caused by the handling during or after mounting the IC on a board.
- ABLIC Inc. claims no responsibility for any disputes arising out of or in connection with any infringement by products including this IC of patents owned by a third party.

■ Characteristics (Typical Data)

1. S-5712AxDxx

1.1 Operation point, release point ( $B_{OP}$ ,  $B_{RP}$ ) vs. Temperature ( $T_a$ )

1.1.1 S-5712AxDx0

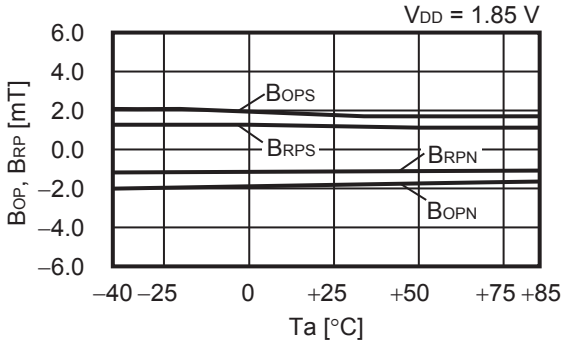

1.1.2 S-5712AxDx1

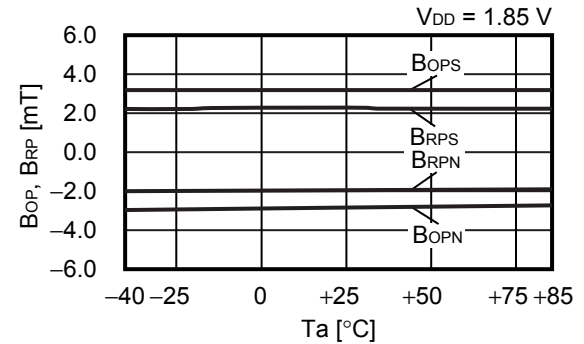

1.1.3 S-5712AxDx2

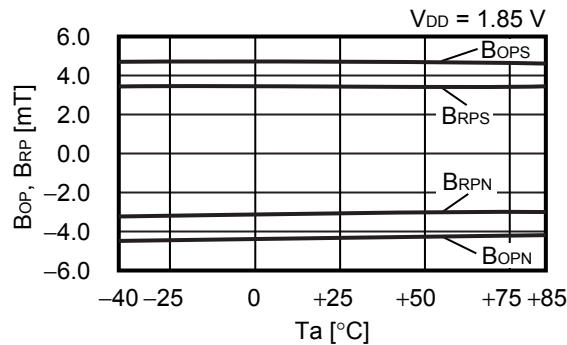

1.1.4 S-5712AxDx3

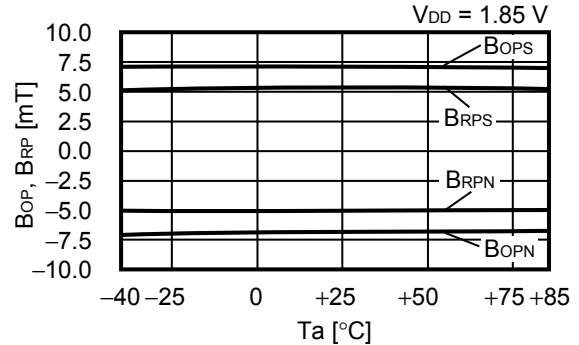

1.2 Operation point, release point ( $B_{OP}$ ,  $B_{RP}$ ) vs. Power supply voltage ( $V_{DD}$ )

1.2.1 S-5712AxDx0

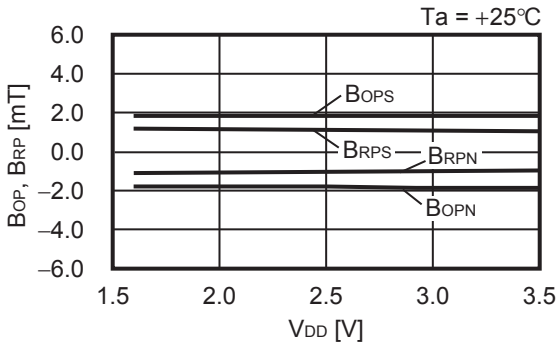

1.2.2 S-5712AxDx1

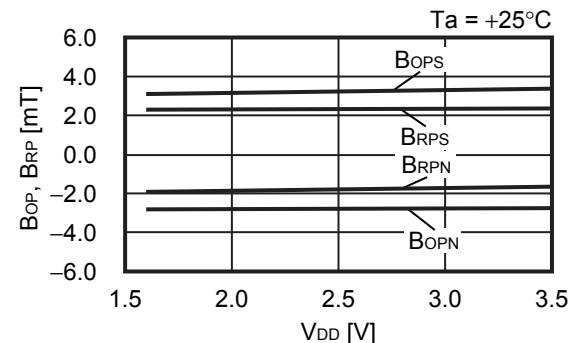

1.2.3 S-5712AxDx2

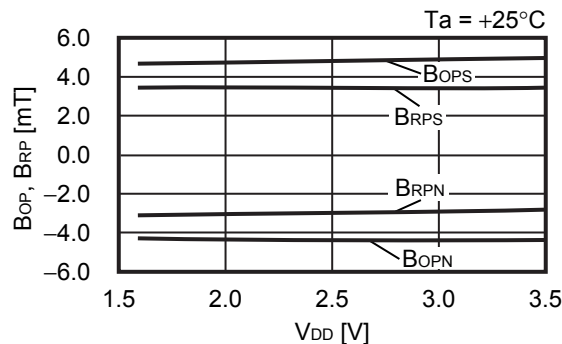

1.2.4 S-5712AxDx3

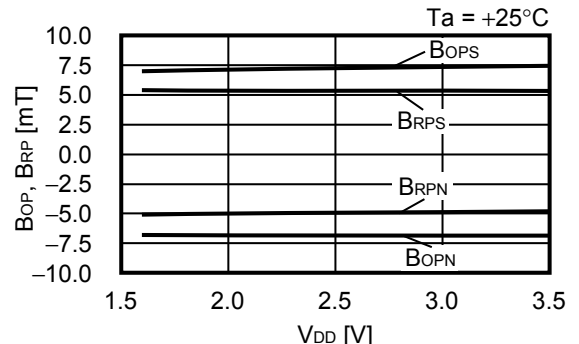

1.3 Current consumption ( $I_{DD}$ ) vs. Temperature ( $T_a$ )

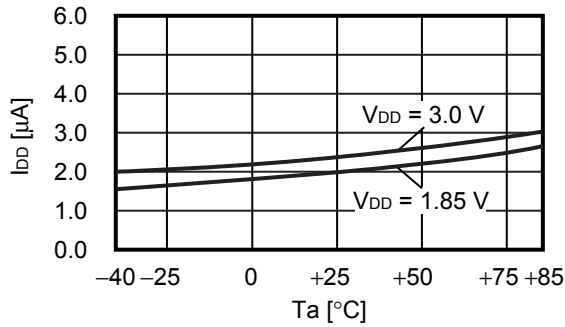

1.4 Current consumption ( $I_{DD}$ ) vs. Power supply voltage ( $V_{DD}$ )

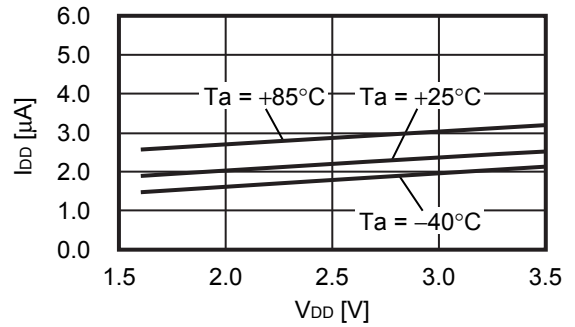

1.5 Awake mode time ( $t_{AW}$ ) vs. Temperature ( $T_a$ )

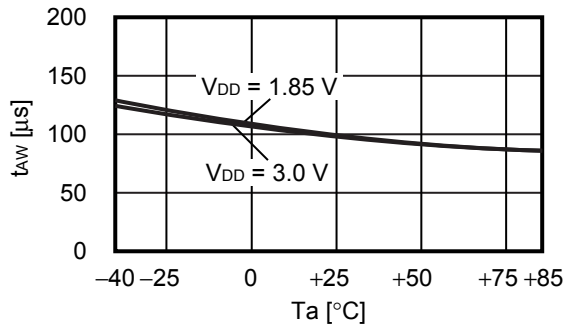

1.6 Awake mode time ( $t_{AW}$ ) vs. Power supply voltage ( $V_{DD}$ )

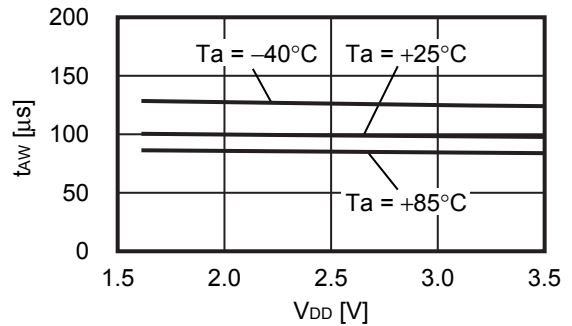

1.7 Sleep mode time ( $t_{SL}$ ) vs. Temperature ( $T_a$ )

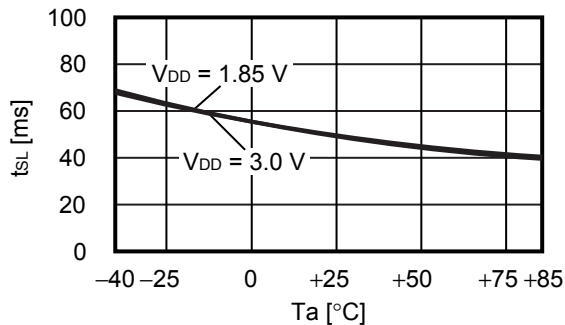

1.8 Sleep mode time ( $t_{SL}$ ) vs. Power supply voltage ( $V_{DD}$ )

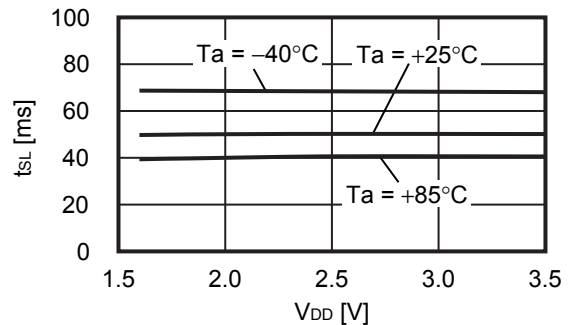



**2. S-5712AxSxx, S-5712AxNxx**

**2.1 Operation point, release point ( $B_{OP}$ ,  $B_{RP}$ ) vs. Temperature ( $T_a$ )**

**2.1.1 S-5712AxSx1**

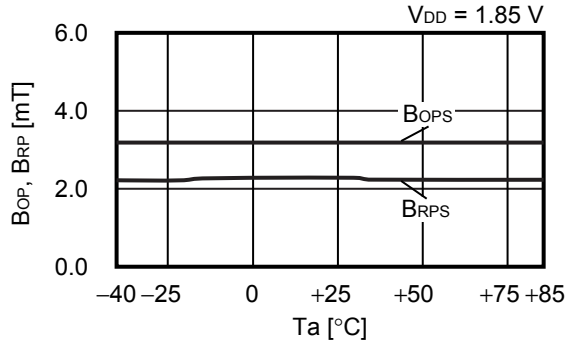

**2.1.2 S-5712AxSx2**

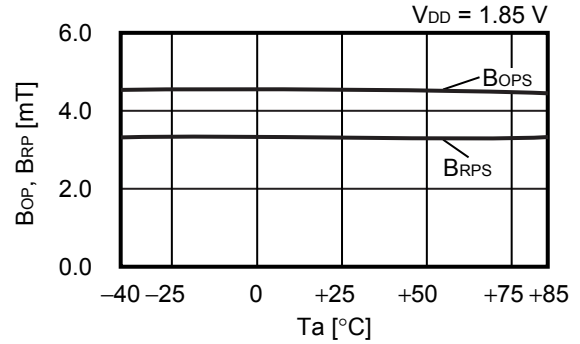

**2.1.3 S-5712AxNx1**

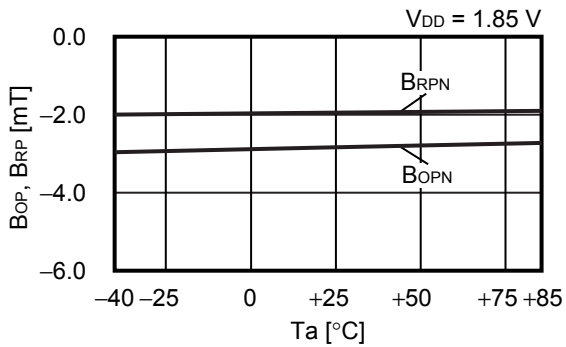

**2.1.4 S-5712AxNx2**

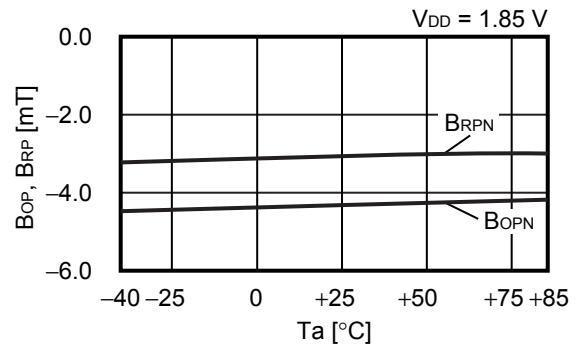

**2.1.5 S-5712AxNx3**

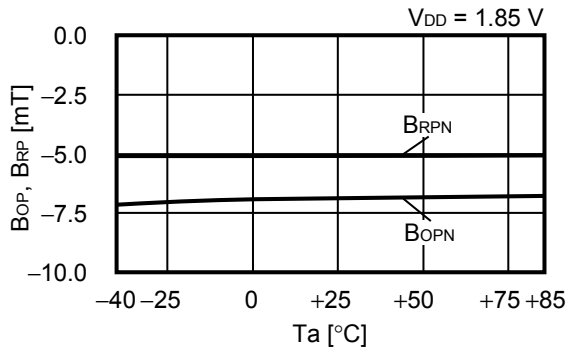

**2. 2 Operation point, release point ( $B_{OP}$ ,  $B_{RP}$ ) vs. Power supply voltage ( $V_{DD}$ )**

**2. 2. 1 S-5712AxSx1**

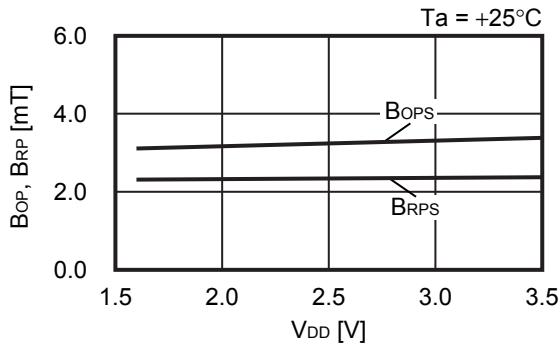

**2. 2. 2 S-5712AxSx2**

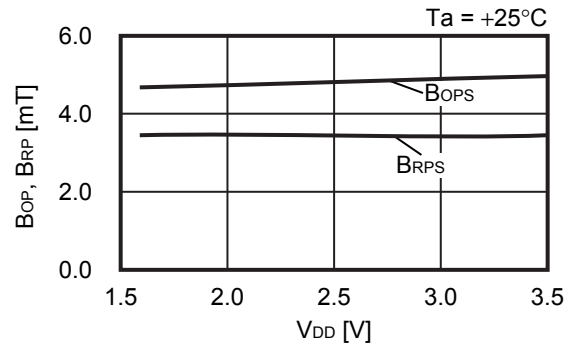

**2. 2. 3 S-5712AxNx1**

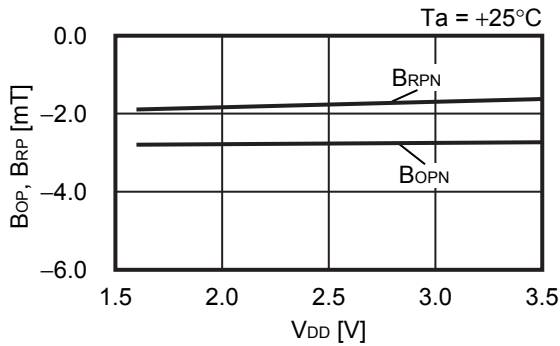

**2. 2. 4 S-5712AxNx2**

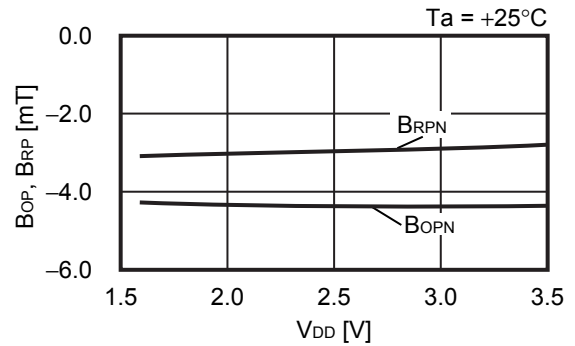

**2. 2. 5 S-5712AxNx3**

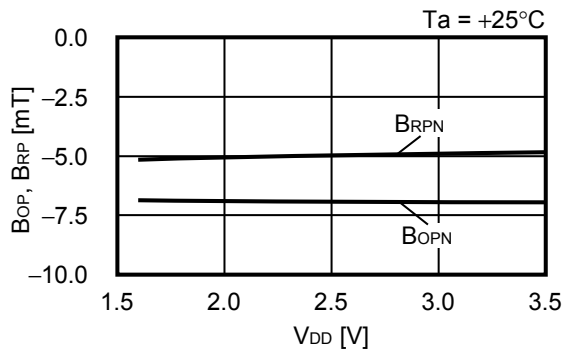

**2.3 Current consumption ( $I_{DD}$ ) vs. Temperature ( $T_a$ )**

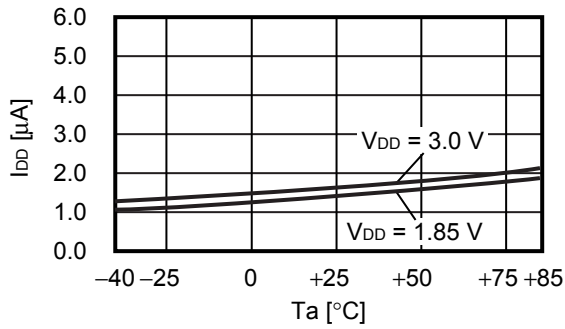

**2.4 Current consumption ( $I_{DD}$ ) vs. Power supply voltage ( $V_{DD}$ )**

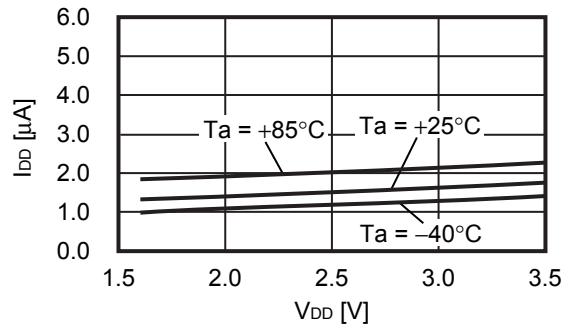

**2.5 Awake mode time ( $t_{AW}$ ) vs. Temperature ( $T_a$ )**

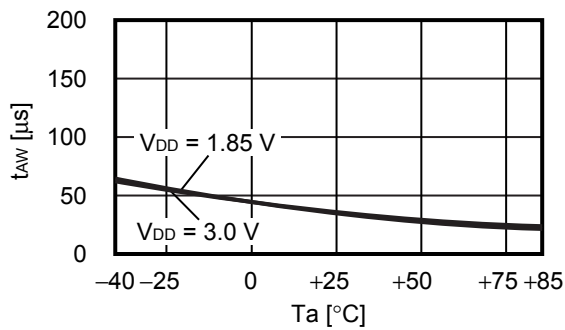

**2.6 Awake mode time ( $t_{AW}$ ) vs. Power supply voltage ( $V_{DD}$ )**

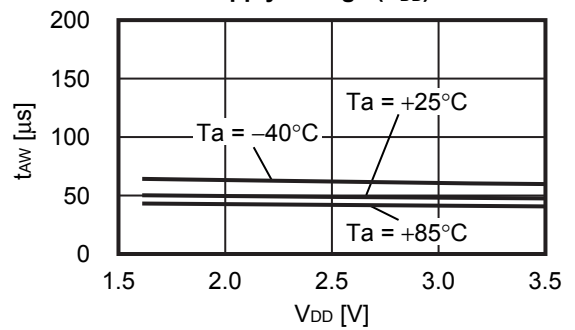

**2.7 Sleep mode time ( $t_{SL}$ ) vs. Temperature ( $T_a$ )**

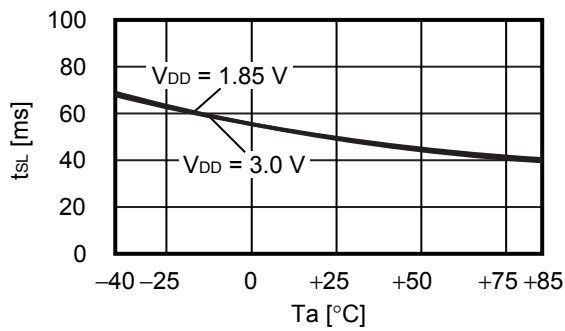

**2.8 Sleep mode time ( $t_{SL}$ ) vs. Power supply voltage ( $V_{DD}$ )**

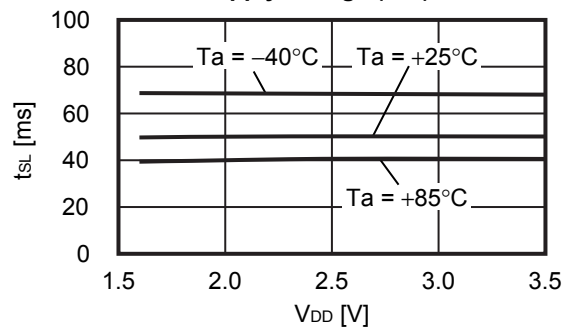

**3. S-5712BxDxx**

**3.1 Operation point, release point ( $B_{OP}$ ,  $B_{RP}$ ) vs. Temperature ( $T_a$ )**

**3.1.1 S-5712BxDx1**

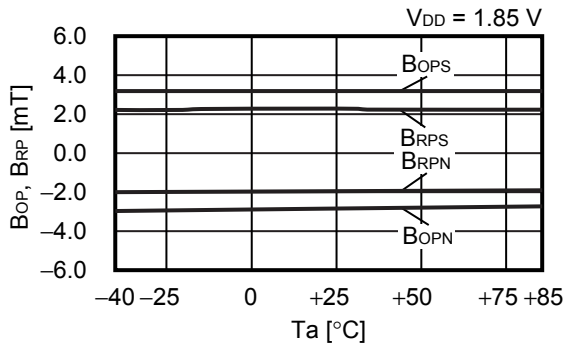

**3.1.2 S-5712BxDx2**

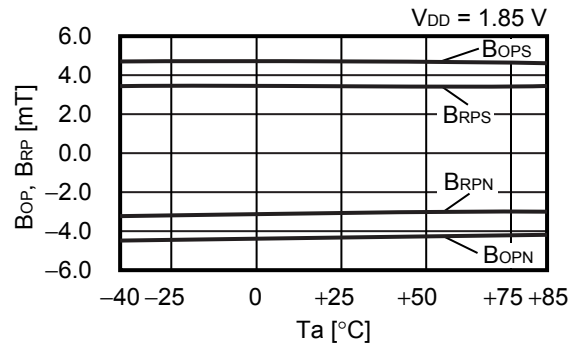

**3.2 Operation point, release point ( $B_{OP}$ ,  $B_{RP}$ ) vs. Power supply voltage ( $V_{DD}$ )**

**3.2.1 S-5712BxDx1**

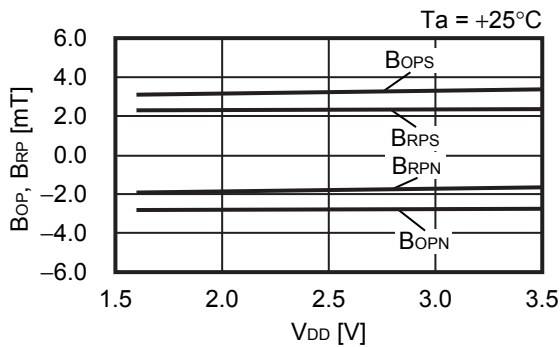

**3.2.2 S-5712BxDx2**

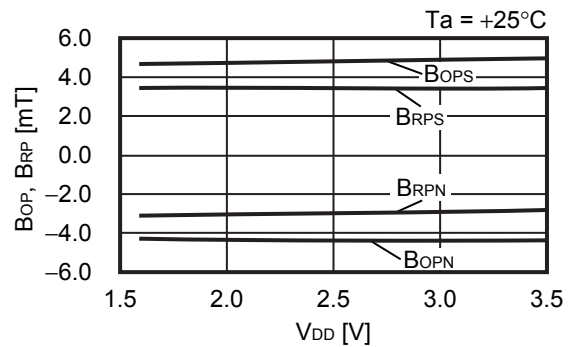

**3.3 Current consumption ( $I_{DD}$ ) vs. Temperature ( $T_a$ )**

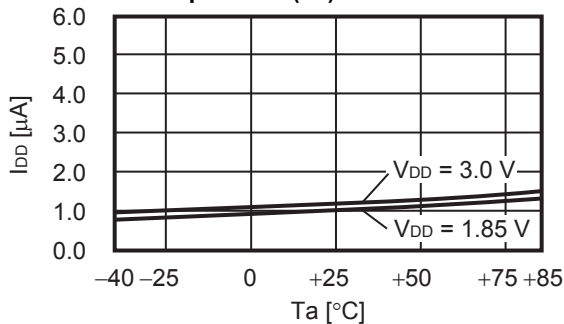

**3.4 Current consumption ( $I_{DD}$ ) vs. Power supply voltage ( $V_{DD}$ )**

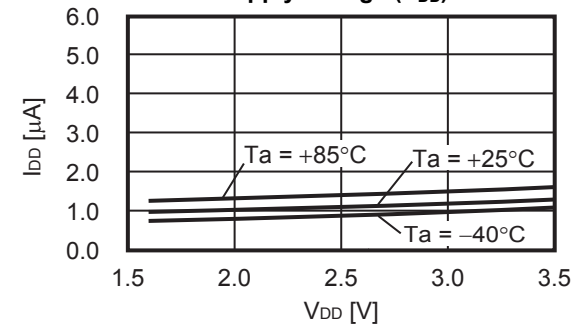

**3.5 Awake mode time ( $t_{AW}$ ) vs. Temperature ( $T_a$ )**

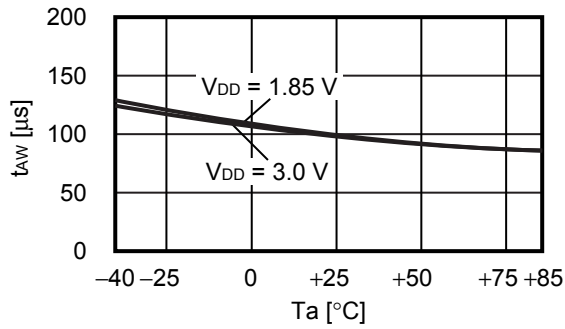

**3.6 Awake mode time ( $t_{AW}$ ) vs. Power supply voltage ( $V_{DD}$ )**

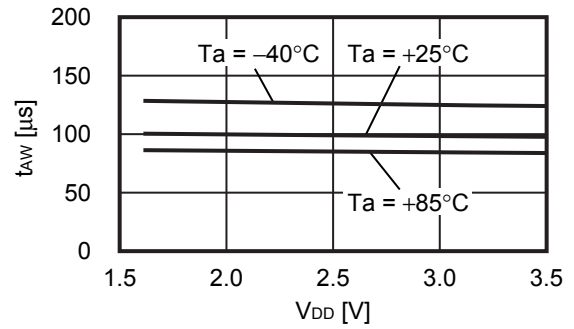

**3.7 Sleep mode time ( $t_{SL}$ ) vs. Temperature ( $T_a$ )**

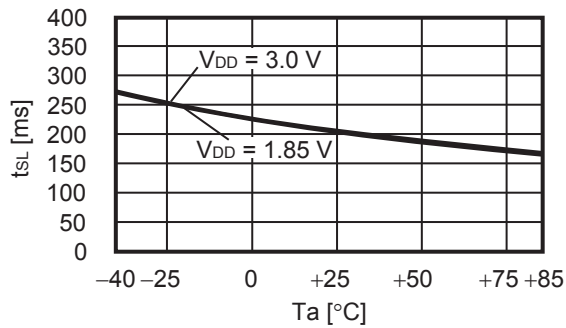

**3.8 Sleep mode time ( $t_{SL}$ ) vs. Power supply voltage ( $V_{DD}$ )**

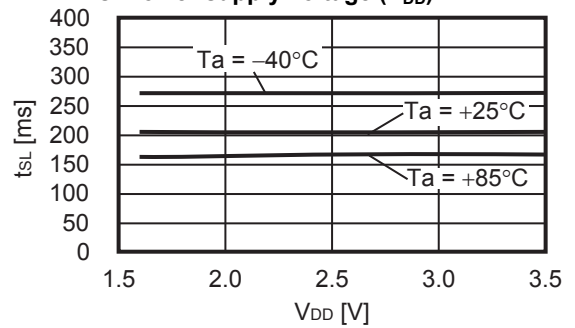

**4. S-5712BxSxx, S-5712BxNxx**

**4.1 Operation point, release point ( $B_{OP}$ ,  $B_{RP}$ ) vs. Temperature ( $T_a$ )**

**4.1.1 S-5712BxSx2**

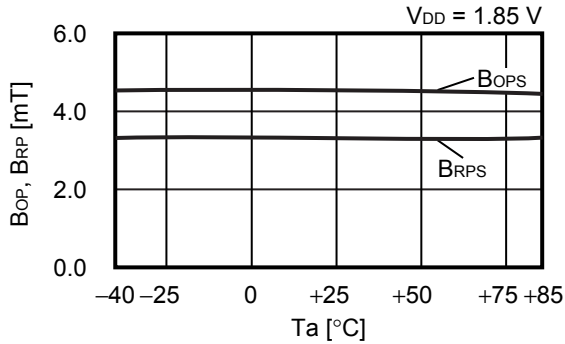

**4.2 Operation point, release point ( $B_{OP}$ ,  $B_{RP}$ ) vs. Power supply voltage ( $V_{DD}$ )**

**4.2.1 S-5712BxSx2**

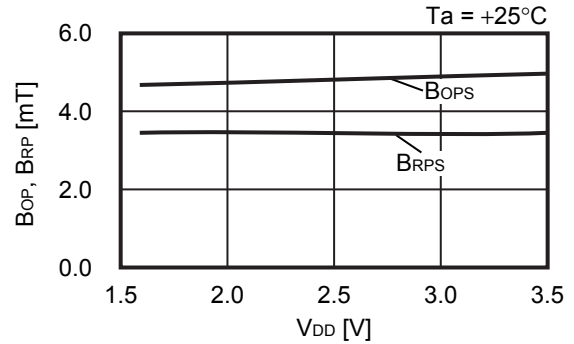

**4.3 Current consumption ( $I_{DD}$ ) vs. Temperature ( $T_a$ )**

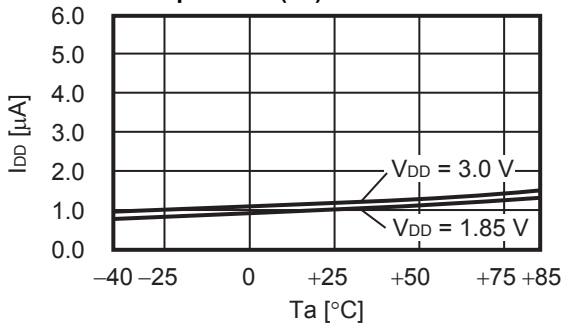

**4.4 Current consumption ( $I_{DD}$ ) vs. Power supply voltage ( $V_{DD}$ )**

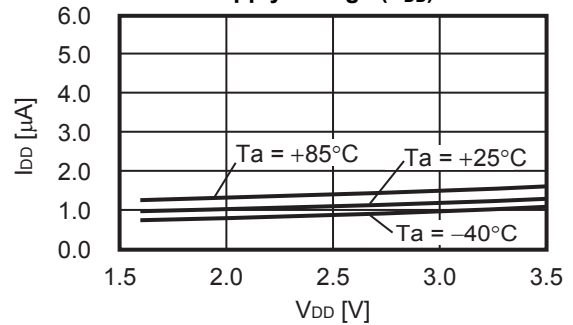

**4.5 Awake mode time ( $t_{AW}$ ) vs. Temperature ( $T_a$ )**

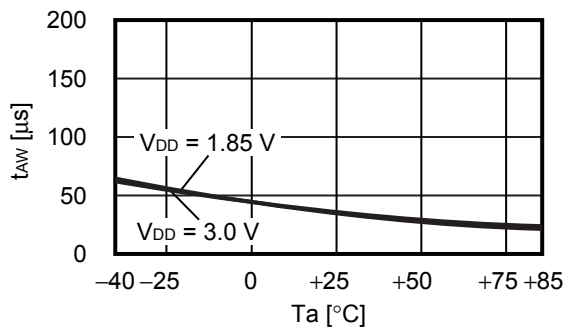

**4.6 Awake mode time ( $t_{AW}$ ) vs. Power supply voltage ( $V_{DD}$ )**

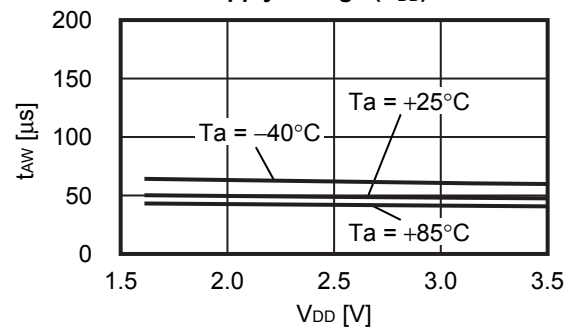

**4.7 Sleep mode time ( $t_{SL}$ ) vs. Temperature ( $T_a$ )**

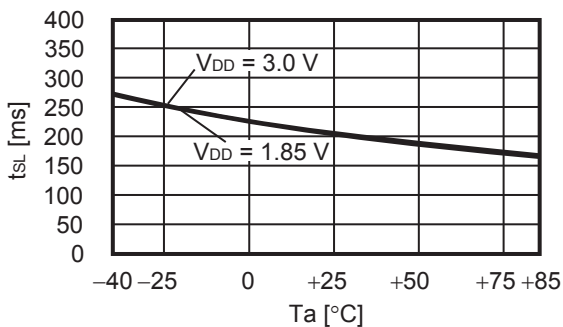

**4.8 Sleep mode time ( $t_{SL}$ ) vs. Power supply voltage ( $V_{DD}$ )**

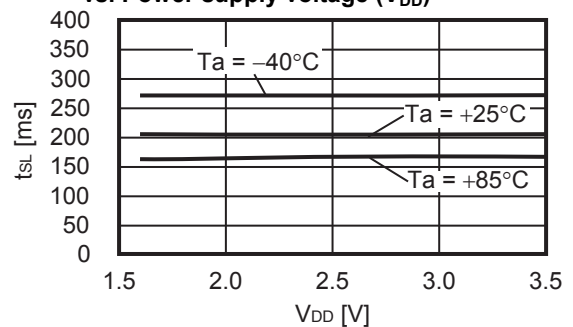

**5. S-5712CxDxx**

**5.1 Operation point, release point ( $B_{OP}$ ,  $B_{RP}$ ) vs. Temperature ( $T_a$ )**

**5.1.1 S-5712Cx Dx1**

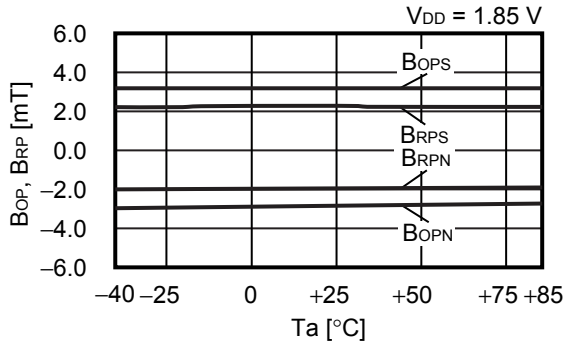

**5.1.2 S-5712Cx Dx2**

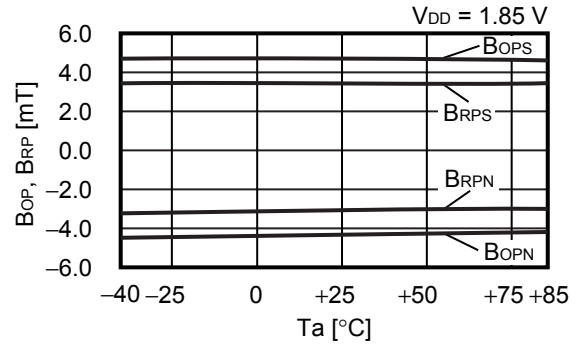

**5.2 Operation point, release point ( $B_{OP}$ ,  $B_{RP}$ ) vs. Power supply voltage ( $V_{DD}$ )**

**5.2.1 S-5712Cx Dx1**

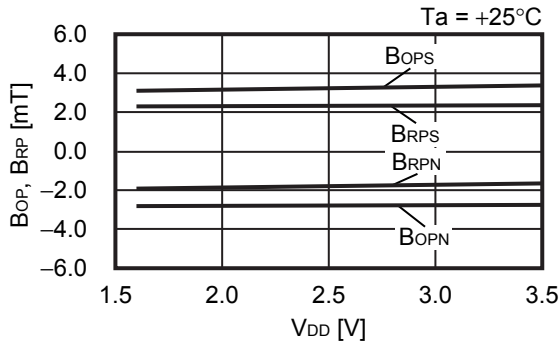

**5.2.2 S-5712Cx Dx2**

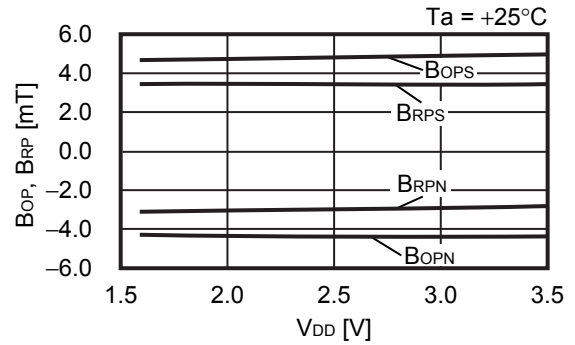

**5.3 Current consumption ( $I_{DD}$ ) vs. Temperature ( $T_a$ )**

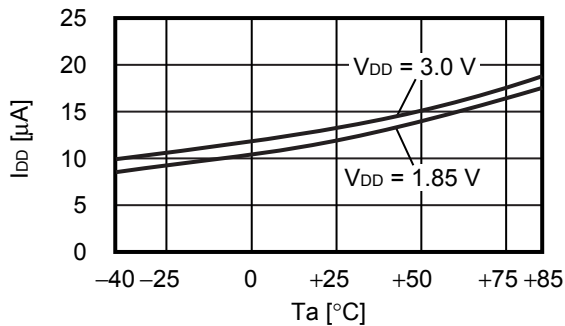

**5.4 Current consumption ( $I_{DD}$ ) vs. Power supply voltage ( $V_{DD}$ )**

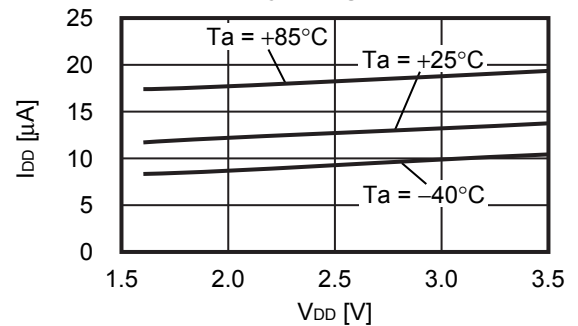

**5.5 Awake mode time ( $t_{AW}$ ) vs. Temperature ( $T_a$ )**

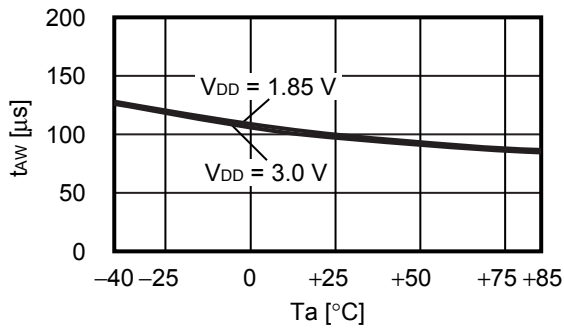

**5.6 Awake mode time ( $t_{AW}$ ) vs. Power supply voltage ( $V_{DD}$ )**

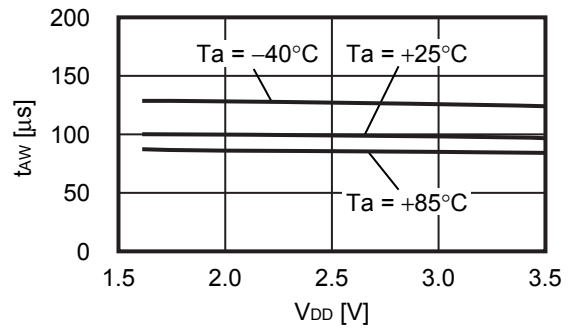

**5.7 Sleep mode time ( $t_{SL}$ ) vs. Temperature ( $T_a$ )**

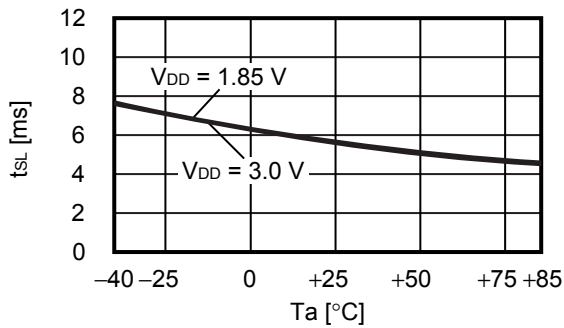

**5.8 Sleep mode time ( $t_{SL}$ ) vs. Power supply voltage ( $V_{DD}$ )**

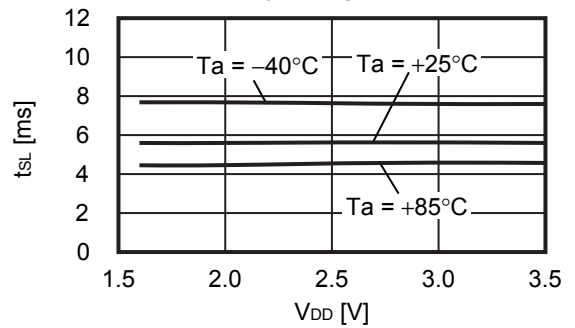



**6. S-5712CxSxx, S-5712CxNxx**

**6.1 Operation point, release point ( $B_{OP}$ ,  $B_{RP}$ ) vs. Temperature ( $T_a$ )**

**6.1.1 S-5712CxSx1**

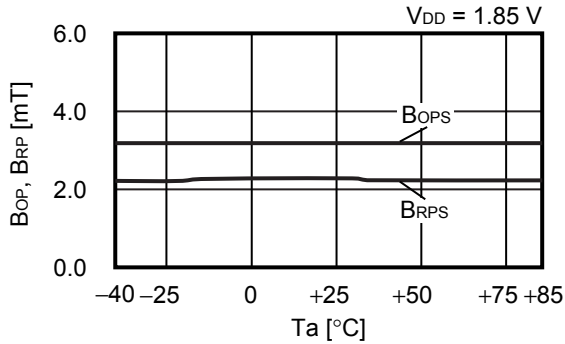

**6.1.2 S-5712CxSx2**

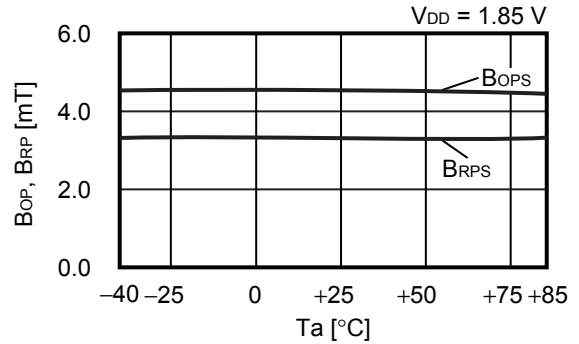

**6.1.3 S-5712CxNx1**

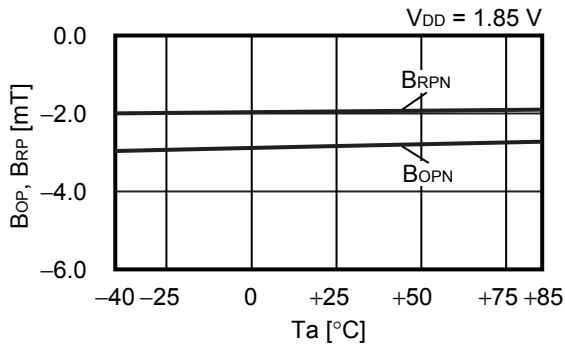

**6.1.4 S-5712CxNx2**

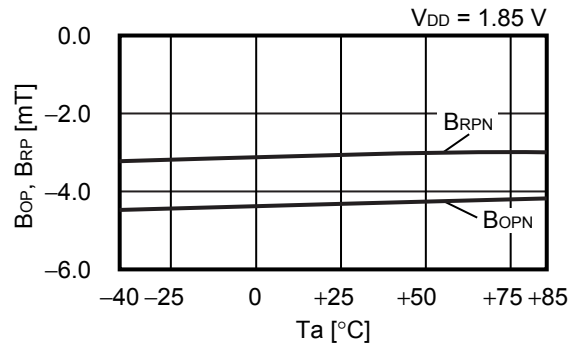

**6.2 Operation point, release point ( $B_{OP}$ ,  $B_{RP}$ ) vs. Power supply voltage ( $V_{DD}$ )**

**6.2.1 S-5712CxSx1**

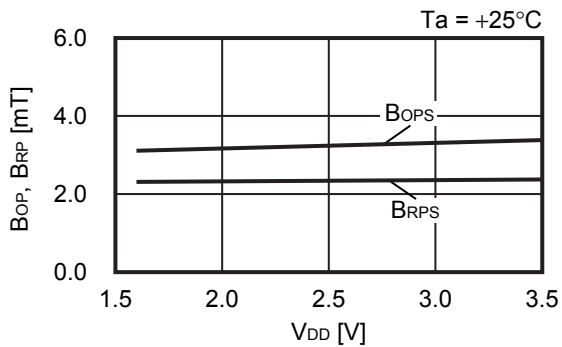

**6.2.2 S-5712CxSx2**

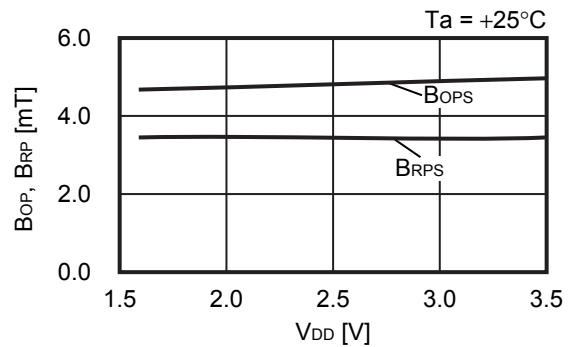

**6.2.3 S-5712CxNx1**

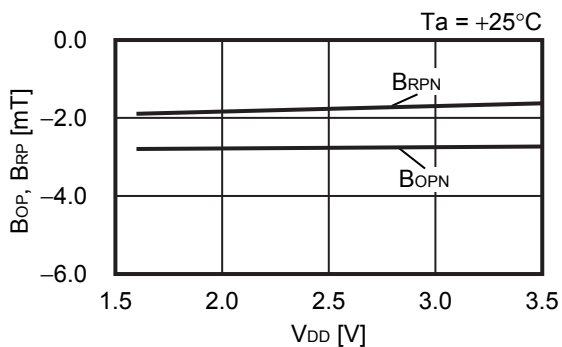

**6.2.4 S-5712CxNx2**

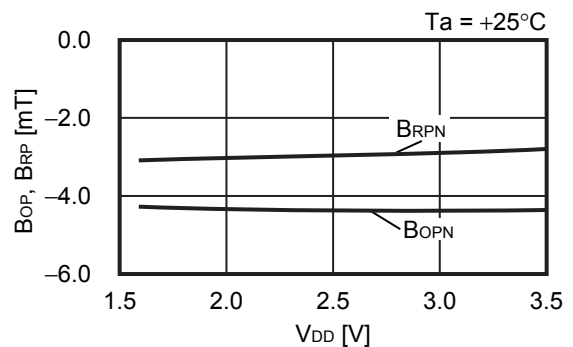

**6.3 Current consumption ( $I_{DD}$ ) vs. Temperature ( $T_a$ )**

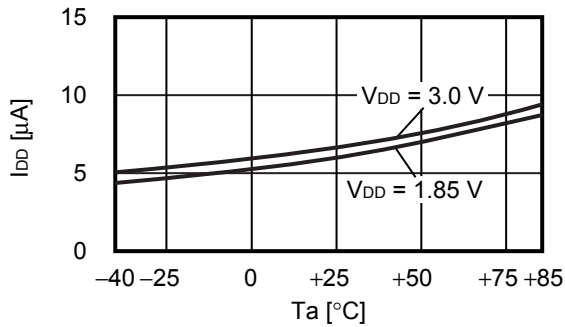

**6.4 Current consumption ( $I_{DD}$ ) vs. Power supply voltage ( $V_{DD}$ )**

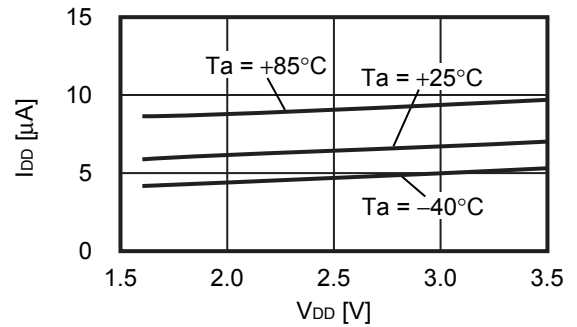

**6.5 Awake mode time ( $t_{AW}$ ) vs. Temperature ( $T_a$ )**

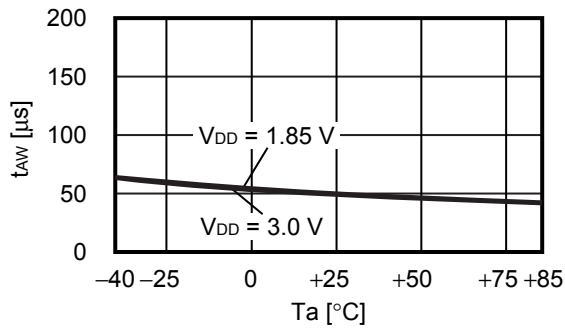

**6.6 Awake mode time ( $t_{AW}$ ) vs. Power supply voltage ( $V_{DD}$ )**

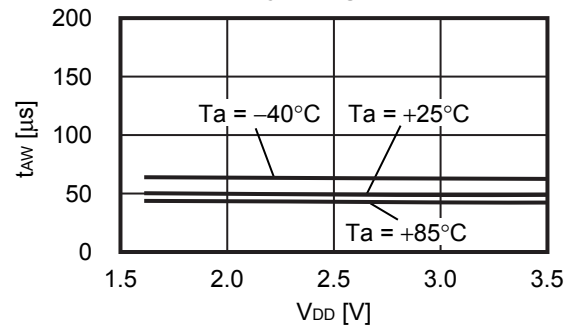

**6.7 Sleep mode time ( $t_{SL}$ ) vs. Temperature ( $T_a$ )**

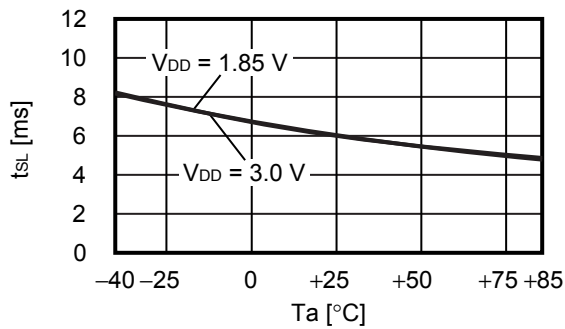

**6.8 Sleep mode time ( $t_{SL}$ ) vs. Power supply voltage ( $V_{DD}$ )**

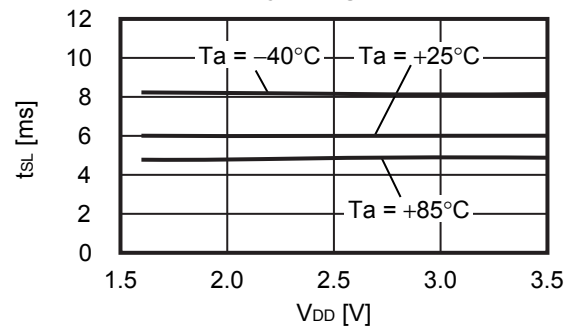

■ Power Dissipation

SOT-23-3

SNT-4A

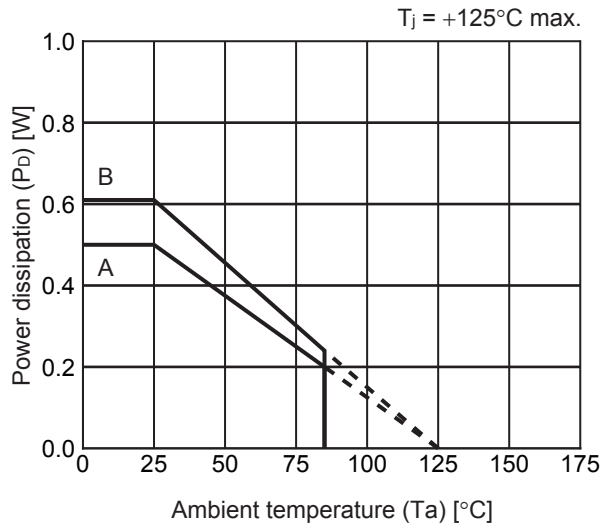

Board	Power Dissipation ( $P_D$ )
A	0.50 W
B	0.61 W
C	—
D	—
E	—

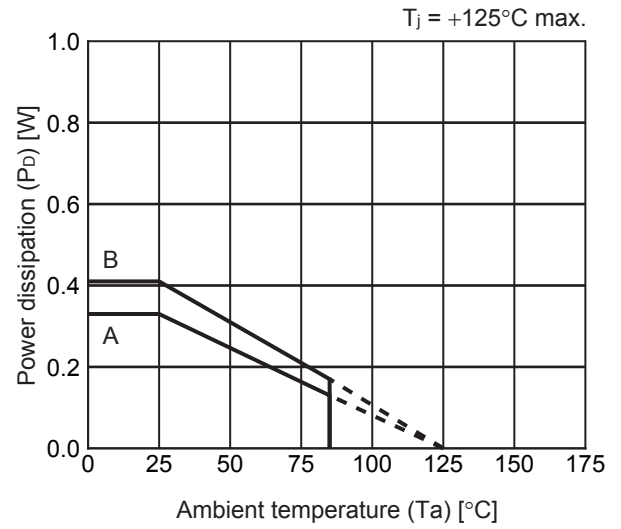

Board	Power Dissipation ( $P_D$ )
A	0.33 W
B	0.41 W
C	—
D	—
E	—

# SOT-23-3/3S/5/6 Test Board

 IC Mount Area

(1) Board A



Item		Specification
Size [mm]		114.3 x 76.2 x t1.6
Material		FR-4
Number of copper foil layer		2
Copper foil layer [mm]	1	Land pattern and wiring for testing: t0.070
	2	-
	3	-
	4	74.2 x 74.2 x t0.070
Thermal via		-

(2) Board B



Item		Specification
Size [mm]		114.3 x 76.2 x t1.6
Material		FR-4
Number of copper foil layer		4
Copper foil layer [mm]	1	Land pattern and wiring for testing: t0.070
	2	74.2 x 74.2 x t0.035
	3	74.2 x 74.2 x t0.035
	4	74.2 x 74.2 x t0.070
Thermal via		-

No. SOT23x-A-Board-SD-2.0

# SNT-4A Test Board

(1) Board A

 IC Mount Area

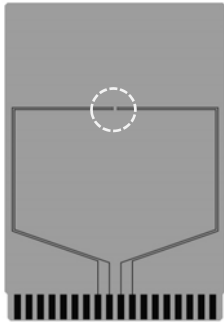

Item		Specification
Size [mm]		114.3 x 76.2 x t1.6
Material		FR-4
Number of copper foil layer		2
Copper foil layer [mm]	1	Land pattern and wiring for testing: t0.070
	2	-
	3	-
	4	74.2 x 74.2 x t0.070
Thermal via		-

(2) Board B

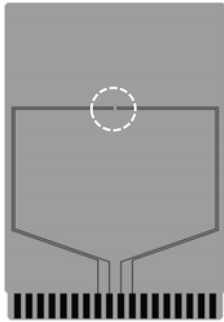

Item		Specification
Size [mm]		114.3 x 76.2 x t1.6
Material		FR-4
Number of copper foil layer		4
Copper foil layer [mm]	1	Land pattern and wiring for testing: t0.070
	2	74.2 x 74.2 x t0.035
	3	74.2 x 74.2 x t0.035
	4	74.2 x 74.2 x t0.070
Thermal via		-

No. SNT4A-A-Board-SD-1.0

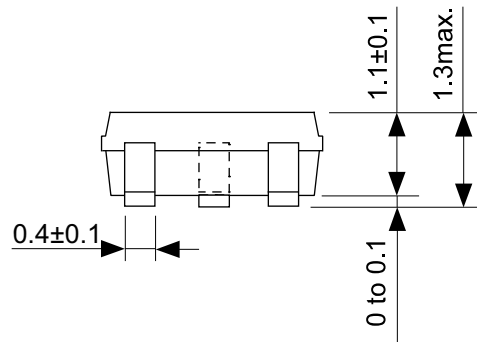
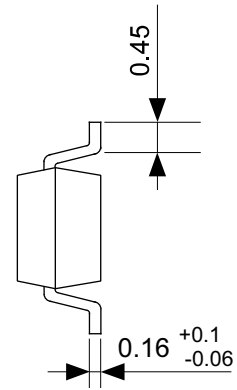

No. MP003-C-P-SD-1.1

TITLE	SOT233-C-PKG Dimensions
No.	MP003-C-P-SD-1.1
ANGLE	
UNIT	mm
<b>ABLIC Inc.</b>	

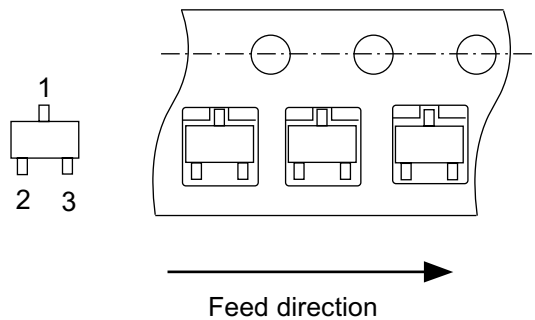

No. MP003-C-C-SD-2.0

TITLE	SOT233-C-Carrier Tape
No.	MP003-C-C-SD-2.0
ANGLE	
UNIT	mm
<b>ABLIC Inc.</b>	



Enlarged drawing in the central part



No. MP003-Z-R-SD-1.0

TITLE	SOT233-C-Reel		
No.	MP003-Z-R-SD-1.0		
ANGLE		QTY.	3,000
UNIT	mm		
<b>ABLIC Inc.</b>			



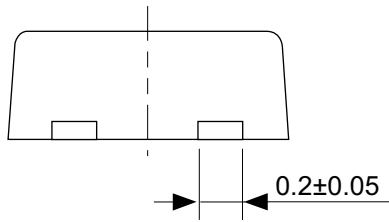
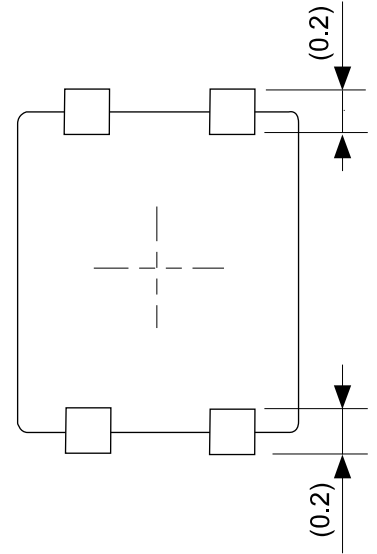
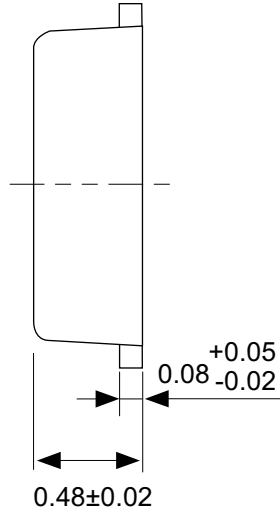

No. PF004-A-P-SD-6.0

TITLE	SNT-4A-A-PKG Dimensions
No.	PF004-A-P-SD-6.0
ANGLE	
UNIT	mm
<b>ABLIC Inc.</b>	



Feed direction →

No. PF004-A-C-SD-2.0

TITLE	SNT-4A-A-Carrier Tape
No.	PF004-A-C-SD-2.0
ANGLE	
UNIT	mm
<b>ABLIC Inc.</b>	



Enlarged drawing in the central part



No. PF004-A-R-SD-1.0

TITLE	SNT-4A-A-Reel		
No.	PF004-A-R-SD-1.0		
ANGLE		QTY.	5,000
UNIT	mm		
<b>ABLIC Inc.</b>			

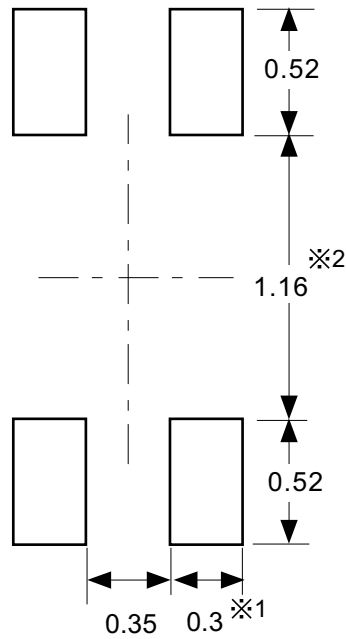

※1. ランドパターンの幅に注意してください (0.25 mm min. / 0.30 mm typ.).

※2. パッケージ中央にランドパターンを広げないでください (1.10 mm ~ 1.20 mm)。

- 注意
1. パッケージのモールド樹脂下にシルク印刷やハンダ印刷などしないでください。
  2. パッケージ下の配線上のソルダーレジストなどの厚みをランドパターン表面から0.03 mm 以下にしてください。
  3. マスク開口サイズと開口位置はランドパターンと合わせてください。
  4. 詳細は "SNTパッケージ活用の手引き" を参照してください。

※1. Pay attention to the land pattern width (0.25 mm min. / 0.30 mm typ.).

※2. Do not widen the land pattern to the center of the package (1.10 mm to 1.20 mm).

- Caution**
1. Do not do silkscreen printing and solder printing under the mold resin of the package.
  2. The thickness of the solder resist on the wire pattern under the package should be 0.03 mm or less from the land pattern surface.
  3. Match the mask aperture size and aperture position with the land pattern.
  4. Refer to "SNT Package User's Guide" for details.

※1. 请注意焊盘模式的宽度 (0.25 mm min. / 0.30 mm typ.).

※2. 请勿向封装中间扩展焊盘模式 (1.10 mm ~ 1.20 mm)。

- 注意
1. 请勿在树脂型封装的下面印刷丝网、焊锡。
  2. 在封装下、布线上的阻焊膜厚度 (从焊盘模式表面起) 请控制在 0.03 mm 以下。
  3. 钢网的开口尺寸和开口位置请与焊盘模式对齐。
  4. 详细内容请参阅 "SNT 封装的应用指南"。

No. PF004-A-L-SD-4.1

TITLE	SNT-4A-A -Land Recommendation
No.	PF004-A-L-SD-4.1
ANGLE	
UNIT	mm
<b>ABLIC Inc.</b>	

## Disclaimers (Handling Precautions)

1. All the information described herein (product data, specifications, figures, tables, programs, algorithms and application circuit examples, etc.) is current as of publishing date of this document and is subject to change without notice.
2. The circuit examples and the usages described herein are for reference only, and do not guarantee the success of any specific mass-production design.  
ABLIC Inc. is not liable for any losses, damages, claims or demands caused by the reasons other than the products described herein (hereinafter "the products") or infringement of third-party intellectual property right and any other right due to the use of the information described herein.
3. ABLIC Inc. is not liable for any losses, damages, claims or demands caused by the incorrect information described herein.
4. Be careful to use the products within their ranges described herein. Pay special attention for use to the absolute maximum ratings, operation voltage range and electrical characteristics, etc.  
ABLIC Inc. is not liable for any losses, damages, claims or demands caused by failures and / or accidents, etc. due to the use of the products outside their specified ranges.
5. Before using the products, confirm their applications, and the laws and regulations of the region or country where they are used and verify suitability, safety and other factors for the intended use.
6. When exporting the products, comply with the Foreign Exchange and Foreign Trade Act and all other export-related laws, and follow the required procedures.
7. The products are strictly prohibited from using, providing or exporting for the purposes of the development of weapons of mass destruction or military use. ABLIC Inc. is not liable for any losses, damages, claims or demands caused by any provision or export to the person or entity who intends to develop, manufacture, use or store nuclear, biological or chemical weapons or missiles, or use any other military purposes.
8. The products are not designed to be used as part of any device or equipment that may affect the human body, human life, or assets (such as medical equipment, disaster prevention systems, security systems, combustion control systems, infrastructure control systems, vehicle equipment, traffic systems, in-vehicle equipment, aviation equipment, aerospace equipment, and nuclear-related equipment), excluding when specified for in-vehicle use or other uses by ABLIC, Inc. Do not apply the products to the above listed devices and equipments.  
ABLIC Inc. is not liable for any losses, damages, claims or demands caused by unauthorized or unspecified use of the products.
9. In general, semiconductor products may fail or malfunction with some probability. The user of the products should therefore take responsibility to give thorough consideration to safety design including redundancy, fire spread prevention measures, and malfunction prevention to prevent accidents causing injury or death, fires and social damage, etc. that may ensue from the products' failure or malfunction.  
The entire system in which the products are used must be sufficiently evaluated and judged whether the products are allowed to apply for the system on customer's own responsibility.
10. The products are not designed to be radiation-proof. The necessary radiation measures should be taken in the product design by the customer depending on the intended use.
11. The products do not affect human health under normal use. However, they contain chemical substances and heavy metals and should therefore not be put in the mouth. The fracture surfaces of wafers and chips may be sharp. Be careful when handling these with the bare hands to prevent injuries, etc.
12. When disposing of the products, comply with the laws and ordinances of the country or region where they are used.
13. The information described herein contains copyright information and know-how of ABLIC Inc. The information described herein does not convey any license under any intellectual property rights or any other rights belonging to ABLIC Inc. or a third party. Reproduction or copying of the information from this document or any part of this document described herein for the purpose of disclosing it to a third-party is strictly prohibited without the express permission of ABLIC Inc.
14. For more details on the information described herein or any other questions, please contact ABLIC Inc.'s sales representative.
15. This Disclaimers have been delivered in a text using the Japanese language, which text, despite any translations into the English language and the Chinese language, shall be controlling.

2.4-2019.07