



THADEUS REFERENCE MANUAL

AMB4426 / 260503114100x

VERSION 3.4

MAY 28, 2020

Revision history

Manual version	FW version	HW version	Notes	Date
1.0 - 2.12	-	-	<ul style="list-style-type: none"> Initial versions 	January 2018
3.0	2.1.0	5.1	<ul style="list-style-type: none"> New corporate design and structure 	November 2018
3.1	2.1.0	5.1	<ul style="list-style-type: none"> Added chapter Reference design Added chapter Information for Ex protection 	February 2019
3.2	2.1.0	5.1	<ul style="list-style-type: none"> Updated pinout drawing, to match the drawing in the data sheet, note: no changes towards pin functionality (only adding the <i>RESERVED</i> pin text and corrected <i>/RST</i> to <i>/RTS</i>). 	June 2019
3.3	2.1.0	5.1	<ul style="list-style-type: none"> Updated label in chapter General labeling information Updated address of Division Wireless Connectivity & Sensors location 	October 2019
3.4	2.1.0	5.1	<ul style="list-style-type: none"> Updated the firmware update chapter. 	June 2020

Abbreviations and abstract

Abbreviation	Name	Description
ACK	Acknowledgement	Acknowledgement pattern confirming the reception of the transmitted data packet.
CCA	Clear Channel Assessment	Evaluation of channel access
CS	Checksum	
DC	Duty cycle	Transmission time in relation of one hour. 1% means, channel is occupied for 36 seconds per hour.
FIFO	First In First Out	Stack handling treatment
FSE	Field Sales Engineer	
0xhh [HEX]	Hexadecimal	All numbers beginning with 0x are stated as hexadecimal numbers. All other numbers are decimal.
HIGH	High signal level	
I/O	Input/output	Pinout description
LOW	Low signal level	
LPM	Low power mode	Operation mode for reduced power consumption.
LSB	Least significant bit	
MSB	Most significant bit	
PL	Payload	The real, non-redundant information in a frame/packet.
RF	Radio frequency	Describes everything relating to the wireless transmission.
SBW	Spy Bi-Wire	2 pin Flasher interface of MSP430
UART	Universal Asynchronous Receiver Transmitter	Universal Asynchronous Receiver Transmitter allows communicating with the module of a specific interface.
US	UserSettings	Any relation to a specific entry in the UserSettings is marked in a special font and can be found in the respective chapter.
VDD	Supply voltage	

Contents

1. Introduction	7
1.1. Operational description	7
1.2. Block diagram	8
1.3. Ordering information	8
2. Electrical specifications	9
2.1. Recommended operating conditions	9
2.2. Absolute maximum ratings	9
2.3. Power consumption	10
2.3.1. Static	10
2.4. Radio characteristics	10
2.5. Pin characteristics	11
3. Pinout	12
4. Quickstart	15
4.1. Minimal pin configuration	15
4.2. Power up	15
4.3. Quickstart example	15
5. Functional description	17
5.1. Operating modes	17
5.1.1. Switching from transparent to command mode	17
5.1.2. Switching from command to transparent mode	17
5.1.3. Transparent mode	17
5.1.3.1. /RTS signal, module busy	18
5.1.4. Command mode	19
5.1.4.1. /RTS signal, module busy	19
5.2. Adopting parameters to fit your application	19
5.3. Device addressing and wireless monitoring	19
6. Host connection	21
6.1. Serial interface: UART	21
7. The command interface	22
7.1. Data transfer & reception in the command mode	22
7.1.1. CMD_DATA_REQ	22
7.1.2. CMD_DATAEX_REQ	23
7.1.3. CMD_DATAEX_IND	24
7.1.4. CMD_DATARETRY_REQ	25
7.2. Requesting parameters and actions	25
7.2.1. CMD_FWRELEASE_REQ	25
7.2.2. CMD_SERIALNO_REQ	26
7.2.3. CMD_RESET_REQ	26
7.2.4. CMD_RSSI_REQ	26
7.3. Modification of volatile parameters	27
7.3.1. CMD_SET_MODE_REQ	28
7.3.2. CMD_SET_CHANNEL_REQ	28

7.3.3.	CMD_SET_DESTNETID_REQ	28
7.3.4.	CMD_SET_DESTADDR_REQ	29
7.4.	Modification of non-volatile parameters	29
7.4.1.	CMD_SET_REQ	29
7.4.2.	CMD_GET_REQ	31
8.	UserSettings - Module configuration values	33
8.1.	Difference between volatile and non-volatile settings	33
8.2.	Modifying the UserSettings	33
8.2.1.	Radio parameters	36
8.3.	UART_CTL0	36
8.4.	UART_CTL1	36
8.5.	UART_MCTL	36
8.6.	UART_BR0	37
8.7.	UART_BR1	37
8.8.	UART_PktMode	37
8.9.	UART_PktSize	37
8.10.	UART_RTSLimit	37
8.11.	UART_ETXChar	38
8.12.	UART_Timeout	38
8.13.	UART_DIDelay	38
8.14.	MAC_NumRetrys	38
8.15.	MAC_AddrMode	38
8.16.	MAC_DestNetID	39
8.17.	MAC_DestAddrLSB	39
8.18.	MAC_SourceNetID	39
8.19.	MAC_SourceAddrLSB	39
8.20.	MAC_ACKTimeout	39
8.21.	PHY_FIFOPrecharge	40
8.22.	PHY_PAPower	40
8.23.	PHY_DefaultChannel	41
8.24.	PHY_CCARSSILevel	41
8.25.	OpMode	41
8.26.	WOR_Prescaler	41
8.27.	WOR_Countdown	42
8.28.	WOR_RXOnTime	42
8.29.	CfgFlags	42
9.	Timing parameters	44
9.1.	Reset behaviour	44
9.1.1.	Power-on reset	44
9.1.2.	Reset via /RESET pin	44
9.2.	Wake-up from the sleep mode	45
9.3.	Latencies during data transfer / packet generation	45
10.	Radio parameters	46
10.1.	"H"-band	46
10.1.1.	Radio Equipment Directive	46
10.1.2.	Channel assignment	48

11. Battery powered operation	49
11.1. Active mode	49
11.2. Stand-by	49
11.3. WOR mode	49
11.4. Sleep mode	49
12. Custom firmware	50
12.1. Custom configuration of standard firmware	50
12.2. Customer specific firmware	50
12.3. Customer firmware	50
12.4. Contact for firmware requests	51
13. Firmware updates	52
13.1. Firmware flashing using the production interface	52
13.2. Update via ACC Software and UART	52
14. Firmware history	54
15. Design in guide	55
15.1. Advice for schematic and layout	55
15.2. Dimensioning of the micro strip antenna line	57
15.3. Antenna solutions	58
15.3.1. Wire antenna	59
15.3.2. Chip antenna	59
15.3.3. PCB antenna	59
15.3.4. Antennas provided by Würth Elektronik eiSos	60
15.3.4.1. 2600130011 - Helike - 169 MHz dipole antenna	60
15.3.4.2. 2600130041 - Herse - 434 MHz dipole antenna	61
15.3.4.3. 2600130081 - Hyperion-I - 868 MHz dipole antenna	62
15.3.4.4. 2600130082 - Hyperion-II - 868 MHz magnetic base antenna	63
15.3.4.5. 2600130021 - Himalia - 2.4 GHz dipole antenna	64
16. Reference design	65
16.1. Schematic	66
16.2. Layout	68
17. Manufacturing information	70
17.1. Moisture sensitivity level	70
17.2. Soldering	70
17.2.1. Reflow soldering	70
17.2.2. Cleaning	72
17.2.3. Other notations	72
17.3. ESD handling	72
17.4. Safety recommendations	73
18. Physical dimensions	74
18.1. Dimensions	74
18.2. Weight	74
18.3. Module drawing	74
18.4. Footprint	75

18.5. Antenna free area	76
19. Marking	77
19.1. Lot number	77
19.2. General labeling information	78
20. Information for Ex protection	79
21. References	80
22. Regulatory compliance information	81
22.1. Important notice EU	81
22.2. Conformity assessment of the final product	81
22.3. Exemption clause	81
22.4. EU Declaration of conformity	82
23. Important notes	84
23.1. General customer responsibility	84
23.2. Customer responsibility related to specific, in particular safety-relevant applications	84
23.3. Best care and attention	84
23.4. Customer support for product specifications	84
23.5. Product improvements	85
23.6. Product life cycle	85
23.7. Property rights	85
23.8. General terms and conditions	85
24. Legal notice	86
24.1. Exclusion of liability	86
24.2. Suitability in customer applications	86
24.3. Trademarks	86
24.4. Usage restriction	86
25. License terms	88
25.1. Limited license	88
25.2. Usage and obligations	88
25.3. Ownership	89
25.4. Firmware update(s)	89
25.5. Disclaimer of warranty	89
25.6. Limitation of liability	90
25.7. Applicable law and jurisdiction	90
25.8. Severability clause	90
25.9. Miscellaneous	90
A. Additional CRC8 Information	93
A.1. Example CRC8 Implementation	93
A.1.1. CRC8 Test Vectors	93
B. Example codes for host integration	94

1. Introduction

1.1. Operational description

The Thadeus module has been designed as a radio sub module for wireless communication between devices like controls, remote controls, sensors etc. It offers several addressing modes and relieves the host system of radio-specific tasks such as

- checksum calculation,
- address resolution, and
- repetition of unacknowledged telegrams.

It can be deployed wherever the wireless exchange of small data packets (up to 128 bytes) between two or more parties is required.

A serial interface (UART) whose data rate and format can be adjusted flexibly is available for communicating with the host system.

1.2. Block diagram

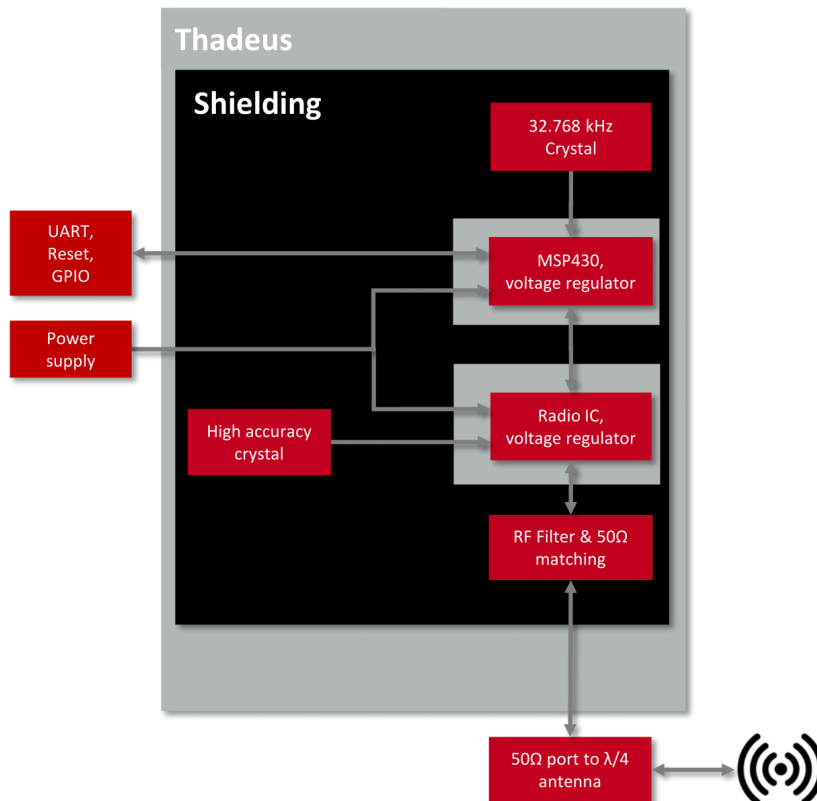

Figure 1: Block diagram

1.3. Ordering information

WE order code	Former order code	Description
2605031141000	AMB4426-TR	434 MHz proprietary module, Tape & Reel
2605031141009	AMB4426-DEV	434 MHz proprietary module development kit
2605039241001	AMB4426-EV	434 MHz proprietary module evaluation kit
2605066241001	AMB4465	434 MHz proprietary USB dongle

Table 1: Ordering information

2. Electrical specifications

As not otherwise stated measured on the evaluation board Thadeus-EV with $T=25\text{ }^{\circ}\text{C}$, $V_{\text{DDS}}=3\text{V}$, internal DC-DC converter active and $50\ \Omega$ conducted.

2.1. Recommended operating conditions

Description	Min.	Typ.	Max.	Unit
VCC	2.2	3.3	3.6	V
Temperature range	-30	20	85	$^{\circ}\text{C}$

Table 2: Recommended operating conditions

2.2. Absolute maximum ratings

Description	Min.	Typ.	Max.	Unit
VCC	-0.3		3.9	V
Voltage on any pin	-0.3		$V_{\text{CC}} + 0.3$, max 3.9	V
Input RF level			10	dBm

Table 3: Absolute maximum ratings

2.3. Power consumption



As a DC/DC voltage regulator is integrated, the current consumption is strongly depending on the supplied voltage level.



The transmit and receive currents are depending on the impedance matching, and therefore may vary depending on antenna selection and matching.



The stated values are representing the module current consumption for radio and active MCU. Not to be confused with only radio or only CPU core currents, as sometimes stated by others.



A stable power supply is indispensable to ensure valid operating conditions for the module.

2.3.1. Static

The current consumption is the sum of the CPU current and Radio TX or RX current in active modes. In sleep the CPU LPM3 and Radio Sleep currents were measured. Measurements were performed on multiple Thadeus-EV with $T=25\text{ }^{\circ}\text{C}$, $V_{\text{DDS}}=3.3\text{V}$, internal DC-DC converter active and $50\ \Omega$ conducted unless specified otherwise.

Description	Min	Typ.	Max	Unit
TX current consumption at max output power		34		mA
RX current consumption		24		mA
Radio + MCU Sleep, full RAM retention, UART 9600 baud ACLK		3		μA

Table 4: Power consumption

2.4. Radio characteristics

Conditions: Thadeus-EV, $T=25\text{ }^{\circ}\text{C}$, $V_{\text{CC}}=3.0\text{V}$, terminated unused module pads, $50\ \Omega$ conducted

Description	Min	Typ.	Max	Unit
Max output power			10	dBm
Input sensitivity, 1.2kbit radio		-107		dBm
Frequencies	433.75		434.75	MHz

Table 5: Radio characteristics

2.5. Pin characteristics

Property	Min	Typ.	Max	Unit
Pin input voltage for any digital I/O	-0.3		VCC + 0.3, max 3.9	V
Pin output current sunk by any digital I/O			6	mA
Pin output current sourced by any digital I/O			6	mA
Pin total output current sunk by sum of all I/Os			48	mA
Pin total output current sourced by sum of all I/Os			48	mA

Table 6: Pin characteristics

3. Pinout

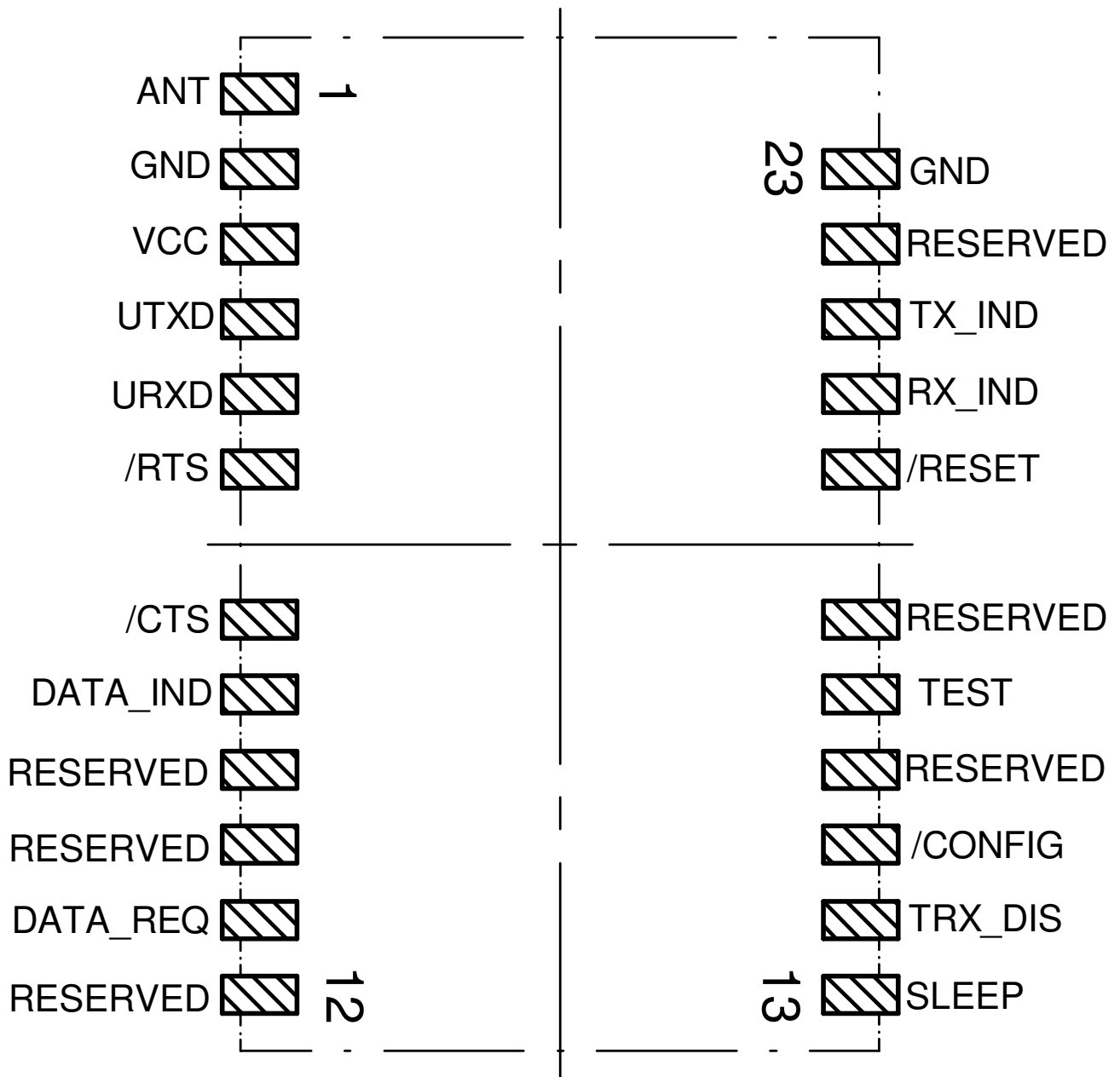

Figure 2: Pinout

No	Designation	I/O	Description
1	<i>ANT</i>		50Ω antenna connection
2	<i>GND</i>	Supply	Ground
3	<i>VCC</i>	Supply	Supply voltage
4	<i>UTXD</i>	Output	UART Module Output
5	<i>URXD</i>	Input	UART Module Input
6	<i>/RTS</i>	Output	Indicates if the module is busy, busy = HIGH level, idle = LOW level.
7	<i>/CTS</i>	Input	Connect to GND if not needed. In case the signal is HIGH, the transmission is suspended until it goes LOW again. (to enable this function see chapter CfgFlags)
8	<i>/DATA_IND</i>	Output	Goes LOW as soon as a valid frame is received via radio and remains LOW as long as the output via UART continues.
9	<i>Reserved</i>		Currently not used. These pins must be left open (do not connect).
10	<i>Reserved</i>		Currently not used. These pins must be left open (do not connect).
11	<i>/DATA_REQ</i>	Input	Connect to GND if not needed. In transparent mode it can be used to trigger sending of a packet (can be disabled in transparent mode, see CfgFlags).
12	<i>Reserved</i>		Currently not used. These pins must be left open (do not connect).
13	<i>SLEEP</i>	Input	Activates the Sleep Mode (on HIGH level). Connect to GND if not needed. The function can be disabled (see chapter CfgFlags).
14	<i>TRX_DIS</i>	Input	Switches the RF part off (on HIGH level) as long as no data is to be sent. Connect to GND if not needed. The function can be disabled (see chapter CfgFlags).
15	<i>/CONFIG</i>	Input	Operation mode switch on detection of a falling edge (between transparent and command mode). Connect to GND if not needed. The function can be disabled (see chapter CfgFlags).
16	<i>Reserved</i>		Currently not used. These pins must be left open (do not connect).
17	<i>Reserved</i>		Currently not used. These pins must be left open (do not connect).
18	<i>Reserved</i>		Currently not used. These pins must be left open (do not connect).

No	Designation	I/O	Description
19	<i>/RESET</i>	Input	Low level holds module in reset state. Apply a rising edge to reset the module (see chapter 9.1.2). Uses an internal pull-up resistor (typ. 47 k Ω).
20	<i>RX_IND</i>	Output	If the corresponding function is enabled (see chapter <i>CfgFlags</i>), <i>RX_IND</i> will go high during radio reception.
21	<i>TX_IND</i>	Output	If the corresponding function is enabled (see chapter <i>CfgFlags</i>), <i>TX_IND</i> will go high during radio transmission.
22	<i>Reserved</i>		Currently not used. These pins must be left open (do not connect).
23	<i>GND</i>	Supply	Ground

Table 7: Pinout



Frequent power cycling - especially in combination with slowly rising or falling supply voltages and non proper use of the */RESET* pin and reset timings - may lead to malfunction, in rare cases even to damage of the module respectively the embedded firmware.

The use of an external supply voltage supervisor is therefore highly recommended!

4. Quickstart

4.1. Minimal pin configuration

In the factory state, the modules are immediately ready for operation; the following pins are required in the minimal configuration: *VCC*, *GND*, *UTXD* and *URXD*. It is highly recommended to also connect */RTS* and */RESET* to the host.

In the default configuration, all module inputs (*SLEEP*, *TRX_DIS*, */CONFIG*, and */DATA_REQ*) are activated and must be connected to *GND*.

All reserved pins shall be left open.

If the module is to be connected to a PC, a level converter UART-TTL to RS-232 or USB-to-UART-TTL converter (e.g. FTDI TTL-232R-3V3) must be used. The user must ensure that the absolute max values of the module are adhered to.

Implementing connection to be able to perform a firmware update is strongly recommended otherwise you renounce the possibility of firmware updates with all possible consequences.

4.2. Power up

Recommended procedure for starting the module:

After supply voltage is applied to the module, the */RESET* pin shall be hold to LOW level for at least another Δt of at least 2ms after the *VCC* is stable to ensure a safe start-up. The module is ready when the pin */RTS* does not indicate module busy anymore.

If the module is used in a battery-powered system, using a matching reset-IC (or a discrete RC block for an according delay) is mandatory to ensure a correct power up. A reset-IC is required to ensure a stable behavior towards the battery getting empty and the voltage drops below or jitters around the required minimum operating voltage of *VCC*. Not implementing a proper reset method can lead to permanent damage of the module.

4.3. Quickstart example

Sending and receiving: Hello World

Connect your pair of modules, EV-boards or USB-sticks with the PC as explained in chapter 4.1. Please make sure you have a minimum distance of 3 meters between the two modules or devices to avoid over modulation. When short distances are needed, you could reduce the *PHY_PAPower* to a minimum.

When the connection to the PC is done, please use a terminal tool of your choice. For convenience we assume you selected the tool "hterm". Select the two corresponding COM ports and open them with a configuration of 9600 Baud, 8 Data bits, 1 Stop bit and Parity set to None.

The image shows a configuration interface for a terminal. It consists of four dropdown menus arranged horizontally. The first menu is labeled 'Baud' and has '9600' selected. The second menu is labeled 'Data' and has '8' selected. The third menu is labeled 'Stop' and has '1' selected. The fourth menu is labeled 'Parity' and has 'None' selected.

Enter the string "Hello World" into the input line of hterm and use the "ASend" button followed by pushing the "start" button to send the data once. Make sure the Type "ASC" of the transmit section of hterm is selected.

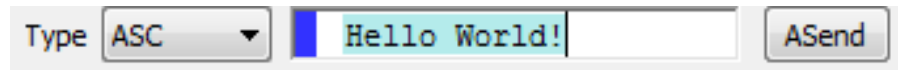

This data will be received by the second module and shows up as received data in the second hterm instance. You may send any string of size 1 to 128 characters from one module to the other. Two successive frames must be divided by a pause larger than `UART_Timeout`. Make sure the "Ascii" checkbox of the receive section of hterm is selected.

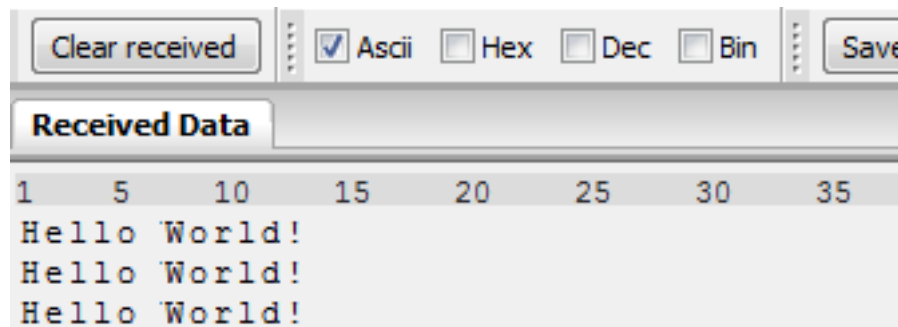

You just used the so called "transparent mode" of the modules to send your data. The address mode that was used is "0". Thus all radio frames are broadcasts that can be received by anyone listening with an Thadeus in default settings. The frame you send was generated using the timeout method.

Besides the transparent mode, that is suited for transparent data transmission, the so called "command mode" allows both, the module configuration and the data transmission, using a predefined command interface (see chapter 7).

5. Functional description

5.1. Operating modes

The device can be used in the following operating modes:

1. Transparent mode (transparent data transmission)
2. Command mode (module configuration and data transmission using the predefined command interface)

The operating mode after power-up can be configured by means of the `OpMode` parameter. By default, the module operates in transparent mode. Starting in the command mode, the module responds with a `CMD_SET_MODE_CNF` telegram.



Würth Elektronik eiSos highly recommends using the command mode.

5.1.1. Switching from transparent to command mode

The command mode can be entered by applying a falling edge on the `/CONFIG` pin or when a break signal is detected on the UART. A break condition exists if the RX input of the module is kept low for at least 10 more bits after an absent stop bit. Detection of both the falling edge on the `/CONFIG` pin and of the break signal can be disabled using the user setting `CfgFlags`.

The successful switchover is acknowledged by a `CMD_SET_MODE_CNF` telegram. The switchover can only occur when no data is being received by wireless transmission or UART interface (approximately 100 μ s after `/RTS` goes LOW and indicates module idle).

5.1.2. Switching from command to transparent mode

The transparent mode can be entered by applying a falling edge on the `/CONFIG` pin, by using the command `CMD_SET_MODE_REQ` or on detection of another break signal on the UART. Detection of both the falling edge on the `/CONFIG` pin and of the break signal can be disabled using the user setting `CfgFlags`.

The successful switchover is acknowledged by a `CMD_SET_MODE_CNF` telegram. The switchover can only occur when no data is being received by wireless transmission or UART interface (approximately 100 μ s after `/RTS` goes low and indicates readiness).

5.1.3. Transparent mode

In this mode, data is received via the serial interface and initially buffered. As soon as a specific condition is met (see table 8), the RF telegram is generated with a preamble, checksum, and address information (optional).

The number of characters transmitted in the wireless telegram in addition to the actual payload data depends on the selected addressing method and the data rate, and varies between 12 and 16 bytes (packet overhead).

If required, the RF telegram can be acknowledged by the recipient module (see chapter 8.14). If no acknowledgement is received, the telegram will automatically be repeated upon expiry of a timeout (see chapter 8.20).

The buffer size at the UART interface is 128 bytes, i.e. the maximum size of transmitted data packets is 128 bytes (payload data only, without packet overhead).

To initiate a radio transmission, several options are available, listed in the following table.

Start	Condition Description:	Dependent usersettings
Timeout	Transmission starts if no new character is detected within a configurable time period after receiving a character via UART. The timeout is reset every time a new character is received.	UART_Timeout UART_PktMode
End-Of-Text-Character	Transmission begins when the preconfigured character is transmitted via UART.	UART_PktMode UART_ETXChar
Fixed Packet Size	Transmission starts when the preconfigured number of bytes is reached in the RX buffer of the UART.	UART_PktSize UART_RTSLimit UART_PktMode
/Data Req Pin	The transmission starts as soon as a falling edge is detected on the /DATA_REQ pin.	CfgFlags

Table 8: Communication in transparent mode

The `UART_PktMode` parameter (see chapter 8.8) can be used to determine which of the listed combinations is to be used.



As long as the receiver module is busy sending characters via the serial interface, wireless data reception is not possible. For example, this effect is noticeable when sending a long data packet and subsequently a short data packet. In this case, the receiver module may still be busy sending the first packet via UART or SPI, and the second packet may be lost.

5.1.3.1. /RTS signal, module busy

/RTS signals a busy UART buffer which means, when /RTS is set HIGH, all new UART bytes are discarded. For example /RTS is set when any of the events in the prior chapter

has occurred in transparent mode.

The */RTS* also needs to be stable LOW for at least 5ms after a rising edge on the *RESET* pin of the module to indicate the module idle state.

5.1.4. Command mode

This operating mode primarily serves module configuration. The module acts as a slave and can be fully controlled by an external host using the commands of the command interface (see chapter 7).

It can also be used for wireless transmission of payload data providing a feedback dependent on the transmission success.

5.1.4.1. */RTS* signal, module busy

/RTS signalizes a busy UART buffer which means, when */RTS* is set HIGH, all new UART bytes are discarded. When this signal occurs in a UART command byte sequence send to the module, the command is discarded without user notification. The entire command needs to be resend by the host.

5.2. Adopting parameters to fit your application

The non-volatile parameters (see chapter 8) can only be changed by using the `CMD_SET_REQ` command or the ACC PC software. This command will need the following parameters:

- memory position of the parameter
- the new value that shall be applied to this parameter

Furthermore, there are volatile settings that can be accessed by explicit commands for each parameter. All available commands are introduced in chapter 7.

5.3. Device addressing and wireless monitoring

To connect several modules to networks or to send data to specific devices, the module supports the so called address mode. The corresponding user setting parameter `MAC_AddrMode` determines whether all modules in range, or all modules in a network or a single module with a fixed address is supposed to receive a certain message.

The address interpretation can be disabled with bit 7 in the `CfgFlags` ("packet sniffer mode"). A module configured in this way will receive all data packets and forward them to the serial interface, regardless of the addressing mode and sequence number. In sniffer mode, the module does not send any acknowledgment.

Settings like the module address can only be modified in the command mode. Thus we recommend to permanently operate in command mode by setting the user settings parameter `OpMode` to the value of 0x10 (16).

To use non-broadcast transmissions you need to adopt the following non-volatile settings:

- `MAC_AddrMode` (mode 1 or 2 should be used depending on the number of addresses you need)
- `MAC_SourceAddrLSB` as the local address for each device of your network, each member of the network will need an unique address. A value of 255 is invalid.
- `MAC_SourceNetID`, as the local network address for each device of your network, each member of the network will need an unique address. A value of 255 is invalid.

In command mode, the command `CMD_DATAEX_REQ`, that has the destination address as an own parameter, can be used to send your data to the specified address. A broadcast message can still be achieved when using 0xFF (255) for both destination address LSB and destination net ID.

6. Host connection

6.1. Serial interface: UART

The configuration in factory state of the UART is 9600 baud with data format of 8 data bits, no parity and 1 stop bit ("8n1"). The baud rate is adjusted by directly configuring the respective registers of the utilised microprocessor. In this way, the data rate can be adjusted from 300 to 115200 baud. The following data formats are supported:

- 8 bits
- No, even, or odd parity
- 1 stop bit



As the UART speed is derived from a digitally calibrated oscillator (DCO), there may be variations in UART data rate of up to $\pm 5\%$ over the entire temperature and supply voltage range.

When the watch crystal (ACLK) is used to provide the UART clock there may be variations of up to $\pm 47\%$ in UART data rate over the entire temperature and supply voltage range.

When using the PC program "ACC", common data rates can be selected directly via drop-down menu. With this selection, the registers mentioned above are automatically set to the optimum value.

Moreover, the "ACC" program also provides a dialog for calculating arbitrary baud rates.

The output of characters on the serial interface takes place with secondary priority. For this reason, short interruptions may occur between the output of individual characters (e.g. in the event of an interrupt).

7. The command interface

In the command mode, communication with the module occurs in the form of predefined commands. These commands must be sent in telegrams according to the format described in table 9.

Start signal	Command	Length	Payload	CS
0x02	Command value	Length value	Payload value(s)	CS value
1 Byte	1 Byte	1 Byte	Length value Bytes	1 Byte

Table 9: Telegram format in the command mode

Start signal: 0x02 (1 byte)

Command: One of the predefined commands according to section 0 (1 byte)

Length: Specifies the number of data in the following field of variable length and is limited to 128 in order to prevent buffer overflow (1 byte)

Payload: Variable number of data or parameters (N byte , maximum 128 byte, LSB first)

CS: XOR (exclusive-OR, "^")-assignment of the precedent fields, inclusive start signal, which means: $0x02 \wedge \text{Command} \wedge \text{Length} \wedge \text{Payload Byte0} \wedge \dots \wedge \text{Payload Byte N}$ (1 byte)



Host integration example codes for checksum calculation and command frame structure can be found in annex A and B, as well as in the *Wireless Connectivity SDK*.

Using a specific command, data can also be sent via RF, i.e. the module can be operated entirely in the command mode. Only this way quick channel changes, can be realized if no new signal is received for `UART_Timeout` milliseconds (see chapter 8.12) after receiving the start signal, the unit will wait for a new start signal.

7.1. Data transfer & reception in the command mode

7.1.1. CMD_DATA_REQ

This command serves the simple data transfer in the command mode. Transmission takes place on the configured channel (see chapter 7.3.2) to the previously parameterized destination and source addresses. All address bytes are taken from the volatile `RuntimeSettings`.

This command is especially suitable for transmission on a point-to-point connection. The number of payload data bytes is limited to 128 (in `MAC_AddrMode 0`) in order to prevent a buffer overflow.

Format (limit 128 payload data bytes):

Start signal	Command	Length	Payload	CS
0x02	0x00	1 Byte	Length Bytes	1 Byte

Response (CMD_DATA_CNF):

Start signal	Command	Length	Status	CS
0x02	0x40	0x01	1 Byte	1 Byte

Status:

0x00: ACK received, only possible if MAC_NumRetrys is not 0; see chapter 8.14

0x01: no ACK received or requested

7.1.2. CMD_DATAEX_REQ

This command serves data transfer in a network with several parties. Both the channel to use and the destination address (depending on the parameterized addressing mode) are specified along with the command and copied into the RuntimeSettings. The number of payload data bytes is limited to 127, 126 or 125 (depending on MAC_AddrMode) in order to prevent a buffer overflow.

The selected channel is used for all following receive operations, too.

Format in addressing mode 0 (limited to 127 payload data bytes):

Start signal	Command	Length	Channel	Payload	CS
0x02	0x01	1 Byte	1 Byte	(Length-1) Bytes	1 Byte

Format in addressing mode 1 (limited to 126 payload data bytes):

Start signal	Command	Length	Channel	Destination Address LSB	Payload	CS
0x02	0x01	1 Byte	1 Byte	1 Byte	(Length-2) Bytes	1 Byte

Format in addressing mode 2 (limited to 125 payload data bytes):

Start signal	Command	Length	Channel	Destination NetID	Destination Address LSB	Payload	CS
0x02	0x01	1 Byte	1 Byte	1 Byte	1 Byte	(Length-3) Bytes	1 Byte

Response:

Start signal	Command	Length	Status	CS
0x02	0x40	0x01	1 Byte	1 Byte

Status:

0x00: ACK received, only possible if 8.14 is not 0

0x01: no ACK received or requested

0x02: invalid channel selected

7.1.3. CMD_DATAEX_IND

This telegram indicates the reception of data bytes and represents the counterpart to the commands CMD_DATA_REQ and CMD_DATAEX_REQ. Apart from the RX field strength (RSSI value), this telegram also displays the source address stated in the received frame (depending on the parameterized addressing mode).

Format in addressing mode 0 (maximum 127 bytes payload data):

Start signal	Command	Length	Payload	RSSI	CS
0x02	0x81	1 Byte	Length Bytes	1 Byte	1 Byte

Format in addressing mode 1 (maximum 126 bytes payload data):

Start signal	Command	Length	Source Address LSB	Payload	RSSI	CS
0x02	0x81	1 Byte	1 Byte	(Length-2) Bytes	1 Byte	1 Byte

Format in addressing mode 2 (maximum 125 bytes payload data):

Start signal	Command	Length	Source NetID	Source Address LSB	Payload	RSSI	CS
0x02	0x81	1 Byte	1 Byte	1 Byte	(Length-3) Bytes	1 Byte	1 Byte

Response:

Start signal	Command	Length	Status	CS
0x02	0x40	1 Byte	1 Byte	1 Byte

Concerning the interpretation of the field strength, see chapter 7.2.4.

7.1.4. CMD_DATARETRY_REQ

This command relaunches the transmission of the data submitted earlier on with CMD_DATA_REQ or CMD_DATAEX_REQ. Thus, the data does not need to be transmitted again via the serial interface.

The buffered data is lost as soon as new data is sent via any UART command or data is received via any wireless transmission.

Format:

Start signal	Command	Length	CS
0x02	0x02	0x00	0x00

Response:

Start signal	Command	Length	Status	CS
0x02	0x40	1 Byte	1 Byte	1 Byte

Status:

0x00: ACK received, only possible if MAC_NumRetrys is not 0; see chapter 8.14

0x01: no ACK received or requested

0x03: no data available (e.g., overwritten by wireless data reception)

7.2. Requesting parameters and actions

This group includes all commands that will return read-only parameters or request actions in the module.

7.2.1. CMD_FWRELEASE_REQ

This command is used to get the firmware version of the module.

Format:

Start signal	Command	Length	CS
0x02	0x0C	0x00	0x00

Response

Start signal	Command	Length	FW-Version	CS
0x02	0x4C	0x03	3 Bytes	1 Byte

The major version number is returned as first byte of FW-Version, followed by the minor version number and the patch revision number.

7.2.2. CMD_SERIALNO_REQ

This command can be used to query the individual serial number of the module.
Format:

Start signal	Command	Length	CS
0x02	0x0B	0x00	0x09

Response

Start signal	Command 0x40	Length	Serial number	CS
0x02	0x4B	0x04	4 Bytes	1 Byte

The most significant byte, which identifies the product (product ID), is returned first. Followed by a 3 byte number in MSB first notation.

7.2.3. CMD_RESET_REQ

This command triggers a software reset of the module. The reset is performed after the acknowledgement is issued.

Format:

Start signal	Command	Length	CS
0x02	0x05	0x00	0x07

Response

Start signal	Command 0x40	Length	Status	CS
0x02	0x45	1 Byte	1 Byte	1 Byte

Status:

0x00: succes

7.2.4. CMD_RSSI_REQ

This command delivers the current RX level determined by the transceiver IC in the form of a two's complement.

Format:

Start signal	Command	Length	CS
0x02	0x0D	1 Byte	0x0F

Response:

Start signal	Command 0x40	Length	RSSI	CS
0x02	0x4D	1 Byte	1 Byte	1 Byte

The value obtained in this way delivers the RX level $RSSI_{dBm}$ in dBm as follows:

- Conversion of the hexadecimal value to a decimal $RSSI_{dec}$
- If $RSSI_{dec} \geq 128$: $RSSI_{dBm} = (RSSI_{dec} - 256) / 2 - RSSI_{Offset}$
- Otherwise ($RSSI_{dec} < 128$): $RSSI_{dBm} = RSSI_{dec} / 2 - RSSI_{Offset}$

The relation between the calculated value and the physical RX level in dBm is not linear across the entire operating range and is displayed in figure 3. The value of $RSSI_{Offset}$ is 74.

As can be seen in the following picture a saturation effect will occur on strong signals around -20dB and stronger. If you receive such strong signals please double-check that you obey the recommended minimum distance of 2 meters in between two stations or reduce the PHY_PAPower of the sending station accordingly.

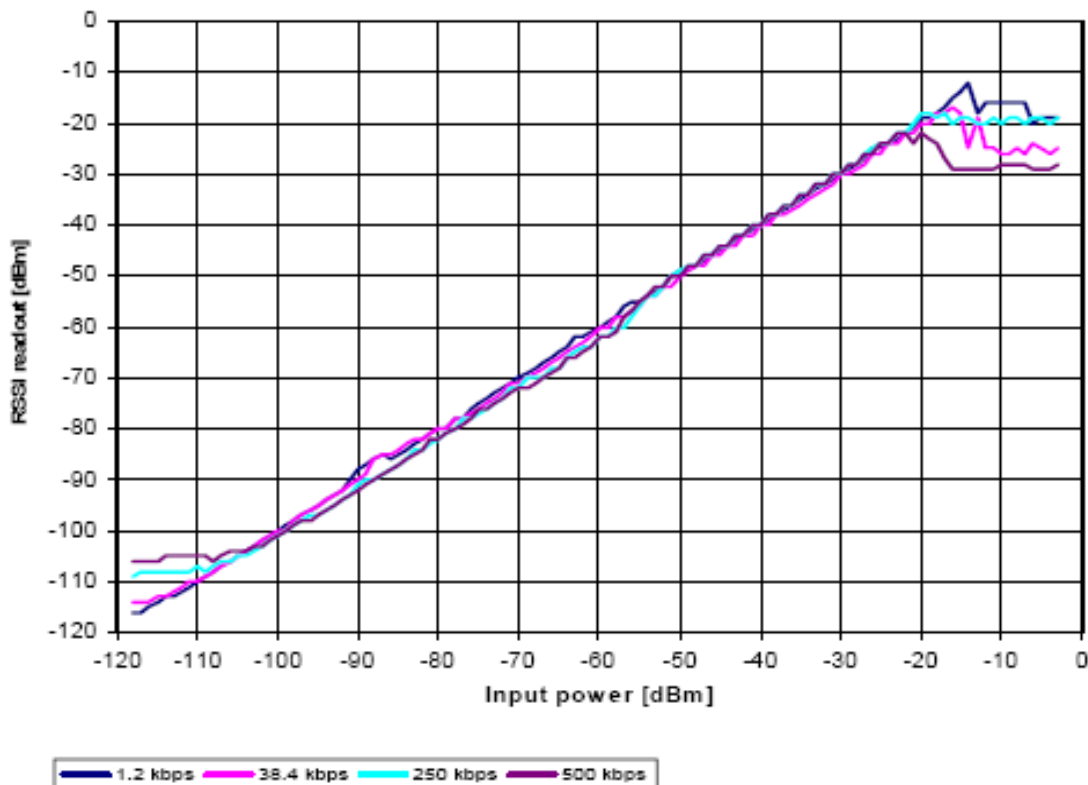

Figure 3: Relation between the RX level and the RSSI value read out for Thadeus

7.3. Modification of volatile parameters

This group contains all functions that will modify runtime settings while the module is running. These settings are all volatile and will be reset to defaults on a reset of the module.

7.3.1. CMD_SET_MODE_REQ

This command is used to toggle the operating mode, e.g. to exit the command mode (this is currently the only application).

Format:

Start signal	Command	Length	Desired operating mode	CS
0x02	0x04	1 Byte	1 Byte	1 Byte

Response:

Start signal	Command 0x40	Length	New operating mode	CS
0x02	0x44	1 Byte	1 Byte	1 Byte

The following operating modes are defined:

- Mode 0 (0x00): transparent data transfer
- Mode 16 (0x10): command mode

7.3.2. CMD_SET_CHANNEL_REQ

This command is used to select the radio channel for all following receive and transmit operations. Unlike the non-volatile parameter `PHY_DefaultChannel`, this is a volatile runtime parameter.

Format:

Start signal	Command	Length	Channel	CS
0x02	0x06	1 Byte	1 Byte	1 Byte

Response:

Start signal	Command 0x40	Length	New channel	CS
0x02	0x46	1 Byte	1 Byte	1 Byte

The number of the newly set channel is returned. If the permissible frequency range is exceeded, the lowest and highest permissible channels are configured and returned.

7.3.3. CMD_SET_DESTNETID_REQ

This command serves to configure the destination network ID in addressing mode 2. Unlike the non-volatile parameter `MAC_DestNetID` (see 0), this is a volatile runtime parameter.

Format:

Start signal	Command	Length	Destination network ID	CS
0x02	0x07	1 Byte	1 Byte	1 Byte

Response:

Start signal	Command 0x40	Length	Status	CS
0x02	0x47	1 Byte	1 Byte	1 Byte

Status:

0x00: success

7.3.4. CMD_SET_DESTADDR_REQ

This command serves to configure the destination address in addressing modes 1 and 2. Unlike the non-volatile parameter `MAC_DestAddrLSB` (see chapter 8.17), this is a volatile run-time parameter.

Format:

Start signal	Command	Length	Destination address	CS
0x02	0x08	1 Byte	1 Byte	1 Byte

Response:

Start signal	Command 0x40	Length	Status	CS
0x02	0x48	1 Byte	1 Byte	1 Byte

Status:

0x00: success

7.4. Modification of non-volatile parameters

The non-volatile parameters are also called user settings and are stored in a special flash location.

7.4.1. CMD_SET_REQ

This command enables direct manipulation of the parameters in the module's non-volatile memory. The respective parameters are accessed by means of the memory positions described in table 10.

You can modify individual or multiple consecutive parameters in the memory at the same time.

Parameters of 2 or more bytes have to be transferred LSB first.



The modified parameters only take effect after a restart of the module. This can be done by a `CMD_RESET_REQ` or using the `/RESET` pin.



The validity of the specified parameters is not verified by the application. Incorrect values can result in device malfunction up to a scenario where the firmware of the module needs to be re-flashed to get it operating again!



Any use of `CMD_SET_REQ` will consume one flash erase/write cycle. Flash erase/write cycles are limited through hardware (guaranteed minimum 100k cycles). For frequently changing parameters use the volatile parameters "RuntimeSettings", see chapter 7.3 .



To store the parameters in the flash memory of the module, the particular memory segment must be buffered into RAM, then to be erased entirely and then restored from RAM.

If a reset or VCC instability occurs during this procedure (e.g. due to supply voltage fluctuations), the entire memory area may be destroyed and the module can only be resurrected by means of a JTAG or Bootloader firmware update.

Recommended procedure: First verify the configuration of the module with `CMD_GET_REQ` and only apply a `CMD_SET_REQ` if required. Make sure the VCC is stable and no reset occurs during this procedure. It is recommended to hold the `TRX_DISABLE` pin HIGH to disable radio RX while using this command.

Format:

Start signal	Command	Length	Memory position	Number of bytes	Parameter	CS
0x02	0x09	1 Byte	1 Byte	1 Byte	(Length-2) Bytes	1 Byte

Response:

Start signal	Command	Length	Status	CS
0x02	0x49	1 Byte	1 Byte	1 Byte

Status:

0x00: succes

0x01: invalid memory position

0x02: invalid number of bytes to be written

Read and Write access to the memory area outside the parameters documented in table 10 are blocked. The memory position and the number of bytes are limited accordingly. Thus, the last memory position that can be read out is 79 (0x4F). And therefore the sum of Memory position plus Number of bytes must be smaller or equal to 80 (0x50).

Example 1: Setting the number of wireless retries (parameter MAC_NumRetrys, memory position 20 according to table 10): Format:

Start signal	Command	Length	Memory position	Number of bytes	MAC_NumRetrys	CS
0x02	0x09	0x03	0x14	0x01	1 Byte	1 Byte

Example 2: Setting the 3 registers for the baud rate configuration (UART_MCTL, UART_BR0 and UART_BR1). According to table 10, UART_MCTL has the memory position 2, UART_BR0 position 3, UART_BR1 position 4, so our start memory position needs to be set to 0x02 and the Number of bytes needs to be set to 0x03 resulting in the length being Number of bytes + 2 = 0x05:

Start signal	Command	Length	Memory position	Number of bytes	Payload	CS
0x02	0x09	0x05	0x02	0x03	3 Byte	1 Byte

7.4.2. CMD_GET_REQ

This command can be used to query individual or multiple non-volatile parameters (see chapter 8). The requested number of bytes from the specified memory position are returned.

You can query individual or multiple consecutive parameters in the memory at the same time.

Parameters of 2 or more bytes will be transmitted LSB first.

Format:

Start signal	Command	Length	Memory position	Number of bytes	CS
0x02	0x0A	1 Byte	1 Byte	1 Byte	1 Byte

Response:

Start signal	Command 0x40	Length	Memory position	Number of bytes	Parameter	CS
0x02	0x4A	1 Byte	1 Byte	1 Byte	(Length -2) Bytes	1 Byte

Read and Write access to the memory area outside the parameters documented in table 10 are blocked. The memory position and the number of bytes are limited accordingly. Thus, the last memory position that can be read out is 79 (0x4F). And therefore the sum of Memory position plus Number of bytes must be smaller or equal to 80 (0x50).

8. UserSettings - Module configuration values

8.1. Difference between volatile and non-volatile settings

The so-called UserSettings are stored permanently into the internal flash of the module. At start-up, these UserSettings are loaded as start values into the volatile settings ("RuntimeSettings"). Some of the RuntimeSettings can be modified by special commands (see chapter 7.3). These RuntimeSettings are lost and replaced by the UserSettings content when the module is restarted.



See chapters 7.3 and 7.4 for methods to change volatile and/or non-volatile settings.

The non-volatile UserSettings can be modified by means of specific commands in the configuration mode (`CMD_SET_REQ`) of the module. These parameters are stored permanently in the module's flash memory. All settings are described on the following pages. After changing those parameters, a reset will be necessary to make use of the new settings.



The validity of the specified parameters given with a `CMD_SET_REQ` is not verified. Incorrect values can result in device malfunction and may even result in the need of re-flashing the entire module firmware!

8.2. Modifying the UserSettings

The following chapters will give examples for the modification for many parameters using the commands `CMD_SET_REQ` and `CMD_GET_REQ`. The PC software ACC (version 3.4.3 or newer) can also be used to change non-volatile parameters.

Designation <small>Designation in ACC</small>	Summary	Permissible values	Default value	Memory position	Number of bytes
UART_CTL0 <small>Data format</small>	Control register for UART data format	See description	0	0	1
UART_CTL1	Control register for the baud rate (change only after consultation)	128	128	1	1
UART_MCTL <small>MCTL</small>	Control register for fine-adjusting the UART baud rate	0 - 255	146	2	1
UART_BR0 <small>BR0</small>	Prescaler for setting the baud rate (LSB)	0 - 255	65	3	1
UART_BR1 <small>BR1</small>	Prescaler for setting the baud rate (MSB)	0 - 255	3	4	1
UART_PktMode <small>Packetizing mode</small>	Selects the packet generation method	0 or 1	0	5	1
UART_PktSize <small>Packet size</small>	Number of characters for transmission start with set packet size	1 - 128	128	7	1
UART_RTSLimit <small>/RTS limit</small>	Number of received characters after which /RTS responds	1 - 128	112	8	1
UART_ETXChar <small>ETX character</small>	End-of-text character used to mark data packets; reception of this character triggers wireless transmission	0 - 255	10	9	1
UART_Timeout <small>Timeout</small>	Timeout after the last character before the data received via UART are transmitted via wireless transmission (in milliseconds)	2 - 65535	5	12	2
UART_DIDelay <small>Data indication delay</small>	Delay between the signalling by the /DATA_IND pin and the start of the output via UART	2 - 65535	0	14	2
MAC_NumRetrys <small>Retrys</small>	Number of wireless retries	0 - 255	0	20	1
MAC_AddrMode <small>Addressing mode</small>	Addressing mode to use	0, 1, 2	0	21	1
MAC_DestNetID <small>Dest. net ID</small>	Default destination network ID	0 - 255	0	24	1
MAC_DestAddrLSB <small>Dest. device address</small>	Default destination address (LSB)	0 - 255	0	25	1
MAC_SourceNetID <small>Local net ID</small>	Own network ID	0 - 254	0	28	1
MAC_SourceAddrLSB <small>Local device address</small>	Own address (LSB)	0 - 254	0	29	1

Table 10: Overview of non-volatile configuration parameters - Part 1

Designation Designation in ACC	Summary	Permissible values	Default value	Memory position	Number of bytes
MAC_ACKTimeout ACK timeout	Waiting time for wireless acknowledgement in milliseconds	2 - 65535	8	32	2
PHY_FIFOPrecharge FIFO precharge	Fill level of the FIFO before the transmission is launched (change only after consultation)	8 - 64	8	40	1
PHY_PAPower PA power	Transmission output; value range depends on RF configuration	0 - 255	195	41	1
PHY_DefaultChannel Default channel	Utilised wireless channel after reset; value range depends on RF configuration	0 - 255	10	42	1
PHY_CCARSSILevel CCA RSSI level	Field strength level for "channel free" detection (not yet supported)	0 - 255	0	43	1
OpMode Mode	Operating mode	0.16	0	60	
MSP_RSELx DCO resistor sel.	Start value for control loop DCO calibration after system reset (change only after consultation)	0 - 7	7	61	1
WOR_Prescaler Prescaler	Duration of a wake-up cycle for periodic wake-ups in WOR mode	0 - 65535	4096	64	2
WOR_Countdown Countdown	Number of wake-up cycles before waking up in WOR mode	0 - 65535	5	66	2
WOR_RXOnTime RX on time	Duration of RX readiness in WOR mode	0 - 65535	1000	68	2
CfgFlags Configuration flags (hex.)	Flags for setting various properties; see 9.27	0 - 65535	0	72	2
Synch1 Synch1	Synch word MSB for transceiver (change only after consultation!)	0 - 255	211	76	1
Synch0 Synch0	Synch word LSB for transceiver (change only after consultation)	0 - 255	145	77	1

Table 11: Overview of non-volatile configuration parameters - Part 2

8.2.1. Radio parameters

The radio parameters can only be set by the PC tool ACC or an adopted customer specific firmware. The `CMD_SET_REQ` cannot be used modify the radio parameters.

8.3. UART_CTL0

The UART data format can be configured with the help of the upper 5 bits in this register. The meaning of these bits is described in the following table.

Bit no.	Description
0 to 2 (0x0F)	Reserved, must always be set to 0.
3 (0x08)	Set bit 3 to 0 results in 1 stop bit use
4 (0x10)	Set bit 4 to 0 to use 8 data bits.
5 (0x20)	Set bit 5 to 0 to use LSB first bitorder in the data bits.
6 (0x40)	Ignored when bit 7 is 0. When bit 7 is set 1: if bit 6 is 1 <i>even parity</i> will be used, if bit 6 is 0 <i>odd parity</i> will be used.
7 (0x80)	When set 1 this bit enables the use of a parity bit as configured by bit 6.

Table 12: Setting the UART control configuration

8.4. UART_CTL1

This register selects the source for generating the UART clock speed. Currently, the recommended value is 128 (0x80), which will select the 8 MHz system clock.

Using a value of 64 (0x40) will set the low speed oscillator (ACLK, 32768 Hz) which can only be used if UART baud rates ≤ 9600 baud are configured. The `UART_BR0` and `UART_BR1` needs to be adopted accordingly to the clock.



Additional UART baudrate jitter will be introduced by selecting ACLK as UART clock source.

8.5. UART_MCTL

The registers `UART_MCTL`, `UART_BR0` and `UART_BR1` can be used to set the UART baud rate. Please use ACC to configure this parameter.

8.6. UART_BR0

The registers `UART_MCTL`, `UART_BR0` and `UART_BR1` can be used to set the UART baud rate. Please use ACC to configure this parameter.

8.7. UART_BR1

The registers `UART_MCTL`, `UART_BR0` and `UART_BR1` can be used to set the UART baud rate. Please use ACC to configure this parameter.

8.8. UART_PktMode

Selects the method used for generating packets for the transparent operating mode. Two methods have been implemented:

- Mode 0: Sends when
 - the timeout defined with `UART_Timeout` is reached, or
 - the number of bytes defined with `UART_PktSize` is reached, or
 - the transmission of the data is requested by means of the `/DATA_REQ` pin.
- Mode 1: Sends when
 - the character defined with `UART_ETXChar` is detected, or
 - the number of bytes defined with `UART_PktSize` has been received, or
 - the transmission of the data is requested by means of the `/DATA_REQ` pin.

8.9. UART_PktSize

Maximum number of bytes after which the wireless transmission of the data received via UART starts. Used in packet mode 0 as well as in packet mode 1. This setting does not apply to command mode.

8.10. UART_RTSLimit

Number of bytes after which the host system is prompted to interrupt the data transfer over `/RTS`. Necessary, because an immediate response to the `/RTS` signal may not take place (UART FIFO), depending on the host system. This setting does not apply to command mode.

8.11. UART_ETXChar

End-of-text character that triggers the transmission of the data received via UART. Only used in packet mode 1. During the wireless transmission, the ETX character is treated like a normal character. Not used in the command mode.

This setting does not apply to command mode.

8.12. UART_Timeout

Timeout in milliseconds after the last character has been received on UART before the wireless transmission of the data received via UART starts.

Only used in packet mode 0.

If there are no more new characters recognized after receiving the start character STX in command mode for this time, the characters received until then are discarded and the module waits for a new start character.

8.13. UART_DIDelay

This parameter determines the duration in milliseconds between the incoming radio frame data via pin `/DATA_IND` and outputting the data via the UART. This delay can be used to e.g. wake up a "sleeping" host system to prepare the receive of the data.

A rising edge will be set on a radio frame received.

8.14. MAC_NumRetrys

Determines the maximum number of wireless transmission retries. If this parameter is set to a value other than 0, the receiver module will automatically be prompted to send a wireless acknowledgment.

Retrys can only be used when `MAC_AddrMode` is > 0 and the address in the radio frame are not the broadcast address and/or NetID (0xFF, 255). All station must use the same `MAC_AddrMode`, channel and radio profile.

8.15. MAC_AddrMode

The following addressing modes are available:

1. No addressing (mode 0): Each module receives the transmitted RF telegram and delivers the received data to the host system via UART. No address information is transmitted in the wireless telegram. This mode does not allow retries as all frames are broadcast frames. The `MAC_NumRetrys` must be set 0 in this mode.
2. 1-byte address (mode 1): The receiving module will only deliver the data to the host system via UART if the destination address configured at the sender (`MAC_DestAddrLSB`, see chapter 8.17) corresponds to the source address (`MAC_SourceAddrLSB`, see chapter 8.19) or the address 255 (broadcast address) was specified as destination address. Both the destination address and the source address are transmitted in the wireless telegram (total = 2 bytes).

3. 2-byte address (mode 2): The receiving module will only deliver the data to the host system via UART if both the destination network ID and the destination address correspond to the source addresses (`MAC_SourceNetID` and `MAC_SourceAddrLSB`, see chapter 8.18 and chapter 8.19) or the broadcast address 255 was specified as destination address. A total of 4 bytes of address information are transmitted in the wireless telegram.



The receiver and transmitter modules must be operated in the same addressing mode!

8.16. `MAC_DestNetID`

Destination network address to use in addressing mode 2 after a reset. Can be modified with the command `CMD_SET_DESTNETID_REQ` at runtime (volatile). If the special broadcast ID and the broadcast address are set to 255, the sender will be received by all.

8.17. `MAC_DestAddrLSB`

Destination address to use in addressing modes 1 and 2 after a reset. Can be modified with the command `CMD_SET_DESTADDR_REQ` at runtime (volatile). If the special broadcast address is set to 255 (in the case of addressing mode 2, broadcast ID also 255), the sender will be received by all.

8.18. `MAC_SourceNetID`

Source network ID in addressing mode 2.

8.19. `MAC_SourceAddrLSB`

Source device address in addressing modes 1 and 2.

8.20. `MAC_ACKTimeout`

Time to wait for a wireless acknowledgment before a wireless retry is triggered. The values are automatically set in "ACC" depending on the configured RF data rate.

RF data rate	recommended ACK timeout
4.8 kbps	25 ms
10.0 kbps	15 ms
38.4 kbps	8 ms
76.8 kbps	6 ms
100.0 kbps	5 ms

Table 13: Recommended ACK timeouts

8.21. PHY_FIFOPrecharge

Number of bytes that are stored in the transceiver FIFO before actual transmission is launched. The values are automatically set in "ACC" depending on the configured RF data rate. The user shall not change this value.

8.22. PHY_PAPower

RF output of the module. The maximum permissible output depends on the utilized RF configuration. To select the maximum possible TX output power a value of 0xC0 must be set to this parameter. Other parameter values that are not listed in the table below shall not be used for this parameter.



Depending on the customer hardware, antenna, selected channel and frequency local regulations / restrictions regarding the TX output power must be adopted by the host to be compliant.

Due to the requirements for European conformity regarding EN 300 220-1 V3.1.1 and the claim regarding the Out Of Band Emissions the initial Output power is set to 9 dBm.



With 9 dBm or lower output power using the middle channel the Thadeus -EV with 2600130041 antenna conforms to the RED.

Using more than one channel the output power may have to be reduced further. Depending on the chosen antenna the output power may also be increased after the tx radiation characteristics has been measured in the end system.

More details on channel selection in chapter 10.

TX Output Power [dBm]	PHY_PA Power
Max. (+10)	0xC0
+9	0xC3
+7	0xC9
+5	0x84
0	0x60
-5	0x68
-10	0x26
-20	0x0E
-30	0x12

Table 14: CC1101 PA Mapping, 434 MHz

8.23. PHY_DefaultChannel

Determines the wireless channel to use after a module reset. See chapter 10.1 for details towards available channels.

8.24. PHY_CCARSSILevel

Function is not implemented to keep compatibility with older firmwares. The user shall not change this value.

8.25. OpMode

Operating mode to be used after power up. Modes 0 (transparent data transfer) and 16 (command mode) can be selected here.

We recommend using mode 16 (0x10) for better control of the module, rf configuration and detailed info upon sending success (CMD_DATA_CNF or CMD_DATAEX_CNF) and receiving frames (like sender address info, RSSI).



The use of the host driver included within the AMBER Pi SDK package requires command mode to be used.

8.26. WOR_Prescaler



WOR in this context describes a method of timer triggered sleep and wake-up with rx mode during the active time slots. It does not cover on demand rx at any received signal.

Defines the intervals in which the module in the Sleep Mode wakes up for a countdown (WOR_Countdown) until actual RX readiness. The interval (in seconds) is calculated as follows:

$$T_{\text{Prescaler}} = \frac{\text{WOR_Prescaler}}{4096}$$

8.27. WOR_Countdown

Number of prescaler cycles (countdown) until the module in the WOR mode enters the RX state. The duration until automatic RX readiness is calculated as follows:

$$T_{\text{WOR}} = \frac{\text{WOR_NumCycles} \cdot \text{WOR_Prescaler}}{4096}$$

8.28. WOR_RXOnTime

Defines the duration in milliseconds for which the module in the WOR is RX-ready after waking up before it returns to the Sleep Mode.

8.29. CfgFlags

16-bit bit field in which the use of individual pins or signals can be disabled. Table 15 presents a description of the respective flags. All reserved Flags / Bits shall be used as '0' to keep compatibility in case of future use.

Multiple bits or flags can be enabled by performing a ADD (+) operation between their values.

If e.g. LED's shall be enabled and the Sleep & Trx disable pin shall be disabled this would result in the following value for CfgFlags: $512 + 8 = 520 = 0x0208$. This results in 0x08 0x02 in LSB first notation.

Bit no.	Value	Description
0	0x0001 (1)	If this bit is set, the function of the <i>/CONFIG</i> pin will be disabled and will not cause the OpMode to toggle.
1	0x0002 (2)	If this bit is set, the function of the <i>/DATA_REQ</i> pin will be disabled. Only used in transparent mode.
2	0x0004 (4)	If this bit is set, the detection of the break signal on the UART interface will be suppressed and will not cause the OpMode to toggle.
3	0x0008 (8)	If this bit is set, the levels of the <i>SLEEP</i> and <i>TRX_DIS</i> pins will be ignored.
4	0x0010 (16)	Reserved
5	0x0020 (32)	If this bit is set, any character will be accepted as valid checksum in the command mode. Do not enable this option in a live system! This option is for debugging your implementation of the command interface only.
6	0x0000 (0)	Reserved, must be set '0'.
7	0x0080 (128)	Enables "sniffer mode". If this bit is set, the address will not be resolved and any packet will be forwarded to the module's UART.
8	0x0100 (256)	If this bit is set, the <i>/CTS</i> pin will be used by the UART. Make sure your host supports this function as this will block any module operation if not used properly.
9	0x0200 (512)	If this bit is set, the output for RF activity are active (for Rx and TX LED's).
10 to 15	0x0000 (0)	Reserved, must be set '0'.

Table 15: Configuration flags



Warning: If both bit 0 and bit 2 are set, the module will operate in the configured OpMode. If you are in transparent OpMode changing again is only possible with the "ACC" PC tool.

9. Timing parameters

9.1. Reset behaviour

Following a reset, a stable LOW level ($\geq 5\text{ms}$) on the $/RTS$ pin signals that the module is ready for operation. However, the level is only valid after the time required for the internal initialization of the processor.

After this initialisation, $/RTS$ is first set to high during boot-up of the module. After the boot-up the $/RTS$ changes back to LOW and indicates the module is ready to operate.



In transparent mode the host must implement proper startup detection by reading the $/RTS$ signal accordingly to ensure stable module operation. UART bytes can be lost when not handling the $/RTS$ accordingly.

9.1.1. Power-on reset

After setting the supply voltage and releasing the $/RESET$ pin. The time until the module is ready for operation can be up to 1000ms which depends on the boot up time and calibration time of the MUC oscillator (which depends on VCC level and temperature).

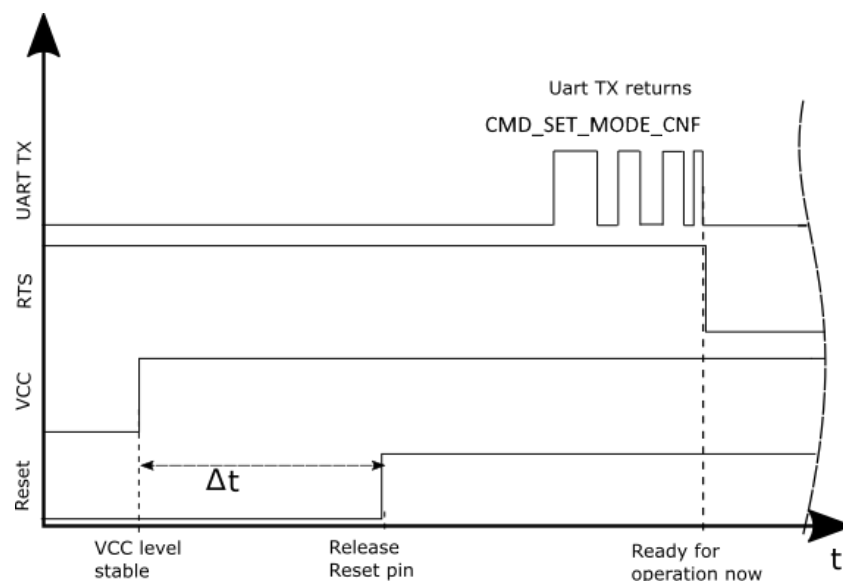

Figure 4: Command mode power up

9.1.2. Reset via $/RESET$ pin



This section applies only to a situation where the VCC is stable and the module was already running. Additional timings are needed when VCC was just applied to the module, see chapter 4.2

To force a module restart by means of the */RESET* pin, it must first be set to LOW for at least 10 ms (see figure 4, Δt).

After the pin is released, */RTS* will switch to high after around 100 μs to indicate module boot-up. During this time, the processor rate will be calibrated, which takes anywhere between 2 and 1000 ms depending on the supply voltage and temperature.

Recommended procedure: After the */RESET* pin is released, wait for falling edge on the */RTS* pin and then for a stable LOW level on the */RTS* pin and add an additional 100 μs before sending UART data to the module.

9.2. Wake-up from the sleep mode

The switch-over to and from the sleep mode is also acknowledged via the */RTS* signal.

Recommended procedure: After the *SLEEP* pin is released (to wake up the module), wait for a stable LOW level on the */RTS* pin and add an additional 100 μs before sending UART data to the module.

9.3. Latencies during data transfer / packet generation

The data transfer is always buffered, i.e. data received via UART is buffered in the module until a specific event (see table 6) occurs. Subsequently, the UART reception is interrupted (flow control with */RTS* signal), and the payload data is passed to the internal memory of the wireless transceiver (FIFO).

The wireless transmission starts as soon as the first data is available in the transceiver memory (which is after the whole packet was received on the module UART) during the ongoing wireless transmission, the remaining payload data is transmitted in chunks to the radio IC FIFO.

On the receiver side, the radio IC FIFO is read as soon as an incoming packet is detected. The whole received radio packet is checked for valid addressing and then transmitted via UART.

In combination with a suitable packet generation method, this procedure enables the minimization of the latencies resulting from buffering.

10. Radio parameters

The radio parameters (data rate, frequency range, etc.) can be configured with the PC program "ACC". Depending on the configured data rate, it can also be used to change additional parameters, e.g. MAC_ACKTimeout, PHY_DefaultChannel or PHY_FIFOPrecharge.

The following sections describe the permissible data rates and frequency ranges.

10.1. "H"-band

10.1.1. Radio Equipment Directive

In the factory state, the radio data rate of Thadeus is 38.4 kbps. This frequency band ranges from 433.050 to 434.790 MHz and requires adhering to a 10% duty cycle.

The Thadeus is pre certified to conform to the European Radio Equipment Directive. However, decisive for the conformity of the end-device is its radiated power. Besides others, this depends on the selected antenna, the wiring to the antenna and the quality of the power supply. Thus, the end-device manufacturer should verify the radiated power in any of his applications.

Due to this requirements for European conformity regarding EN 300 220-1 V3.1.1 and the claim regarding the out of band Emissions the initial output power is set to 9 dBm (Thadeus-EV with 2600130041 antenna). Higher power settings may be allowable depending on the radiated power in the end device and must be tested during the end system certification process. These measurements can also lead to the requirement for reducing the PHY_PAPower settings.



The Thadeus conformity measurements were performed with 50 Ohm conducted on the Thadeus-EV with an output power setting of 9 dBm. The test results refer to a 0 dB(i) antenna.

An important aspect to comply with the radio regulatory is to adhere to the requirements of the duty cycle (DC). The duty cycle is the ratio expressed as a percentage of the cumulative duration of transmissions T_{on_cum} within an observation interval T_{obs} .

$DC = (T_{on_cum} / T_{obs})_{F_{obs}}$ on an observation bandwidth F_{obs} .

Unless otherwise specified, T_{obs} is 1 hour and the observation bandwidth F_{obs} is the operational frequency band.



There are no mechanisms for constraining the duty cycle in the module firmware. The customer is fully responsible to adhere to the duty cycle restrictions.



To fulfill the EN 300 220:

From the configurable 50 kHz channel raster, depending on the radio profile or more precisely depending on the occupied channel width the user has to choose channels in the raster stated in the following table.

The frequency channels of the module can be selected from a 50 kHz grid. Not all channels are suitable and permissible, depending on the selected bandwidth, output power and antenna (RF profile, RF TX power and RF channel).

Due to the 50kHz grid the Band J cannot be used with this module. However, by means of a customer specific firmware and certification measurement the use of Band J can be enabled for specific radio profiles (resulting in no DC restrictions).

10.1.2. Channel assignment

Channel-Nr.	Frequency [MHz]	1.2 kbps	4.8 kbps	19.2 kbps	38.4 kbps	76.8 kbps	100 kbps
Occupied Channel Width		20kHz	100kHz	100kHz	100kHz	200kHz	200kHz
	<433.75	no	no	no	no	no	no
0	433.75	yes	yes	yes	yes	no	no
1	433.8	yes	*	*	*	*	*
2	433.85	yes	yes	yes	yes	yes	yes
3	433.90	yes	*	*	*	*	*
4	433.95	yes	yes	yes	yes	*	*
5	434.00	yes	*	*	*	*	*
6	434.05	yes	yes	yes	yes	yes	yes
7	434.10	yes	*	*	*	*	*
8	434.15	yes	yes	yes	yes	*	*
9	434.20	yes	*	*	*	*	*
10	434.25	yes	yes	yes	yes	yes	yes
11	434.30	yes	*	*	*	*	*
12	434.35	yes	yes	yes	yes	*	*
13	434.40	yes	*	*	*	*	*
14	434.45	yes	yes	yes	yes	yes	yes
15	434.50	yes	*	*	*	*	*
16	434.55	yes	yes	yes	yes	*	*
17	434.60	yes	*	*	*	*	*
18	434.65	yes	yes	yes	yes	yes	yes
19	434.70	yes	*	*	*	no	no
20	434.75	yes	no	no	no	no	no
	>434.75	no	no	no	no	no	no

Table 16: Recommended channel selection for "H" band, the default channel is shown in bold

"yes" means that the channel can be used and the use confirms to EN 300 220

"no" means that using the channel would not confirm to EN 300 220.

"*" means, that the channel in general is allowed, but the above mentioned channel spacing must be fulfilled

11. Battery powered operation

By using the pins *SLEEP* and *TRX_DISABLE* accordingly, the module can be set to various power-saving operating states. Table 17 presents an overview of the available options.

It is crucial for current consumption that the pins *SLEEP* and *TRX_DISABLE* are pulled to the required logic levels at any operation state by the host or be disabled by setting the *CfgFlags* parameter accordingly.

	<i>TRX_DISABLE</i> LOW level	<i>TRX_DISABLE</i> HIGH level
<i>SLEEP</i> LOW level	Active Mode , radio and UART communication possible	Standby , radio TX and UART possible, no radio RX
<i>SLEEP</i> HIGH level	WOR mode , module switches between active and standby mode, timer triggered	Sleep Mode , neither UART nor radio communication possible

Table 17: Power consumption control

All other pins must be configured and implemented as advised by table 7 to prevent leakage current.

11.1. Active mode

In this operating state, the module is permanently ready to receive and forward data via UART or wireless transmission. The module will only switch to one of the other power-saving modes after processing any pending data transmission, i.e. */RTS* must be low.

11.2. Stand-by

In this operating state, the module's transceiver is disabled. Wireless reception is not possible, but transmission of data via UART and radio is possible.

11.3. WOR mode

The module automatically (timer triggered) wakes up at configurable intervals and remains active to receive for a configurable time before it automatically (timer triggered) switches back to sleep mode. The corresponding *UserSettings* parameters are described in chapter 8.26 and following.

11.4. Sleep mode

This is the module state with the lowest power consumption. Radio IC and MUC UART communication are disabled and in sleep mode. The module switches to one of the other operating modes when it detects a falling edge on the *SLEEP* or *TRX_DISABLE* pin. Concerning the power consumption in this operating mode, refer to table 4.

12. Custom firmware

12.1. Custom configuration of standard firmware

The configuration of standard firmware includes adoption of the non-volatile User settings (see chapter 8) to customer requirements and creating a customized product on base of the standard product with a unique ordering number for a specific customer that needs this configuration.

For example if the UART baud rate shall be changed from the default value to another value. This variant will result in a customer exclusive module with a unique ordering number. This will also fix the firmware version to a specific and customer tested version and thus results in a customer exclusive module with a unique ordering number.

Further scheduled firmware updates of the standard firmware will not be applied to this variant automatically. Applying updates or further functions require a customer request and customer release procedure.

12.2. Customer specific firmware

A customer specific firmware may include "Custom configuration of standard firmware" plus additional options or functions and tasks that are customer specific and not part of the standard firmware.

Further scheduled firmware updates of the standard firmware will not be applied to this variant automatically. Applying updates or further functions require a customer request and customer release procedure.

This also results in a customer exclusive module with a unique ordering number.

An example for this level of customization are functions like host-less operation where the module will perform data generation (e.g. by reading a SPI or I²C sensor) and cyclic transmission of this data to a data collector while sleeping or being passive most of the time.

Also replacing UART with SPI as host communication interface is classified such a customer specific option.

Certification critical changes need to be re-evaluated by an external qualified measurement laboratory. These critical changes may occur when e.g. changing radio parameters, the channel access method, the duty-cycle or in case of various other functions and options possibly used or changed by a customer specific firmware.

12.3. Customer firmware

A customer firmware is a firmware written and tested by the customer himself or a 3rd party as a customer representative specifically for the hardware platform provided by a module.

This customer firmware (e.g. in form of a Intel hex file) will be implemented into the module's production process at our production side.

This also results in a customer exclusive module with a unique ordering number.

The additional information needed for this type of customer firmware, such as hardware specific details and details towards the development of such firmware are not available for the public and can only be made available to qualified customers.



The qualification(s) and certification(s) of the standard firmware cannot be applied to this customer firmware solution without a review and verification.

12.4. Contact for firmware requests

Please contact your local field sales engineer (FSE) or wireless-sales@we-online.com for quotes regarding this topics.

13. Firmware updates

All products will experience maintenance, security and/or feature updates from time to time. For the standard products these maintained via the PCN process.

Customers can request the creation of a customized product including a "firmware freeze" to ensure that they will receive their verified product even if the standard product is updated.

13.1. Firmware flashing using the production interface

Most Würth Elektronik eiSos wireless connectivity modules offer a production interface (e.g. JTAG, SWD, Spy-Bi-Wire) for module flash access. Depending on the product, this interface can be used by customers to erase the entire chip and install their own firmware.

Using the production interface is not intended to perform updates of Würth Elektronik eiSos standard product firmware.

Production firmware images and binary files for Würth Elektronik eiSos wireless connectivity modules are not publicly available.



Any certification, declaration, listing and qualification becomes invalid if the production interface is used by a customer. Some products, in their documentation, state exceptions to this invalidation under certain conditions.

Customers shall make the product specific firmware update interface available to their application. These methods will use a wired (UART, SPI, etc.) or wireless (Bluetooth® LE, Wi-Fi, etc.) communication interface of the module to allow updating the product's firmware. Details are described in the next sections.

13.2. Update via ACC Software and UART

Only the *UTDX*, *URXD* and *GND* signals are needed for this connection. A suitable adapter/-converter is required for a PC connection (e.g. the FTDI TTL-323R-3V3 UART to USB converter).



None of the module pins are 5V TTL compatible. Applying overvoltage to any pin may damage the hardware permanently. Ensure your levels are in the range of the electrical specification as shown in chapter 2



Users must make sure that their host is not accessing the Thadeus RX line (i.e. pulling it HIGH or LOW) as that will prevent ACC to access the module.

As long as our standard firmware is running on the module, it can be updated with the PC utility "ACC" via the serial interface. If the module is not directly connected to a PC, then at

least the UART should be made accessible, e.g. by means of a suitable connector.
ACC can be downloaded from the Würth Elektronik eiSos homepage: *ACC*.

14. Firmware history

Version 1.2.2 "Release"

- features added (*/CTS*-Pin; LED-Pins)
- internal Pull-Down resistors active at following inputs: */DATA_REQ*, *SLEEP*, *TRX_DIS*, */CONFIG*

Version 2.0.0 "Release"

- Thadeus: Updated the UserSettings to be CE-conform (i.e. *PHY_PAPower* was reduced)

Version 2.1.0 "Release"

- Ported to a newer compiler version
- Implemented newest errata updates

15. Design in guide

15.1. Advice for schematic and layout

For users with less RF experience it is advisable to closely copy the relating evaluation board with respect to schematic and layout, as it is a proven design. The layout should be conducted with particular care, because even small deficiencies could affect the radio performance and its range or even the conformity.

The following general advice should be taken into consideration:

- A clean, stable power supply is strongly recommended. Interference, especially oscillation can severely restrain range and conformity.
- Variations in voltage level should be avoided.
- LDOs, properly designed in, usually deliver a proper regulated voltage.
- Blocking capacitors and a ferrite bead in the power supply line can be included to filter and smoothen the supply voltage when necessary.



No fixed values can be recommended, as these depend on the circumstances of the application (main power source, interferences etc.).



The use of an external reset IC should be considered if one of the following points is relevant:



- The slew rate of the power supply exceeds the electrical specifications.
- The effect of different current consumptions on the voltage level of batteries or voltage regulators should be considered. The module draws higher currents in certain scenarios like start-up or radio transmit which may lead to a voltage drop on the supply. A restart under such circumstances should be prevented by ensuring that the supply voltage does not drop below the minimum specifications.
- Voltage levels below the minimum recommended voltage level may lead to misfunction. The /Reset pin of the module shall be held on LOW logic level whenever the VCC is not stable or below the minimum operating Voltage.
- Special care must be taken in case of battery powered systems.

- Elements for ESD protection should be placed on all pins that are accessible from the outside and should be placed close to the accessible area. For example, the RF-pin is accessible when using an external antenna and should be protected.
- ESD protection for the antenna connection must be chosen such as to have a minimum effect on the RF signal. For example, a protection diode with low capacitance such as the 8231606A or a 68 nH air-core coil connecting the RF-line to ground give good results.
- Placeholders for optional antenna matching or additional filtering are recommended.
- The antenna path should be kept as short as possible.



Again, no fixed values can be recommended, as they depend on the influencing circumstances of the application (antenna, interferences etc.).

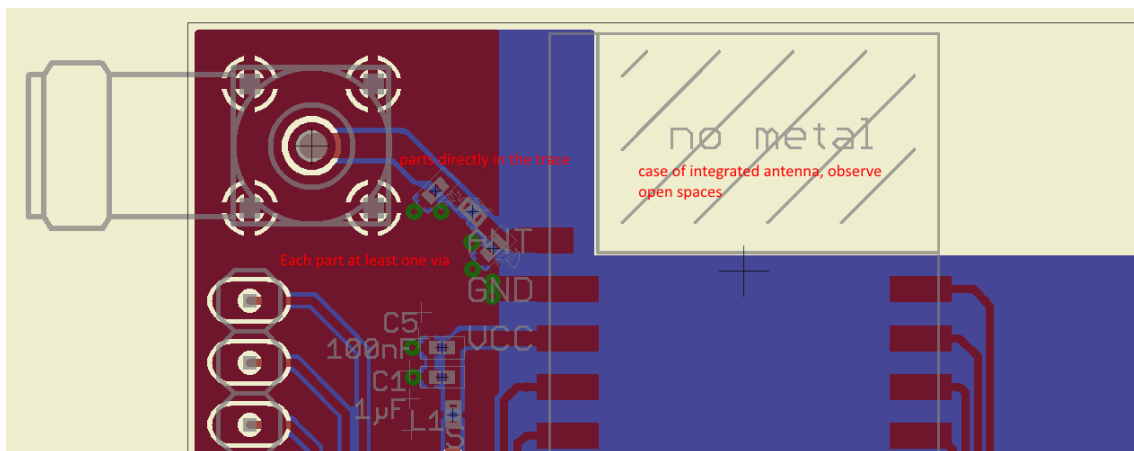

Figure 5: Layout

- To avoid the risk of short circuits and interference there should be no routing underneath the module on the top layer of the baseboard.
- On the second layer, a ground plane is recommended, to provide good grounding and shielding to any following layers and application environment.
- In case of integrated antennas it is required to have areas free from ground. This area should be copied from the evaluation board.
- The area with the integrated antenna must overlap with the carrier board and should not protrude, as it is matched to sitting directly on top of a PCB.
- Modules with integrated antennas should be placed with the antenna at the edge of the main board. It should not be placed in the middle of the main board or far away from the edge. This is to avoid tracks beside the antenna.

- Filter and blocking capacitors should be placed directly in the tracks without stubs, to achieve the best effect.
- Antenna matching elements should be placed close to the antenna / connector, blocking capacitors close to the module.
- Ground connections for the module and the capacitors should be kept as short as possible and with at least one separate through hole connection to the ground layer.
- ESD protection elements should be placed as close as possible to the exposed areas.

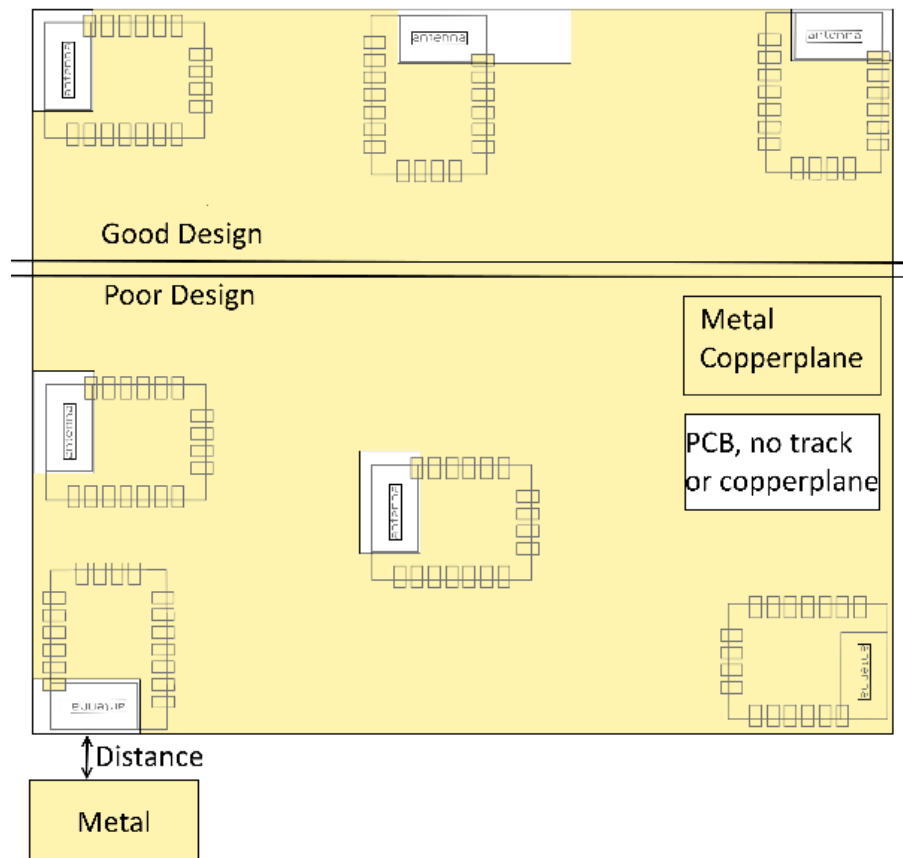

Figure 6: Placement of the module with integrated antenna

15.2. Dimensioning of the micro strip antenna line

The antenna track has to be designed as a 50Ω feed line. The width W for a micro strip can be calculated using the following equation:

$$W = 1.25 \times \left(\frac{5.98 \times H}{e^{\frac{50 \times \sqrt{\epsilon_r + 1.41}}{87}}} - T_{met} \right) \quad (1)$$

Example:

A FR4 material with $\epsilon_r = 4.3$, a height $H = 1000 \mu\text{m}$ and a copper thickness of $T_{met} = 18 \mu\text{m}$

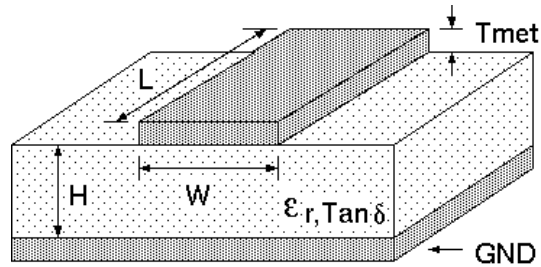

Figure 7: Dimensioning the antenna feed line as micro strip

will lead to a trace width of $W \sim 1.9$ mm. To ease the calculation of the micro strip line (or e.g. a coplanar) many calculators can be found in the internet.

- As rule of thumb a distance of about $3 \times W$ should be observed between the micro strip and other traces / ground.
- The micro strip refers to ground, therefore there has to be the ground plane underneath the trace.
- Keep the feeding line as short as possible.

15.3. Antenna solutions

There exist several kinds of antennas, which are optimized for different needs. Chip antennas are optimized for minimal size requirements but at the expense of range, PCB antennas are optimized for minimal costs, and are generally a compromise between size and range. Both usually fit inside a housing.

Range optimization in general is at the expense of space. Antennas that are bigger in size, so that they would probably not fit in a small housing, are usually equipped with a RF connector. A benefit of this connector may be to use it to lead the RF signal through a metal plate (e.g. metal housing, cabinet).

As a rule of thumb a minimum distance of $\lambda/10$ (which is 3.5 cm @ 868 MHz and 1.2 cm @ 2.44 GHz) from the antenna to any other metal should be kept. Metal placed further away will not directly influence the behavior of the antenna, but will anyway produce shadowing.



Keep the antenna away from large metal objects as far as possible to avoid electromagnetic field blocking.



The choice of antenna might have influence on the safety requirements.

In the following chapters, some special types of antenna are described.

15.3.1. Wire antenna

An effective antenna is a $\lambda/4$ radiator with a suiting ground plane. The simplest realization is a piece of wire. It's length is depending on the used radio frequency, so for example 8.6 cm 868.0 MHz and 3.1 cm for 2.440 GHz as frequency. This radiator needs a ground plane at its feeding point. Ideally, it is placed vertically in the middle of the ground plane. As this is often not possible because of space requirements, a suitable compromise is to bend the wire away from the PCB respective to the ground plane. The $\lambda/4$ radiator has approximately 40 Ω input impedance, therefore matching is not required.

15.3.2. Chip antenna

There are many chip antennas from various manufacturers. The benefit of a chip antenna is obviously the minimal space required and reasonable costs. However, this is often at the expense of range. For the chip antennas, reference designs should be followed as closely as possible, because only in this constellation can the stated performance be achieved.

15.3.3. PCB antenna

PCB antenna designs can be very different. The special attention can be on the miniaturization or on the performance. The benefits of the PCB antenna are their small / not existing (if PCB space is available) costs, however the evaluation of a PCB antenna holds more risk of failure than the use of a finished antenna. Most PCB antenna designs are a compromise of range and space between chip antennas and connector antennas.

15.3.4. Antennas provided by Würth Elektronik eiSos

15.3.4.1. 2600130011 - Helike - 169 MHz dipole antenna



Figure 8: 169 MHz dipole-antenna

Specification	Value
Frequency range [MHz]	169
Impedance [Ω]	50
VSWR	≤ 2.1
Gain [dBi]	1
Dimensions (L x d) [mm]	320 x 15
Weight [g]	42
Connector	SMA plug
Operating Temp. [$^{\circ}\text{C}$]	-40 – +85



This antenna requires a ground plane which will influence the electrical parameters.

15.3.4.2. 2600130041 - Herse - 434 MHz dipole antenna



Figure 9: 434 MHz dipole-antenna

Specification	Value
Frequency range [MHz]	433
Impedance [Ω]	50
VSWR	≤ 1.5
Polarization	Vertical
Radiation	Omni
Gain [dBi]	0
Antenna Cover	TPEE
Dimensions (L x d) [mm]	90 x 12
Weight [g]	9.6
Connector	SMA plug
Operating Temp. [$^{\circ}\text{C}$]	-40 – +80



This antenna requires a ground plane which will influence the electrical parameters.

15.3.4.3. 2600130081 - Hyperion-I - 868 MHz dipole antenna



Figure 10: 868 MHz dipole-antenna

Ideally suited for applications where no ground plane is available.



The 2600130081 antenna can be also used for 902MHz - 928MHz range.

Specification	Value
Center frequency [MHz]	868
Frequency range [MHz]	853 – 883
Wavelength	0.5 wave
VSWR	≤ 2.0
Impedance [Ω]	50
Connector	SMA (Male)
Dimensions (L x d) [mm]	142 x 10
Peak gain [dBi]	-2.3
Operating temp. [$^{\circ}\text{C}$]	-30 – +80

15.3.4.4. 2600130082 - Hyperion-II - 868 MHz magnetic base antenna

Well suited for applications where the RF is lead through a metal wall that could serve as ground plane to the antenna.



Figure 11: 868 MHz magnet foot antenna with 1.5 m antenna cable



The 2600130082 is a kind of $\lambda/4$ radiator and therefore needs a ground plane at the feeding point.

Specification	Value
Frequency range [MHz]	824 – 894
VSWR	≤ 2.0
Polarisation	Vertical
Impedance [Ω]	50 ± 5
Connector	SMA (Male)
Dimensions (L x d) [mm]	89.8 x 27
Weight [g]	50 ± 5
Operating temp. [$^{\circ}\text{C}$]	-30 – +60

15.3.4.5. 2600130021 - Himalia - 2.4 GHz dipole antenna



Figure 12: 2.4 GHz dipole-antenna

Due to the fact, that the antenna has dipole topology there is no need for an additional ground plane. Nevertheless the specification was measured edge mounted and 90° bent on a 100 x 100 mm ground plane.

Specification	Value
Frequency range [GHz]	2.4 – 2.5
Impedance [Ω]	50
VSWR	$\leq 2:1$
Polarization	Linear
Radiation	Omni-Directional
Peak Gain [dBi]	2.8
Average Gain [dBi]	-0.6
Efficiency	85 %
Dimensions (L x d) [mm]	83.1 x 10
Weight [g]	7.4
Connector	SMA plug
Operating temp. [$^{\circ}\text{C}$]	-40 – +80

Special care must be taken for FCC certification when using this external antenna to fulfill the requirement of permanently attached antenna or unique coupling for example by using the certified dipole antenna in a closed housing, so that only through professional installation it is possible to remove it.

16. Reference design

Thadeus was tested and certified on the corresponding Thadeus evaluation board. For the compliance with the EU directive 2014/53/EU Annex I, the evaluation board serves as reference design.

This is no discrepancy due to the fact that the evaluation board itself does not fall within the scope of the EU directive 2014/53/EU Annex I as the module is tested on the evaluation board, which is also the recommended use.

Further information concerning the use of the evaluation board can be found in the manual of the Thadeus evaluation board.

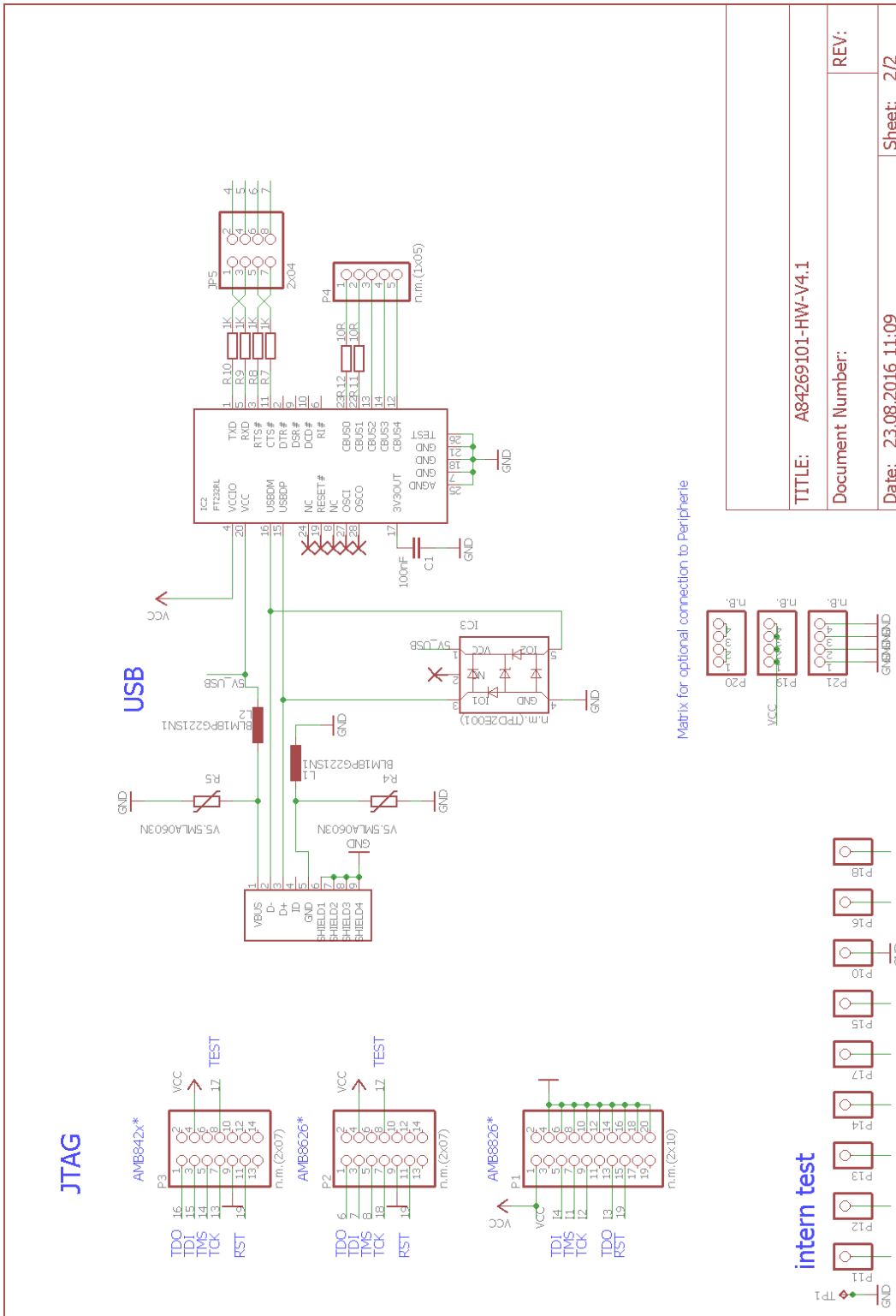

16.2. Layout

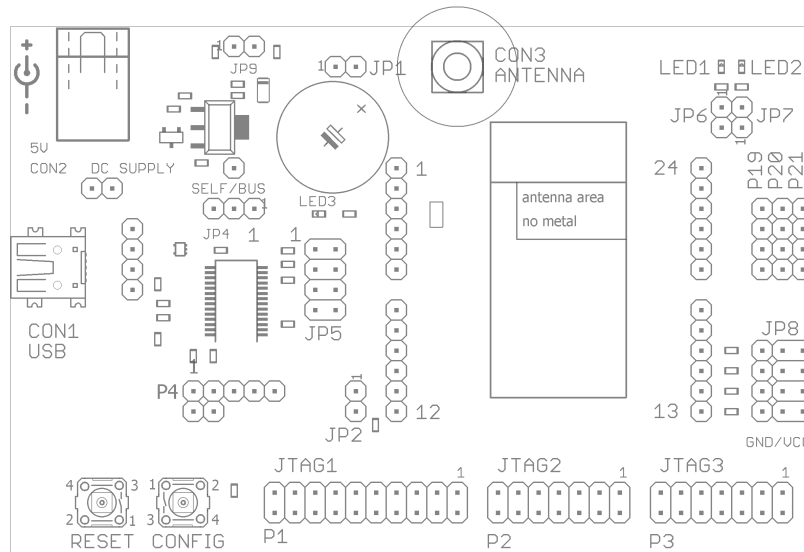

Figure 13: Assembly diagram

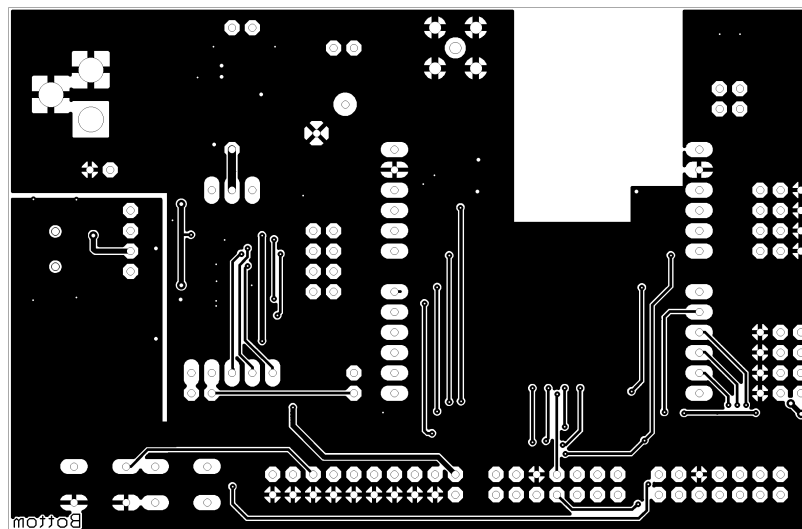
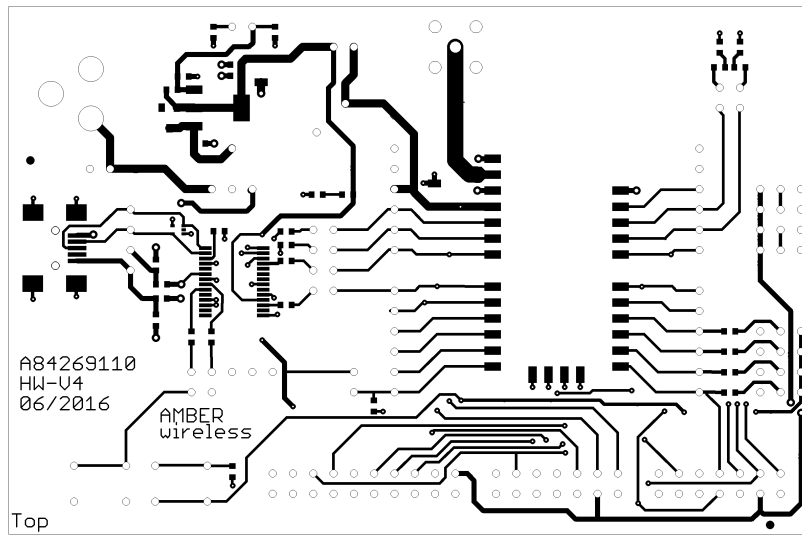

Figure 14: Top and Bottom Layer

17. Manufacturing information

17.1. Moisture sensitivity level

This wireless connectivity product is categorized as JEDEC Moisture Sensitivity Level 3 (MSL3), which requires special handling.

More information regarding the MSL requirements can be found in the IPC/JEDEC J-STD-020 standard on www.jedec.org.

More information about the handling, picking, shipping and the usage of moisture/reflow and/or process sensitive products can be found in the IPC/JEDEC J-STD-033 standard on www.jedec.org.

17.2. Soldering

17.2.1. Reflow soldering

Attention must be paid on the thickness of the solder resist between the host PCB top side and the modules bottom side. Only lead-free assembly is recommended according to JEDEC J-STD020.

Profile feature		Value
Preheat temperature Min	$T_{S \text{ Min}}$	150°C
Preheat temperature Max	$T_{S \text{ Max}}$	200°C
Preheat time from $T_{S \text{ Min}}$ to $T_{S \text{ Max}}$	t_S	60 - 120 seconds
Ramp-up rate (T_L to T_P)		3°C / second max.
Liquidous temperature	T_L	217°C
Time t_L maintained above T_L	t_L	60 - 150 seconds
Peak package body temperature	T_P	see table below
Time within 5°C of actual peak temperature	t_P	20 - 30 seconds
Ramp-down Rate (T_P to T_L)		6°C / second max.
Time 20°C to T_P		8 minutes max.

Table 18: Classification reflow soldering profile, Note: refer to IPC/JEDEC J-STD-020E

Package thickness	Volume mm ³ <350	Volume mm ³ 350-2000	Volume mm ³ >2000
< 1.6mm	260 °C	260 °C	260 °C
1.6mm - 2.5mm	260 °C	250 °C	245 °C
> 2.5mm	250 °C	245 °C	245 °C

Table 19: Package classification reflow temperature, PB-free assembly, Note: refer to IPC/-JEDEC J-STD-020E

It is recommended to solder this module on the last reflow cycle of the PCB. For solder paste use a LFM-48W or Indium based SAC 305 alloy (Sn 96.5 / Ag 3.0 / Cu 0.5 / Indium 8.9HF / Type 3 / 89%) type 3 or higher.

The reflow profile must be adjusted based on the thermal mass of the entire populated PCB, heat transfer efficiency of the reflow oven and the specific type of solder paste used. Based on the specific process and PCB layout the optimal soldering profile must be adjusted and verified. Other soldering methods (e.g. vapor phase) have not been verified and have to be validated by the customer at their own risk. Rework is not recommended.

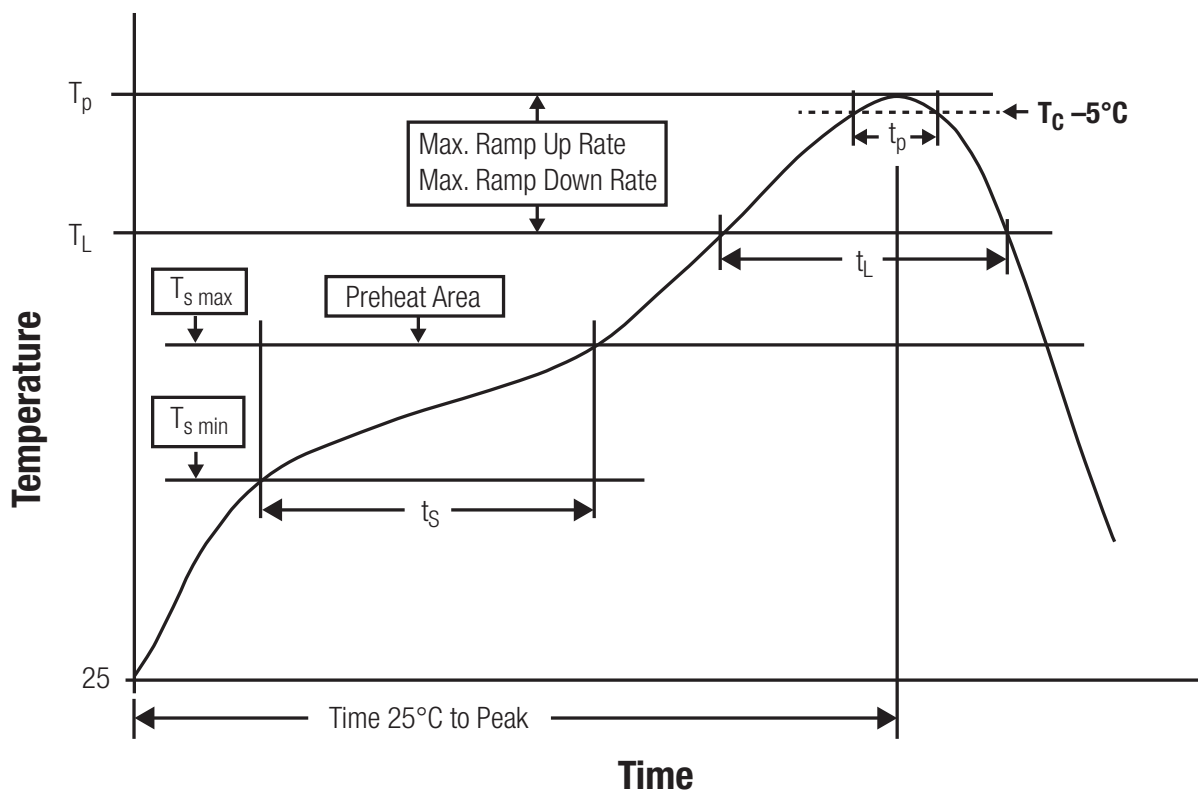

Figure 15: Reflow soldering profile

After reflow soldering, visually inspect the board to confirm proper alignment

17.2.2. Cleaning

Do not clean the product. Any residue cannot be easily removed by washing. Use a "no clean" soldering paste and do not clean the board after soldering.

- Do not clean the product with water. Capillary effects can draw water into the gap between the host PCB and the module, absorbing water underneath it. If water is trapped inside, it may short-circuit adjoining pads. The water may also destroy the label and ink-jet printed text on it.
- Cleaning processes using alcohol or other organic solvents may draw solder flux residues into the housing, which won't be detected in a post-wash inspection. The solvent may also destroy the label and ink-jet printed text on it.
- Do not use ultrasonic cleaning as it will permanently damage the part, particularly the crystal oscillators.

17.2.3. Other notations

- Conformal coating of the product will result in the loss of warranty. The RF shields will not protect the part from low-viscosity coatings.
- Do not attempt to improve the grounding by forming metal strips directly to the EMI covers or soldering on ground cables, as it may damage the part and will void the warranty.
- Always solder every pad to the host PCB even if some are unused, to improve the mechanical strength of the module.
- The part is sensitive to ultrasonic waves, as such do not use ultrasonic cleaning, welding or other processing. Any ultrasonic processing will void the warranty.

17.3. ESD handling

This product is highly sensitive to electrostatic discharge (ESD). As such, always use proper ESD precautions when handling. Make sure to handle the part properly throughout all stages of production, including on the host PCB where the module is installed. For ESD ratings, refer to the module series' maximum ESD section. For more information, refer to the relevant chapter 2. Failing to follow the aforementioned recommendations can result in severe damage to the part.

- the first contact point when handling the PCB is always between the local GND and the host PCB GND, unless there is a galvanic coupling between the local GND (for example work table) and the host PCB GND.
- Before assembling an antenna patch, connect the grounds.
- While handling the RF pin, avoid contact with any charged capacitors and be careful when contacting any materials that can develop charges (for example coaxial cable with around 50-80 pF/m, patch antenna with around 10 pF, soldering iron etc.)

- Do not touch any exposed area of the antenna to avoid electrostatic discharge. Do not let the antenna area be touched in a non ESD-safe manner.
- When soldering, use an ESD-safe soldering iron.

17.4. Safety recommendations

It is your duty to ensure that the product is allowed to be used in the destination country and within the required environment. Usage of the product can be dangerous and must be tested and verified by the end user. Be especially careful of:

- Use in areas with risk of explosion (for example oil refineries, gas stations).
- Use in areas such as airports, aircraft, hospitals, etc., where the product may interfere with other electronic components.

It is the customer's responsibility to ensure compliance with all applicable legal, regulatory and safety-related requirements as well as applicable environmental regulations. Disassembling the product is not allowed. Evidence of tampering will void the warranty.

- Compliance with the instructions in the product manual is recommended for correct product set-up.
- The product must be provided with a consolidated voltage source. The wiring must meet all applicable fire and security prevention standards.
- Handle with care. Avoid touching the pins as there could be ESD damage.

Be careful when working with any external components. When in doubt consult the technical documentation and relevant standards. Always use an antenna with the proper characteristics.



Würth Elektronik eiSos radio modules with high output power of up to 500 mW, as for example the radio module Thebe-II, generate a high amount of warmth while transmitting. The manufacturer of the end device must take care of potentially necessary actions for his application.

18. Physical dimensions

18.1. Dimensions

Dimensions
17 x 27 x 4 mm

Table 20: Dimensions

18.2. Weight

Weight
~3 g

Table 21: Weight

18.3. Module drawing

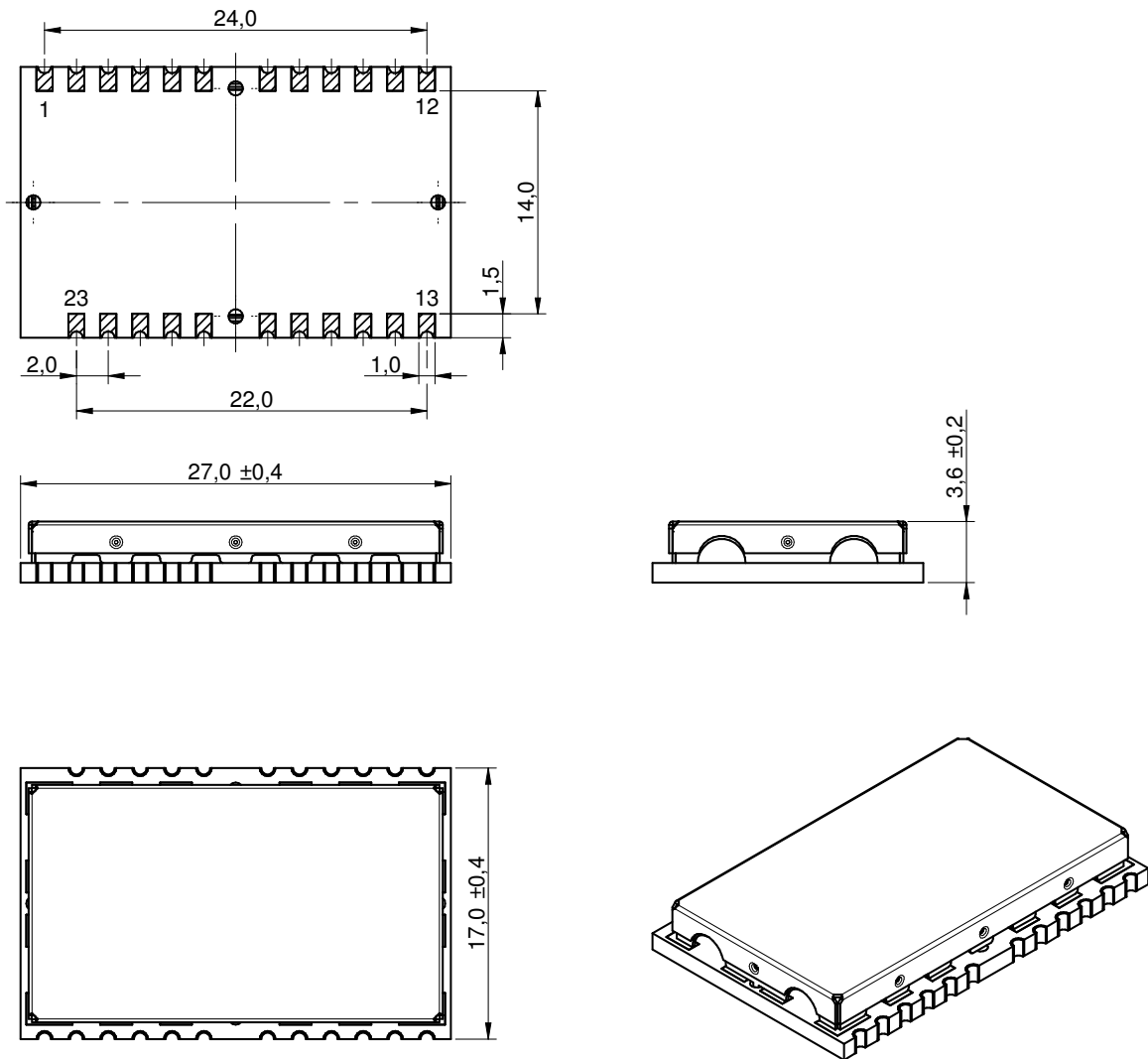

Figure 16: Module dimensions [mm]

18.4. Footprint



Due to the high risk of a short between VCC and GND, a clearance of 14 mm between the opposite pads has to be considered!

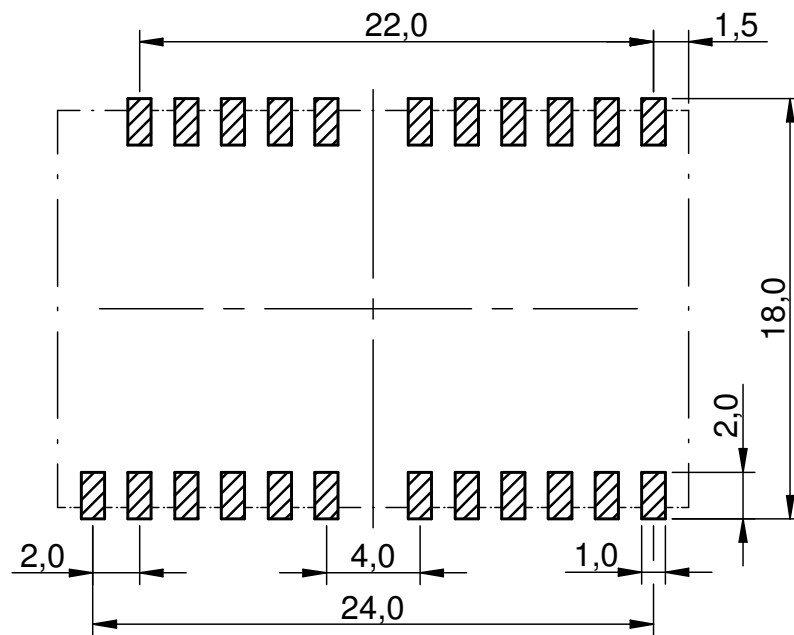

Figure 17: Footprint and dimensions [mm]

18.5. Antenna free area

To avoid influence and mismatching of the antenna the recommended free area around the antenna should be maintained. As rule of thumb a minimum distance of metal parts to the antenna of $\lambda/10$ should be kept (see figure 17). Even though metal parts would influence the characteristic of the antenna, but the direct influence and matching keep an acceptable level.

19. Marking

19.1. Lot number

The 15 digit lot number is printed in numerical digits as well as in form of a machine readable bar code. It is divided into 5 blocks as shown in the following picture and can be translated according to the following table.

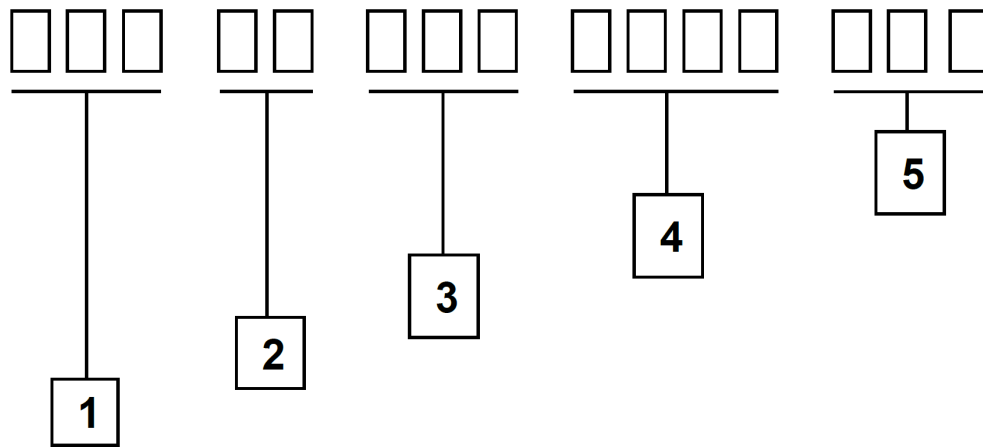

Figure 18: Lot number structure

Block	Information	Example(s)
1	eiSos internal, 3 digits	439
2	eiSos internal, 2 digits	01
3	Hardware version, 3 digits	V2.4 = 024, V12.2 = 122
4	Date code, 4 digits	1703 = week 03 in year 2017, 1816 = week 16 in year 2018
5	Firmware version, 3 digits	V3.2 = 302, V5.13 = 513

Table 22: Lot number details

As the user can perform a firmware update the printed lot number only shows the factory delivery state. The currently installed firmware can be requested from the module using the corresponding product specific command. The firmware version as well as the hardware version are restricted to show only major and minor version not the patch identifier.

19.2. General labeling information

The module labels may include the following fields:

- Manufacturer identification WE, Würth Elektronik or Würth Elektronik eiSos
- WE Order Code and/or article alias
- Serial number or MAC address
- Certification identifiers (CE, FCC ID, IC, ARIB,...)
- Bar code or 2D code containing the serial number or MAC address

If the module is using a Serial Number, this serial number includes the product ID (PID) and an 6 digit number. The 6 rightmost digits represent the 6 digit number, followed by the product ID (2 or 3 digits). Some labels indicate the product ID with a "." as marker in-between the 2 fields. The PID and the 6 digit number form together a unique serial number for any wireless connectivity product.

In case of small labels, the 3 byte manufacturer identifier (0x0018DA) of the MAC address is not printed on the labels. The 3 byte counter printed on the label can be used with this 0018DA to produce the full MAC address by appending the counter after the manufacturer identifier.



Figure 19: Label of the Thadeus

20. Information for Ex protection

In case the end product should be used in Ex protection areas the following information can be used:

- The module itself is unfused.
- The maximum output power of the module is 10dBm.
- The total amount of capacitance of all capacitors is 321.4nF.
- The total amount of inductance of all inductors is 1.103μH.

21. References

- [1] To calculate the baud rate registers UART_MCTL, UART_BR0 and UART_BR1, the "Baud Rate Calculator" tool is integrated in ACC. To configure a standard baud rate, ACC provides a drop-down field with automatic calculation and parameterisation of the baud rate registers.
- [2] "CC1101 Single-Chip Low-Cost Low-Power RF Transceiver", Texas Instruments

22. Regulatory compliance information

22.1. Important notice EU

The use of RF frequencies is limited by national regulations. The Thadeus has been designed to comply with the R&TTE directive 1999/5/EC and the RED directive 2014/53/EU of the European Union (EU).

The Thadeus can be operated without notification and free of charge in the area of the European Union. However, according to the R&TTE / RED directive, restrictions (e.g. in terms of duty cycle or maximum allowed RF power) may apply.

22.2. Conformity assessment of the final product

The Thadeus is a subassembly. It is designed to be embedded into other products (products incorporating the Thadeus are henceforward referred to as "final products").

It is the responsibility of the manufacturer of the final product to ensure that the final product is in compliance with the essential requirements of the underlying national radio regulations. The conformity assessment of the subassembly Thadeus carried out by Würth Elektronik eiSos does not replace the required conformity assessment of the final product.

22.3. Exemption clause

Relevant regulation requirements are subject to change. Würth Elektronik eiSos does not guarantee the accuracy of the before mentioned information. Directives, technical standards, procedural descriptions and the like may be interpreted differently by the national authorities. Equally, the national laws and restrictions may vary with the country. In case of doubt or uncertainty, we recommend that you consult with the authorities or official certification organizations of the relevant countries. Würth Elektronik eiSos is exempt from any responsibilities or liabilities related to regulatory compliance.

Notwithstanding the above, Würth Elektronik eiSos makes no representations and warranties of any kind related to their accuracy, correctness, completeness and/or usability for customer applications. No responsibility is assumed for inaccuracies or incompleteness.

22.4. EU Declaration of conformity

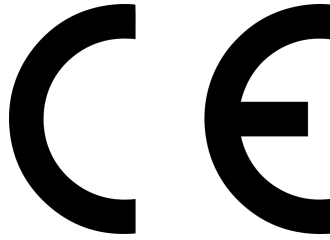

EU DECLARATION OF CONFORMITY

Radio equipment: 2605031141000

The manufacturer: Würth Elektronik eiSos GmbH & Co. KG
Max-Eyth-Straße 1
74638 Waldenburg

This declaration of conformity is issued under the sole responsibility of the manufacturer.

Object of the declaration: 2605031141000

The object of the declaration described above is in conformity with the relevant Union harmonisation legislation: Directive 2014/53/EU and 2011/65/EU.

Following harmonised norms or technical specifications have been applied:

EN 300 220-1 V3.1.1 (2017-02)
EN 300 220-2 V3.1.1 (2017-02)
EN 301 489-1 V2.2.0 (Draft)
EN 301 489-3 V2.1.1 (Final draft)
EN 62479 : 2010
EN 60950-1: 2006 + A11: 2009 + A1: 2010 + A12: 2011

i.A. G. Exler

Trier, 8th of November 2018
Place and date of issue

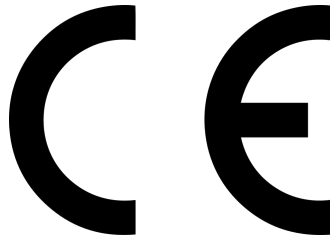
**EU DECLARATION OF CONFORMITY****Radio equipment:** 2605066241001**The manufacturer:** Würth Elektronik eiSos GmbH & Co. KG
Max-Eyth-Straße 1
74638 Waldenburg

This declaration of conformity is issued under the sole responsibility of the manufacturer.

Object of the declaration: 2605066241001

The object of the declaration described above is in conformity with the relevant Union harmonisation legislation: Directive 2014/53/EU and 2011/65/EU.

Following harmonised norms or technical specifications have been applied:

EN 300 220-1 V3.1.1 (2017-02)
EN 300 220-2 V3.1.1 (2017-02)
EN 301 489-1 V2.2.0 (Draft)
EN 301 489-3 V2.1.1 (Final draft)
EN 62479 : 2010
EN 60950-1: 2006 + A11: 2009 + A1: 2010 + A12: 2011

i.A. G. Exler

Trier, 8th of November 2018
Place and date of issue

23. Important notes

The following conditions apply to all goods within the wireless connectivity product range of Würth Elektronik eiSos GmbH & Co. KG:

23.1. General customer responsibility

Some goods within the product range of Würth Elektronik eiSos GmbH & Co. KG contain statements regarding general suitability for certain application areas. These statements about suitability are based on our knowledge and experience of typical requirements concerning the areas, serve as general guidance and cannot be estimated as binding statements about the suitability for a customer application. The responsibility for the applicability and use in a particular customer design is always solely within the authority of the customer. Due to this fact, it is up to the customer to evaluate, where appropriate to investigate and to decide whether the device with the specific product characteristics described in the product specification is valid and suitable for the respective customer application or not. Accordingly, the customer is cautioned to verify that the documentation is current before placing orders.

23.2. Customer responsibility related to specific, in particular safety-relevant applications

It has to be clearly pointed out that the possibility of a malfunction of electronic components or failure before the end of the usual lifetime cannot be completely eliminated in the current state of the art, even if the products are operated within the range of the specifications. The same statement is valid for all software sourcecode and firmware parts contained in or used with or for products in the wireless connectivity and sensor product range of Würth Elektronik eiSos GmbH & Co. KG. In certain customer applications requiring a high level of safety and especially in customer applications in which the malfunction or failure of an electronic component could endanger human life or health, it must be ensured by most advanced technological aid of suitable design of the customer application that no injury or damage is caused to third parties in the event of malfunction or failure of an electronic component.

23.3. Best care and attention

Any product-specific data sheets, manuals, application notes, PCN's, warnings and cautions must be strictly observed in the most recent versions and matching to the products firmware revisions. This documents can be downloaded from the product specific sections on the wireless connectivity homepage.

23.4. Customer support for product specifications

Some products within the product range may contain substances, which are subject to restrictions in certain jurisdictions in order to serve specific technical requirements. Necessary information is available on request. In this case, the field sales engineer or the internal sales person in charge should be contacted who will be happy to support in this matter.

23.5. Product improvements

Due to constant product improvement, product specifications may change from time to time. As a standard reporting procedure of the Product Change Notification (PCN) according to the JEDEC-Standard, we inform about major changes. In case of further queries regarding the PCN, the field sales engineer, the internal sales person or the technical support team in charge should be contacted. The basic responsibility of the customer as per section 23.1 and 23.2 remains unaffected. All wireless connectivity module driver software "wireless connectivity SDK" and its source codes as well as all PC software tools are not subject to the Product Change Notification information process.

23.6. Product life cycle

Due to technical progress and economical evaluation we also reserve the right to discontinue production and delivery of products. As a standard reporting procedure of the Product Termination Notification (PTN) according to the JEDEC-Standard we will inform at an early stage about inevitable product discontinuance. According to this, we cannot ensure that all products within our product range will always be available. Therefore, it needs to be verified with the field sales engineer or the internal sales person in charge about the current product availability expectancy before or when the product for application design-in disposal is considered. The approach named above does not apply in the case of individual agreements deviating from the foregoing for customer-specific products.

23.7. Property rights

All the rights for contractual products produced by Würth Elektronik eiSos GmbH & Co. KG on the basis of ideas, development contracts as well as models or templates that are subject to copyright, patent or commercial protection supplied to the customer will remain with Würth Elektronik eiSos GmbH & Co. KG. Würth Elektronik eiSos GmbH & Co. KG does not warrant or represent that any license, either expressed or implied, is granted under any patent right, copyright, mask work right, or other intellectual property right relating to any combination, application, or process in which Würth Elektronik eiSos GmbH & Co. KG components or services are used.

23.8. General terms and conditions

Unless otherwise agreed in individual contracts, all orders are subject to the current version of the "General Terms and Conditions of Würth Elektronik eiSos Group", last version available at www.we-online.com.

24. Legal notice

24.1. Exclusion of liability

Würth Elektronik eiSos GmbH & Co. KG considers the information in this document to be correct at the time of publication. However, Würth Elektronik eiSos GmbH & Co. KG reserves the right to modify the information such as technical specifications or functions of its products or discontinue the production of these products or the support of one of these products without any written announcement or notification to customers. The customer must make sure that the information used corresponds to the latest published information. Würth Elektronik eiSos GmbH & Co. KG does not assume any liability for the use of its products. Würth Elektronik eiSos GmbH & Co. KG does not grant licenses for its patent rights or for any other of its intellectual property rights or third-party rights.

Notwithstanding anything above, Würth Elektronik eiSos GmbH & Co. KG makes no representations and/or warranties of any kind for the provided information related to their accuracy, correctness, completeness, usage of the products and/or usability for customer applications. Information published by Würth Elektronik eiSos GmbH & Co. KG regarding third-party products or services does not constitute a license to use such products or services or a warranty or endorsement thereof.

24.2. Suitability in customer applications

The customer bears the responsibility for compliance of systems or units, in which Würth Elektronik eiSos GmbH & Co. KG products are integrated, with applicable legal regulations. Customer acknowledges and agrees that it is solely responsible for compliance with all legal, regulatory and safety-related requirements concerning its products, and any use of Würth Elektronik eiSos GmbH & Co. KG components in its applications, notwithstanding any applications-related information or support that may be provided by Würth Elektronik eiSos GmbH & Co. KG. Customer represents and agrees that it has all the necessary expertise to create and implement safeguards which anticipate dangerous consequences of failures, monitor failures and their consequences lessen the likelihood of failures that might cause harm and take appropriate remedial actions. The customer will fully indemnify Würth Elektronik eiSos GmbH & Co. KG and its representatives against any damages arising out of the use of any Würth Elektronik eiSos GmbH & Co. KG components in safety-critical applications.

24.3. Trademarks

AMBER wireless is a registered trademark of Würth Elektronik eiSos GmbH & Co. KG. All other trademarks, registered trademarks, and product names are the exclusive property of the respective owners.

24.4. Usage restriction

Würth Elektronik eiSos GmbH & Co. KG products have been designed and developed for usage in general electronic equipment only. This product is not authorized for use in equipment where a higher safety standard and reliability standard is especially required or where

a failure of the product is reasonably expected to cause severe personal injury or death, unless the parties have executed an agreement specifically governing such use. Moreover, Würth Elektronik eiSos GmbH & Co. KG products are neither designed nor intended for use in areas such as military, aerospace, aviation, nuclear control, submarine, transportation (automotive control, train control, ship control), transportation signal, disaster prevention, medical, public information network etc. Würth Elektronik eiSos GmbH & Co. KG must be informed about the intent of such usage before the design-in stage. In addition, sufficient reliability evaluation checks for safety must be performed on every electronic component, which is used in electrical circuits that require high safety and reliability function or performance. By using Würth Elektronik eiSos GmbH & Co. KG products, the customer agrees to these terms and conditions.

25. License terms

This License Terms will take effect upon the purchase and usage of the Würth Elektronik eiSos GmbH & Co. KG wireless connectivity products. You hereby agree that this license terms is applicable to the product and the incorporated software, firmware and source codes (collectively, "Software") made available by Würth Elektronik eiSos in any form, including but not limited to binary, executable or source code form.

The software included in any Würth Elektronik eiSos wireless connectivity product is purchased to you on the condition that you accept the terms and conditions of this license terms. You agree to comply with all provisions under this license terms.

25.1. Limited license

Würth Elektronik eiSos hereby grants you a limited, non-exclusive, non-transferable and royalty-free license to use the software and under the conditions that will be set forth in this license terms. You are free to use the provided Software only in connection with one of the products from Würth Elektronik eiSos to the extent described in this license terms. You are entitled to change or alter the source code for the sole purpose of creating an application embedding the Würth Elektronik eiSos wireless connectivity product. The transfer of the source code to third parties is allowed to the sole extent that the source code is used by such third parties in connection with our product or another hardware provided by Würth Elektronik eiSos under strict adherence of this license terms. Würth Elektronik eiSos will not assume any liability for the usage of the incorporated software and the source code. You are not entitled to transfer the source code in any form to third parties without prior written consent of Würth Elektronik eiSos.

You are not allowed to reproduce, translate, reverse engineer, decompile, disassemble or create derivative works of the incorporated Software and the source code in whole or in part. No more extensive rights to use and exploit the products are granted to you.

25.2. Usage and obligations

The responsibility for the applicability and use of the Würth Elektronik eiSos wireless connectivity product with the incorporated Firmware in a particular customer design is always solely within the authority of the customer. Due to this fact, it is up to you to evaluate and investigate, where appropriate, and to decide whether the device with the specific product characteristics described in the product specification is valid and suitable for your respective application or not.

You are responsible for using the Würth Elektronik eiSos wireless connectivity product with the incorporated Firmware in compliance with all applicable product liability and product safety laws. You acknowledge to minimize the risk of loss and harm to individuals and bear the risk for failure leading to personal injury or death due to your usage of the product.

Würth Elektronik eiSos' products with the incorporated Firmware are not authorized for use in safety-critical applications, or where a failure of the product is reasonably expected to cause severe personal injury or death. Moreover, Würth Elektronik eiSos' products with the incorporated Firmware are neither designed nor intended for use in areas such as military, aerospace, aviation, nuclear control, submarine, transportation (automotive control, train control, ship control), transportation signal, disaster prevention, medical, public information network etc. You shall inform Würth Elektronik eiSos about the intent of such usage before

design-in stage. In certain customer applications requiring a very high level of safety and in which the malfunction or failure of an electronic component could endanger human life or health, you must ensure to have all necessary expertise in the safety and regulatory ramifications of your applications. You acknowledge and agree that you are solely responsible for all legal, regulatory and safety-related requirements concerning your products and any use of Würth Elektronik eiSos' products with the incorporated Firmware in such safety-critical applications, notwithstanding any applications-related information or support that may be provided by Würth Elektronik eiSos. YOU SHALL INDEMNIFY WÜRTH ELEKTRONIK EISOS AGAINST ANY DAMAGES ARISING OUT OF THE USE OF WÜRTH ELEKTRONIK EISOS' PRODUCTS WITH THE INCORPORATED FIRMWARE IN SUCH SAFETY-CRITICAL APPLICATIONS.

25.3. Ownership

The incorporated Firmware created by Würth Elektronik eiSos is and will remain the exclusive property of Würth Elektronik eiSos.

25.4. Firmware update(s)

You have the opportunity to request the current and actual Firmware for a bought wireless connectivity Product within the time of warranty. However, Würth Elektronik eiSos has no obligation to update a modules firmware in their production facilities, but can offer this as a service on request. The upload of firmware updates falls within your responsibility, e.g. via ACC or another software for firmware updates. Firmware updates will not be communicated automatically. It is within your responsibility to check the current version of a firmware in the latest version of the product manual on our website. The revision table in the product manual provides all necessary information about firmware updates. There is no right to be provided with binary files, so called "Firmware images", those could be flashed through JTAG, SWD, Spi-Bi-Wire, SPI or similar interfaces.

25.5. Disclaimer of warranty

THE FIRMWARE IS PROVIDED "AS IS". YOU ACKNOWLEDGE THAT WÜRTH ELEKTRONIK EISOS MAKES NO REPRESENTATIONS AND WARRANTIES OF ANY KIND RELATED TO, BUT NOT LIMITED TO THE NON-INFRINGEMENT OF THIRD PARTIES' INTELLECTUAL PROPERTY RIGHTS OR THE MERCHANTABILITY OR FITNESS FOR YOUR INTENDED PURPOSE OR USAGE. WÜRTH ELEKTRONIK EISOS DOES NOT WARRANT OR REPRESENT THAT ANY LICENSE, EITHER EXPRESS OR IMPLIED, IS GRANTED UNDER ANY PATENT RIGHT, COPYRIGHT, MASK WORK RIGHT, OR OTHER INTELLECTUAL PROPERTY RIGHT RELATING TO ANY COMBINATION, MACHINE, OR PROCESS IN WHICH THE WÜRTH ELEKTRONIK EISOS' PRODUCT WITH THE INCORPORATED FIRMWARE IS USED. INFORMATION PUBLISHED BY WÜRTH ELEKTRONIK EISOS REGARDING THIRD-PARTY PRODUCTS OR SERVICES DOES NOT CONSTITUTE A LICENSE FROM WÜRTH ELEKTRONIK EISOS TO USE SUCH PRODUCTS OR SERVICES OR A WARRANTY OR ENDORSEMENT THEREOF.

25.6. Limitation of liability

Any liability not expressly provided by Würth Elektronik eiSos shall be disclaimed. You agree to hold us harmless from any third-party claims related to your usage of the Würth Elektronik eiSos' products with the incorporated Firmware, software and source code. Würth Elektronik eiSos disclaims any liability for any alteration, development created by you or your customers as well as for any combination with other products.

25.7. Applicable law and jurisdiction

Applicable law to this license terms shall be the laws of the Federal Republic of Germany. Any dispute, claim or controversy arising out of or relating to this license terms shall be resolved and finally settled by the court competent for the location of Würth Elektronik eiSos' registered office.

25.8. Severability clause

If a provision of this license terms is or becomes invalid, unenforceable or null and void, this shall not affect the remaining provisions of the terms. The parties shall replace any such provisions with new valid provisions that most closely approximate the purpose of the terms.

25.9. Miscellaneous

Würth Elektronik eiSos reserves the right at any time to change this terms at its own discretion. It is your responsibility to check at Würth Elektronik eiSos homepage for any updates. Your continued usage of the products will be deemed as the acceptance of the change. We recommend you to be updated about the status of new firmware and software, which is available on our website or in our data sheet and manual, and to implement new software in your device where appropriate. By ordering a wireless connectivity product, you accept this license terms in all terms.

List of Figures

1.	Block diagram	8
2.	Pinout	12
3.	Relation between the RX level and the RSSI value read out for Thadeus	27
4.	Command mode power up	44
5.	Layout	56
6.	Placement of the module with integrated antenna	57
7.	Dimensioning the antenna feed line as micro strip	58
8.	169 MHz dipole-antenna	60
9.	434 MHz dipole-antenna	61
10.	868 MHz dipole-antenna	62
11.	868 MHz magnet foot antenna with 1.5 m antenna cable	63
12.	2.4 GHz dipole-antenna	64
13.	Assembly diagram	68
14.	Top and Bottom Layer	69
15.	Reflow soldering profile	71
16.	Module dimensions [mm]	75
17.	Footprint and dimensions [mm]	76
18.	Lot number structure	77
19.	Label of the Thadeus	78

List of Tables

1.	Ordering information	8
2.	Recommended operating conditions	9
3.	Absolute maximum ratings	9
4.	Power consumption	10
5.	Radio characteristics	11
6.	Pin characteristics	11
7.	Pinout	14
8.	Communication in transparent mode	18
9.	Telegram format in the command mode	22
10.	Overview of non-volatile configuration parameters - Part 1	34
11.	Overview of non-volatile configuration parameters - Part 2	35
12.	Setting the UART control configuration	36
13.	Recommended ACK timeouts	40
14.	CC1101 PA Mapping, 434 MHz	41
15.	Configuration flags	43
16.	Recommended channel selection for "H" band, the default channel is shown in bold	48
17.	Power consumption control	49
18.	Classification reflow soldering profile, Note: refer to IPC/JEDEC J-STD-020E	70
19.	Package classification reflow temperature, PB-free assembly, Note: refer to IPC/JEDEC J-STD-020E	71
20.	Dimensions	74
21.	Weight	74
22.	Lot number details	77

23. CRC8 Test Vectors 93

A. Additional CRC8 Information

This Annex gives an example CRC8 implementation and test vectors. This CRC8 is

A.1. Example CRC8 Implementation

```
#include <stdint.h>

uint8_t Get_CRC8(uint8_t * bufP, uint16_t len)
{
    uint8_t crc = 0x00;
    for (uint16_t i = 0; i < len; i++)
    {
        crc ^= bufP[i];
    }
    return crc;
}
```

Code 1: Example CRC8 Implementation

A.1.1. CRC8 Test Vectors

Input data	Data length	Resulting CRC8
Null	0	0x00
0x02 0x01 0x00 0x00	4	0x03
0x02 0x87 0x01 0x00 0x16	5	0x92
0x02 0x04 0x04 0x00 0x41 0x42 0x43 0x44	8	0x06
0x02 0x88 0x07 0x00 0x00 0x55 0x00 0x00 0xDA 0x18 0x00	11	0x1A

Table 23: CRC8 Test Vectors

B. Example codes for host integration

The following code is an example implementation of a function to transmit data using a 1 Byte length field in the command frame. For demonstration reasons the Tarvos-III has been taken. The full function codes of all radio modules are available in the Wireless Connectivity SDK (www.we-online.de/wco-SDK).

```
#define CMD_PAYLOAD_MAX 224
typedef struct {
    uint8_t Stx;
    uint8_t Cmd;
    uint8_t Length;
    uint8_t Data[CMD_PAYLOAD_MAX+1]; /* +1 for CRC8 */
} CMD_Frame_t;
#define CMD_OFFSET_TO_DATAFIELD 3
#define CMD_OVERHEAD (CMD_OFFSET_TO_DATAFIELD+1)

bool TarvosIII_Transmit(uint8_t *PayloadP, uint8_t length)
{
    /* fill request message with STX, command byte and length field */
    CMD_Frame_t CMD_Frame;
    CMD_Frame.Stx = CMD_STX; /* 0x02 */
    CMD_Frame.Cmd = TarvosIII_CMD_DATA_REQ; /* 0x00 */
    CMD_Frame.Length = length;

    /* fill request message with user payload */
    memcpy(CMD_Frame.Data, PayloadP, length);

    /* fill request message with CRC8 */
    CMD_Frame.Data[CMD_Frame.Length] = Get_CRC8(&CMD_Frame, CMD_Frame.Length +
        CMD_OFFSET_TO_DATAFIELD);

    /* transmit full message via UART to radio module */
    UART_SendBytes(&CMD_Frame, (CMD_Frame.Length + CMD_OVERHEAD));

    /* wait for response message from radio module */
    return UART_Wait_for_Response(CMD_WAIT_TIME, TarvosIII_CMD_DATA_CNF, CMD_Status_Success,
        true);
}
```

Code 2: Example function implementation for radio modules with 1 byte length field



more than you expect



**Internet
of Things**



**Monitoring
& Control**



**Automated Meter
Reading**

Contact:

Würth Elektronik eiSos GmbH & Co. KG
Division Wireless Connectivity & Sensors

Max-Eyth-Straße 1
74638 Waldenburg
Germany

Tel.: +49 651 99355-0
Fax.: +49 651 99355-69
www.we-online.com/wireless-connectivity

