

LOC	DIST	REVISIONS					
E	B	P	LTR	DESCRIPTION	DATE	DWN	APVD
			BA	NEW RELEASE	19-AUG-09	MRS	St.P

FOR FURTHER INFORMATION SEE DATA SHEET FOR
CRG SERIES-THICK FILM CHIP RESISTORS

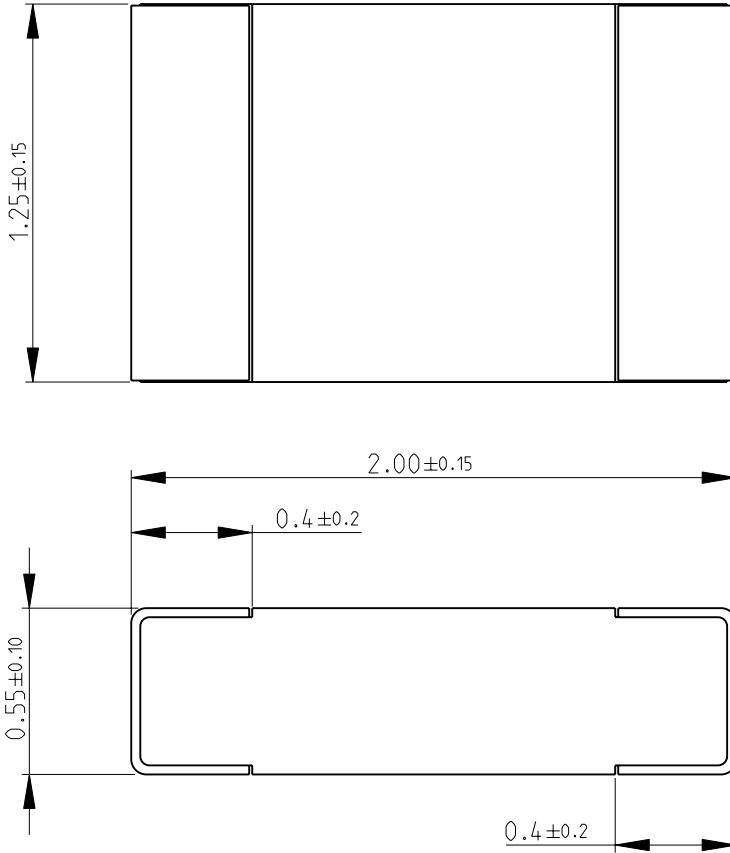

RoHS Compliant

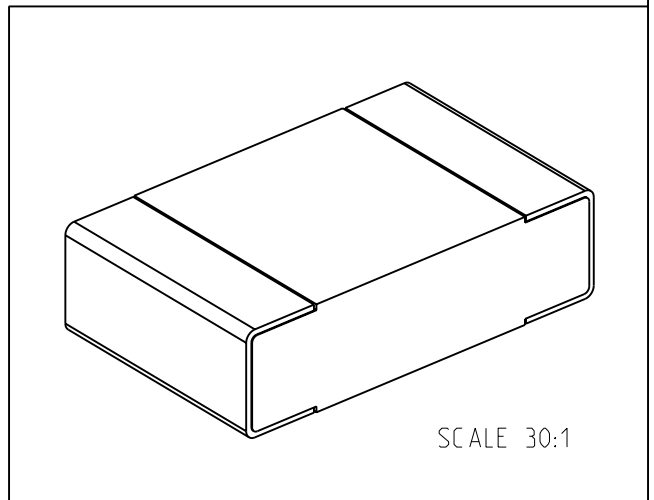

SCALE 30:1

2009

RELEASED FOR PUBLICATION

THIS DRAWING IS UNPUBLISHED.

© COPYRIGHT 2009 BY TYCO ELECTRONICS CORPORATION. ALL RIGHTS RESERVED.

DIMENSIONS: mm	DWN MAHARUDRA	19-AUG-09	MATERIAL	-	FINISH	-
	CHK ALLAN.P	19-AUG-09	Tyco Electronics Corporation Dorcan, Swindon, SN3 5HH			
TOLERANCES UNLESS OTHERWISE SPECIFIED:	APVD STEPHEN.P	19-AUG-09				
0 PLC ±0.5	PRODUCT SPEC	-	NAME THICK FILM CHIP RESISTORS SERIES CRG 0805			
1 PLC ±0.2	APPLICATION SPEC	-	SIZE	CAGE CODE	DRAWING NO	RESTRICTED TO
2 PLC ±0.1			A 4	00779	© = 1623327	-
3 PLC ±-	WEIGHT	-	CUSTOMER DRAWING			
4 PLC ±-			SCALE	40:1	SHEET	1 OF 1
ANGLES ±5°			REV BA			