

The S-8353/8354 Series is a CMOS step-up switching regulator which mainly consists of a reference voltage source, an oscillation circuit, a power MOS FET, an error amplifier, a phase compensation circuit, a PWM control circuit (S-8353 Series) and a PWM / PFM switching control circuit (S-8354 Series).

The S-8353/8354 Series can configure the step-up switching regulator with an external coil, capacitor, and diode. In addition to the above features, the small package and low current consumption make the S-8353/8354 Series ideal for portable equipment applications requiring high efficiency.

The S-8353 Series realizes low ripple, high efficiency, and excellent transient characteristics due to its PWM control circuit whose duty ratio can be varied linearly from 0% to 83% (from 0% to 78% for 250 kHz models), an excellently designed error amplifier, and phase compensation circuits.

The S-8354 Series features a PWM / PFM switching controller that can switch the operation to a PFM controller with a duty ratio is 15% under a light load to prevent a decline in the efficiency due to the IC operating current.

■ Features

- Low voltage operation: Startup at 0.9 V min. ($I_{OUT} = 1$ mA) guaranteed
- Low current consumption : During operation 18.7 μ A (3.3 V, 50 kHz, typ.)
During shutdown: 0.5 μ A (max.)
- Duty ratio : Built-in PWM / PFM switching control circuit (S-8354 Series)
15 % to 83 % (30 kHz and 50 kHz models)
15 % to 78 % (250 kHz models)
- External parts : Coil, capacitor, and diode
- Output voltage : Selectable in 0.1 V steps between 1.5 V and 6.5 V (for V_{DD} / V_{OUT} separate types)
Selectable in 0.1 V steps between 2.0 V and 6.5 V (for other than V_{DD} / V_{OUT} separate types)
- Output voltage accuracy : $\pm 2.4\%$
- Oscillation frequency : 30 kHz, 50 kHz, and 250 kHz selectable
- Soft start function : 6 ms (50 kHz, typ.)
- Lead-free, Sn 100%, halogen-free*1

*1. Refer to "■ Product Name Structure" for details.

■ Applications

- Power supplies for portable equipment such as digital cameras, electronic notebooks, and PDAs
- Power supplies for audio equipment such as portable CD / MD players
- Constant voltage power supplies for cameras, VCRs, and communication devices
- Power supplies for microcomputers

■ Packages

- SOT-23-3
- SOT-23-5
- SOT-89-3

■ Block Diagrams

(1) A, C and H Types (Without Shutdown Function)

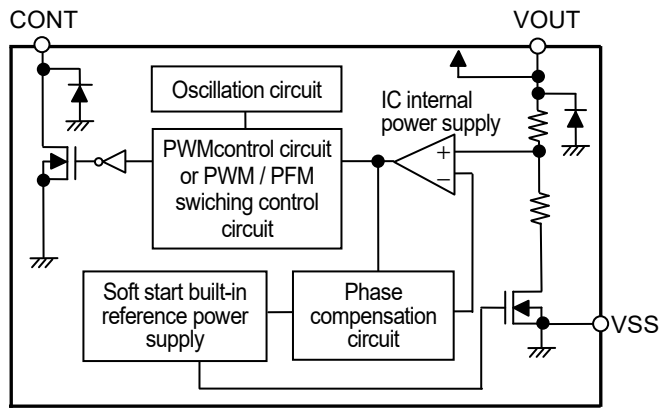

Figure 1

(2) A and H Types (With Shutdown Function)

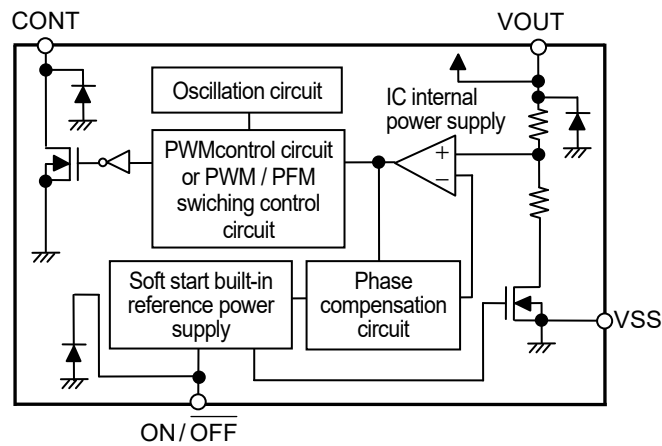

Figure 2

(3) D and J Types (V_{DD} / V_{OUT} Separate Type)

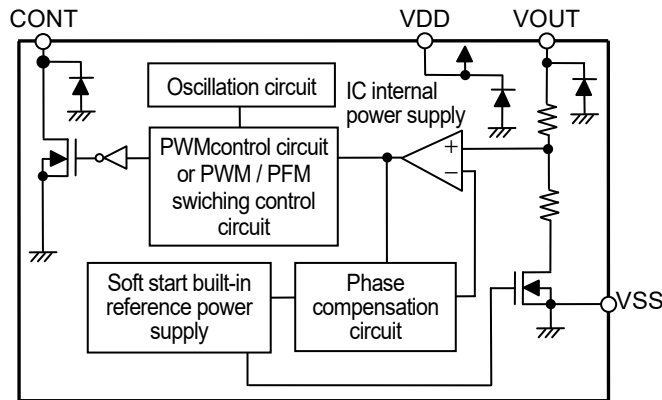

Figure 3

■ Product Name Structure

The control system, product types, output voltage, and packages for the S-8353/8354 Series can be selected at the user's request. Please refer to the "3. Product Name" for the definition of the product name, "4. Package" regarding the package drawings and "5. Product Name List" for the full product names.

1. Function List

(1) PWM Control Products

Table 1

Product Name	Switching Frequency [kHz]	Shutdown Function	V _{DD} / V _{OUT} Separate Type	Package	Application
S-8353AxxMC	50	Yes	–	SOT-23-5	Applications requiring shutdown function
S-8353AxxMA	50	–	–	SOT-23-3	Applications not requiring shutdown function
S-8353AxxUA	50	–	–	SOT-89-3	Applications not requiring shutdown function
S-8353CxxMA	30	–	–	SOT-23-3	For pager
S-8353CxxUA	30	–	–	SOT-89-3	For pager
S-8353DxxMC	50	–	Yes	SOT-23-5	Applications requiring variable output voltage with an external resistor
S-8353HxxMC	250	Yes	–	SOT-23-5	Applications requiring a shutdown function and a thin coil
S-8353HxxMA	250	–	–	SOT-23-3	Applications not requiring a shutdown function and requiring a thin coil
S-8353HxxUA	250	–	–	SOT-89-3	Applications not requiring a shutdown function and requiring a thin coil
S-8353JxxMC	250	–	Yes	SOT-23-5	Applications requiring variable output voltage with an external resistor and a thin coil

(2) PWM / PFM Switching Control Products

Table 2

Product Name	Switching Frequency [kHz]	Shutdown Function	V _{DD} / V _{OUT} Separate Type	Package	Application
S-8354AxxMC	50	Yes	–	SOT-23-5	Applications requiring shutdown function
S-8354AxxMA	50	–	–	SOT-23-3	Applications not requiring shutdown function
S-8354AxxUA	50	–	–	SOT-89-3	Applications not requiring shutdown function
S-8354CxxMA	30	–	–	SOT-23-3	For pager
S-8354DxxMC	50	–	Yes	SOT-23-5	Applications requiring variable output voltage with an external resistor
S-8354HxxMC	250	Yes	–	SOT-23-5	Applications requiring a shutdown function and a thin coil
S-8354HxxMA	250	–	–	SOT-23-3	Applications not requiring a shutdown function and requiring a thin coil
S-8354HxxUA	250	–	–	SOT-89-3	Applications not requiring a shutdown function and requiring a thin coil
S-8354JxxMC	250	–	Yes	SOT-23-5	Applications requiring variable output voltage with an external resistor and a thin coil

2. Package and Function List by Product Type

Table 3

Series Name	Type	Package Name (Abbreviation)	Shutdown Function Yes / No	V _{DD} / V _{OUT} Separate Type Yes / No
S-8353 Series, S-8354 Series	A (Normal product or with shutdown function) A = 50 kHz	MC	Yes	No
		MA / UA	No	
	C (Normal product) C = 30 kHz	MA	No	No
	D (V _{DD} / V _{OUT} separate type) D = 50 kHz	MC	No	Yes
	H (Normal product or with shutdown function) H = 250 kHz	MC	Yes	No
		MA / UA	No	
	J (V _{DD} / V _{OUT} separate type) J = 250 kHz	MC	No	Yes

3. Product Name

(1) SOT-23-3

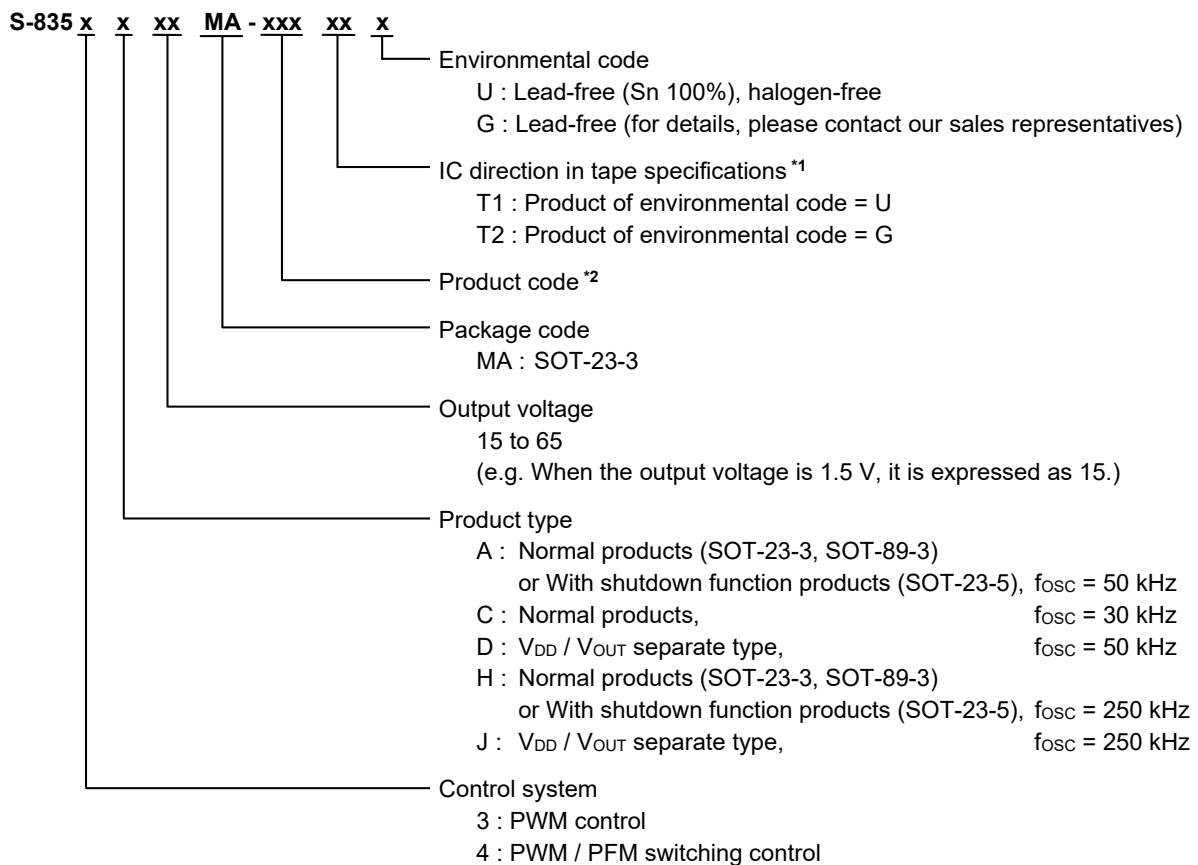

*1. Refer to the tape specifications.

*2. Refer to the **Table 4** to **Table 8** in the "**5. Product Name List**".

(2) SOT-23-5, SOT-89-3

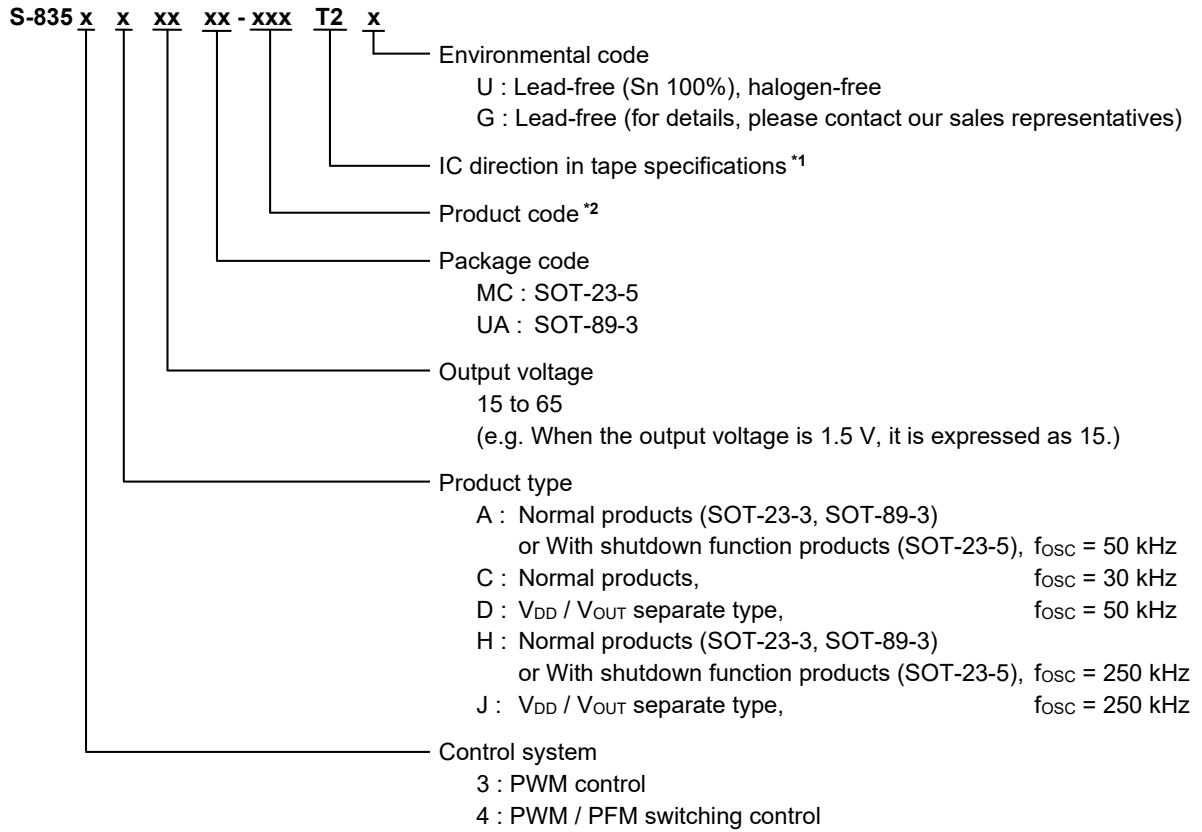

*1. Refer to the tape specifications.

*2. Refer to the **Table 4** to **Table 8** in the “**5. Product Name List**”.

4. Package

Package Name		Drawing Code		
		Package	Tape	Reel
SOT-23-3	Environmental code = G	MP003-A-P-SD	MP003-A-C-SD	MP003-A-R-SD
	Environmental code = U	MP003-C-P-SD	MP003-C-C-SD	MP003-Z-R-SD
SOT-23-5		MP005-A-P-SD	MP005-A-C-SD	MP005-A-R-SD
SOT-89-3		UP003-A-P-SD	UP003-A-C-SD	UP003-A-R-SD

5. Product Name List

(1) S-8353 Series

Table 4

Output voltage	S-8353AxxMC Series	S-8353AxxMA Series	S-8353AxxUA Series	S-8353CxxMA Series
2.0 V	S-8353A20MC-IQFT2x	–	–	–
2.5 V	S-8353A25MC-IQKT2x	–	–	–
2.7 V	S-8353A27MC-IQMT2x	–	–	–
2.8 V	S-8353A28MC-IQNT2x	–	–	–
3.0 V	S-8353A30MC-IQPT2x	S-8353A30MA-IQPT□□	S-8353A30UA-IQPT2x	S-8353C30MA-ISPT□□
3.3 V	S-8353A33MC-IQST2x	S-8353A33MA-IQST□□	S-8353A33UA-IQST2x	–
3.5 V	S-8353A35MC-IQUT2x	–	–	–
3.6 V	–	–	S-8353A36UA-IQVT2x	–
3.8 V	S-8353A38MC-IQXT2x	–	S-8353A38UA-IQXT2x	–
4.0 V	–	–	S-8353A40UA-IQZT2x	–
4.5 V	S-8353A45MC-IRET2x	–	–	–
4.6 V	–	–	–	S-8353C46MA-ITFT□□
5.0 V	S-8353A50MC-IRJT2x	S-8353A50MA-IRJT□□	S-8353A50UA-IRJT2x	–
5.5 V	S-8353A55MC-IROT2x	–	S-8353A55UA-IROT2x	–

Table 5

Output voltage	S-8353CxxUA Series	S-8353DxxMC Series	S-8353HxxMC Series	S-8353HxxMA Series
2.0 V	–	S-8353D20MC-IUFT2x	S-8353H20MC-IWFT2x	–
2.6 V	–	–	S-8353H26MC-IWLT2x	–
2.8 V	–	–	S-8353H28MC-IWNT2x	–
3.0 V	S-8353C30UA-ISPT2x	S-8353D30MC-IUPT2x	S-8353H30MC-IWPT2x	S-8353H30MA-IWPT□□
3.1 V	–	–	S-8353H31MC-IWQT2x	–
3.2 V	–	–	S-8353H32MC-IWRT2x	–
3.3 V	–	–	S-8353H33MC-IWST2x	S-8353H33MA-IWST□□
3.5 V	–	–	S-8353H35MC-IWUT2x	–
3.7 V	–	–	S-8353H37MC-IWWT2x	–
3.8 V	–	–	S-8353H38MC-IWXT2x	–
4.0 V	–	–	S-8353H40MC-IWZT2x	–
4.5 V	–	–	S-8353H45MC-IXET2x	–
5.0 V	–	S-8353D50MC-IVJT2x	S-8353H50MC-IXJT2x	–
6.0 V	–	–	S-8353H60MC-IXTT2x	–
6.5 V	–	–	S-8353H65MC-IXYT2x	–

Remark 1. Please contact our sales representatives for products other than the above.

2. x: G or U
3. □□: 2G or 1U
4. Please select products of environmental code = U for Sn 100%, halogen-free products.

Table 6

Output voltage	S-8353HxxUA Series	S-8353JxxMC Series
1.8 V	–	S-8353J18MC-IYDT2x
2.0 V	–	S-8353J20MC-IYFT2x
2.1 V	–	S-8353J21MC-IYGT2x
2.5 V	–	S-8353J25MC-IYKT2x
3.0 V	–	S-8353J30MC-IYPT2x
3.3 V	S-8353H33UA-IWST2x	S-8353J33MC-IYST2x
3.6 V	S-8353H36UA-IWVT2x	–
5.0 V	S-8353H50UA-IXJT2x	S-8353J50MC-IZJT2x

(2) S-8354 Series

Table 7

Output voltage	S-8354AxxMC Series	S-8354AxxMA Series	S-8354AxxUA Series	S-8354CxxMA Series
2.0 V	–	S-8354A20MA-JQFT□□	–	–
2.7 V	S-8354A27MC-JQMT2x	S-8354A27MA-JQMT□□	–	–
2.8 V	–	S-8354A28MA-JQNT□□	S-8354A28UA-JQNT2x	–
3.0 V	S-8354A30MC-JQPT2x	S-8354A30MA-JQPT□□	S-8354A30UA-JQPT2x	S-8354C30MA-JSPT□□
3.3 V	S-8354A33MC-JQST2x	S-8354A33MA-JQST□□	S-8354A33UA-JQST2x	–
3.5 V	–	–	S-8354A35UA-JQUT2x	–
3.8 V	S-8354A38MC-JQXT2x	–	–	–
4.0 V	S-8354A40MC-JQZT2x	–	S-8354A40UA-JQZT2x	–
5.0 V	S-8354A50MC-JRJT2x	S-8354A50MA-JRJT□□	S-8354A50UA-JRJT2x	–

Table 8

Output voltage	S-8354DxxMC Series	S-8354HxxMC Series	S-8354HxxUA Series	S-8354JxxMC Series
1.5 V	–	–	–	S-8354J15MC-JYAT2x
2.0 V	S-8354D20MC-JUFT2x	–	–	S-8354J20MC-JYFT2x
2.5 V	–	S-8354H25MC-JWKT2x	–	–
2.7V	–	S-8354H27MC-JWMT2x	S-8354H27UA-JWMT2x	–
3.0 V	S-8354D30MC-JUPT2x	S-8354H30MC-JWPT2x	–	S-8354J30MC-JYPT2x
3.1 V	–	S-8354H31MC-JWQT2x	–	–
3.3 V	S-8354D33MC-JUST2x	S-8354H33MC-JWST2x	–	S-8354J33MC-JYST2x
3.5 V	–	S-8354H35MC-JWUT2x	–	–
4.0 V	–	S-8354H40MC-JWZT2x	–	–
4.2 V	–	S-8354H42MC-JXBT2x	–	–
4.5 V	–	S-8354H45MC-JXET2x	–	–
4.7 V	–	S-8354H47MC-JXGT2x	–	–
5.0 V	–	S-8354H50MC-JXJT2x	–	S-8354J50MC-JZJT2x

- Remark 1.** Please contact our sales representatives for products other than the above.
2. x: G or U
3. □□: 2G or 1U
4. Please select products of environmental code = U for Sn 100%, halogen-free products.

■ Pin Configurations

SOT-23-3
Top view



Figure 4

SOT-23-5
Top view

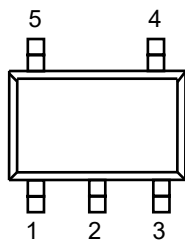

Figure 5

SOT-89-3
Top view

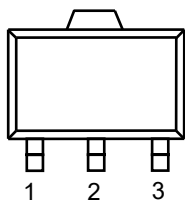

Figure 6

Table 9 A, C and H Types
(Without shutdown function, V_{DD} / V_{OUT} non-separate type)

Pin No.	Symbol	Description
1	VOUT	Output voltage pin and IC power supply pin
2	VSS	GND pin
3	CONT	External inductor connection pin

Table 10 A and H Types
(With shutdown function, V_{DD} / V_{OUT} non-separate type)

Pin No.	Symbol	Description
1	ON/ $\overline{\text{OFF}}$	Shutdown pin “H”: Normal operation (Step-up operating) “L”: Step-up stopped (Entire circuit stopped)
2	VOUT	Output voltage pin and IC power supply pin
3	NC*1	No connection
4	VSS	GND pin
5	CONT	External inductor connection pin

*1. The NC pin indicates electrically open.

Table 11 D and J Types
(Without shutdown function, V_{DD} / V_{OUT} separate type)

Pin No.	Symbol	Description
1	VOUT	Output voltage pin
2	VDD	IC power supply pin
3	NC*1	No connection
4	VSS	GND pin
5	CONT	External inductor connection pin

*1. The NC pin indicates electrically open.

Table 12 A and H Types
(Without shutdown function, V_{DD} / V_{OUT} non-separate type)

Pin No.	Symbol	Description
1	VSS	GND pin
2	VOUT	Output voltage pin and IC power supply pin
3	CONT	External inductor connection pin

■ Absolute Maximum Ratings

Table 13

(Ta = 25°C unless otherwise specified)

Item	Symbol	Absolute maximum rating	Unit		
VOUT pin voltage	V _{OUT}	V _{SS} - 0.3 to V _{SS} + 12	V		
ON/OFF pin voltage*1	V _{ON/OFF}	V _{SS} - 0.3 to V _{SS} + 12	V		
VDD pin voltage*2	V _{DD}	V _{SS} - 0.3 to V _{SS} + 12	V		
CONT pin voltage	V _{CONT}	V _{SS} - 0.3 to V _{SS} + 12	V		
CONT pin current	I _{CONT}	300	mA		
Power dissipation	SOT-23-3	P _D	150 (When not mounted on board)	mW	
			430*3	mW	
			SOT-23-5	250 (When not mounted on board)	mW
				600*3	mW
				SOT-89-3	500 (When not mounted on board)
1000*3	mW				
Operating ambient temperature	T _{opr}	-40 to + 85	°C		
Storage temperature	T _{stg}	-40 to + 125	°C		

*1. With shutdown function

*2. For V_{DD} / V_{OUT} separate type

*3. When mounted on board

[Mounted board]

- (1) Board size : 114.3 mm × 76.2 mm × t1.6 mm
- (2) Board name : JEDEC STANDARD51-7

Caution The absolute maximum ratings are rated values exceeding which the product could suffer physical damage. These values must therefore not be exceeded under any conditions.

(1) When mounted on board

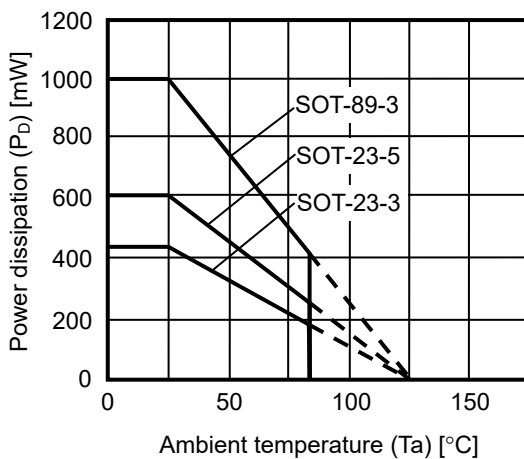

(2) When not mounted on board

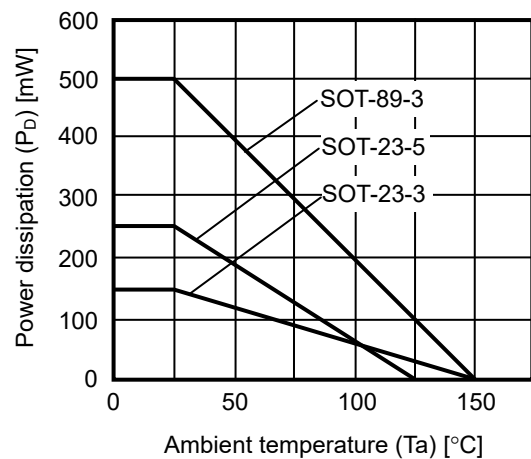

Figure 7 Power Dissipation of Packages

■ **Electrical Characteristics**

(1) 50 kHz Product (A and D Types)

Table 14

(Ta = 25°C unless otherwise specified)

Item	Symbol	Condition	Min.	Typ.	Max.	Unit	Measurement circuit	
Output voltage	V _{OUT}	–	V _{OUT(S)} × 0.976	V _{OUT(S)}	V _{OUT(S)} × 1.024	V	2	
Input voltage	V _{IN}	–	–	–	10	V	2	
Operation start voltage	V _{ST1}	I _{OUT} = 1 mA	–	–	0.9	V	2	
Oscillation start voltage	V _{ST2}	No external parts, Voltage applied to V _{OUT}	–	–	0.8	V	1	
Operation holding voltage	V _{HLD}	I _{OUT} = 1 mA, Judged by decreasing V _{IN} voltage gradually	0.7	–	–	V	2	
Current consumption 1	I _{SS1}	V _{OUT} = V _{OUT(S)} × 0.95	S-835xx15 to 19	–	10.8	18.0	μA	1
			S-835xx20 to 29	–	13.3	22.2	μA	1
			S-835xx30 to 39	–	18.7	31.1	μA	1
			S-835xx40 to 49	–	24.7	41.1	μA	1
			S-835xx50 to 59	–	31.0	51.6	μA	1
			S-835xx60 to 65	–	37.8	63.0	μA	1
Current consumption 2	I _{SS2}	V _{OUT} = V _{OUT(S)} + 0.5 V	S-835xx15 to 19	–	4.8	9.5	μA	1
			S-835xx20 to 29	–	5.0	9.9	μA	1
			S-835xx30 to 39	–	5.1	10.2	μA	1
			S-835xx40 to 49	–	5.3	10.6	μA	1
			S-835xx50 to 59	–	5.5	10.9	μA	1
			S-835xx60 to 65	–	5.7	11.3	μA	1
Current consumption during shutdown (With shutdown function)	I _{SSS}	V _{ON/OFF} = 0 V	–	–	0.5	μA	1	
Switching current	I _{SW}	V _{CONT} = 0.4 V	S-835xx15 to 19	80	128	–	mA	1
			S-835xx20 to 24	103	165	–	mA	1
			S-835xx25 to 29	125	200	–	mA	1
			S-835xx30 to 39	144	231	–	mA	1
			S-835xx40 to 49	176	282	–	mA	1
			S-835xx50 to 59	200	320	–	mA	1
			S-835xx60 to 65	215	344	–	mA	1
Switching transistor leakage current	I _{SWQ}	V _{CONT} = V _{OUT} = 10 V	–	–	0.5	μA	1	
Line regulation	ΔV _{OUT1}	V _{IN} = V _{OUT(S)} × 0.4 to × 0.6	–	30	60	mV	2	
Load regulation	ΔV _{OUT2}	I _{OUT} = 10 μA to V _{OUT(S)} / 250 × 1.25	–	30	60	mV	2	
Output voltage temperature coefficient	$\frac{\Delta V_{OUT}}{\Delta T_a \bullet V_{OUT}}$	Ta = –40°C to +85°C	–	±50	–	ppm / °C	2	
Oscillation frequency	f _{OSC}	V _{OUT} = V _{OUT(S)} × 0.95	42.5	50	57.5	kHz	1	
Maximum duty ratio	MaxDuty	V _{OUT} = V _{OUT(S)} × 0.95	75	83	90	%	1	
PWM / PFM switching duty ratio (For S-8354 Series)	PFMDuty	V _{IN} = V _{OUT(S)} – 0.1 V, No-load	10	15	24	%	1	
ON / OFF pin input voltage (With shutdown function)	V _{SH}	Measured oscillation at CONT pin	0.75	–	–	V	1	
	V _{SL1}	Judged oscillation stop at CONT pin	At V _{OUT} ≥ 1.5 V	–	–	0.3	V	1
	V _{SL2}		At V _{OUT} < 1.5 V	–	–	0.2	V	1
ON / OFF pin input current (With shutdown function)	I _{SH}	V _{ON/OFF} = V _{OUT(S)} × 0.95	–0.1	–	0.1	μA	1	
	I _{SL}	V _{ON/OFF} = 0 V	–0.1	–	0.1	μA	1	
Soft start time	t _{SS}	–	3.0	6.0	12.0	ms	2	
Efficiency	EFFI	–	–	85	–	%	2	

External parts

Coil: CDRH6D28-101 of Sumida Corporation

Diode: MA2Z748 (Schottky type) of Matsushita Electric Industrial Co., Ltd.

Capacitor: F93 (16 V, 22 μ F tantalum type) of Nichicon Corporation

$V_{IN} = V_{OUT(S)} \times 0.6$ applied, $I_{OUT} = V_{OUT(S)} / 250 \Omega$

With shutdown function : ON/ \overline{OFF} pin is connected to V_{OUT}

For V_{DD} / V_{OUT} separate type : V_{DD} pin is connected to V_{OUT} pin

- Remark**
1. $V_{OUT(S)}$ specified above is the set output voltage value, and V_{OUT} is the typical value of the actual output voltage.
 2. V_{DD} / V_{OUT} separate type
A step-up operation is performed from $V_{DD} = 0.8$ V. However, $1.8 \text{ V} \leq V_{DD} \leq 10$ V is recommended stabilizing the output voltage and oscillation frequency. ($V_{DD} \geq 1.8$ V must be applied for products with a set value of less than 1.9 V.)

(2) 30 kHz Product (C Type)

Table 15

(Ta = 25°C unless otherwise specified)

Item	Symbol	Condition	Min.	Typ.	Max.	Unit	Measurement circuit	
Output voltage	V _{OUT}	–	V _{OUT(S)} × 0.976	V _{OUT(S)}	V _{OUT(S)} × 1.024	V	2	
Input voltage	V _{IN}	–	–	–	10	V	2	
Operation start voltage	V _{ST1}	I _{OUT} = 1 mA	–	–	0.9	V	2	
Oscillation start voltage	V _{ST2}	No external parts, Voltage applied to V _{OUT}	–	–	0.8	V	1	
Operation holding voltage	V _{HLD}	I _{OUT} = 1 mA, Judged by decreasing V _{IN} voltage gradually	0.7	–	–	V	2	
Current consumption 1	I _{SS1}	V _{OUT} = V _{OUT(S)} × 0.95	S-835xx20 to 29	–	9.8	16.4	μA	1
			S-835xx30 to 39	–	13.1	21.9	μA	1
			S-835xx40 to 49	–	16.8	28.0	μA	1
			S-835xx50 to 59	–	20.7	34.5	μA	1
			S-835xx60 to 65	–	24.8	41.4	μA	1
Current consumption 2	I _{SS2}	V _{OUT} = V _{OUT(S)} + 0.5 V	S-835xx20 to 29	–	4.5	9.0	μA	1
			S-835xx30 to 39	–	4.7	9.4	μA	1
			S-835xx40 to 49	–	4.9	9.7	μA	1
			S-835xx50 to 59	–	5.1	10.1	μA	1
			S-835xx60 to 65	–	5.2	10.4	μA	1
Switching current	I _{SW}	V _{CONT} = 0.4 V	S-835xx20 to 24	52	83	–	mA	1
			S-835xx25 to 29	62	100	–	mA	1
			S-835xx30 to 39	72	115	–	mA	1
			S-835xx40 to 49	88	141	–	mA	1
			S-835xx50 to 59	100	160	–	mA	1
			S-835xx60 to 65	108	172	–	mA	1
Switching transistor leakage current	I _{SWQ}	V _{CONT} = V _{OUT} = 10 V	–	–	0.5	μA	1	
Line regulation	ΔV _{OUT1}	V _{IN} = V _{OUT(S)} × 0.4 to × 0.6	–	30	60	mV	2	
Load regulation	ΔV _{OUT2}	I _{OUT} = 10 μA to V _{OUT(S)} / 250 × 1.25	–	30	60	mV	2	
Output voltage temperature coefficient	$\frac{\Delta V_{OUT}}{\Delta T_a \bullet V_{OUT}}$	Ta = –40°C to +85°C	–	±50	–	ppm / °C	2	
Oscillation frequency	f _{OSC}	V _{OUT} = V _{OUT(S)} × 0.95	25	30	35	kHz	1	
Maximum duty ratio	MaxDuty	V _{OUT} = V _{OUT(S)} × 0.95	75	83	90	%	1	
PWM / PFM switching duty ratio (For S-8354 Series)	PFMDuty	V _{IN} = V _{OUT(S)} – 0.1 V, No-load	10	15	24	%	1	
Soft start time	t _{SS}	–	3.0	6.0	12.0	ms	2	
Efficiency	EFFI	–	–	84	–	%	2	

External parts

Coil: CDRH6D28-101 of Sumida Corporation

Diode: MA2Z748 (Schottky type) of Matsushita Electric Industrial Co., Ltd.

Capacitor: F93 (16 V, 22 μF tantalum type) of Nichicon Corporation

V_{IN} = V_{OUT(S)} × 0.6 applied, I_{OUT} = V_{OUT(S)} / 250 Ω

Remark V_{OUT(S)} specified above is the set output voltage value, and V_{OUT} is the typical value of the actual output voltage.

(3) 250 kHz Product (H and J Types)

Table 16

(Ta = 25°C unless otherwise specified)

Item	Symbol	Condition	Min.	Typ.	Max.	Unit	Measurement circuit	
Output voltage	V _{OUT}	–	V _{OUT(S)} × 0.976	V _{OUT(S)}	V _{OUT(S)} × 1.024	V	2	
Input voltage	V _{IN}	–	–	–	10	V	2	
Operation start voltage	V _{ST1}	I _{OUT} = 1 mA	–	–	0.9	V	2	
Oscillation start voltage	V _{ST2}	No external parts, Voltage applied to V _{OUT}	–	–	0.8	V	1	
Operation holding voltage	V _{HLD}	I _{OUT} = 1 mA, Judged by decreasing V _{IN} voltage gradually	0.7	–	–	V	2	
Current consumption 1	I _{SS1}	V _{OUT} = V _{OUT(S)} × 0.95	S-835xx15 to 19	–	36.5	60.8	μA	1
			S-835xx20 to 29	–	48.3	80.5	μA	1
			S-835xx30 to 39	–	74.3	123.8	μA	1
			S-835xx40 to 49	–	103.1	171.9	μA	1
			S-835xx50 to 59	–	134.1	223.5	μA	1
			S-835xx60 to 65	–	167.0	278.4	μA	1
Current consumption 2	I _{SS2}	V _{OUT} = V _{OUT(S)} + 0.5 V	S-835xx15 to 19	–	9.1	18.2	μA	1
			S-835xx20 to 29	–	9.3	18.6	μA	1
			S-835xx30 to 39	–	9.5	18.9	μA	1
			S-835xx40 to 49	–	9.7	19.3	μA	1
			S-835xx50 to 59	–	9.8	19.6	μA	1
			S-835xx60 to 65	–	10.0	19.9	μA	1
Current consumption during shutdown (With shutdown function)	I _{SSS}	V _{ON/OFF} = 0 V	–	–	0.5	μA	1	
Switching current	I _{SW}	V _{CONT} = 0.4 V	S-835xx15 to 19	80	128	–	mA	1
			S-835xx20 to 24	103	165	–	mA	1
			S-835xx25 to 29	125	200	–	mA	1
			S-835xx30 to 39	144	231	–	mA	1
			S-835xx40 to 49	176	282	–	mA	1
			S-835xx50 to 59	200	320	–	mA	1
			S-835xx60 to 65	215	344	–	mA	1
Switching transistor leakage current	I _{SWQ}	V _{CONT} = V _{OUT} = 10 V	–	–	0.5	μA	1	
Line regulation	ΔV _{OUT1}	V _{IN} = V _{OUT(S)} × 0.4 to × 0.6	–	30	60	mV	2	
Load regulation	ΔV _{OUT2}	I _{OUT} = 10 μA to V _{OUT(S)} / 250 × 1.25	–	30	60	mV	2	
Output voltage temperature coefficient	$\frac{\Delta V_{OUT}}{\Delta T_a \bullet V_{OUT}}$	Ta = –40°C to +85°C	–	±50	–	ppm / °C	2	
Oscillation frequency	f _{OSC}	V _{OUT} = V _{OUT(S)} × 0.95	212.5	250	287.5	kHz	1	
Maximum duty ratio	MaxDuty	V _{OUT} = V _{OUT(S)} × 0.95	70	78	85	%	1	
PWM / PFM switching duty ratio (For S-8354 Series)	PFMDuty	V _{IN} = V _{OUT(S)} – 0.1 V, No-load	10	15	24	%	1	
ON / $\overline{\text{OFF}}$ pin input voltage (With shutdown function)	V _{SH}	Measured oscillation at CONT pin	0.75	–	–	V	1	
	V _{SL1}	Judged oscillation stop at CONT pin	At V _{OUT} ≥ 1.5 V	–	–	0.3	V	1
	V _{SL2}		At V _{OUT} < 1.5 V	–	–	0.2	V	1
ON / $\overline{\text{OFF}}$ pin input current (With shutdown function)	I _{SH}	V _{ON/OFF} = V _{OUT(S)} × 0.95	–0.1	–	0.1	μA	1	
	I _{SL}	V _{ON/OFF} = 0 V	–0.1	–	0.1	μA	1	
Soft start time	t _{SS}	–	1.8	3.6	7.2	ms	2	
Efficiency	EFFI	–	–	85	–	%	2	

External parts

Coil: CDRH6D28-220 of Sumida Corporation

Diode: MA2Z748 (Schottky type) of Matsushita Electric Industrial Co., Ltd.

Capacitor: F93 (16 V, 22 μ F tantalum type) of Nichicon Corporation

$V_{IN} = V_{OUT(S)} \times 0.6$ applied, $I_{OUT} = V_{OUT(S)} / 250 \Omega$

With shutdown function : ON/ \overline{OFF} pin is connected to V_{OUT}

For V_{DD} / V_{OUT} separate type : V_{DD} pin is connected to V_{OUT} pin

- Remark**
1. $V_{OUT(S)}$ specified above is the set output voltage value, and V_{OUT} is the typical value of the actual output voltage.
 2. V_{DD} / V_{OUT} separate type
A step-up operation is performed from $V_{DD} = 0.8$ V. However, $1.8 \text{ V} \leq V_{DD} \leq 10 \text{ V}$ is recommended stabilizing the output voltage and oscillation frequency. ($V_{DD} \geq 1.8$ V must be applied for products with a set value of less than 1.9 V.)

■ Measurement Circuits

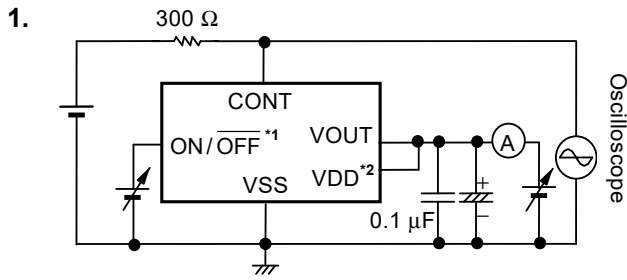

Figure 8



Figure 9

*1. With shutdown function

*2. For V_{DD} / V_{OUT} separate type

■ Operation

1. Switching Control Types

1.1 PWM Control (S-8353 Series)

The S-8353 Series is a DC-DC converter using a pulse width modulation method (PWM) and features low current consumption. In conventional PFM DC-DC converters, pulses are skipped when the output load current is low, causing a fluctuation in the ripple frequency of the output voltage, resulting in an increase in the ripple voltage.

In the S-8353 Series, the switching frequency does not change, although the pulse width changes from 0% to 83% (78% for H and J type) corresponding to each load current. The ripple voltage generated from switching can thus be removed easily using a filter because the switching frequency is constant.

1.2 PWM / PFM Switching Control (S-8354 Series)

The S-8354 Series is a DC-DC converter that automatically switches between a pulse width modulation method (PWM) and a pulse frequency modulation method (PFM), depending on the load current, and features low current consumption.

The S-8354 Series operates under PWM control with the pulse width duty changing from 15% to 83% (78% for H and J type) in a high output load current area. On the other hand, the S-8354 Series operates under PFM control with the pulse width duty fixed at 15% in a low output load current area, and pulses are skipped according to the load current. The oscillation circuit thus oscillates intermittently so that the resultant lower self current consumption can prevent a reduction in the efficiency at a low load current. The switching point from PWM control to PFM control depends on the external devices (coil, diode, etc.), input voltage, and output voltage. This series are an especially efficient DC-DC converter at an output current around 100 μ A.

2. Soft Start Function

For this IC, a built-in soft start circuit controls the rush current and overshoot of the output voltage when the power is turned on or the $\overline{\text{ON/OFF}}$ pin is set to "H" level.

3. ON/OFF Pin (Shutdown Pin) (SOT-23-5 Package Products of A and H Types)

ON/OFF pin stops or starts step-up operation.

Setting the ON/OFF pin to the “L” level stops operation of all the internal circuits and reduces the current consumption significantly.

DO NOT use the ON/OFF pin in a floating state because it has the structure shown in **Figure 10** and is not pulled up or pulled down internally. DO NOT apply a voltage of between 0.3 V and 0.75 V to the ON/OFF pin because applying such a voltage increases the current consumption. If the ON/OFF pin is not used, connect it to the VOUT pin.

The ON/OFF pin does not have hysteresis.

Table 17

ON/OFF pin	CR oscillation circuit	Output voltage
“H”	Operation	Fixed
“L”	Stop	$\approx V_{IN}^{*1}$

*1. Voltage obtained by subtracting the voltage drop due to the DC resistance of the inductor and the diode forward voltage from V_{IN} .

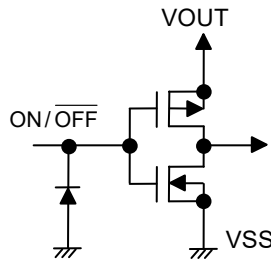

Figure 10 ON/OFF Pin Structure

4. Operation

The following are the basic equations [(1) through (7)] of the step-up switching regulator. (Refer to **Figure 11**.)

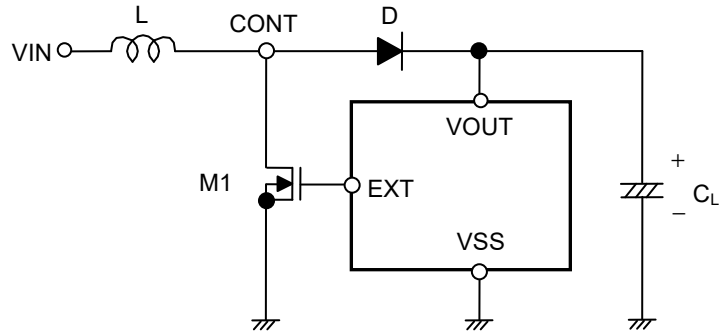

Figure 11 Step-Up Switching Regulator Circuit for Basic Equation

Voltage at CONT pin at the moment M1 is turned ON (V_A) *1 :

$$V_A = V_S \cdot 2 \dots\dots\dots (1)$$

- *1. Current flowing through L (I_L) is zero.
- *2. Non-saturated voltage of M1.

The change in I_L over time :

$$\frac{dI_L}{dt} = \frac{V_L}{L} = \frac{V_{IN} - V_S}{L} \dots\dots\dots (2)$$

Integration of equation (2) (I_L) :

$$I_L = \left(\frac{V_{IN} - V_S}{L} \right) \cdot t \dots\dots\dots (3)$$

I_L flows while M1 is ON (t_{ON}). The time of t_{ON} is determined by the oscillation frequency of OSC.

The peak current (I_{PK}) after t_{ON} :

$$I_{PK} = \left(\frac{V_{IN} - V_S}{L} \right) \cdot t_{ON} \dots\dots\dots (4)$$

The energy stored in L is represented by $1/2 \cdot L \cdot (I_{PK})^2$.

When M1 is turned OFF (t_{OFF}), the energy stored in L is emitted through a diode to the output capacitor.

Then, the reverse voltage (V_L) is generated :

$$V_L = (V_{OUT} + V_D \cdot 1) - V_{IN} \dots\dots\dots (5)$$

- *1. Diode forward voltage

The voltage at CONT pin rises only by $V_{OUT} + V_D$.

The change in the current (I_L) flowing through the diode into V_{OUT} during t_{OFF} :

$$\frac{dI_L}{dt} = \frac{V_L}{L} = \frac{V_{OUT} + V_D - V_{IN}}{L} \dots\dots\dots (6)$$

Integration of the equation (6) is as follows :

$$I_L = I_{PK} - \left(\frac{V_{OUT} + V_D - V_{IN}}{L} \right) \cdot t \dots\dots\dots (7)$$

During t_{ON} , the energy is stored in L and is not transmitted to V_{OUT} . When receiving the output current (I_{OUT}) from V_{OUT} , the energy of the capacitor (C_L) is consumed. As a result, the pin voltage of C_L is reduced, and goes to the lowest level after M1 is turned ON (t_{ON}). When M1 is turned OFF, the energy stored in L is transmitted through the diode to C_L , and the voltage of C_L rises rapidly. V_{OUT} is a time function, and therefore indicates the maximum value (ripple voltage (V_{P-P})) when the current flowing through into V_{OUT} and load current (I_{OUT}) match.

Next, the ripple voltage is determined as follows.

I_{OUT} vs. t_1 (time) from when M1 is turned OFF (after t_{ON}) to when V_{OUT} reaches the maximum level :

$$I_{OUT} = I_{PK} - \left(\frac{V_{OUT} + V_D - V_{IN}}{L} \right) \cdot t_1 \dots\dots\dots (8)$$

$$\therefore t_1 = (I_{PK} - I_{OUT}) \cdot \left(\frac{L}{V_{OUT} + V_D - V_{IN}} \right) \dots\dots\dots (9)$$

When M1 is turned OFF (t_{OFF}), $I_L = 0$ (when the energy of the inductor is completely transmitted). Based on equation (7) :

$$\left(\frac{L}{V_{OUT} + V_D - V_{IN}} \right) = \frac{t_{OFF}}{I_{PK}} \dots\dots\dots (10)$$

When substituting equation (10) for equation (9) :

$$t_1 = t_{OFF} - \left(\frac{I_{OUT}}{I_{PK}} \right) \cdot t_{OFF} \dots\dots\dots (11)$$

Electric charge ΔQ_1 which is charged in C_L during t_1 :

$$\Delta Q_1 = \int_0^{t_1} I_L dt = I_{PK} \cdot \int_0^{t_1} dt - \frac{V_{OUT} + V_D - V_{IN}}{L} \cdot \int_0^{t_1} t dt = I_{PK} \cdot t_1 - \frac{V_{OUT} + V_D - V_{IN}}{L} \cdot \frac{1}{2} t_1^2 \dots\dots\dots (12)$$

When substituting equation (12) for equation (9) :

$$\Delta Q_1 = I_{PK} - \frac{1}{2} (I_{PK} - I_{OUT}) \cdot t_1 = \frac{I_{PK} + I_{OUT}}{2} \cdot t_1 \dots\dots\dots (13)$$

A rise in voltage (V_{P-P}) due to ΔQ_1 :

$$V_{P-P} = \frac{\Delta Q_1}{C_L} = \frac{1}{C_L} \cdot \left(\frac{I_{PK} + I_{OUT}}{2} \right) \cdot t_1 \dots\dots\dots (14)$$

When taking into consideration I_{OUT} to be consumed during t_1 and the Equivalent Series Resistance (R_{ESR}) of C_L :

$$V_{P-P} = \frac{\Delta Q_1}{C_L} = \frac{1}{C_L} \cdot \left(\frac{I_{PK} + I_{OUT}}{2} \right) \cdot t_1 + \left(\frac{I_{PK} + I_{OUT}}{2} \right) \cdot R_{ESR} - \frac{I_{OUT} \cdot t_1}{C_L} \dots\dots\dots (15)$$

When substituting equation (11) for equation (15) :

$$V_{P-P} = \frac{(I_{PK} - I_{OUT})^2}{2I_{PK}} \cdot \frac{t_{OFF}}{C_L} + \left(\frac{I_{PK} + I_{OUT}}{2} \right) \cdot R_{ESR} \dots\dots\dots (16)$$

Therefore to reduce the ripple voltage, it is important that the capacitor connected to the output pin has a large capacity and a small R_{ESR} .

■ **External Parts Selection**

The relationship between the major characteristics of the step-up circuit and the characteristic parameters of the external parts is shown in **Figure 12**.

For larger output current ?	For higher efficiency ?		For smaller ripple voltage ?
	At PFM control	At PWM control	
Smaller inductance	Larger inductance		
Smaller direct current resistance of inductor			
Larger output capacitance			Larger output capacitance

Figure 12 Relationship between Major Characteristics of Step-up Circuit and External Parts

1. Inductor

The inductance value (L value) has a strong influence on the maximum output current (I_{OUT}) and efficiency (η). The peak current (I_{PK}) increases by decreasing L value and the stability of the circuit improves and I_{OUT} increases. If L value is decreased, the efficiency falls causing a decline in the current drive capacity for the switching transistor, and I_{OUT} decreases.

The loss of I_{PK} by the switching transistor decreases by increasing L and the efficiency becomes maximum at a certain L value. Further increasing L value decreases the efficiency due to the loss of the direct current resistance of the coil. I_{OUT} also decreases.

A higher oscillation frequency allows selection of a lower L value, making the coil smaller.

The recommended inductances are a 47 μ H to 220 μ H for A, C, and D types, a 10 μ H to 47 μ H for H and J types.

Be careful of the allowable inductor current when choosing an inductor. Exceeding the allowable current of the inductor causes magnetic saturation, much lower efficiency and destruction of the IC chip due to a large current.

Choose an inductor so that I_{PK} does not exceed the allowable current. I_{PK} in discontinuous mode is calculated by the following equation:

$$I_{PK} = \sqrt{\frac{2 I_{OUT} (V_{OUT} + V_D - V_{IN})}{f_{OSC} \cdot L}} \quad (A) \dots\dots\dots (17)$$

f_{OSC} = oscillation frequency, $V_D \cong 0.4$ V.

2. Diode

Use an external diode that meets the following requirements :

- Low forward voltage : $V_F < 0.3$ V
- High switching speed : 50 ns max.
- Reverse voltage : $V_{OUT} + V_F$ or more
- Current rate : I_{PK} or more

3. Capacitor (C_{IN}, C_L)

A capacitor on the input side (C_{IN}) improves the efficiency by reducing the power impedance and stabilizing the input current. Select a C_{IN} value according to the impedance of the power supply used.

A capacitor on the output side (C_L) is used for smoothing the output voltage. For step-up types, the output voltage flows intermittently to the load current, so step-up types need a larger capacitance than step-down types. Therefore, select an appropriate capacitor in accordance with the ripple voltage, which increases in case of a higher output voltage or a higher load current. The capacitor value should be 10 μF or more.

Select an appropriate capacitor the equivalent series resistance (R_{ESR}) for stable output voltage. The stable voltage range in this IC depends on the R_{ESR}. Although the inductance value (L value) is also a factor, an R_{ESR} of 30 Ω to 500 mΩ maximizes the characteristics. However, the best R_{ESR} value may depend on the L value, the capacitance, the wiring, and the applications (output load). Therefore, fully evaluate the R_{ESR} under the actual operating conditions to determine the best value.

Refer to the “1. Example of Ceramic Capacitor Application” (Figure 16) in the “■ Application Circuit” for the circuit example using a ceramic capacitor and the external resistance of the capacitor (R_{ESR}).

4. V_{DD} / V_{OUT} Separate Type (D and J Types)

The D and J types provides separate internal circuit power supply (V_{DD} pin) and output voltage setting pin (V_{OUT} pin) in the IC, making it ideal for the following applications.

- (1) When changing the output voltage with external resistance.
- (2) When outputting a high voltage within the operating voltage (10 V).

Choose the products in the **Table 18** according to the applications (1) or (2) above.

Table 18

Output voltage (V _{CC})	1.8 V ≤ V _{CC} < 5 V	5 V ≤ V _{CC} ≤ 10 V
S-835xx18	Yes	–
S-835xx50	–	Yes
Connection to V _{DD} pin	V _{IN} or V _{CC}	V _{IN}

Cautions 1. This IC starts a step-up operation at V_{DD} = 0.8 V, but set 1.8 ≤ V_{DD} ≤ 10 V to stabilize the output voltage and frequency of the oscillator. (Input a voltage of 1.8 V or more at the V_{DD} pin for all products with a setting less than 1.9 V.) An input voltage of 1.8 V or more at the V_{DD} pin allows connection of the V_{DD} pin to either the input voltage V_{IN} pin or output V_{OUT} pin.

2. Choose external resistors R_A and R_B so as to not affect the output voltage, considering that there is impedance between the V_{OUT} pin and V_{SS} pin in the IC chip. The internal resistance between the V_{OUT} pin and V_{SS} pin is as follows :

- (1) S-835xx18 : 2.1 MΩ to 14.8 MΩ
- (2) S-835xx20 : 1.4 MΩ to 14.8 MΩ
- (3) S-835xx30 : 1.4 MΩ to 14.2 MΩ
- (4) S-835xx50 : 1.4 MΩ to 12.1 MΩ

3. Attach a capacitor (C_c) in parallel to the R_A resistance when an unstable event such as oscillation of the output voltage occurs. Calculate C_c using the following equation :

$$C_c [F] = \frac{1}{2 \cdot \pi \cdot R_A \cdot 20 \text{ kHz}}$$

■ **Standard Circuits**

(1) S-8353AxxMA / UA, S-8353CxxMA, S-8353HxxMA/UA, S-8354AxxMA/UA, S-8354CxxMA, S-8354HxxMA / UA

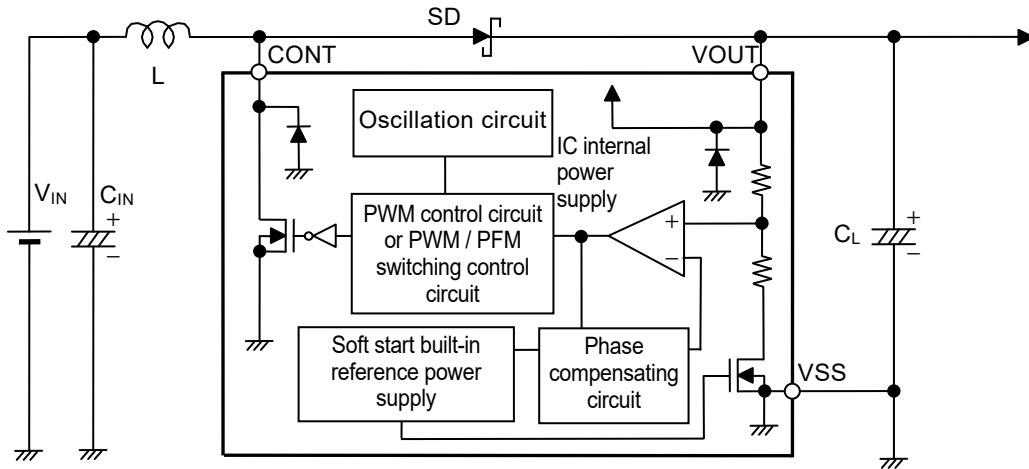

Remark The power supply for the IC chip is from the VOUT pin.

Figure 13

(2) S-8353AxxMC, S-8353HxxMC, S-8354AxxMC, S-8354HxxMC

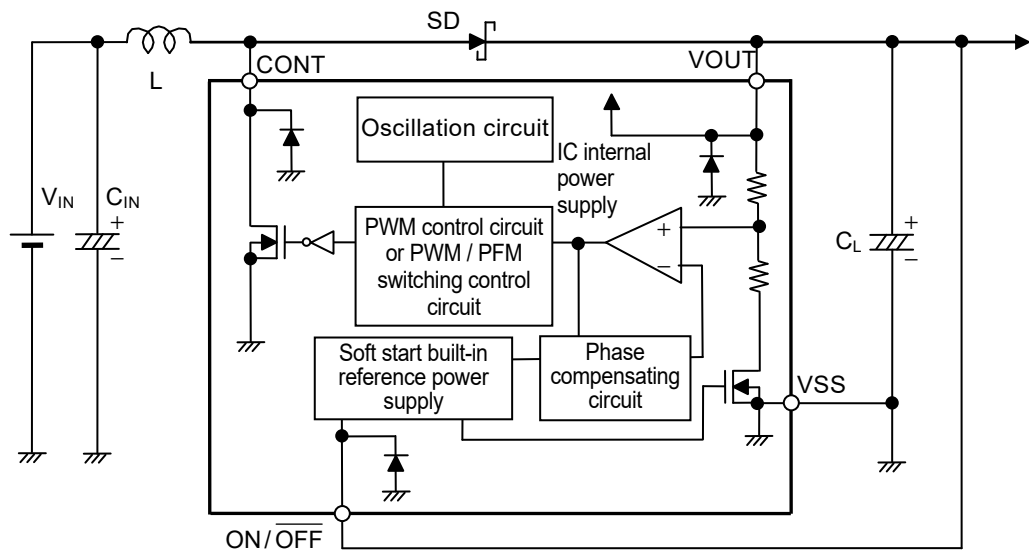

Remark The power supply for the IC chip is from the VOUT pin.

Figure 14

(3) S-8353DxxMC, S-8353JxxMC, S-8354DxxMC, S-8354JxxMC

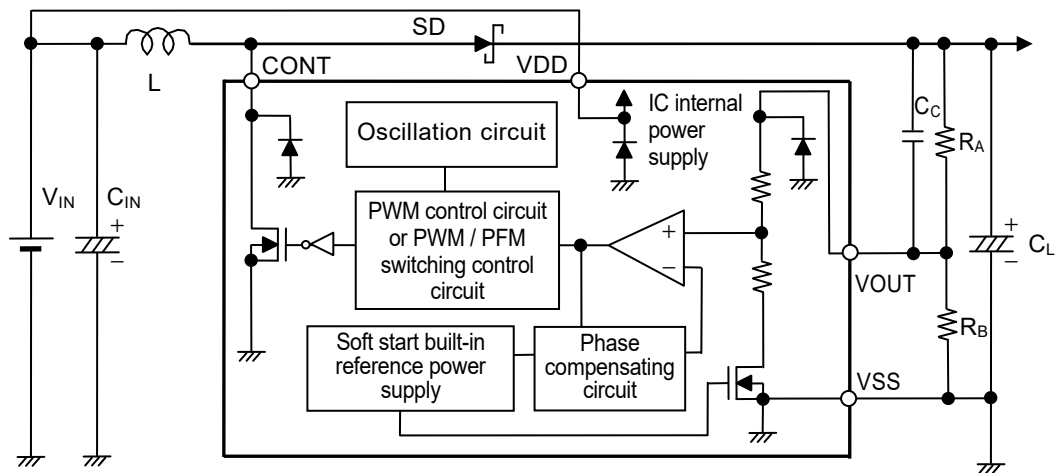

Remark The power supply for the IC chip is from the VOUT pin.

Figure 15

Caution The Above connection diagram will not guarantee successful operation. Perform through evaluation using the actual application to set the constant.

■ Precautions

- Mount external capacitors, diodes, and coils as close as possible to the IC. Especially, mounting the output capacitor (capacitor between V_{DD} pin and V_{SS} pin for V_{DD} / V_{OUT} separate type) in the power supply line of the IC close to the IC can enable stable output characteristics. If it is impossible, it is recommended to mount and wire a ceramic capacitor of around 0.1 μ F close to the IC.
- Characteristics ripple voltage and spike noise occur in IC containing switching regulators. Moreover rush current flows at the time of a power supply injection. Because these largely depend on the coil, the capacitor and impedance of power supply used, fully check them using an actually mounted model.
- Make sure that the dissipation of the switching transistor (especially at a high temperature) does not exceed the allowable power dissipation of the package.
- The performance of this IC varies depending on the design of the PCB patterns, peripheral circuits and external parts. Thoroughly test all settings with your device. The recommended external part should be used wherever possible, but if this is not possible for some reason, contact our sales representatives.
- Do not apply an electrostatic discharge to this IC that exceeds the performance ratings of the built-in electrostatic protection circuit.
- ABLIC Inc. claims no responsibility for any and all disputes arising out of or in connection with any infringement of the products including this IC upon patents owned a third party.

■ Application Circuits

1. Using Ceramic Capacitor Example

When using small R_{ESR} parts such as ceramic capacitors for the output capacitance, mount a resistor (R_1) corresponding to the R_{ESR} in series with the ceramic capacitor (C_L) as shown in **Figure 16**.

R_1 differs depending on L value, the capacitance, the wiring, and the application (output load).

The following example shows a circuit using $R_1 = 100\text{ m}\Omega$, output voltage = 3.3 V, output load = 100 mA and its characteristics.

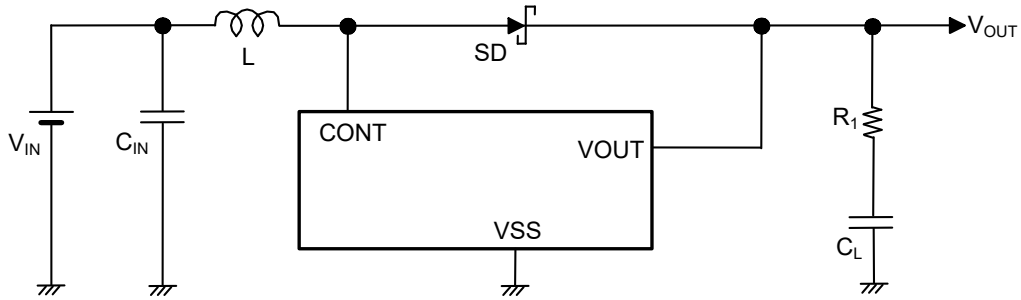

Figure 16 Using Ceramic Capacitor Circuit Example

Table 19

IC	L Type Name	SD Type Name	C_L (Ceramic capacitor)	R_1
S-8353A33	CDRH5D28-101	MA2Z748	10 $\mu\text{F} \times 2$	100 m Ω

Caution The Above connection diagram and constant will not guarantee successful operation. Perform through evaluation using the actual application to set the constant.

2. Output Characteristics of The Using Ceramic Capacitor Circuit Example

The data of the step-up characteristics (a) Output current (I_{OUT}) vs. Efficiency (η) characteristics, (b) Output current (I_{OUT}) vs. Output voltage (V_{OUT}) characteristics, (c) Output Current (I_{OUT}) vs. Ripple voltage (V_r) under conditions in **Table 19** is shown below.

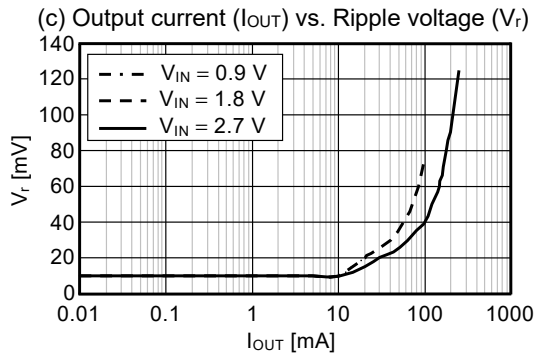
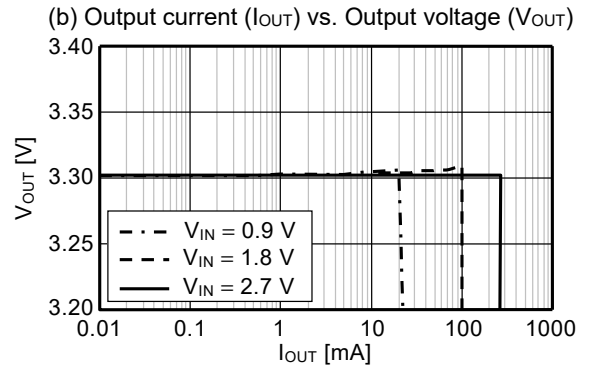
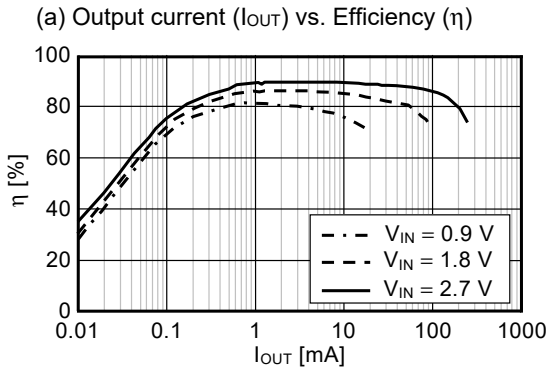

■ Characteristics (Typical Data)

1. Example of Major Temperature characteristics ($T_a = -40^{\circ}\text{C}$ to $+85^{\circ}\text{C}$, $V_{\text{OUT}} = 3.3\text{ V}$)

(1) Current Consumption 1 (I_{SS1}) vs. Temperature (T_a)

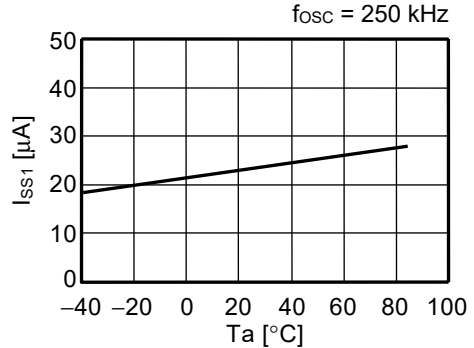
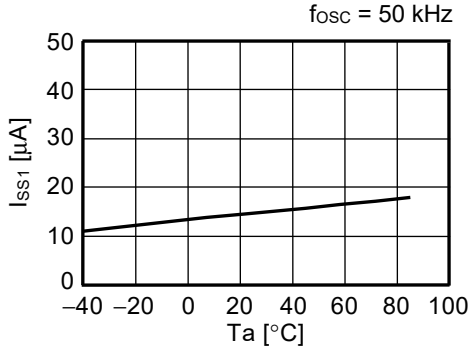

(2) Current Consumption 2 (I_{SS2}) vs. Temperature (T_a)

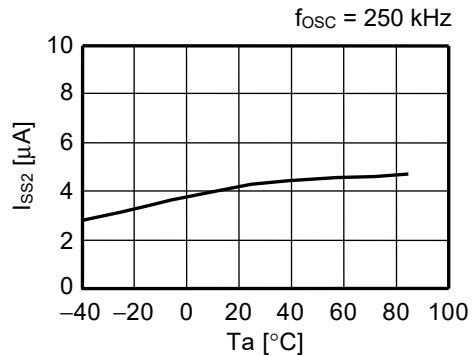

(3) Current Consumption at Shutdown (I_{SSS}) vs. Temperature (T_a)

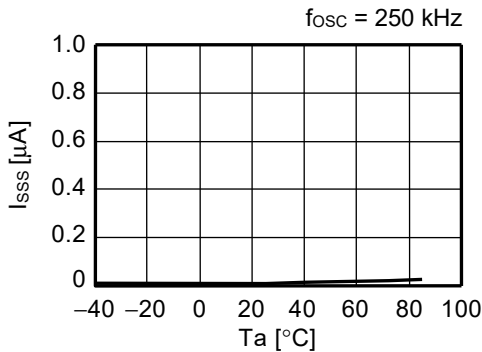

(4) Switching Current (I_{sw}) vs. Temperature (T_a)

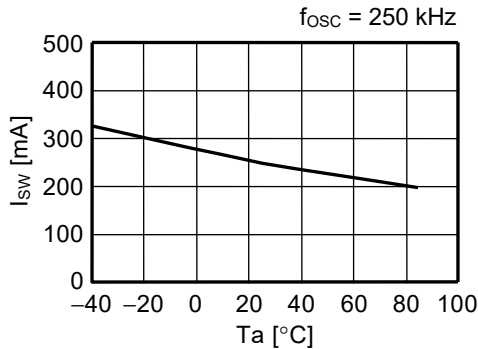

(5) Switching Transistor Leakage Current (I_{swQ}) vs. Temperature (T_a)

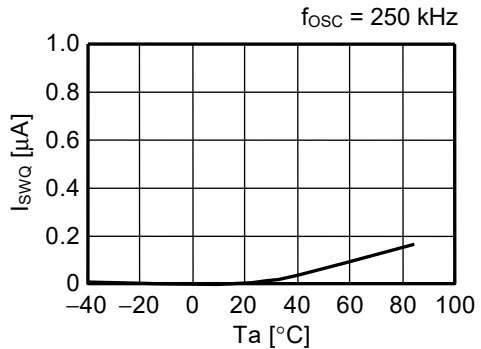

(6) Oscillation Frequency (f_{osc}) vs. Temperature (T_a)

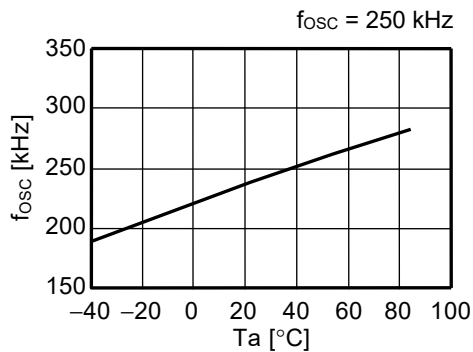
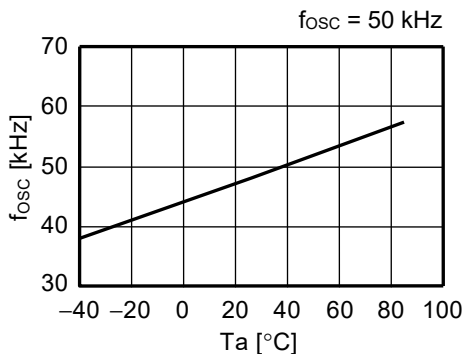

(7) Maximum Duty Ratio (MaxDuty) vs. Temperature (T_a)

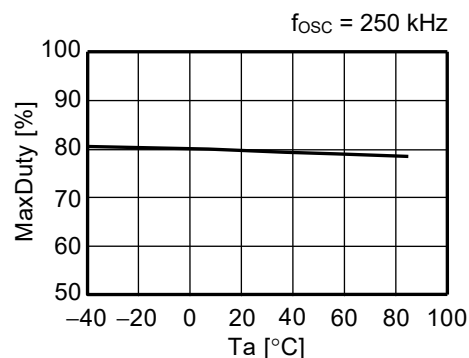
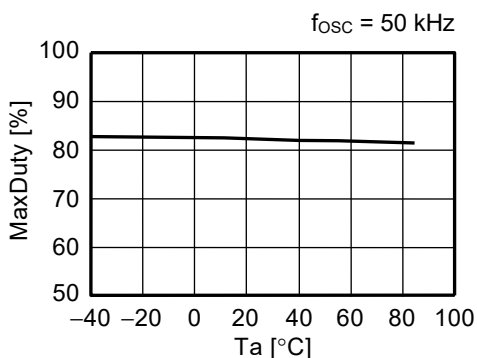

(8) PWM / PFM Switching Duty Ratio (PFMDuty) vs. Temperature (T_a) (S-8354 Series)

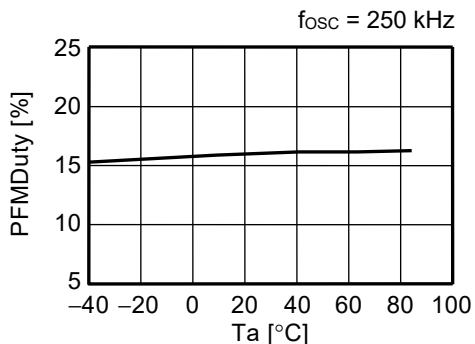

(9) ON/OFF Pin Input Voltage "H" (V_{SH}) vs. Temperature (T_a)

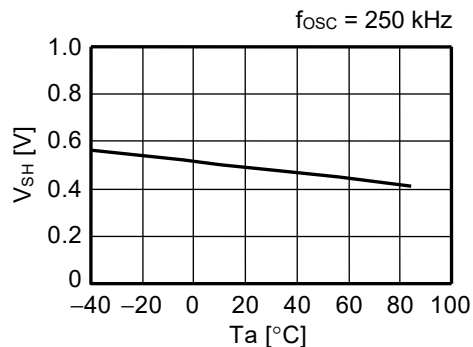

(10) ON/OFF Pin Input Voltage "L" 1 (V_{SL1}) vs. Temperature (T_a) (S-8354 Series)

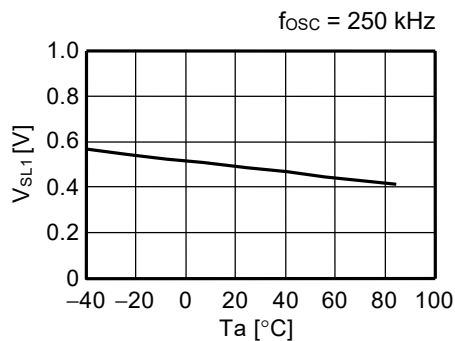

(11) ON/OFF Pin Input Voltage "L" 2 (V_{SL2}) vs. Temperature (T_a)

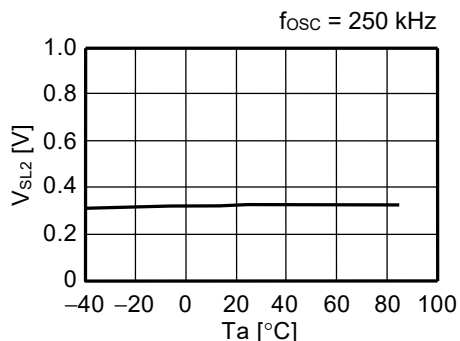

(12) Soft Start Time (t_{SS}) vs. Temperature (T_a)

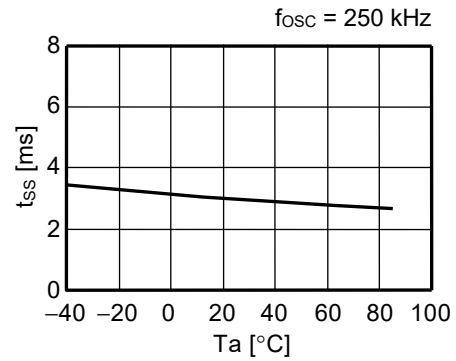

(13) Operation Start Voltage (V_{ST1}) vs. Temperature (T_a) **(14) Oscillation Start Voltage (V_{ST2}) vs. Temperature (T_a)**

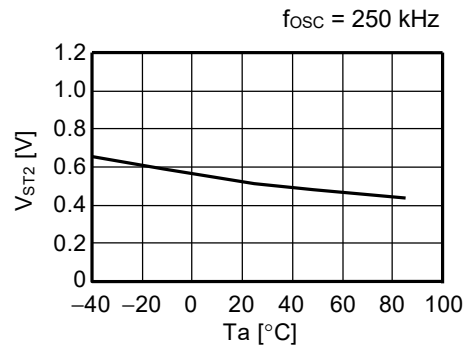

(15) Output Voltage (V_{OUT}) vs. Temperature (T_a)

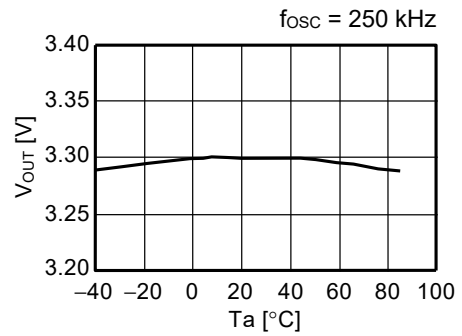

2. Examples of Major Power Supply Dependence Characteristics (Ta = 25°C)

**(1) Current Consumption 1 (Iss1) vs. Power Supply Voltage (VDD),
 Current Consumption 2 (Iss2) vs. Power Supply Voltage (VDD)**

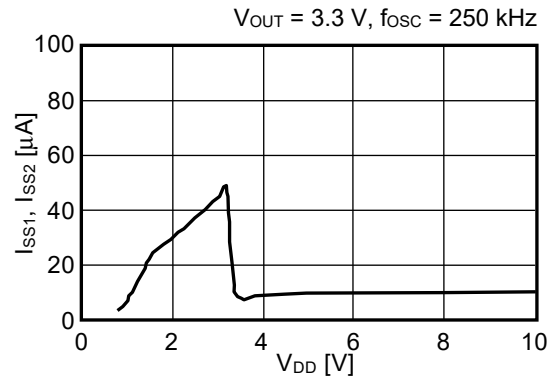
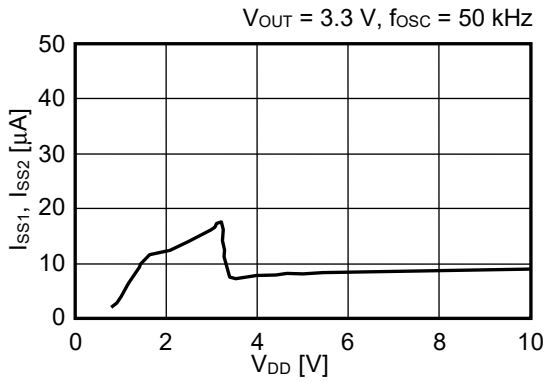

(2) Oscillation Frequency (fosc) vs. Power Supply Voltage (VDD)

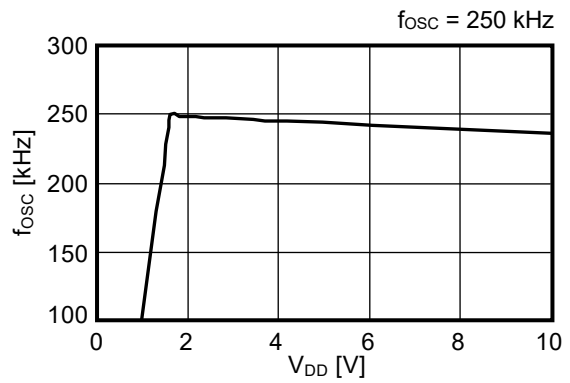
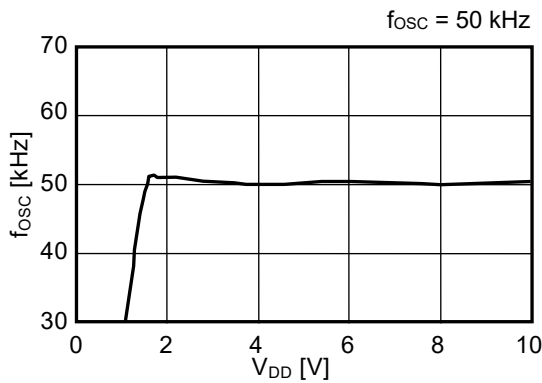

(3) Switching Current (Isw) vs. Power Supply Voltage (VDD)

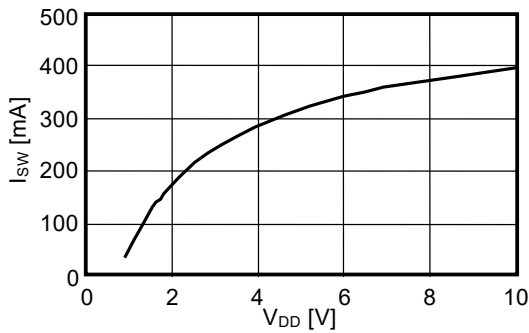

(4) Output Voltage (VOUT) vs. Power Supply Voltage (VDD) (VOUT = 3.3 V, VIN = 1.98 V, IOUT = 13.2 mA, VDD Separate Type)

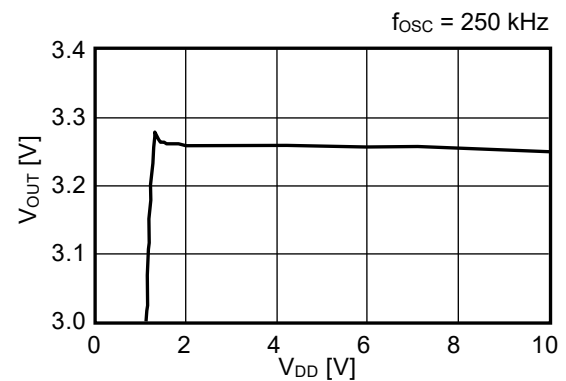
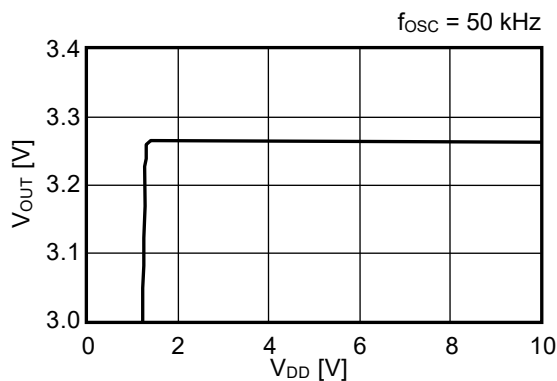

3. Output Waveforms ($V_{IN} = 1.98\text{ V}$)

(1) S-8353A33

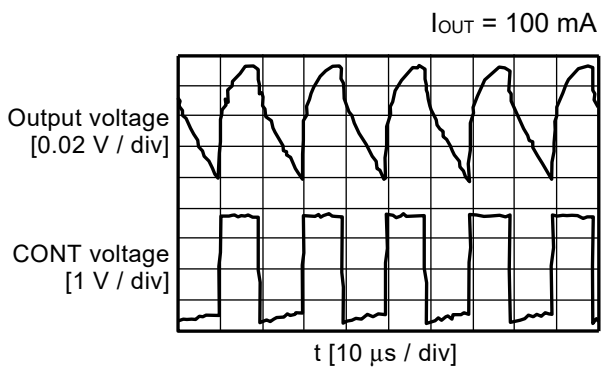
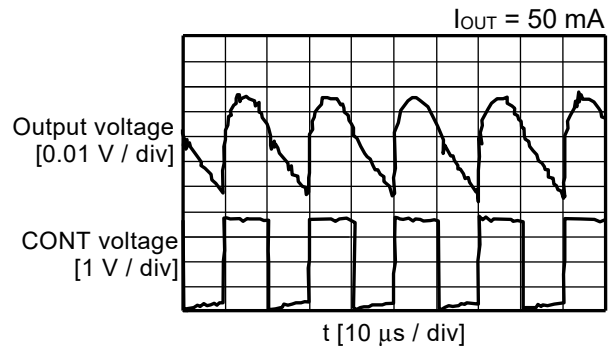
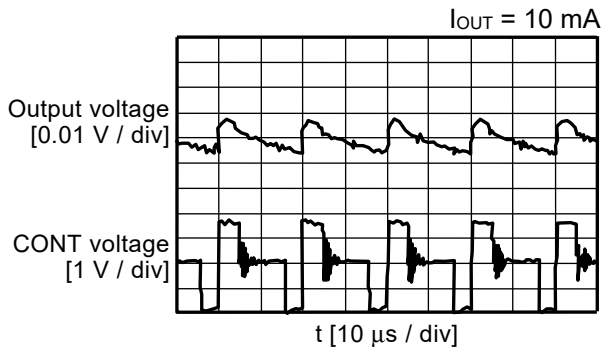

(2) S-8354H33

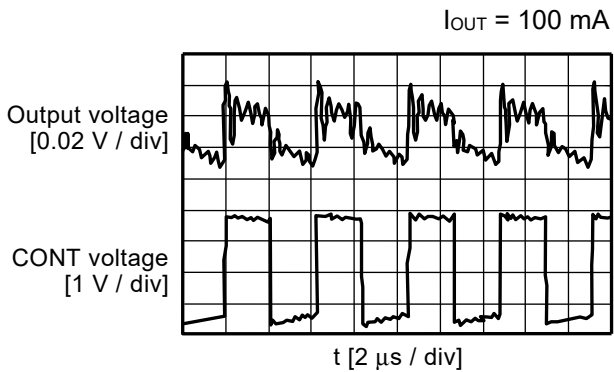
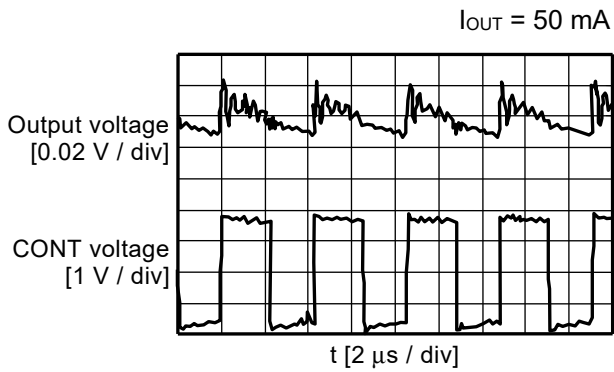
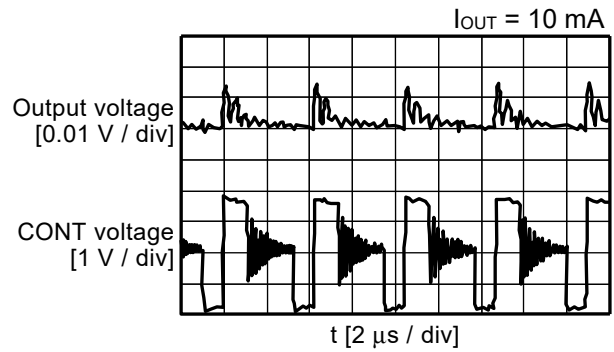
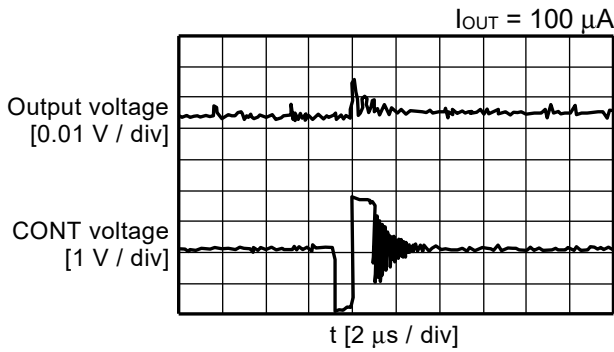

4. Examples of Transient Response Characteristics (Ta = 25°C, 250 kHz, S-8354H33)

(1) Power-On (VIN : 0 V → 2.0 V)

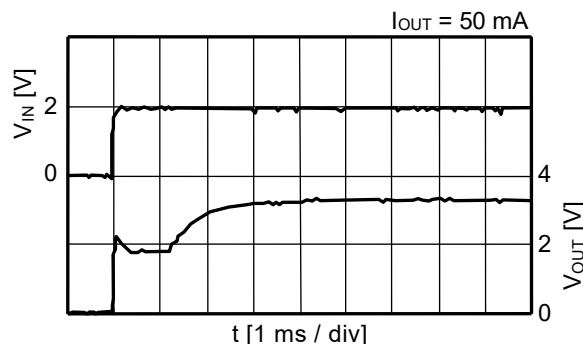
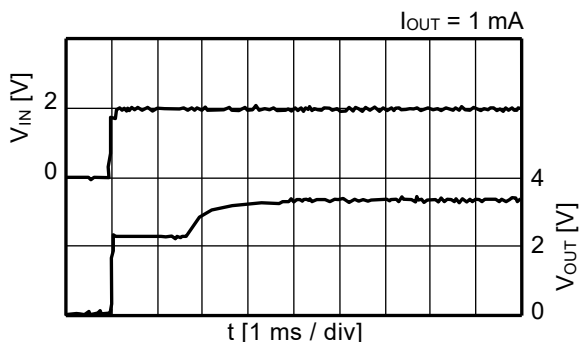

(2) ON/OFF Pin Response (VON/OFF : 0 V → 2.0 V, VIN = 2 V)

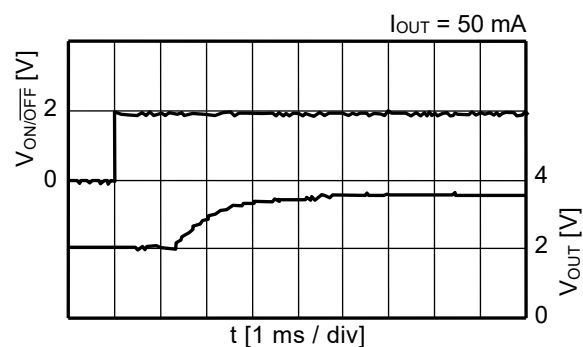
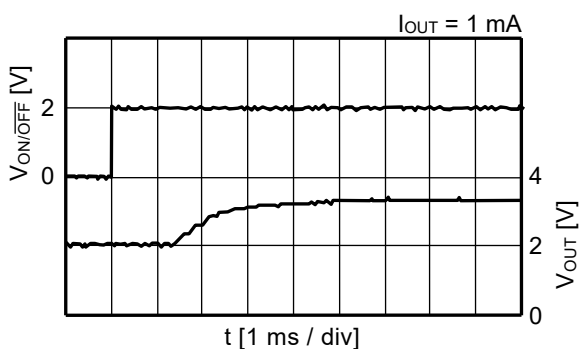

(3) Load Fluctuations (VIN = 1.98 V)

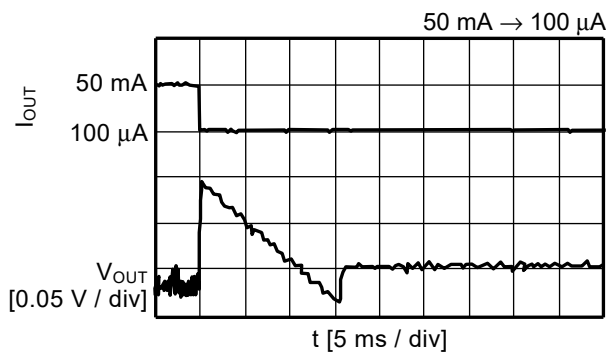
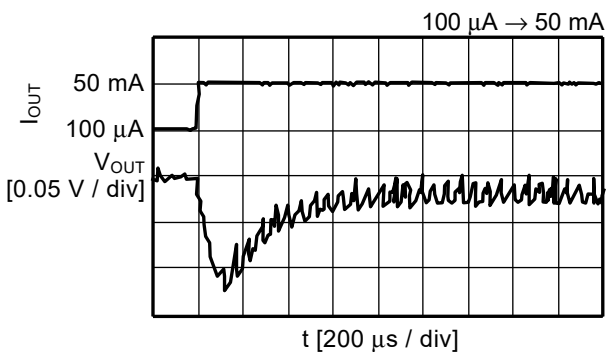

(4) Input Voltage Fluctuations (IOUT = 50 mA)

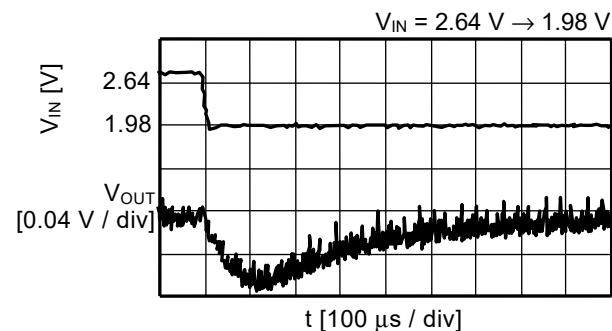
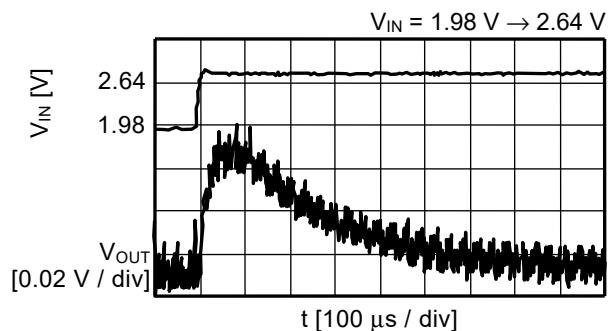

■ Reference Data

Reference data is provided to determine specific external components. Therefore, the following data shows the characteristics of the recommended external components selected for various applications.

1. External Parts for Reference Data

Table 20 Efficiency vs. Output Current Characteristics and Output Voltage vs. Output Current Characteristics for External Parts

Condition	Product Name	Oscillation frequency	Output voltage	Control system	Inductor	Diode	Output capacitor
1	S-8353H50MC	250 kHz	5.0 V	PWM	CDRH8D28-220	MA2Z748	F93 (16 V, 47 μ F)
2	S-8353H50MC	250 kHz	5.0 V	PWM	CDRH5D28-220		F93 (6.3 V, 22 μ F)
3	S-8353H50MC	250 kHz	5.0 V	PWM	CXLP120-220		F92 (6.3 V, 47 μ F)
4	S-8354A50MC	50 kHz	5.0 V	PWM / PFM	CDRH8D28-101		F93 (6.3 V, 22 μ F)
5	S-8354A50MC	50 kHz	5.0 V	PWM / PFM	CXLP120-470		F92 (6.3 V, 47 μ F)
6	S-8353A50MC	50 kHz	5.0 V	PWM	CDRH8D28-101		F93 (6.3 V, 22 μ F)
7	S-8353A50MC	50 kHz	5.0 V	PWM	CXLP120-470		F92 (6.3 V, 47 μ F)
8	S-8353A33MC	50 kHz	3.3 V	PWM	CDRH8D28-101		F93 (6.3 V, 22 μ F)

The properties of the external parts are shown below.

Table 21 Properties of External Parts

Component	Product name	Manufacturer	Characteristics
Inductor	CDRH8D28-220	Sumida Corporation	22 μ H, DCR*1 = 95 m Ω , I _{MAX} *2 = 1.6 A, Component height = 3.0 mm
	CDRH8D28-101		100 μ H, DCR*1 = 410 m Ω , I _{MAX} *2 = 0.75 A, Component height = 3.0 mm
	CDRH5D28-220		22 μ H, DCR*1 = 122 m Ω , I _{MAX} *2 = 0.9 A, Component height = 3.0 mm
	CXLP120-220	Sumitomo Special Metals Co., Ltd.	22 μ H, DCR*1 = 590 m Ω , I _{MAX} *2 = 0.55 A, Component height = 1.2 mm
	CXLP120-470		47 μ H, DCR*1 = 950 m Ω , I _{MAX} *2 = 0.45 A, Component height = 1.2 mm
Diode	MA2Z748	Matsushita Electric Industrial Co., Ltd.	V _F *3 = 0.4 V, I _F *4 = 0.3 A
Capacitor	F93 (16 V, 47 μ F)	Nichicon Corporation	-
	F93 (6.3 V, 22 μ F)		
	F92 (6.3 V, 47 μ F)		

- *1. Direct current resistance
- *2. Maximum allowable current
- *3. Forward voltage
- *4. Forward current

Caution The values shown in the characteristics column of Table 21 above are based on the materials provided by each manufacture. However, consider the characteristics of the original materials when using the above products.

2. Output Current (I_{OUT}) vs. Efficiency (η) Characteristics, Output Current (I_{OUT}) vs. Output Voltage (V_{OUT}) Characteristics

The following shows the actual (a) Output current (I_{OUT}) vs. Efficiency (η) characteristics and (b) Output current (I_{OUT}) vs. Output voltage (V_{OUT}) characteristics under the conditions of No. 1 to 8 in **Table 20**.

Condition 1 S-8353H50MC

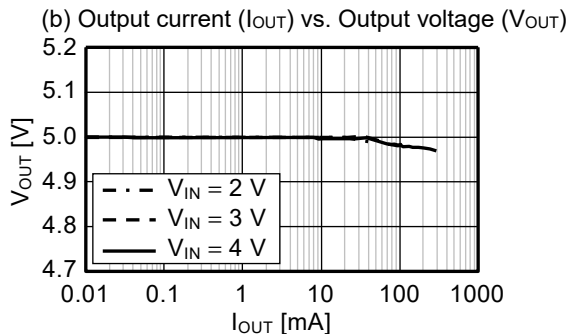
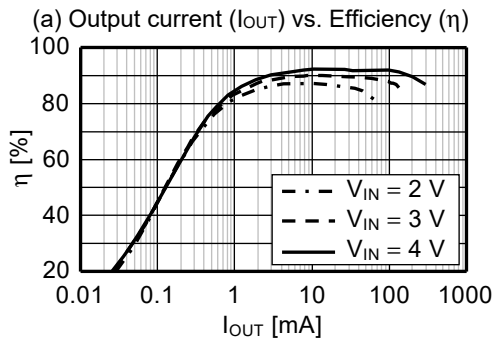

Condition 2 S-8353H50MC

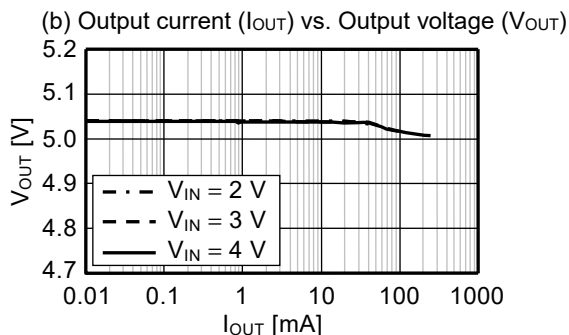
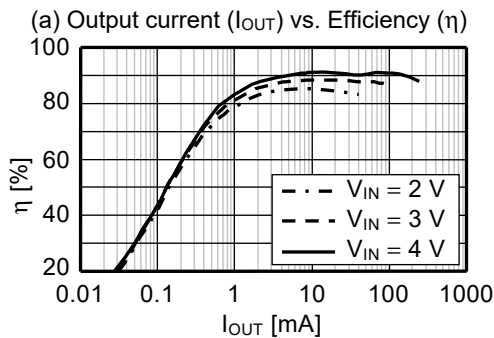

Condition 3 S-8353H50MC

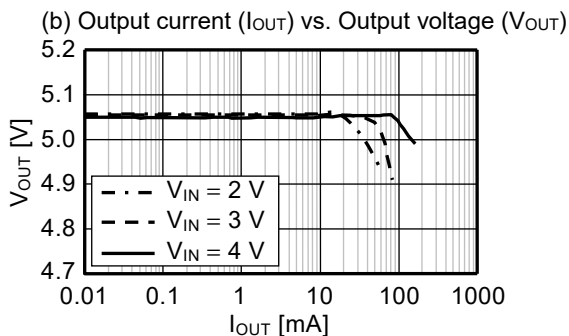
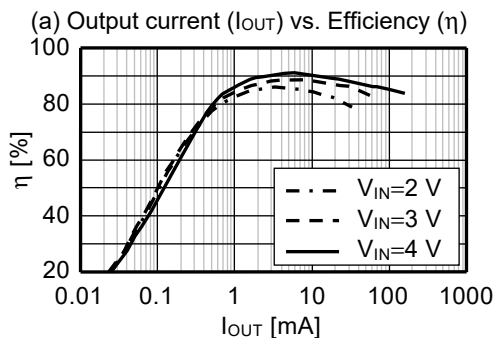

Condition 4 S-8354A50MC

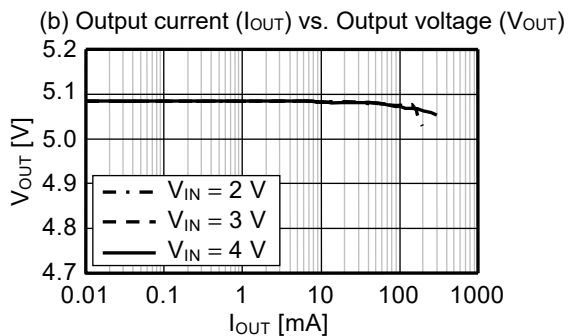
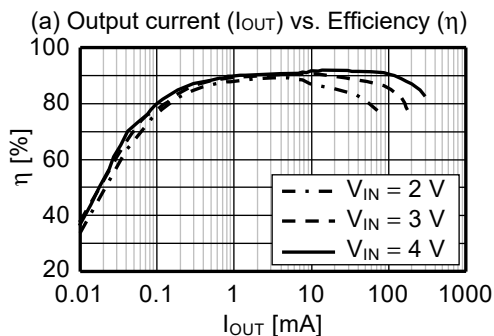

Condition 5 S-8354A50MC

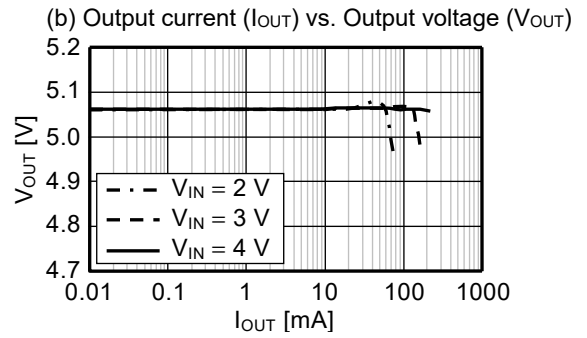
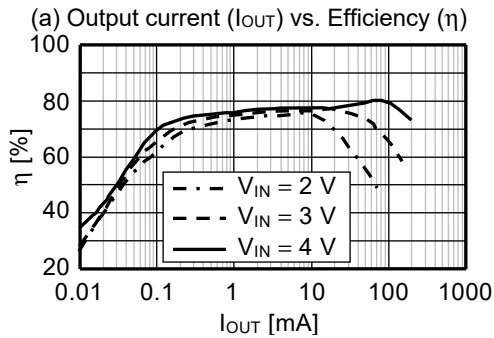

Condition 6 S-8353A50MC

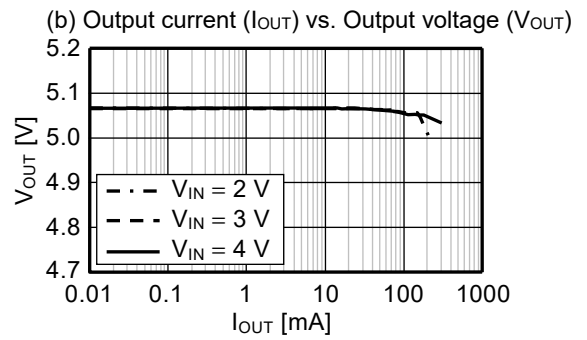

Condition 7 S-8353A50MC

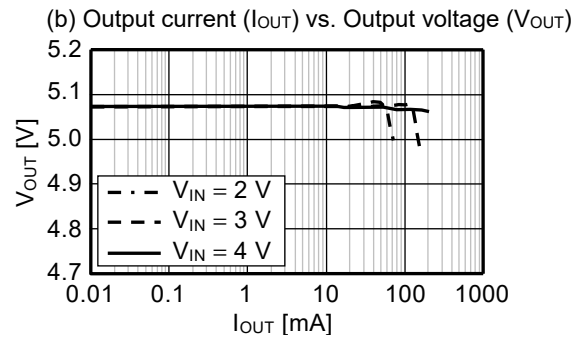
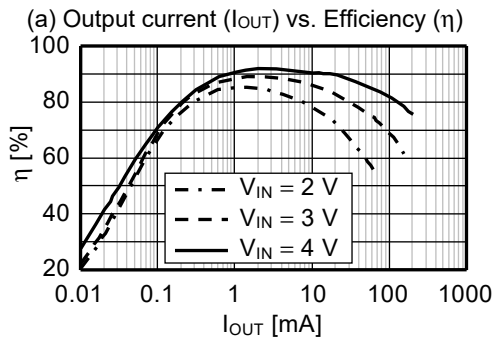

Condition 8 S-8353A33MC

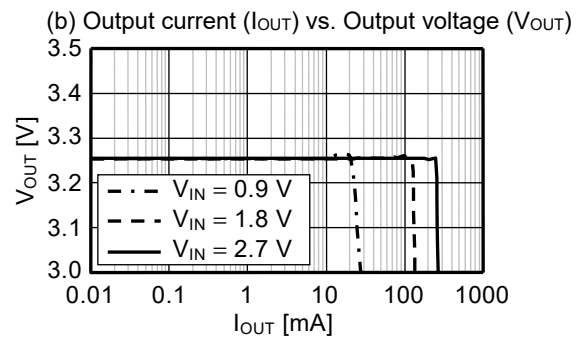

3. Output Current (I_{OUT}) vs. Ripple Voltage (V_r) Characteristics

The following shows the actual Output current (I_{OUT}) vs. Ripple voltage (V_r) characteristics and (b) Output current (I_{OUT}) vs. Output voltage (V_{OUT}) characteristics under the conditions of No. 1 to 8 in **Table 20**.

Condition 1 S-8353H50MC

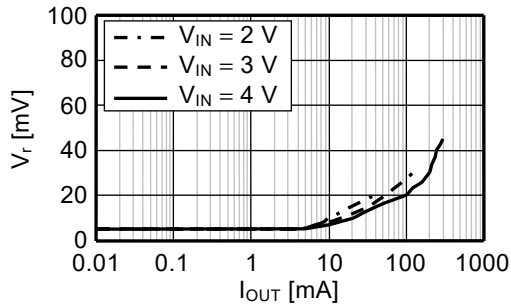

Condition 2 S-8353H50MC

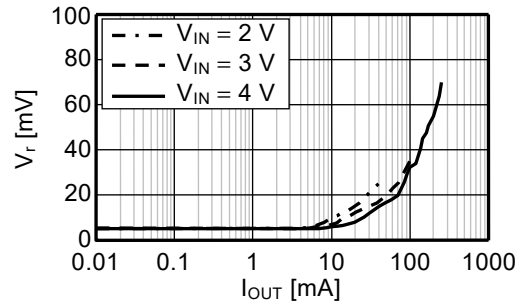

Condition 3 S-8353H50MC

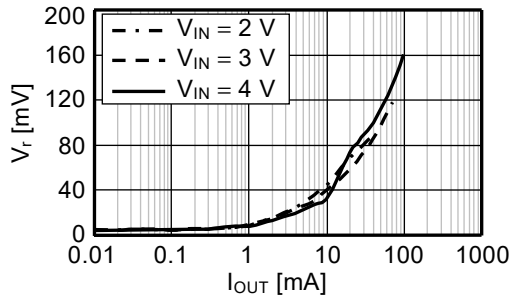

Condition 4 S-8354A50MC

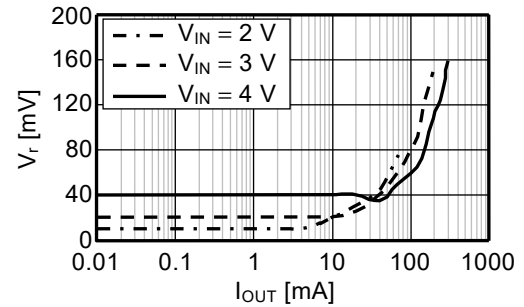

Condition 5 S-8354A50MC

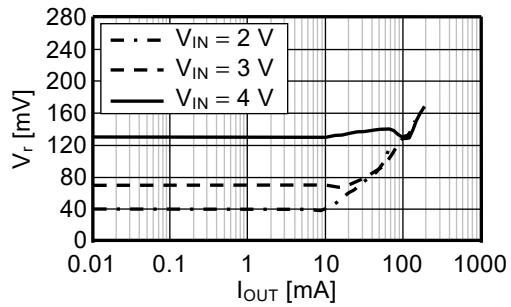

Condition 6 S-8353A50MC

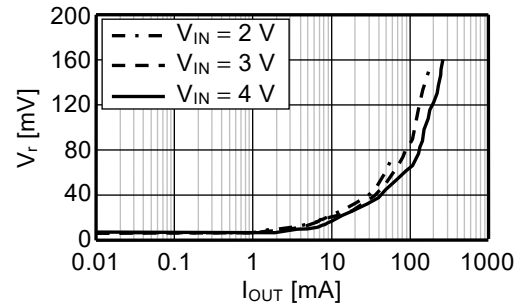

Condition 7 S-8353A50MC

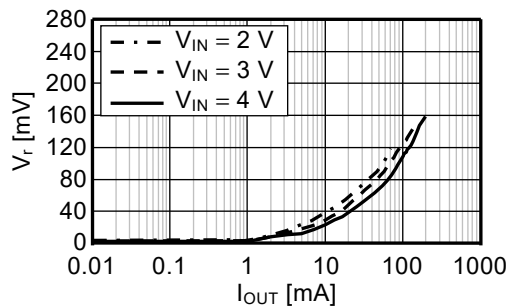

Condition 8 S-8353A33MC

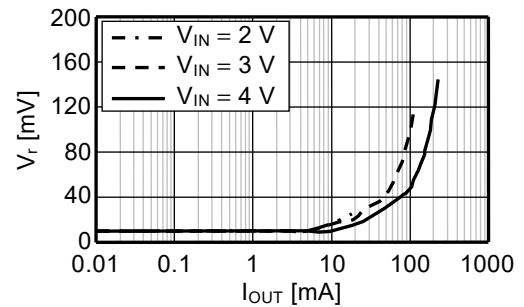

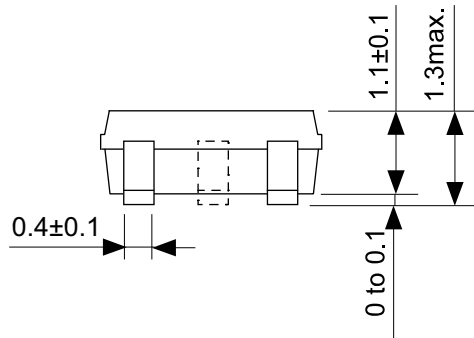
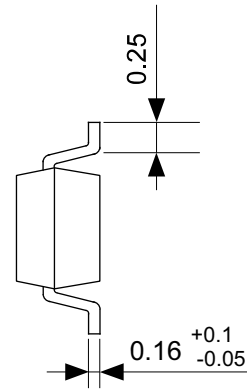

No. MP003-A-P-SD-1.2

TITLE	SOT233-A-PKG Dimensions
No.	MP003-A-P-SD-1.2
ANGLE	
UNIT	mm
ABLIC Inc.	

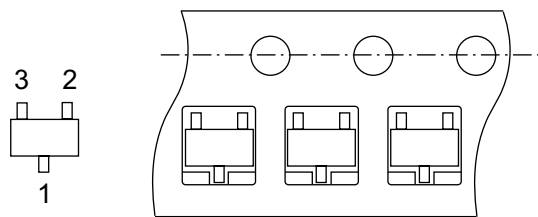
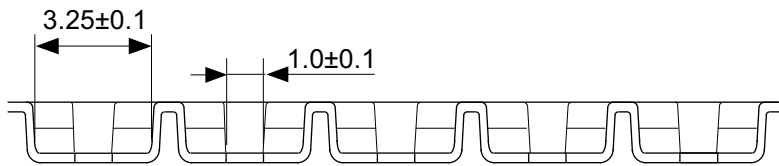

→
Feed direction

No. MP003-A-C-SD-2.0

TITLE	SOT233-A-Carrier Tape
No.	MP003-A-C-SD-2.0
ANGLE	
UNIT	mm
ABLIC Inc.	



Enlarged drawing in the central part

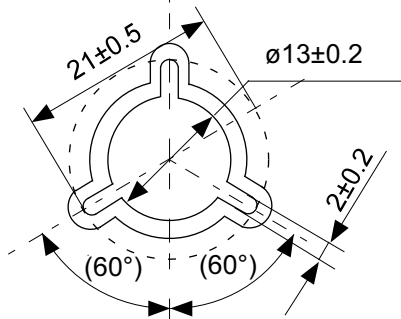

No. MP003-A-R-SD-1.1

TITLE	SOT233-A-Reel		
No.	MP003-A-R-SD-1.1		
ANGLE		QTY.	3,000
UNIT	mm		
ABLIC Inc.			

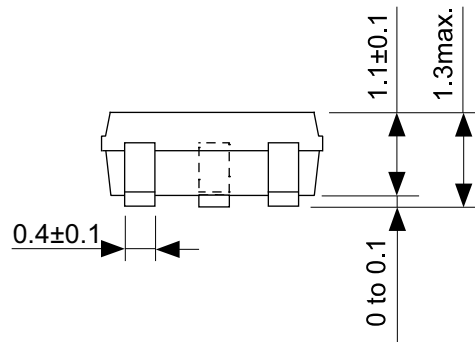
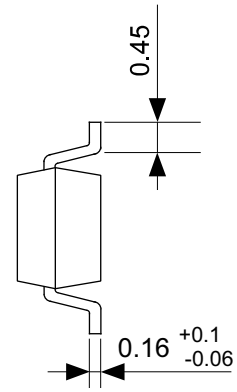

No. MP003-C-P-SD-1.1

TITLE	SOT233-C-PKG Dimensions
No.	MP003-C-P-SD-1.1
ANGLE	
UNIT	mm
ABLIC Inc.	

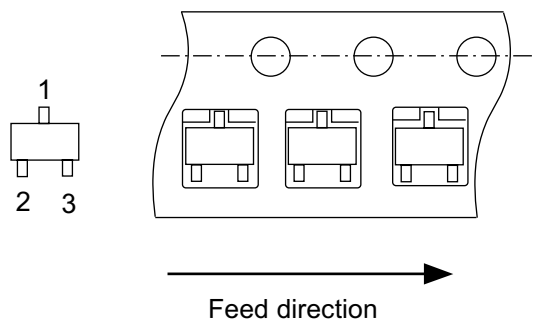

No. MP003-C-C-SD-2.0

TITLE	SOT233-C-Carrier Tape
No.	MP003-C-C-SD-2.0
ANGLE	
UNIT	mm
ABLIC Inc.	



Enlarged drawing in the central part



No. MP003-Z-R-SD-1.0

TITLE	SOT233-C-Reel		
No.	MP003-Z-R-SD-1.0		
ANGLE		QTY.	3,000
UNIT	mm		
ABLIC Inc.			



No. MP005-A-P-SD-1.3

TITLE	SOT235-A-PKG Dimensions
No.	MP005-A-P-SD-1.3
ANGLE	
UNIT	mm
ABLIC Inc.	



Feed direction →

No. MP005-A-C-SD-2.1

TITLE	SOT235-A-Carrier Tape
No.	MP005-A-C-SD-2.1
ANGLE	
UNIT	mm
ABLIC Inc.	



Enlarged drawing in the central part



No. MP005-A-R-SD-1.1

TITLE	SOT235-A-Reel		
No.	MP005-A-R-SD-1.1		
ANGLE		QTY.	3,000
UNIT	mm		
ABLIC Inc.			

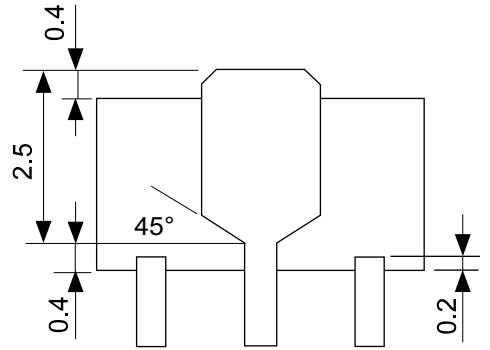

No. UP003-A-P-SD-2.0

TITLE	SOT893-A-PKG Dimensions
No.	UP003-A-P-SD-2.0
ANGLE	
UNIT	mm

ABLIC Inc.



Feed direction →

No. UP003-A-C-SD-2.0

TITLE	SOT893-A-Carrier Tape
No.	UP003-A-C-SD-2.0
ANGLE	
UNIT	mm
ABLIC Inc.	



Enlarged drawing in the central part

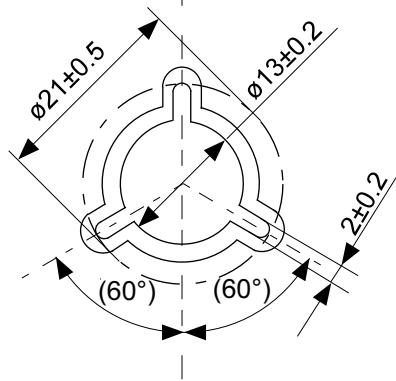

No. UP003-A-R-SD-1.1

TITLE	SOT893-A-Reel		
No.	UP003-A-R-SD-1.1		
ANGLE		QTY.	1,000
UNIT	mm		
ABLIC Inc.			

Disclaimers (Handling Precautions)

1. All the information described herein (product data, specifications, figures, tables, programs, algorithms and application circuit examples, etc.) is current as of publishing date of this document and is subject to change without notice.
2. The circuit examples and the usages described herein are for reference only, and do not guarantee the success of any specific mass-production design.
ABLIC Inc. is not liable for any losses, damages, claims or demands caused by the reasons other than the products described herein (hereinafter "the products") or infringement of third-party intellectual property right and any other right due to the use of the information described herein.
3. ABLIC Inc. is not liable for any losses, damages, claims or demands caused by the incorrect information described herein.
4. Be careful to use the products within their ranges described herein. Pay special attention for use to the absolute maximum ratings, operation voltage range and electrical characteristics, etc.
ABLIC Inc. is not liable for any losses, damages, claims or demands caused by failures and / or accidents, etc. due to the use of the products outside their specified ranges.
5. Before using the products, confirm their applications, and the laws and regulations of the region or country where they are used and verify suitability, safety and other factors for the intended use.
6. When exporting the products, comply with the Foreign Exchange and Foreign Trade Act and all other export-related laws, and follow the required procedures.
7. The products are strictly prohibited from using, providing or exporting for the purposes of the development of weapons of mass destruction or military use. ABLIC Inc. is not liable for any losses, damages, claims or demands caused by any provision or export to the person or entity who intends to develop, manufacture, use or store nuclear, biological or chemical weapons or missiles, or use any other military purposes.
8. The products are not designed to be used as part of any device or equipment that may affect the human body, human life, or assets (such as medical equipment, disaster prevention systems, security systems, combustion control systems, infrastructure control systems, vehicle equipment, traffic systems, in-vehicle equipment, aviation equipment, aerospace equipment, and nuclear-related equipment), excluding when specified for in-vehicle use or other uses by ABLIC, Inc. Do not apply the products to the above listed devices and equipments.
ABLIC Inc. is not liable for any losses, damages, claims or demands caused by unauthorized or unspecified use of the products.
9. In general, semiconductor products may fail or malfunction with some probability. The user of the products should therefore take responsibility to give thorough consideration to safety design including redundancy, fire spread prevention measures, and malfunction prevention to prevent accidents causing injury or death, fires and social damage, etc. that may ensue from the products' failure or malfunction.
The entire system in which the products are used must be sufficiently evaluated and judged whether the products are allowed to apply for the system on customer's own responsibility.
10. The products are not designed to be radiation-proof. The necessary radiation measures should be taken in the product design by the customer depending on the intended use.
11. The products do not affect human health under normal use. However, they contain chemical substances and heavy metals and should therefore not be put in the mouth. The fracture surfaces of wafers and chips may be sharp. Be careful when handling these with the bare hands to prevent injuries, etc.
12. When disposing of the products, comply with the laws and ordinances of the country or region where they are used.
13. The information described herein contains copyright information and know-how of ABLIC Inc. The information described herein does not convey any license under any intellectual property rights or any other rights belonging to ABLIC Inc. or a third party. Reproduction or copying of the information from this document or any part of this document described herein for the purpose of disclosing it to a third-party is strictly prohibited without the express permission of ABLIC Inc.
14. For more details on the information described herein or any other questions, please contact ABLIC Inc.'s sales representative.
15. This Disclaimers have been delivered in a text using the Japanese language, which text, despite any translations into the English language and the Chinese language, shall be controlling.

2.4-2019.07