

The S-8351/8352 Series is a CMOS step-up switching regulator controller which mainly consists of a reference voltage source, an oscillation circuit, a comparator and PFM control circuit. The PFM control circuit allows the duty ratio to be automatically switched according to the load (at light load : 50%, at high output current : 75%), enabling products with a low ripple over a wide range, high efficiency, and high output current (A, B, and D type). Products with a fixed duty ratio of 75% are also available (C type).

The S-8351 Series can configure a step-up switching regulator with an external coil, capacitor, and diode. A protection circuit turns off the built-in MOS FET when the voltage at the CONT pin exceeds the limit to prevent it from being damaged. In addition to the above features, the small package and low current consumption, makes the S-8351 Series ideal for applications such as the power supply unit of portable equipment.

The S-8352 Series, which features an external transistor, is suitable for applications requiring a high output current.

■ Features

- Low voltage operation : Startup at 0.9 V min. ($I_{OUT} = 1$ mA) guaranteed
- Low current consumption : During operation 23.2 μ A ($V_{OUT} = 3.3$ V, typ.)
During shutdown 0.5 μ A (max.)
- Duty ratio : 50 % / 75 % built-in auto-switching-type PFM control circuit (A, B, and D type)
75 % built-in fixed-type PFM control circuit (C type)
- External parts : Coil, capacitor, and diode
- Output voltage : Selectable in 0.1 V steps between 2.0 V to 6.5 V (A, B, and C type)
Selectable in 0.1 V steps between 1.5 V to 6.5 V (D type)
- Output voltage accuracy : $\pm 2.4\%$
- Shutdown function (A type)
- V_{DD} / V_{OUT} separate type (D type)
- External transistor type available (S-8352 Series)
- Lead-free, Sn 100%, halogen-free^{*1}

*1. Refer to "■ Product Name Structure" for details.

■ Applications

- Power supplies for portable equipment such as digital cameras, electronic notebooks, and PDAs
- Power supplies for audio equipment such as portable CD / MD players
- Constant voltage power supplies for cameras, video equipment, and communications equipment
- Power supplies for microcomputers

■ Packages

- SOT-23-3
- SOT-23-5
- SOT-89-3

■ **Block Diagrams**

1. **S-8351 Series**

(1) **A Type (With shutdown function)**



Figure 1

(2) **B and C Types (Without shutdown function, V_{DD} / V_{OUT} non-separate type)**

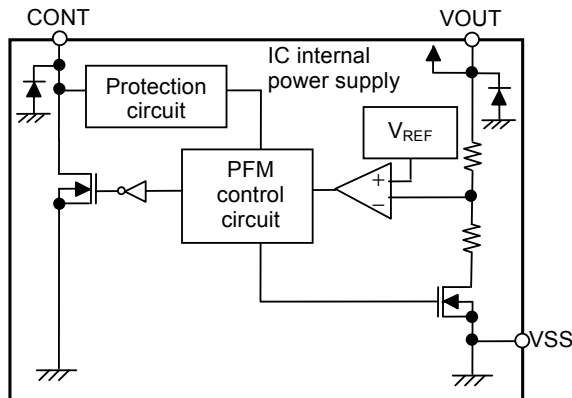

Figure 2

(3) **D Type (V_{DD} / V_{OUT} separate type)**

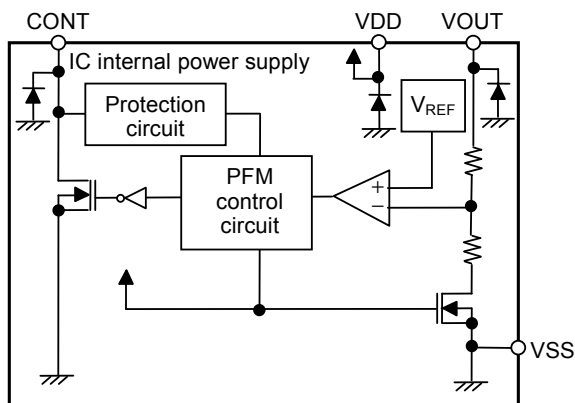

Figure 3

2. S-8352 Series

(1) A Type (With shutdown function)

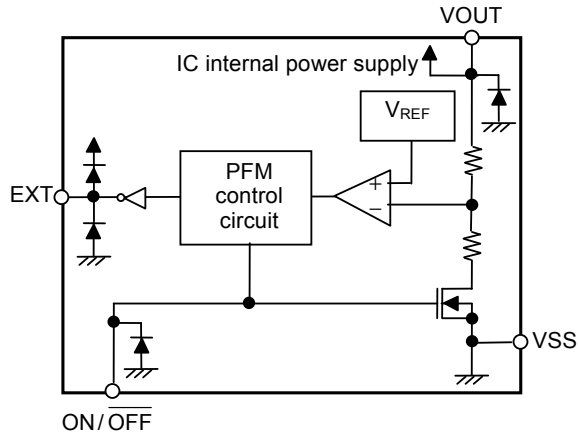

Figure 4

(2) B and C Type (Without Shutdown function, V_{DD} / V_{OUT} non-separate type)

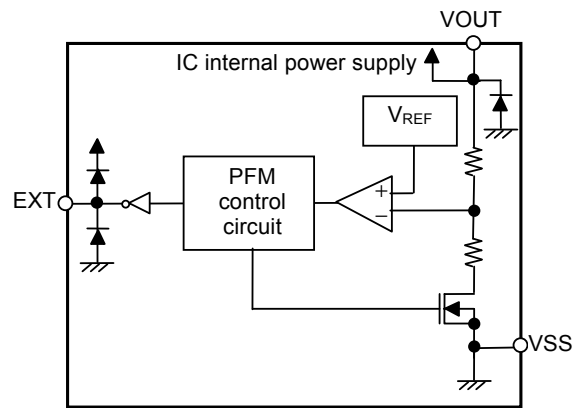

Figure 5

(3) D Type (V_{DD} / V_{OUT} separate type)

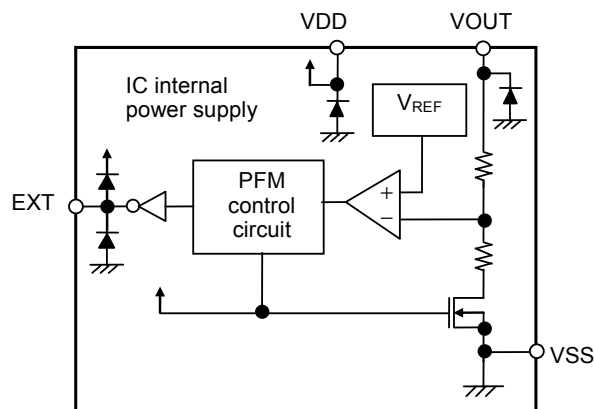

Figure 6

■ **Product Name Structure**

The product types, output voltage, and packages for the S-8351/8352 Series can be selected at the user's request. Please refer to the "3. Product Name" for the definition of the product name, "4. Package" regarding the package drawings and "5. Product Name List" for the full product names.

1. Function List

(1) Built-in Power MOS FET Type

Table 1

Product Name	Control system	Duty ratio [%]	Switching frequency [kHz]	Shutdown function	V _{DD} / V _{OUT} separate type	Package	Application
S-8351AxxMC	PFM	50 / 75	100	Yes	–	SOT-23-5	Applications requiring shutdown function
S-8351BxxMA	PFM	50 / 75	100	–	–	SOT-23-3	Applications not requiring shutdown function
S-8351CxxMA	PFM	75	100	–	–	SOT-23-3	Applications not requiring shutdown function
S-8351CxxUA	PFM	75	100	–	–	SOT-89-3	Applications not requiring shutdown function
S-8351DxxMC	PFM	50 / 75	100	–	Yes	SOT-23-5	Applications in which output voltage is adjusted by external resistor

(2) External Power MOS FET Type

Table 2

Product Name	Control System	Duty Ratio [%]	Switching Frequency [kHz]	Shutdown Function	V _{DD} / V _{OUT} Separate Type	Package	Application
S-8352AxxMC	PFM	50 / 75	100	Yes	–	SOT-23-5	Applications requiring shutdown function
S-8352BxxMA	PFM	50 / 75	100	–	–	SOT-23-3	Applications not requiring shutdown function
S-8352CxxMA	PFM	75	100	–	–	SOT-23-3	Applications not requiring shutdown function
S-8352CxxUA	PFM	75	100	–	–	SOT-89-3	Applications not requiring shutdown function
S-8352DxxMC	PFM	50 / 75	100	–	Yes	SOT-23-5	Applications in which output voltage is adjusted by external resistor

2. Package and Function List by Product Type

Table 3

Series Name	Type	Package Name (Abbreviation)	Shutdown Function Yes / No	V _{DD} / V _{OUT} Separate Type Yes / No
S-8351 Series, S-8352 Series	A (Duty ratio 50% / 75% auto-switching type) A = 100 kHz	MC	Yes	No
	B (Duty ratio 50% / 75% auto-switching type) B = 100 kHz	MA	No	No
	C (Duty ratio 75% fixed type) C = 100 kHz	MA / UA	No	No
	D (Duty ratio 50% / 75% auto-switching type) D = 100 kHz	MC	No	Yes

3. Product Name

(1) SOT-23-3

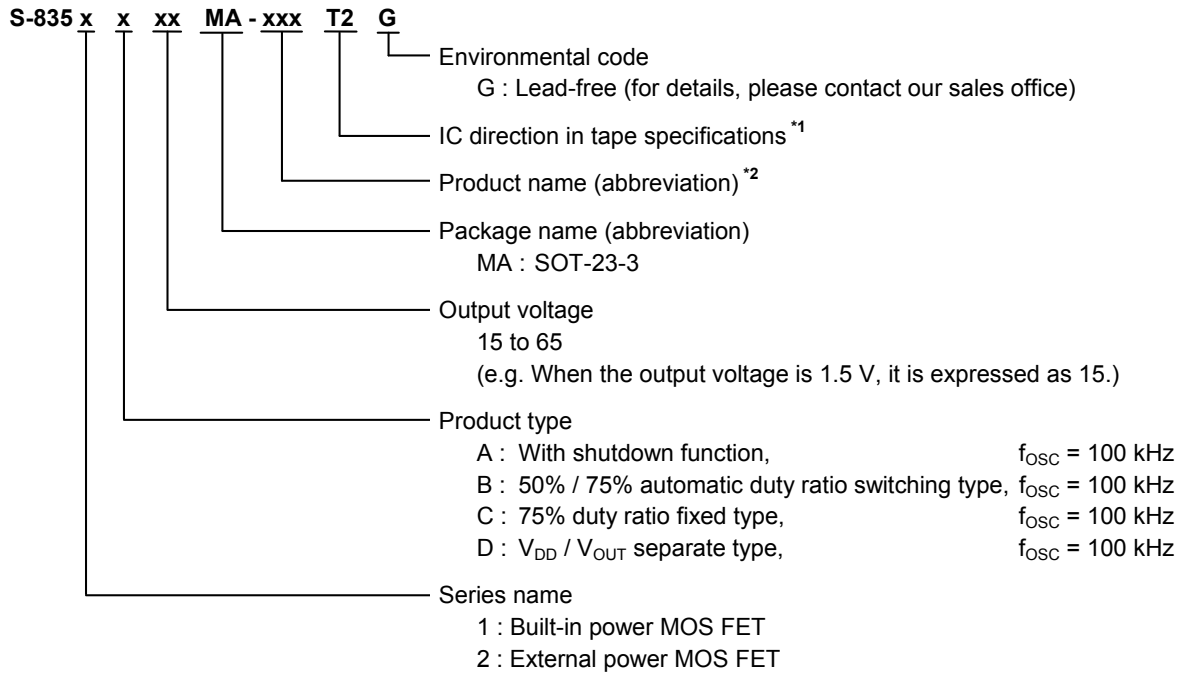

*1. Refer to the tape specifications.

*2. Refer to the **Table 4, 5** in the "**5. Product Name List**".

(2) SOT-23-5, SOT-89-3

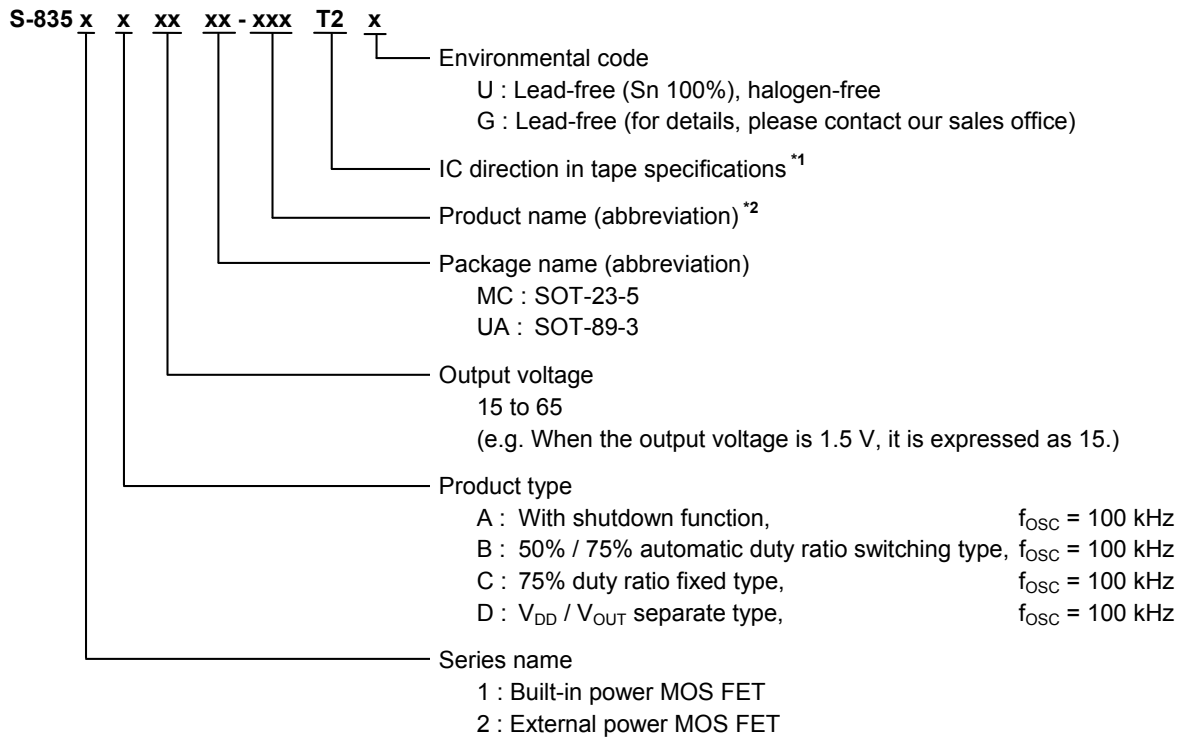

*1. Refer to the tape specifications.

*2. Refer to the **Table 4, 5** in the "**5. Product Name List**".

4. Package

Package Name	Drawing Code		
	Package	Tape	Reel
SOT-23-3	MP003-A-P-SD	MP003-A-C-SD	MP003-A-R-SD
SOT-23-5	MP005-A-P-SD	MP005-A-C-SD	MP005-A-R-SD
SOT-89-3	UP003-A-P-SD	UP003-A-C-SD	UP003-A-R-SD

5. Product Name List

(1) S-8351 Series

Table 4

Output voltage	S-8351AxxMC Series	S-8351BxxMA Series	S-8351CxxMA Series	S-8351CxxUA Series	S-8351DxxMC Series
1.5 V	-	-	-	-	S-8351D15MC-J8AT2x
2.0 V	S-8351A20MC-J2FT2x	S-8351B20MA-J4FT2G	-	-	S-8351D20MC-J8FT2x
2.2 V	S-8351A22MC-J2HT2x	-	-	-	-
2.5 V	S-8351A25MC-J2KT2x	S-8351B25MA-J4KT2G	-	S-8351C25UA-J6KT2x	-
2.6 V	S-8351A26MC-J2LT2x	-	-	-	-
2.7 V	S-8351A27MC-J2MT2x	S-8351B27MA-J4MT2G	-	-	-
2.8 V	S-8351A28MC-J2NT2x	-	-	-	-
3.0 V	S-8351A30MC-J2PT2x	S-8351B30MA-J4PT2G	-	S-8351C30UA-J6PT2x	S-8351D30MC-J8PT2x
3.1 V	-	-	-	S-8351C31UA-J6QT2x	-
3.2 V	S-8351A32MC-J2RT2x	-	-	S-8351C32UA-J6RT2x	-
3.3 V	S-8351A33MC-J2ST2x	S-8351B33MA-J4ST2G	S-8351C33MA-J6ST2G	S-8351C33UA-J6ST2x	-
3.5 V	S-8351A35MC-J2UT2x	-	-	S-8351C35UA-J6UT2x	-
4.0 V	S-8351A40MC-J2ZT2x	-	-	-	S-8351D40MC-J8ZT2x
4.5 V	S-8351A45MC-J3ET2x	S-8351B45MA-J5ET2G	-	-	-
4.6 V	-	S-8351B46MA-J5FT2G	-	-	-
4.7 V	S-8351A47MC-J3GT2x	-	-	-	-
5.0 V	S-8351A50MC-J3JT2x	S-8351B50MA-J5JT2G	-	S-8351C50UA-J7JT2x	S-8351D50MC-J9JT2x
5.5 V	S-8351A55MC-J3OT2x	S-8351B55MA-J5OT2G	-	-	-
5.6 V	S-8351A56MC-J3PT2x	-	-	-	-
6.0 V	S-8351A60MC-J3TT2x	-	-	-	S-8351D60MC-J9TT2x

(2) S-8352 Series

Table 5

Output voltage	S-8352AxxMC Series	S-8352BxxMA Series	S-8352CxxUA Series	S-8352DxxMC Series
2.0 V	-	-	-	S-8352D20MC-K8FT2x
2.5 V	S-8352A25MC-K2KT2x	-	-	-
3.0 V	S-8352A30MC-K2PT2x	S-8352B30MA-K4PT2G	S-8352C30UA-K6PT2x	S-8352D30MC-K8PT2x
3.1 V	-	-	S-8352C31UA-K6QT2x	-
3.2 V	S-8352A32MC-K2RT2x	-	S-8352C32UA-K6RT2x	-
3.3 V	S-8352A33MC-K2ST2x	-	S-8352C33UA-K6ST2x	S-8352D33MC-K8ST2x
3.5 V	S-8352A35MC-K2UT2x	-	-	-
3.7 V	S-8352A37MC-K2WT2x	-	-	-
4.0 V	S-8352A40MC-K2ZT2x	-	-	-
4.6 V	S-8352A46MC-K3FT2x	-	-	-
4.7 V	S-8352A47MC-K3GT2x	-	-	-
5.0 V	S-8352A50MC-K3JT2x	S-8352B50MA-K5JT2G	S-8352C50UA-K7JT2x	-
5.4 V	S-8352A54MC-K3NT2x	-	-	-
5.6 V	-	-	S-8352C56UA-K7PT2x	-

Remark 1. Please contact the ABLIC Inc. marketing department for products with an output voltage other than those specified above.

2. x: G or U

3. Please select products of environmental code = U for Sn 100%, halogen-free products.

■ Pin Configurations

SOT-23-3
Top view



Figure 7

Table 6 S-8351 Series B and C Types
(Without shutdown function, V_{DD} / V_{OUT} non-separate type)

Pin No.	Symbol	Pin Description
1	VOUT	Output voltage pin and IC power supply pin
2	VSS	GND pin
3	CONT	External inductor connection pin (Open-drain output)

Table 7 S-8352 Series B and C Types
(Without shutdown function, V_{DD} / V_{OUT} non-separate type)

Pin No.	Symbol	Pin Description
1	VOUT	Output voltage pin and IC power supply pin
2	VSS	GND pin
3	EXT	External transistor connection pin (CMOS output)

SOT-23-5
Top view



Figure 8

Table 8 S-8351 Series A Type
(With shutdown function, V_{DD} / V_{OUT} non-separate type)

Pin No.	Symbol	Pin Description
1	ON/ $\overline{\text{OFF}}$	Shutdown pin “H”: Normal operation (Step-up operating) “L”: Step-up stopped (Entire circuit stopped)
2	VOUT	Output voltage pin and IC power supply pin
3	NC ^{*1}	No connection
4	VSS	GND pin
5	CONT	External inductor connection pin (Open-drain output)

*1. The NC pin indicates electrically open.

Table 9 S-8352 Series A Type
(With shutdown function, V_{DD} / V_{OUT} non-separate type)

Pin No.	Symbol	Pin Description
1	ON/ $\overline{\text{OFF}}$	Shutdown pin “H”: Normal operation (Step-up operating) “L”: Step-up stopped (Entire circuit stopped)
2	VOUT	Output voltage pin and IC power supply pin
3	NC ^{*1}	No connection
4	VSS	GND pin
5	EXT	External transistor connection pin (CMOS output)

*1. The NC pin indicates electrically open.

Table 10 S-8351 Series D Type
 (Without shutdown function, V_{DD} / V_{OUT} separate type)

Pin No.	Symbol	Pin Description
1	VOUT	Output voltage pin
2	VDD	IC power supply pin
3	NC*1	No connection
4	VSS	GND pin
5	CONT	External inductor connection pin (Open-drain output)

*1. The NC pin indicates electrically open.

Table 11 S-8352 Series D Type
 (Without shutdown function, V_{DD} / V_{OUT} separate type)

Pin No.	Symbol	Pin Description
1	VOUT	Output voltage pin
2	VDD	IC power supply pin
3	NC*1	No connection
4	VSS	GND pin
5	EXT	External transistor connection pin (CMOS output)

*1. The NC pin indicates electrically open.

SOT-89-3
 Top view

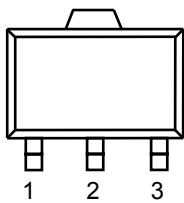

Figure 9

Table 12 S-8351 Series C Type
 (Without shutdown function, V_{DD} / V_{OUT} non-separate type)

Pin No.	Symbol	Pin Description
1	VSS	GND pin
2	VOUT	Output voltage pin and IC power supply pin
3	CONT	External inductor connection pin (Open-drain output)

Table 13 S-8352 Series C Type
 (Without shutdown function, V_{DD} / V_{OUT} non-separate type)

Pin No.	Symbol	Pin Description
1	VSS	GND pin
2	VOUT	Output voltage pin and IC power supply pin
3	EXT	External transistor connection pin (CMOS output)

■ **Absolute Maximum Ratings**

Table 14

(Ta = 25°C unless otherwise specified)

Item		Symbol	Absolute maximum rating	Unit
VOUT pin voltage		V _{OUT}	V _{SS} - 0.3 to V _{SS} + 12	V
ON/OFF pin voltage *1		V _{ON/OFF}	V _{SS} - 0.3 to V _{SS} + 12	V
VDD pin voltage *2		V _{DD}	V _{SS} - 0.3 to V _{SS} + 12	V
CONT pin voltage		V _{CONT}	V _{SS} - 0.3 to V _{SS} + 12	V
EXT pin voltage	D type	V _{EXT}	V _{SS} - 0.3 to V _{DD} + 0.3	V
	Others		V _{SS} - 0.3 to V _{OUT} + 0.3	V
CONT pin current		I _{CONT}	300	mA
EXT pin current		I _{EXT}	±50	mA
Power dissipation	SOT-23-3	P _D	150 (When not mounted on board)	mW
			430*3	mW
	SOT-23-5		250 (When not mounted on board)	mW
			600*3	mW
SOT-89-3	500 (When not mounted on board)	mW		
	1000*3	mW		
Operating ambient temperature		T _{opr}	- 40 to + 85	°C
Storage temperature		T _{stg}	- 40 to + 125	°C

*1. With shutdown function

*2. For V_{DD} / V_{OUT} separate type

*3. When mounted on board

[Mounted board]

(1) Board size : 114.3 mm × 76.2 mm × t1.6 mm

(2) Board name : JEDEC STANDARD51-7

Caution The absolute maximum ratings are rated values exceeding which the product could suffer physical damage. These values must therefore not be exceeded under any conditions.

(1) When mounted on board

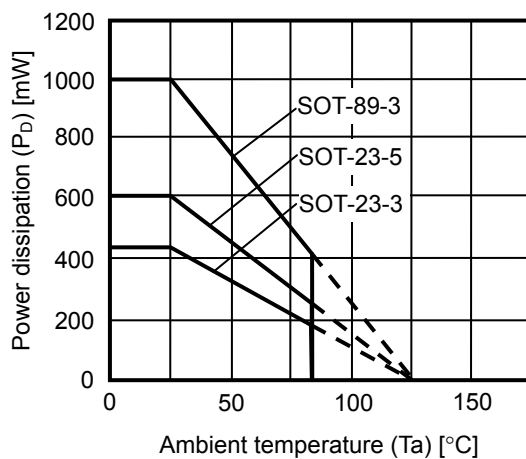

(2) When not mounted on board

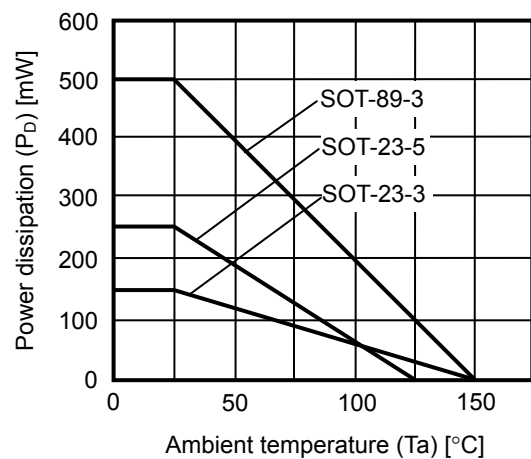

Figure 10 Power Dissipation of Packages

■ Electrical Characteristics

(1) S-8351 Series

Table 15 (1 / 2)

(Ta = 25°C unless otherwise specified)

Item	Symbol	Condition	Min.	Typ.	Max.	Unit	Measurement circuit	
Output voltage	V_{OUT}	–	$V_{OUT(S)} \times 0.976$	$V_{OUT(S)}$	$V_{OUT(S)} \times 1.024$	V	1	
Input voltage	V_{IN}	–	–	–	10	V	1	
Operation start voltage	V_{ST1}	$I_{OUT} = 1 \text{ mA}$	–	–	0.9	V	1	
Oscillation start voltage	V_{ST2}	No external parts, Voltage applied to V_{OUT} , CONT pin pulled up to V_{OUT} with 300 Ω resistor	–	–	0.8	V	2	
Input current during no- load	I_{IN}	$I_{OUT} = 0 \text{ mA}$	S-8351x15 to 29	–	8.5	–	μA	1
			S-8351x30 to 49	–	9.0	–	μA	1
			S-8351x50 to 65	–	9.5	–	μA	1
Current consumption 1	I_{SS1}	$V_{OUT} = V_{OUT(S)} \times 0.95$	S-8351x15 to 19	–	9.6	16.0	μA	2
			S-8351x20 to 29	–	15.7	26.2	μA	2
			S-8351x30 to 39	–	23.2	38.6	μA	2
			S-8351x40 to 49	–	32.0	53.3	μA	2
			S-8351x50 to 59	–	42.1	70.2	μA	2
			S-8351x60 to 65	–	54.9	91.5	μA	2
Current consumption 2	I_{SS2}	$V_{OUT} = V_{OUT(S)} + 0.5 \text{ V}$	S-8351x15 to 19	–	2.3	3.5	μA	2
			S-8351x20 to 29	–	2.5	3.8	μA	2
			S-8351x30 to 39	–	2.7	4.1	μA	2
			S-8351x40 to 49	–	2.9	4.4	μA	2
			S-8351x50 to 59	–	3.1	4.7	μA	2
			S-8351x60 to 65	–	3.3	5.1	μA	2
Current consumption during shutdown (With shutdown function)	I_{SSS}	$V_{ON/OFF} = 0 \text{ V}$	–	–	0.5	μA	2	
Switching current	I_{SW}	$V_{CONT} = 0.4 \text{ V}$	S-8351x15 to 19	50.2	91.2	–	mA	2
			S-8351x20 to 24	65.0	118.2	–	mA	2
			S-8351x25 to 29	78.5	142.7	–	mA	2
			S-8351x30 to 39	90.7	164.8	–	mA	2
			S-8351x40 to 49	110.9	201.6	–	mA	2
			S-8351x50 to 59	125.7	228.6	–	mA	2
			S-8351x60 to 65	135.2	245.8	–	mA	2
Switching transistor leakage current	I_{SWQ}	No external parts, $V_{CONT} = V_{OUT} = 10 \text{ V}$, $V_{ON/OFF} = 0 \text{ V}$	–	–	0.5	μA	2	
CONT pin limit voltage	$V_{CONTLMT}$	Apply to CONT pin, Confirm oscillation stop	–	0.9	–	V	2	
Line regulation	ΔV_{OUT1}	$V_{IN} = V_{OUT(S)} \times 0.4 \text{ to } \times 0.6$	–	30	60	mV	1	
Load regulation	ΔV_{OUT2}	$I_{OUT} = 10 \mu\text{A to } V_{OUT(S)} / 250 \times 1.25$	–	30	60	mV	1	
Output voltage temperature coefficient	$\frac{\Delta V_{OUT}}{\Delta T_a \bullet V_{OUT}}$	Ta = – 40°C to + 85°C	–	±50	–	ppm / °C	1	
Oscillation frequency	f_{OSC}	$V_{OUT} = V_{OUT(S)} \times 0.95$, Measured waveform at CONT pin	90	100	110	kHz	2	
Duty ratio 1	Duty1	$V_{OUT} = V_{OUT(S)} \times 0.95$, Measured waveform at CONT pin	70	75	80	%	2	
Duty ratio 2 (For A, B, D type)	Duty2	Measured waveform at CONT pin at light load	–	50	–	%	1	

Table 15 (2 / 2)

(Ta = 25°C unless otherwise specified)

Item	Symbol	Condition	Min.	Typ.	Max.	Unit	Measurement circuit	
ON / OFF pin input voltage (With shutdown function)	V _{SH}	V _{OUT} = V _{OUT(S)} × 0.95, Measured oscillation at CONT pin	0.75	–	–	V	2	
	V _{SL1}	V _{OUT} = V _{OUT(S)} × 0.95, Judged oscillation stop at CONT pin	–	–	0.3	V	2	
	V _{SL2}		–	–	0.2	V	2	
ON / OFF pin input current (With shutdown function)	I _{SH}	V _{ON/OFF} = 10 V	–0.1	–	0.1	μA	2	
	I _{SL}	V _{ON/OFF} = 0 V	–0.1	–	0.1	μA	2	
Efficiency	EFFI	–	S-8351x30	–	86	–	%	1
			S-8351x50	–	88	–	%	1

External parts

Coil: CDRH6D28-101 (100 μH) of Sumida Corporation

Diode: MA2Z748 (Schottky type) of Matsushita Electric Industrial Co., Ltd.

Capacitor: F93 (16 V, 47 μF tantalum type) of Nichicon Corporation

V_{IN} = V_{OUT(S)} × 0.6 applied, I_{OUT} = V_{OUT(S)} / 250 Ω

With shutdown function : ON / OFF pin is connected to V_{OUT}

For V_{DD} / V_{OUT} separate type : VDD pin is connected to V_{OUT} pin

Remark 1. V_{OUT(S)} specified above is the set output voltage value, and V_{OUT} is the typical value of the actual output voltage.

2. V_{DD} / V_{OUT} separate type

A step-up operation is performed from V_{DD} = 0.8 V. However, 1.8 V ≤ V_{DD} < 10 V is recommended stabilizing the output voltage and oscillation frequency. (V_{DD} ≥ 1.8 V must be applied for products with a set value of less than 1.9 V.)

(2) S-8352 Series

Table 16 (1 / 2)

(Ta = 25°C unless otherwise specified)

Item	Symbol	Condition	Min.	Typ.	Max.	Unit	Measurement circuit	
Output voltage	V_{OUT}	–	$V_{OUT(S)} \times 0.976$	$V_{OUT(S)}$	$V_{OUT(S)} \times 1.024$	V	3	
Input voltage	V_{IN}	–	–	–	10	V	3	
Operation start voltage	V_{ST1}	$I_{OUT} = 1 \text{ mA}$	–	–	0.9	V	3	
Oscillation start voltage	V_{ST2}	No external parts, Voltage applied to V_{OUT}	–	–	0.8	V	4	
Current consumption 1	I_{SS1}	$V_{OUT} = V_{OUT(S)} \times 0.95$	S-8352x15 to 19	–	7.4	12.3	μA	4
			S-8352x20 to 29	–	12.0	20.0	μA	4
			S-8352x30 to 39	–	17.8	29.6	μA	4
			S-8352x40 to 49	–	24.7	41.1	μA	4
			S-8352x50 to 59	–	32.7	54.5	μA	4
			S-8352x60 to 65	–	43.0	71.6	μA	4
Current consumption 2	I_{SS2}	$V_{OUT} = V_{OUT(S)} + 0.5 \text{ V}$	S-8352x15 to 19	–	2.3	3.5	μA	4
			S-8352x20 to 29	–	2.5	3.8	μA	4
			S-8352x30 to 39	–	2.7	4.1	μA	4
			S-8352x40 to 49	–	2.9	4.4	μA	4
			S-8352x50 to 59	–	3.1	4.7	μA	4
			S-8352x60 to 65	–	3.3	5.1	μA	4
Current consumption during shutdown (With shutdown function)	I_{SS3}	$V_{ON/OFF} = 0 \text{ V}$	–	–	0.5	μA	4	
EXT pin output current	I_{EXTH}	$V_{EXT} = V_{OUT} - 0.4 \text{ V}$	S-8352x15 to 19	–3.5	–6.3	–	mA	4
			S-8352x20 to 24	–5.2	–9.4	–	mA	4
			S-8352x25 to 29	–6.8	–12.3	–	mA	4
			S-8352x30 to 39	–8.2	–14.9	–	mA	4
			S-8352x40 to 49	–10.7	–19.4	–	mA	4
			S-8352x50 to 59	–12.5	–22.8	–	mA	4
			S-8352x60 to 65	–13.9	–25.2	–	mA	4
	I_{EXTL}	$V_{EXT} = 0.4 \text{ V}$	S-8352x15 to 19	3.8	6.9	–	mA	4
			S-8352x20 to 24	5.6	10.2	–	mA	4
			S-8352x25 to 29	7.3	13.3	–	mA	4
			S-8352x30 to 39	8.9	16.2	–	mA	4
			S-8352x40 to 49	11.6	21.1	–	mA	4
			S-8352x50 to 59	13.7	25.0	–	mA	4
			S-8352x60 to 65	15.3	27.8	–	mA	4
Line regulation	ΔV_{OUT1}	$V_{IN} = V_{OUT(S)} \times 0.4 \text{ to } \times 0.6$	–	30	60	mV	3	
Load regulation	ΔV_{OUT2}	$I_{OUT} = 10 \mu\text{A to } V_{OUT(S)} / 100 \times 1.25$	–	30	60	mV	3	
Output voltage temperature coefficient	$\frac{\Delta V_{OUT}}{\Delta T_a \bullet V_{OUT}}$	$T_a = -40^\circ\text{C to } +85^\circ\text{C}$	–	± 50	–	ppm / °C	3	
Oscillation frequency	f_{OSC}	$V_{OUT} = V_{OUT(S)} \times 0.95$, Measured waveform at EXT pin	90	100	110	kHz	4	
Duty ratio 1	Duty1	$V_{OUT} = V_{OUT(S)} \times 0.95$, Measured waveform at EXT	70	75	80	%	4	
Duty ratio 2 (For A, B, D type)	Duty2	Measured waveform at EXT pin at light load	–	50	–	%	3	

Table 16 (2 / 2)

(Ta = 25°C unless otherwise specified)

Item	Symbol	Condition	Min.	Typ.	Max.	Unit	Measurement circuit	
ON / OFF pin input voltage (With shutdown function)	V _{SH}	V _{OUT} = V _{OUT(S)} × 0.95, Measured oscillation at EXT	0.75	–	–	V	4	
	V _{SL1}	V _{OUT} = V _{OUT(S)} × 0.95, Judged oscillation stop at EXT pin	At V _{OUT} ≥ 1.5 V	–	–	0.3	V	4
	V _{SL2}		At V _{OUT} < 1.5 V	–	–	0.2	V	4
ON / OFF pin input current (With shutdown function)	I _{SH}	V _{ON/OFF} = 10 V	–0.1	–	0.1	μA	4	
	I _{SL}	V _{ON/OFF} = 0 V	–0.1	–	0.1	μA	4	
Efficiency	EFFI	–	S-8352x30	–	83	–	%	3
			S-8352x50	–	85	–	%	3

External parts

- Coil: CDRH6D28-101 (100 μH) from Sumida Corporation
- Diode: MA2Z748 (Schottky type) from Matsushita Electric Industrial Co., Ltd.
- Capacitor: F93 (16 V, 47 μF tantalum type) from Nichicon Corporation
- Transistor: CPH3210 from Sanyo Electric Co., Ltd.
- Base resistor (Rb): 1 kΩ
- Base capacitor (Cb): 2200 pF (ceramic type)

$V_{IN} = V_{OUT(S)} \times 0.6$ applied, $I_{OUT} = V_{OUT(S)} / 100 \Omega$

With shutdown function : ON / OFF pin is connected to V_{OUT}

For V_{DD} / V_{OUT} separate type : VDD pin is connected to VOUT pin

- Remark 1.** V_{OUT(S)} specified above is the set output voltage value, and V_{OUT} is the typical value of the actual output voltage.
- 2.** V_{DD} / V_{OUT} separate type
 A step-up operation is performed from V_{DD} = 0.8 V. However, 1.8 V ≤ V_{DD} < 10 V is recommended stabilizing the output voltage and oscillation frequency. (V_{DD} ≥ 1.8 V must be applied for products with a set value of less than 1.9 V.)

■ Measurement Circuits

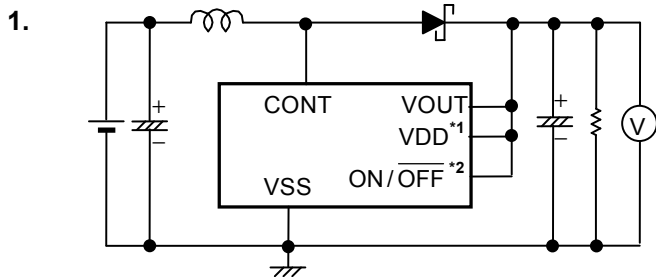

Figure 11

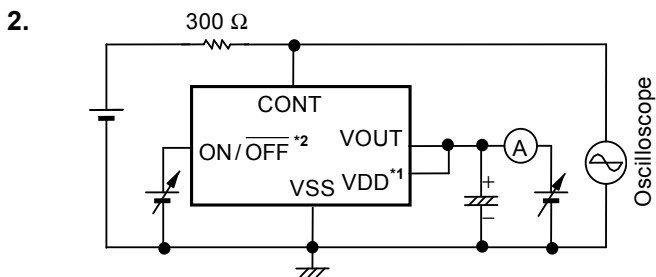

Figure 12

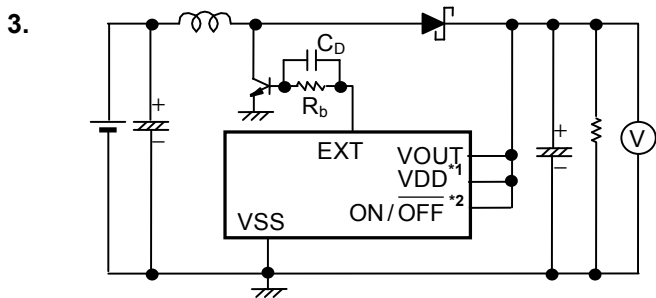

Figure 13

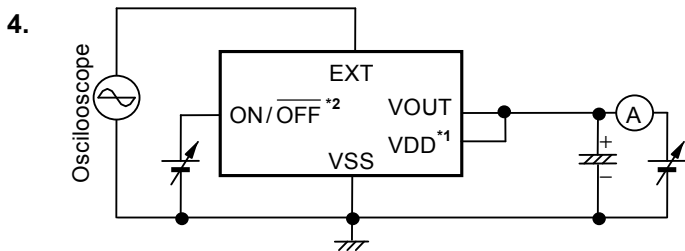

Figure 14

*1. For V_{DD} / V_{OUT} separate type

*2. With shutdown function

■ Operation

1. Step-up DC-DC Converter

The S-8351/8352 Series is a DC-DC converter that uses a pulse frequency modulation method (PFM) and features low current consumption. This series is an especially efficient DC-DC converter at an output current of 100 μA or lower.

In conventional fixed-duty PFM DC-DC converters, although a low duty ratio allows a lower ripple voltage when the current load is light, the efficiency is decreased when the output load current is large. Conversely, a high duty ratio increases the output load current and efficiency, but increases the ripple voltage when the output load current is low.

In the A, B, and D types, the duty ratio is automatically switched 75% when the output load current is high to secure the load drive capability and 50% when the output load current is low to control the load drive capability to decrease pulse skipping. This suppresses a drop in the ripple frequency, enabling control of the increase in the ripple voltage. The C type adopts a 75% fixed-duty PFM method. The ripple voltage increases more than that of the duty switching type with the load is low, but the efficiency is better.

In the A, B, and D types, the duty ratio is not rapidly changed, but rather smoothly switched in the intermediate area between 50% and 75%. Therefore, fluctuation of the ripple voltage caused by duty switching is minimized. **Figures 15, 16** show the ripple voltage characteristics versus the output current.

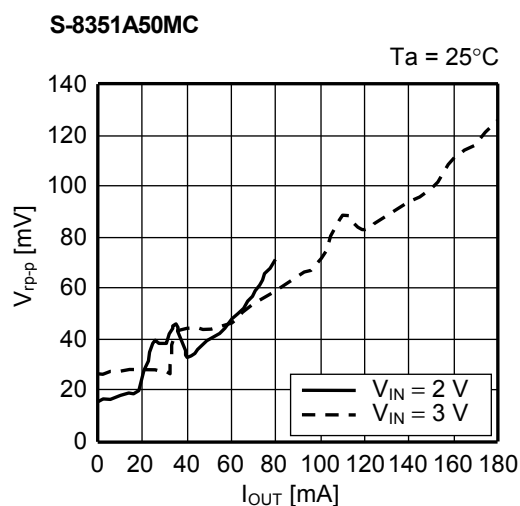
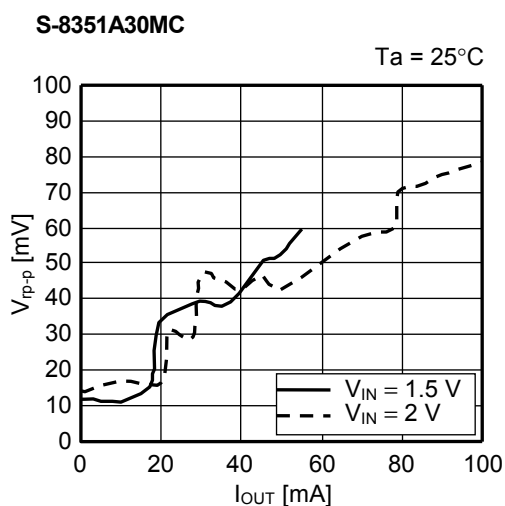

Figure 15 Output Current (I_{OUT}) vs. Ripple Voltage (V_{rip-p}) Characteristics

Figure 16 Output Current (I_{OUT}) vs. Ripple Voltage (V_{rip-p}) Characteristics

These figures show that the ripple voltage decreases as the output load current (I_{OUT}) changes from large to small. The ripple voltage becomes particularly small when I_{OUT} is in the coil current discontinuous region of 20 mA or less.

2. ON/OFF Pin (Shutdown Pin) (A Type)

ON/OFF pin stops or starts step-up operation.

Setting the ON/OFF pin to the “L” level stops operation of all the internal circuits and reduces the current consumption significantly.

DO NOT use the ON/OFF pin in a floating state because it has the structure shown in **Figure 17** and is not pulled up or pulled down internally. DO NOT apply a voltage of between 0.3 V and 0.75 V to the ON/OFF pin because applying such a voltage increases the current consumption. If the shutdown pin is not used, connect it to the VOUT pin.

The ON/OFF pin does not have hysteresis.

Table 17

ON/OFF pin	CR oscillation circuit	Output voltage
“H”	Operation	Fixed
“L”	Stop	$\approx V_{IN}^{*1}$

*1. Voltage obtained by subtracting the voltage drop due to the DC resistance of the inductor and the diode forward voltage from V_{IN} .



Figure 17 ON/OFF Pin Structure

3. Operation

The following are the basic equations [(1) through (7)] of the step-up switching regulator. (Refer to **Figure 18**.)

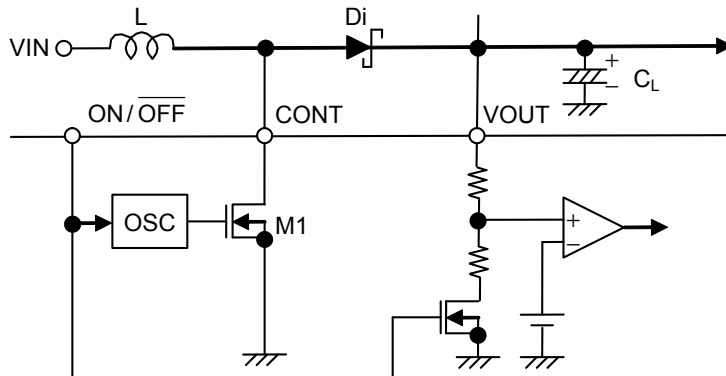

Figure 18 Step-Up Switching Regulator Circuit for Basic Equation

Voltage at CONT pin at the moment M1 is turned ON (V_A) *1 :

$$V_A = V_S \text{ *2} \dots\dots\dots (1)$$

*1. Current flowing through L (I_L) is zero.

*2. Non-saturated voltage of M1.

The change in I_L over time :

$$\frac{dI_L}{dt} = \frac{V_L}{L} = \frac{V_{IN} - V_S}{L} \dots\dots\dots (2)$$

Integration of equation (2) (I_L) :

$$I_L = \left(\frac{V_{IN} - V_S}{L} \right) \cdot t \dots\dots\dots (3)$$

I_L flows while M1 is ON (t_{ON}). The time of t_{ON} is determined by the oscillation frequency of OSC.

The peak current (I_{PK}) after t_{ON} :

$$I_{PK} = \left(\frac{V_{IN} - V_S}{L} \right) \cdot t_{ON} \dots\dots\dots (4)$$

The energy stored in L is represented by $1/2 \cdot L \cdot (I_{PK})^2$.

When M1 is turned OFF (t_{OFF}), the energy stored in L is emitted through a diode to the output capacitor.

Then, the reverse voltage (V_L) is generated :

$$V_L = (V_{OUT} + V_D \text{ *1}) - V_{IN} \dots\dots\dots (5)$$

*1. Diode forward voltage

The voltage at CONT pin rises only by $V_{OUT} + V_D$.

The change in the current (I_L) flowing through the diode into V_{OUT} during t_{OFF} :

$$\frac{dI_L}{dt} = \frac{V_L}{L} = \frac{V_{OUT} + V_D - V_{IN}}{L} \dots\dots\dots (6)$$

Integration of the equation (6) is as follows :

$$I_L = I_{PK} - \left(\frac{V_{OUT} + V_D - V_{IN}}{L} \right) \cdot t \dots\dots\dots (7)$$

During t_{ON} , the energy is stored in L and is not transmitted to V_{OUT} . When receiving the output current (I_{OUT}) from V_{OUT} , the energy of the capacitor (C_L) is consumed. As a result, the pin voltage of C_L is reduced, and goes to the lowest level after M1 is turned ON (t_{ON}). When M1 is turned OFF, the energy stored in L is transmitted through the diode to C_L , and the voltage of C_L rises rapidly. V_{OUT} is a time function, and therefore indicates the maximum value (ripple voltage (V_{P-P})) when the current flowing through into V_{OUT} and load current (I_{OUT}) match.

Next, the ripple voltage is determined as follows.

I_{OUT} vs. t_1 (time) from when M1 is turned OFF (after t_{ON}) to when V_{OUT} reaches the maximum level :

$$I_{OUT} = I_{PK} - \left(\frac{V_{OUT} + V_D - V_{IN}}{L} \right) \cdot t_1 \dots\dots\dots (8)$$

$$\therefore t_1 = (I_{PK} - I_{OUT}) \cdot \left(\frac{L}{V_{OUT} + V_D - V_{IN}} \right) \dots\dots\dots (9)$$

When M1 is turned OFF (t_{OFF}), $I_L = 0$ (when the energy of the inductor is completely transmitted). Based on equation (7) :

$$\left(\frac{L}{V_{OUT} + V_D - V_{IN}} \right) = \frac{t_{OFF}}{I_{PK}} \dots\dots\dots (10)$$

When substituting equation (10) for equation (9) :

$$t_1 = t_{OFF} - \left(\frac{I_{OUT}}{I_{PK}} \right) \cdot t_{OFF} \dots\dots\dots (11)$$

Electric charge ΔQ_1 which is charged in C_L during t_1 :

$$\Delta Q_1 = \int_0^{t_1} I_L dt = I_{PK} \cdot \int_0^{t_1} dt - \frac{V_{OUT} + V_D - V_{IN}}{L} \cdot \int_0^{t_1} t dt = I_{PK} \cdot t_1 - \frac{V_{OUT} + V_D - V_{IN}}{L} \cdot \frac{1}{2} t_1^2 \dots\dots\dots (12)$$

When substituting equation (12) for equation (9) :

$$\Delta Q_1 = I_{PK} - \frac{1}{2} (I_{PK} - I_{OUT}) \cdot t_1 = \frac{I_{PK} + I_{OUT}}{2} \cdot t_1 \dots\dots\dots (13)$$

A rise in voltage (V_{P-P}) due to ΔQ_1 :

$$V_{P-P} = \frac{\Delta Q_1}{C_L} = \frac{1}{C_L} \cdot \left(\frac{I_{PK} + I_{OUT}}{2} \right) \cdot t_1 \dots\dots\dots (14)$$

When taking into consideration I_{OUT} to be consumed during t_1 and the Equivalent Series Resistance (R_{ESR}) of C_L :

$$V_{P-P} = \frac{\Delta Q_1}{C_L} = \frac{1}{C_L} \cdot \left(\frac{I_{PK} + I_{OUT}}{2} \right) \cdot t_1 + \left(\frac{I_{PK} + I_{OUT}}{2} \right) \cdot R_{ESR} - \frac{I_{OUT} \cdot t_1}{C_L} \dots\dots\dots (15)$$

When substituting equation (11) for equation (15) :

$$V_{P-P} = \frac{(I_{PK} - I_{OUT})^2}{2I_{PK}} \cdot \frac{t_{OFF}}{C_L} + \left(\frac{I_{PK} + I_{OUT}}{2} \right) \cdot R_{ESR} \dots\dots\dots (16)$$

Therefore to reduce the ripple voltage, it is important that the capacitor connected to the output pin has a large capacity and a small R_{ESR} .

■ External Parts Selection

1. Inductor

To minimize the loss due to inductor direct current resistance, select an inductor with the smallest possible direct current resistance (less than 1 Ω). Set the inductance value (L value) to around 22 μH to 1 mH.

To make the average value of the output voltage (V_{OUT}) constant, it is necessary to supply the energy corresponding to the output current (I_{OUT}) from the inductor. The amount of charge required for I_{OUT} is $I_{OUT} \times (t_{ON} + t_{OFF})$. Because the inductor can supply energy only during t_{OFF} , the charge is obtained by integrating equation (7) in the “3.

Operation” in the “■ Operation” with $0 \rightarrow t_{OFF}$, namely, $\frac{I_{PK}}{2} \cdot t_{OFF}$. Thus,

$$\frac{I_{PK}}{2} \cdot t_{OFF} = I_{OUT} \times (t_{ON} + t_{OFF}) \dots\dots\dots (17)$$

$$\therefore I_{PK} = 2 \cdot \frac{t_{ON} + t_{OFF}}{t_{OFF}} \cdot I_{OUT} \dots\dots\dots (18)$$

When the oscillation duty ratio of OSC is 75%, $I_{PK} = 8 \cdot I_{OUT}$. Therefore, an I_{PK} current which is eight times I_{OUT} flows into transistor (M1).

The S-8351 Series includes a switching current controller which monitors the current flowing into the CONT pin by the voltage (CONT control voltage) and controls the current. This controller prevents destruction of the IC due to excess current.

If an inductor with a large L value is selected, both I_{PK} and I_{OUT} decrease. Since the energy stored in the inductor is equal to $\frac{1}{2} L \cdot (I_{PK})^2$, the energy decreases because I_{PK} decreases in steps of squares offsetting the increase of L

value. As a result, stepping up at a low voltage becomes difficult and the minimum operating input voltage becomes high. However, the direct current resistance loss of L value and the M1 transistor decreases by the amount I_{PK} decreased, and the inductance efficiency improves.

On the other hand, if an inductor with a smaller L value is selected, both I_{PK} and I_{OUT} increase. Accordingly, the minimum operating input voltage becomes low but the inductance efficiency deteriorates.

Caution An excessively large I_{PK} may cause magnetic saturation for some core materials, leading to the destruction of the IC. Use a core with material that satisfies $I_{sat}^{*1} > I_{PK}$

*1. Level of current that causes magnetic saturation.

2. Diode

Use an external diode that meets the following requirements :

- Low forward voltage : $V_F < 0.3 \text{ V}$
- High switching speed : 500 ns max.
- Reverse voltage : $V_{OUT} + V_F$ or more
- Current rate : I_{PK} or more

3. Capacitor (C_{IN} , C_L)

A capacitor on the input side (C_{IN}) improves the efficiency by reducing the power impedance and stabilizing the input current. Select a C_{IN} value according to the impedance of the power supply used.

A capacitor on the output side (C_L) is used for smoothing the output voltage. For step-up types, the output voltage flows intermittently to the load current, so step-up types need a larger capacitance than step-down types. Therefore, select an appropriate capacitor in accordance with the ripple voltage, which increases in case of a higher output voltage or a higher load current. The capacitor value should be 10 μ F or more.

A capacitor at the output side (C_L) is used for smoothing the ripple voltage. Select an appropriate capacitor with a small equivalent series resistance (R_{ESR}) and a large capacitance. The capacitor value should be 10 μ F or more. A tantalum electrolytic capacitor and an organic semiconductor capacitor are especially recommended because of their superior low-temperature and leakage current characteristics.

4. External Transistor (S-8352 Series)

For the S-8352 Series, connecting an external transistor increases the output current. An enhancement (N-channel) MOS FET type or a bipolar (NPN) type can be used as the external transistor.

4.1 Enhancement (N-channel) MOS FET Type

Figure 19 is a circuit example using a MOS FET transistor (N-channel).

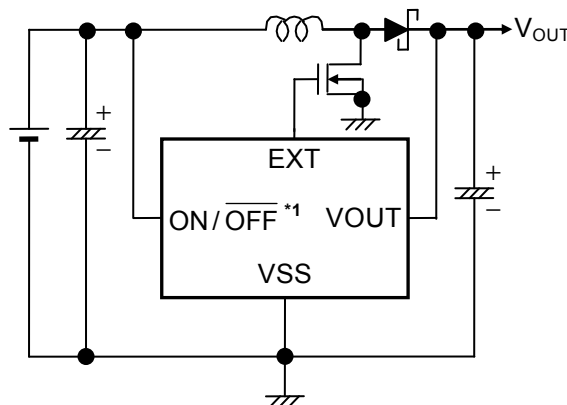

*1. For A type.

Figure 19 Circuit Example Using MOS FET (N-channel) Type

An N-channel power MOS FET should be used for the MOS FET. In particular, the EXT pin can drive a MOS FET with a gate capacitance of around 1000 pF. Because the gate voltage and current of the external power MOS FET are supplied from the stepped-up output voltage (V_{OUT}), the MOS FET is driven more effectively.

A large current may flow during startup, depending on the MOS FET selection. The S-8352 Series does not feature overcurrent protection for the external MOS FET, so perform sufficient evaluation using the actual devices. Also recommend to use a MOS FET with an input capacitance of 700 pF or less.

Since the ON-resistance of the MOS FET might depend on the difference between the output voltage (V_{OUT}) and the threshold voltage of the MOS FET, and affect the output current as well as the efficiency, the threshold voltage should be low. When the output voltage is as low as 2.0 V, like in the S-8352A20, the circuit operates only when the MOS FET has a threshold voltage lower than the output voltage.

4.2 Bipolar (NPN) Type

A circuit example using the CPH3210 ($h_{FE} = 200$ to 560) from Sanyo Electric Co., Ltd. as a bipolar transistor (NPN) is shown in **Figure 24 to 26** in the “**Standard Circuits**”. The h_{FE} value and R_b value of the bipolar transistor determine the driving capacity to increase the output current using a bipolar transistor. A peripheral circuit example of the transistor is shown in **Figure 20**.

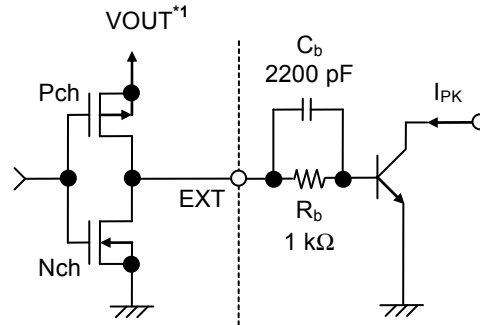

*1. V_{DD} for D type.

Figure 20 External Transistor Peripheral Circuit

The recommended R_b value is around $1\text{ k}\Omega$. Actually, calculate the necessary base current (I_b) from the bipolar transistor (h_{FE}) using $I_b = \frac{I_{PK}}{h_{FE}}$, and select the smaller R_b value than $R_b = \frac{V_{OUT} - 0.7}{I_b} - \frac{0.4}{|I_{EXTH}|}$ *1.

A small R_b value can increase the output current, but the efficiency decreases. Since a current may flow on the pulse and the voltage may drop due to wiring resistance or other factors in the actual circuit, therefore the optimum R_b value should be determined by experiment.

Connecting the speed-up capacitor (C_b) in parallel with the R_b resistance as shown in **Figure 20**, decreases switching loss and improves the efficiency.

The C_b value is calculated according to $C_b \leq \frac{1}{2\pi \cdot R_b \cdot f_{osc} \cdot 0.7}$.

Select a C_b value after performing sufficient evaluation since the optimum C_b value differs depending upon the characteristics of the bipolar transistor.

*1. For D type, $R_b = \frac{V_{DD} - 0.7}{I_b} - \frac{0.4}{|I_{EXTH}|}$.

5. V_{DD} / V_{OUT} Separate Type (For S-8351/8352 Series D Type)

The D type provides separate internal circuit power supply (V_{DD} pin) and output voltage setting pin (V_{OUT} pin) in the IC, making it ideal for the following applications.

- (1) Changing the output voltage value using an external resistor
- (2) Setting a high output voltage value, such as +15 V

- Cautions**
1. This IC starts a step-up operation at $V_{DD} = 0.8$ V, but set $1.8 \leq V_{DD} \leq 10$ V to stabilize the output voltage and frequency of the oscillator. (Input a voltage of 1.8 V or more at the V_{DD} pin for all products with a setting less than 1.9 V.) An input voltage of 1.8 V or more at the V_{DD} pin allows connection of the V_{DD} pin to either the input voltage V_{IN} pin or output V_{OUT} pin.
 2. Choose external resistors R_A and R_B so as to not affect the output voltage, considering that there is impedance between the V_{OUT} pin and V_{SS} pin in the IC chip. The internal resistance between the V_{OUT} pin and V_{SS} pin is as follows :
 - (1) S-835xx18 : 2.1 M Ω to 14.8 M Ω
 - (2) S-835xx20 : 1.4 M Ω to 14.8 M Ω
 - (3) S-835xx30 : 1.4 M Ω to 14.2 M Ω
 - (4) S-835xx50 : 1.4 M Ω to 12.1 M Ω
 3. Attach a capacitor (C_C) in parallel to the R_A resistance when an unstable event such as oscillation of the output voltage occurs. Calculate C_C using the following equation :

$$C_C [F] = \frac{1}{2 \cdot \pi \cdot R_A \cdot 20 \text{ kHz}}$$

■ **Standard Circuits**

1. **S-8351 Series**

(1) **A type**

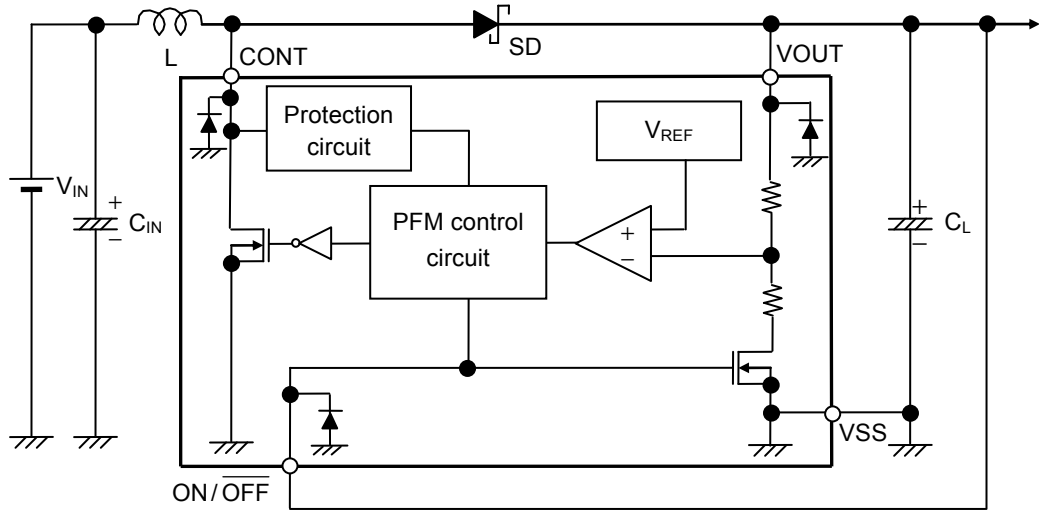

Figure 21

(2) **B and C types**

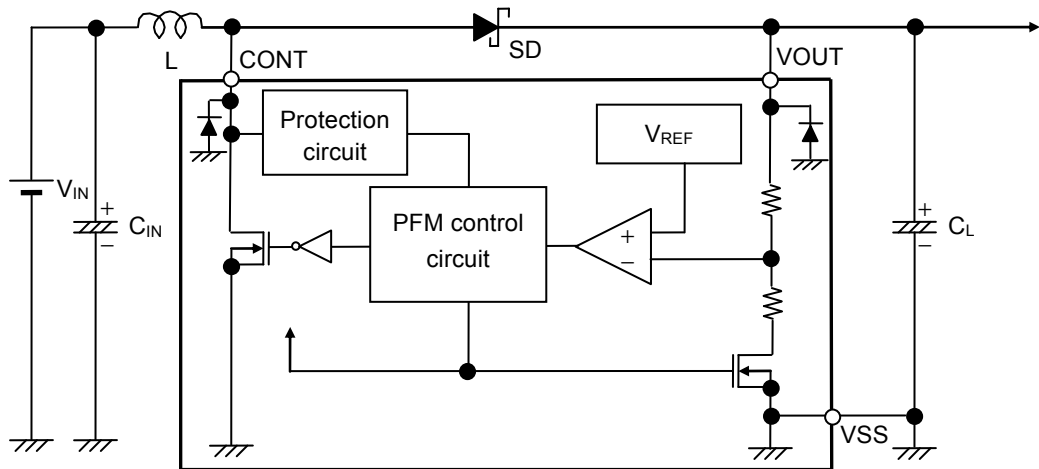

Figure 22

(3) D type

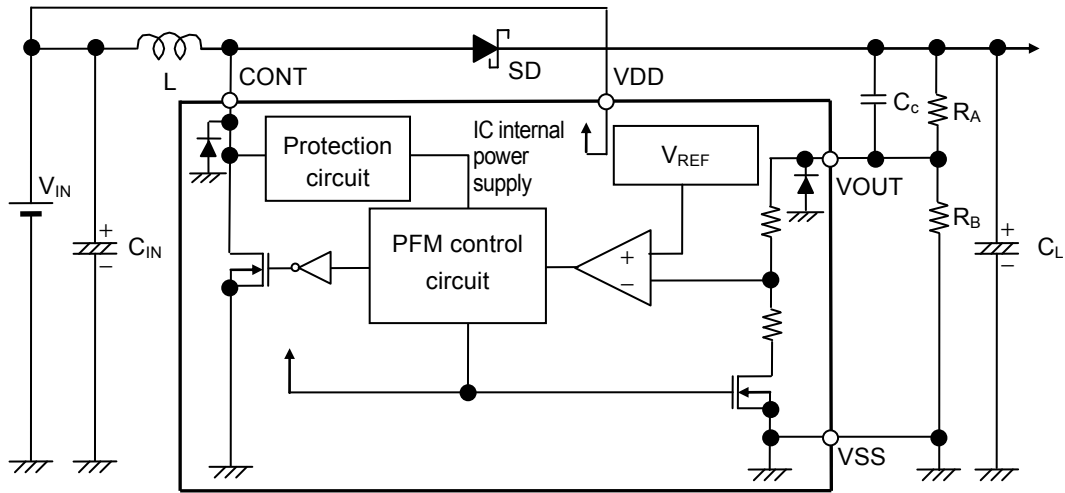

Figure 23

Caution The above connection diagrams and constants will not guarantee successful operation. Perform thorough evaluation using the actual application to set the constants.

2. S-8352 Series

(1) A type

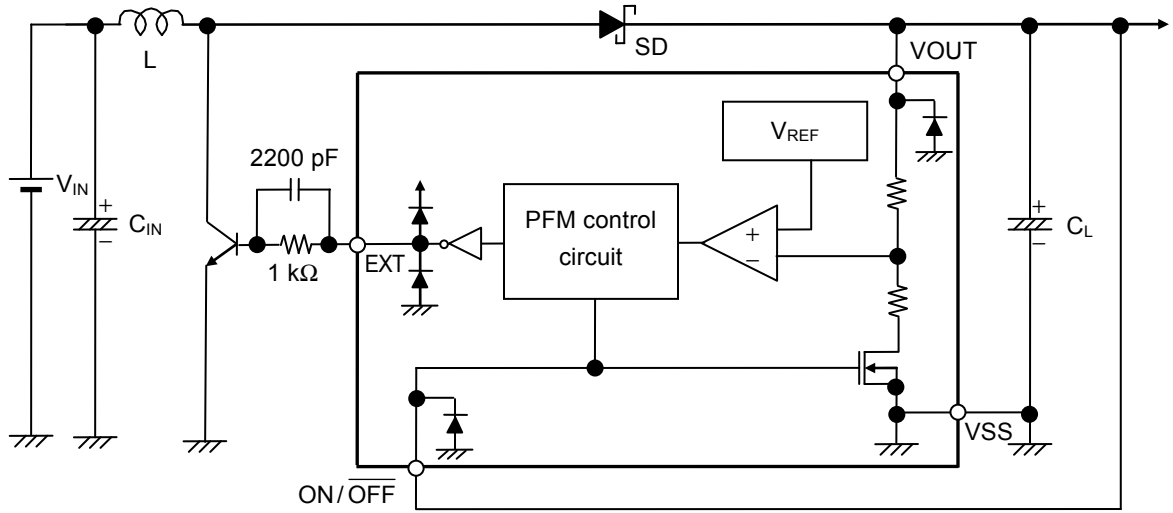

Figure 24

(2) B and C types

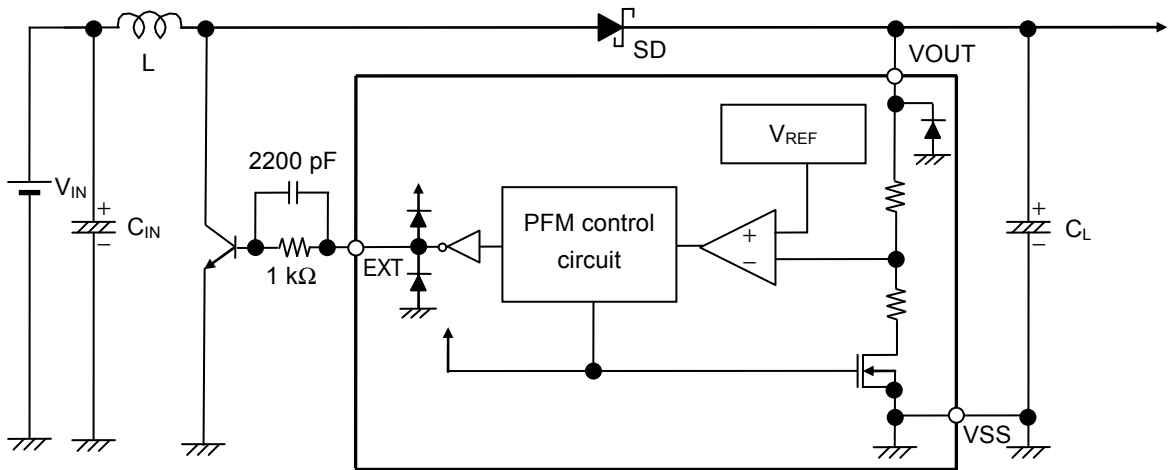

Figure 25

(3) D type

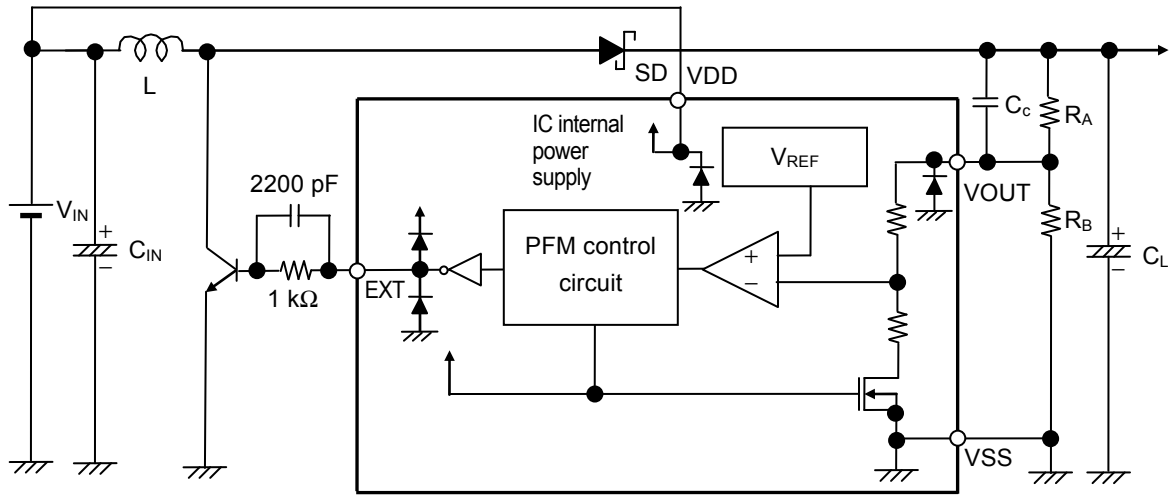

Figure 26

Caution The above connection diagrams and constants will not guarantee successful operation. Perform thorough evaluation using the actual application to set the constants.

■ Precautions

- Mount the external capacitors, the diode, and the coil as close as possible to the IC.
- Characteristics ripple voltage and spike noise occur in IC containing switching regulators. Moreover, rush current flows at the time of a power supply injection. Because they largely depend on the coil and the capacitor and impedance used, fully check them using an actually mounted model.
- Make sure that the dissipation of the switching transistor (especially at a high temperature) does not exceed the allowable power dissipation of the package.
- The performance of this IC varies depending on the design of the PCB patterns, peripheral circuits and external parts. Thoroughly test all settings with your device. Also, try to use the recommended external parts. If not, contact an ABLIC Inc. sales person.
- When the impedance of the power supply is high, the shutdown pin is switched from “L” to “H”, or V_{IN} is connected to the power supply, note that the power supply voltage drops temporarily because a rush current flows into the power supply.
- Do not apply an electrostatic discharge to this IC that exceeds the performance ratings of the built-in electrostatic protection IC.
- ABLIC Inc. claims no responsibility for any and all disputes arising out of or in connection with any infringement of the products including this IC upon patents owned by third party.

■ Characteristics (Typical Data)

1. Input voltage (V_{IN}) vs. Power Supply Input Current at No Load (I_{IN})

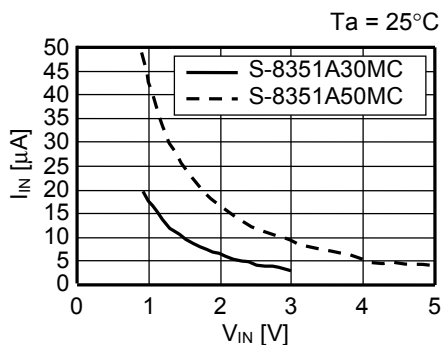

2. Output Voltage (V_{OUT}) vs. Current Consumption 1 (I_{SS1})

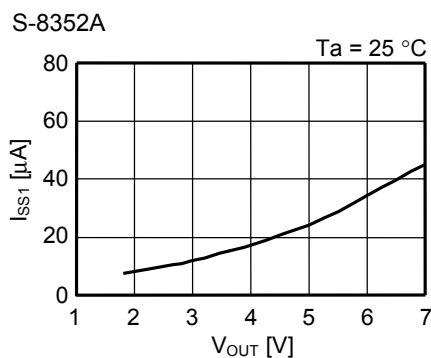
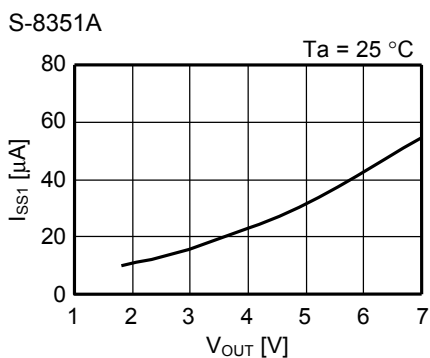

3. Temperature (T_a) vs. Current Consumption 1 (I_{SS1})

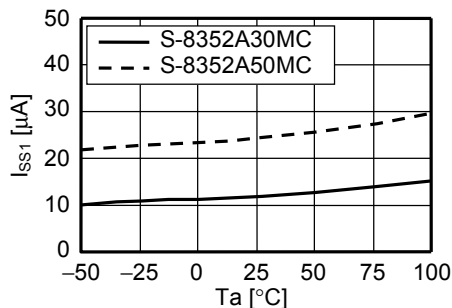
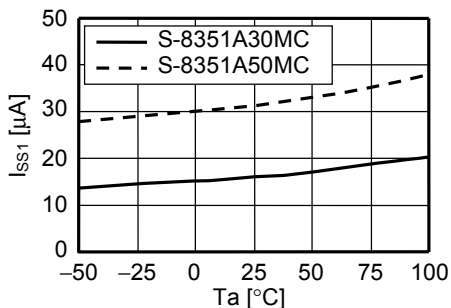

4. Output Voltage (V_{OUT}) vs. Current Consumption 2 (I_{SS2}) 5. Temperature (T_a) vs. Current Consumption 2 (I_{SS2})

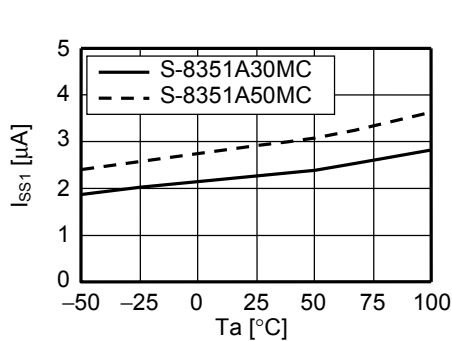
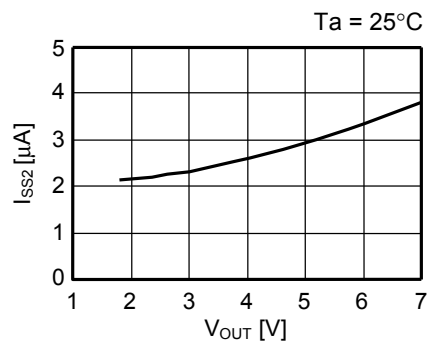

6. Temperature (Ta) vs. Oscillation Frequency (f_{osc})

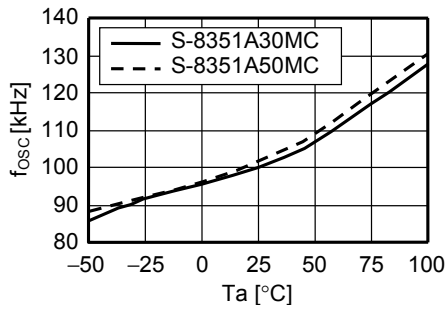

7. Temperature (Ta) vs. Duty Ratio 1 (Duty1)

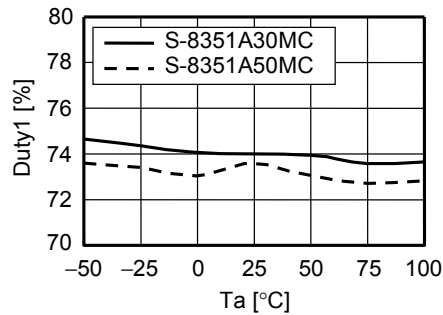

8. Temperature (Ta) vs. Duty Ratio 2 (Duty2)

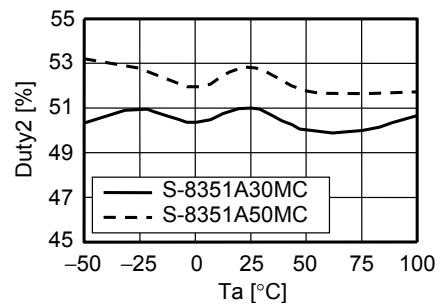

9. Output Voltage (V_{OUT}) vs. Switching Current (I_{sw})

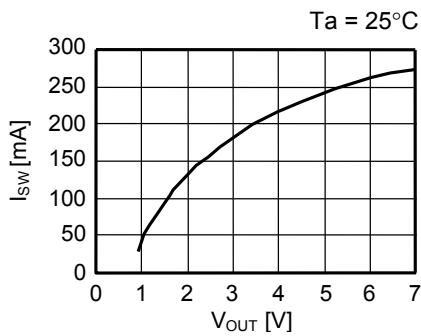

10. Temperature (Ta) vs. Switching Current (I_{sw})

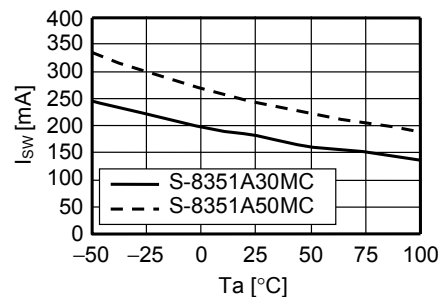

11. Output Voltage (V_{OUT}) vs. EXT Pin Output Current "H" (I_{EXTH})

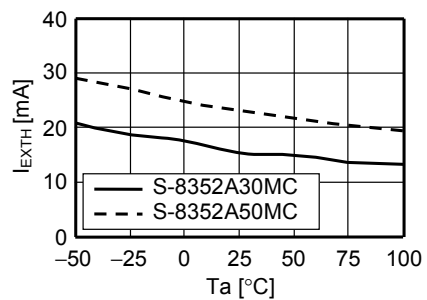
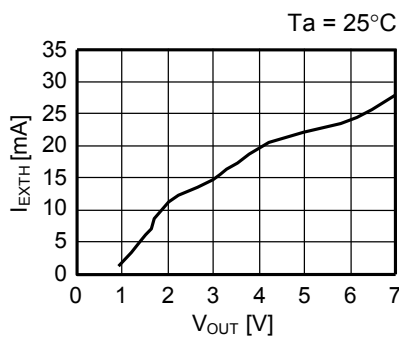

13. Output Voltage (V_{OUT}) vs. EXT Pin Output Current "L" (I_{EXTL}) 14. Temperature (T_a) vs. EXT Pin Output Current "L" (I_{EXTL})

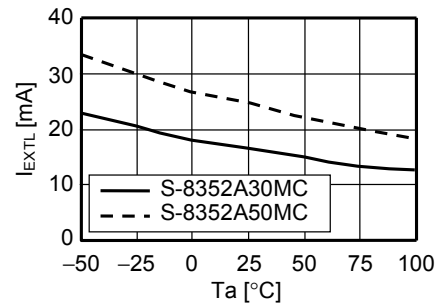
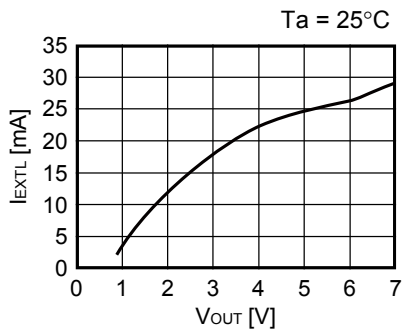

15. Temperature (T_a) vs. Operation Start Voltage (V_{ST1}) 16. Temperature (T_a) vs. Retention Voltage (V_{HLD})

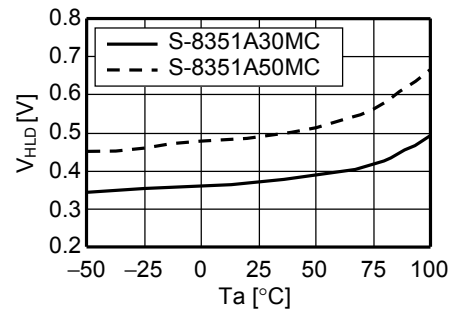
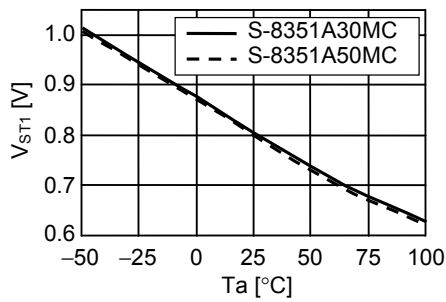

17. Transient Response Characteristics

The conditions for external parts are the same as those specified in the electrical characteristics.

(1) Power-on ($T_a = 25^\circ\text{C}$, $R_L = 250 \Omega$)

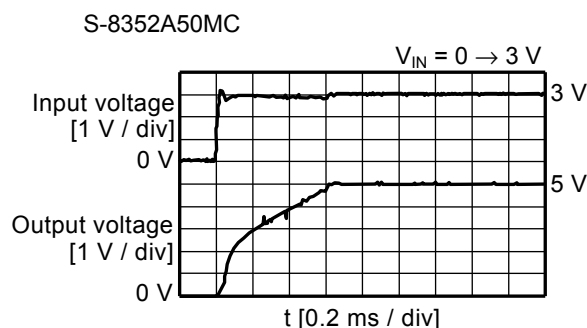
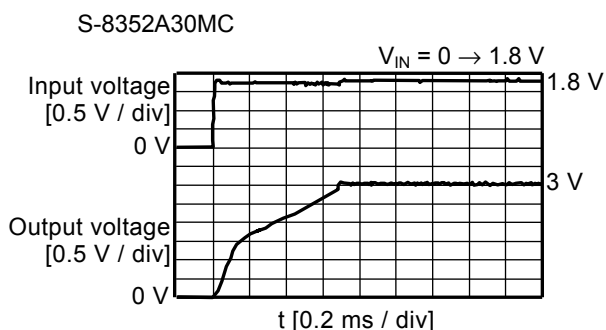
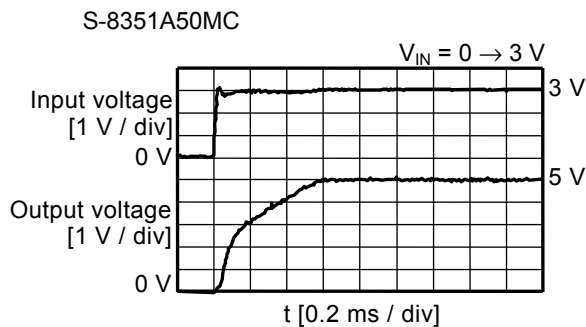
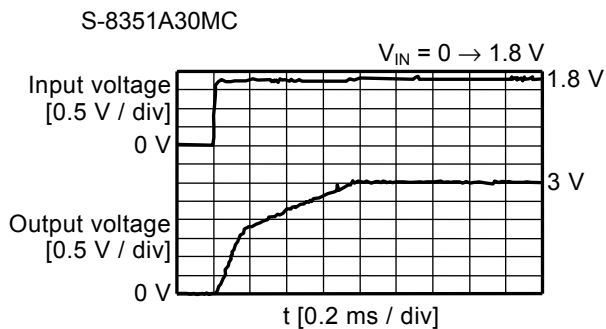

(2) Power Supply Voltage Fluctuation ($T_a = 25^\circ\text{C}$, $R_L = 250 \Omega$)

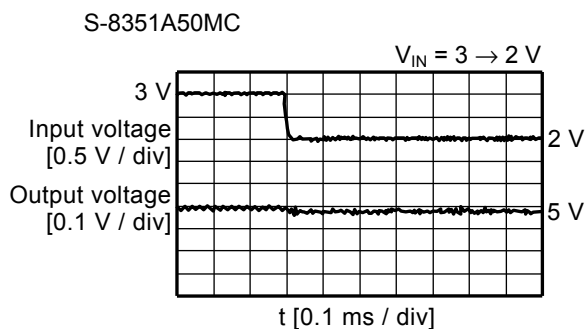
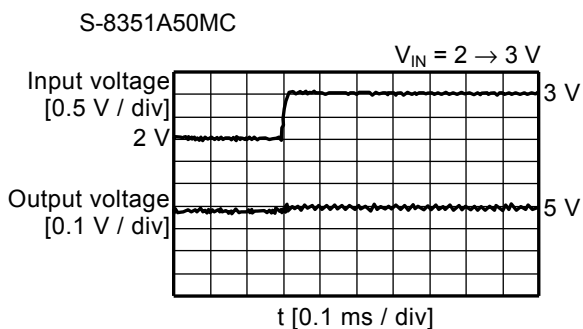
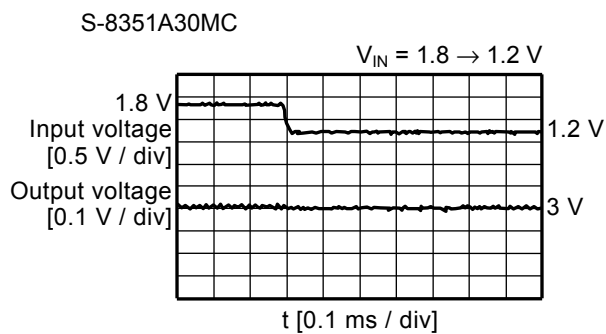
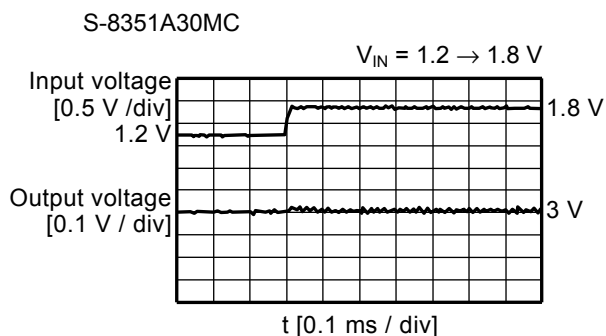

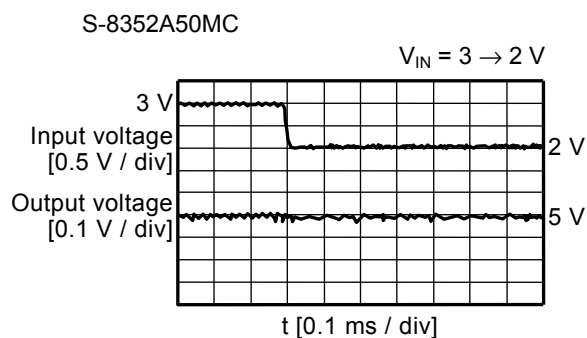
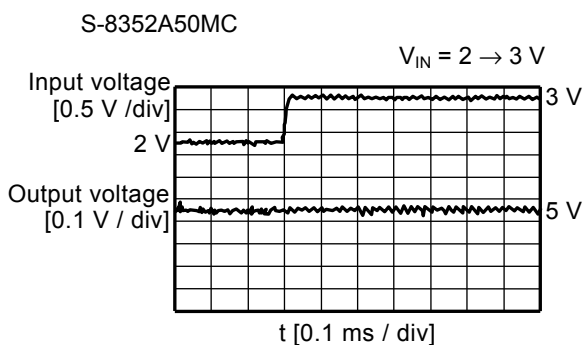
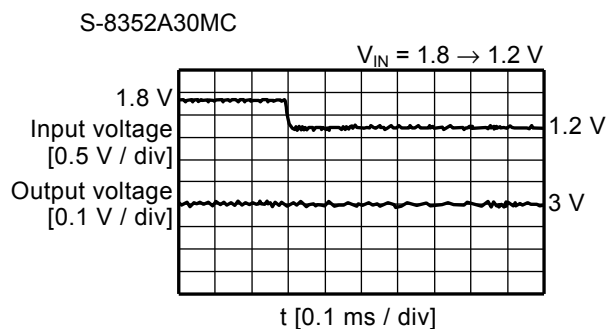
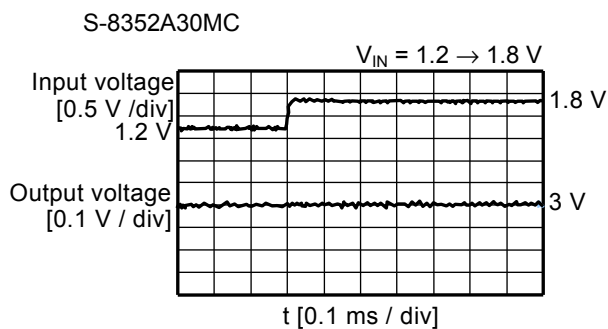

(3) Load Current Fluctuation ($T_a = 25^\circ\text{C}$)

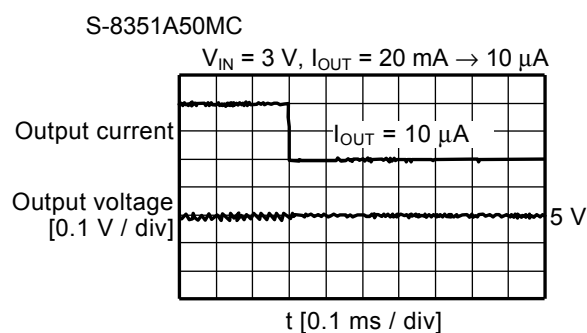
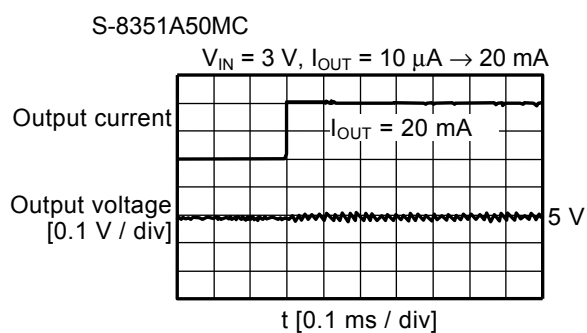
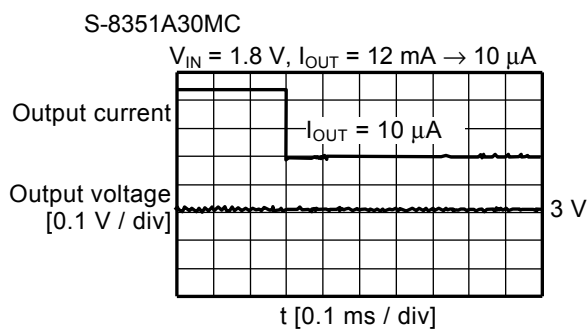
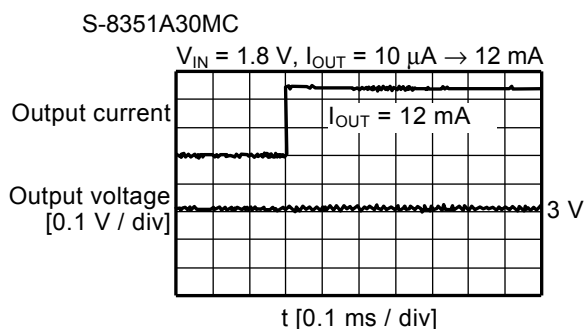

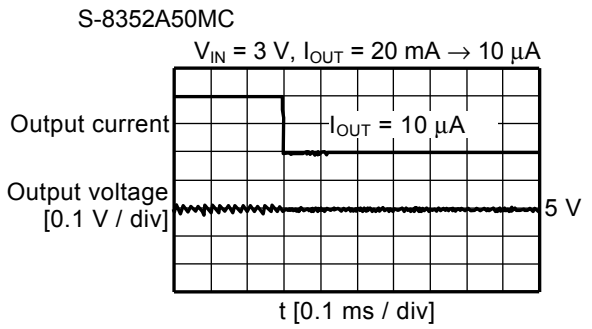
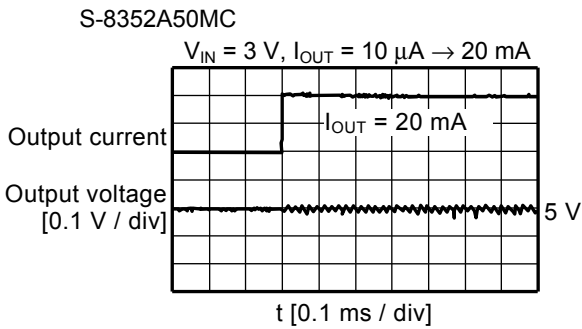
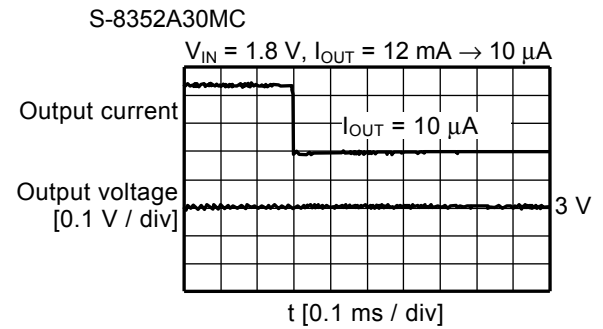
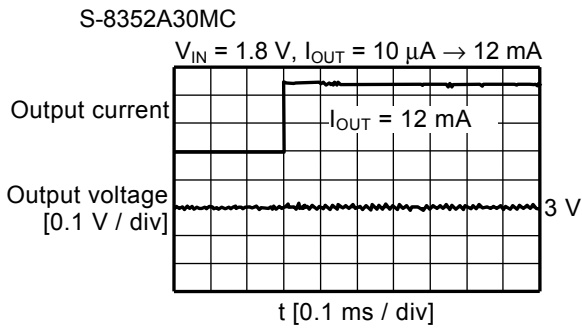

(4) ON/OFF Pin Response ($T_a = 25^\circ\text{C}, R_L = 250\ \Omega$)

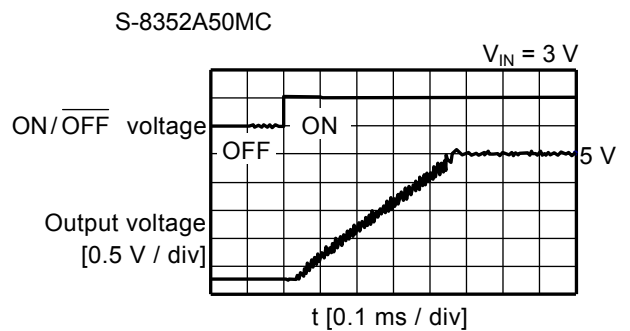
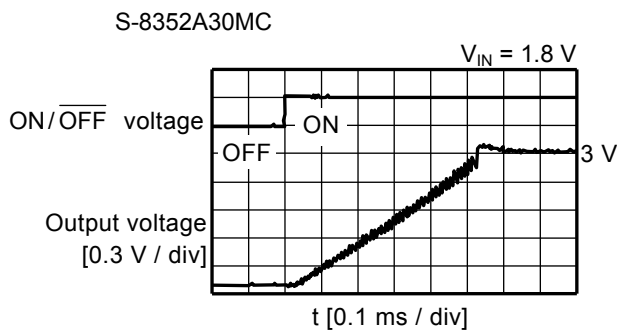
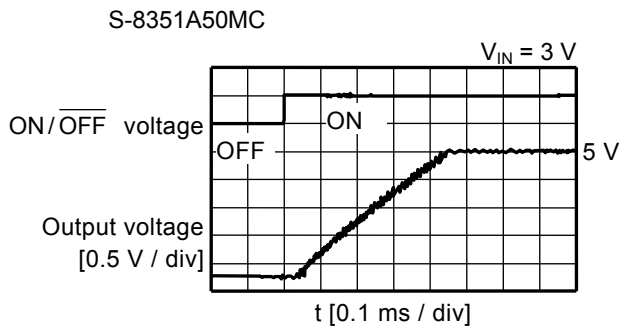
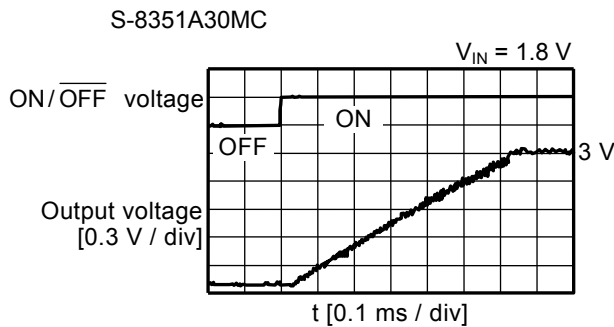

■ Reference Data

Use this reference data to choose the external parts. This reference data makes it possible to choose the recommended external part based on the application and characteristics data.

1. External Parts for Reference Data

Table 18

Condition	Product Name	Output Voltage V	Power MOS FET	Coil
1	S-8351A30MC	3.0	Built-in	CDRH6D28-470
2	S-8351A30MC	3.0	Built-in	CDRH6D28-101
3	S-8351A30MC	3.0	Built-in	CXLP120-101
4	S-8351A50MC	5.0	Built-in	CDRH6D28-101
5	S-8351A50MC	5.0	Built-in	CDRH125-221
6	S-8351A50MC	5.0	Built-in	CXLP120-470
7	S-8352A30MC	3.0	External	CDRH6D28-220
8	S-8352A30MC	3.0	External	CDRH6D28-101
9	S-8352A30MC	3.0	External	CXLP120-470
10	S-8352A50MC	5.0	External	CDRH6D28-220
11	S-8352A50MC	5.0	External	CDRH6D28-101
12	S-8352A50MC	5.0	External	CXLP120-101

The properties of the external parts are shown below.

Table 19 Evaluation coil

Part	Product Name	Manufacturer	Characteristics
Coil	CDRH6D28-220	Sumida Corporation	22 μH, DCR *1 = 0.128 Ω, I _{MAX} *2 = 1200 mA
	CDRH6D28-470	Sumida Corporation	47 μH, DCR *1 = 0.238 Ω, I _{MAX} *2 = 800 mA
	CDRH6D28-101	Sumida Corporation	100 μH, DCR *1 = 0.535 Ω, I _{MAX} *2 = 540 mA
	CDRH125-221	Sumida Corporation	220 μH, DCR *1 = 0.4 Ω, I _{MAX} *2 = 800 mA
	CXLP120-470	Sumitomo Special Metals Co., Ltd	47 μH, DCR *1 = 0.95 Ω, I _{MAX} *2 = 450 mA
	CXLP120-101	Sumitomo Special Metals Co., Ltd	100 μH, DCR *1 = 2.5 Ω, I _{MAX} *2 = 200 mA

*1. Direct current resistance

*2. Maximum allowable current

Table 20 Properties of External Parts

Part	Product Name	Manufacturer	Characteristics
Diode	MA2Z748	Matsushita Electronic Components Co., Ltd.	V _F *1 = 0.4V, I _F *2 = 0.3A (Schottky type)
Capacitor (Output capacitance)	F93	Nichicon Corporation	16V, 47μF (Tantalum type)
Transistor (NPN)	CPH3210	Sanyo Electric Co.,Ltd.	V _{CBO} *3 = 40V, V _{CEO} *4 = 30V hFE *5 = 200 min. (V _{CE} = 2V, I _C = 500mA) f _T *6 = 290 MHz typ. (V _{CE} = 10V, I _C = 500mA)

*1. Forward voltage, *2. Forward current, *3. Collector-to-base voltage, *4. Collector-to-emitter voltage, *5. DC current gain, *6. Gain-bandwidth product

Caution The above values shown in the characteristics column of Table 19 and 20 are based on the materials provided by each manufacture. However, consider the characteristics of the original materials when using the above products.

2. Step-up Characteristics (Ta = 25°C)

The data of the step-up characteristics ((a) Input voltage (V_{IN}) vs. Output voltage (V_{OUT}) characteristics (Input voltage stepped up), (b) Input voltage (V_{IN}) vs. Output voltage (V_{OUT}) characteristics (Input voltage stepped down), (c) Output current (I_{OUT}) vs. Output voltage (V_{OUT}) characteristics, (d) Output current (I_{OUT}) vs. Efficiency (η) characteristics under conditions of 1 to 12 in **Table 18** is shown below.

Condition 1 S-8351A30MC

(a) Input voltage (V_{IN}) vs. Output voltage (V_{OUT})
 (Input voltage raising)



(b) Input voltage (V_{IN}) vs. Output voltage (V_{OUT})
 (Input voltage falling)



(c) Output current (I_{OUT}) vs. Output voltage (V_{OUT})

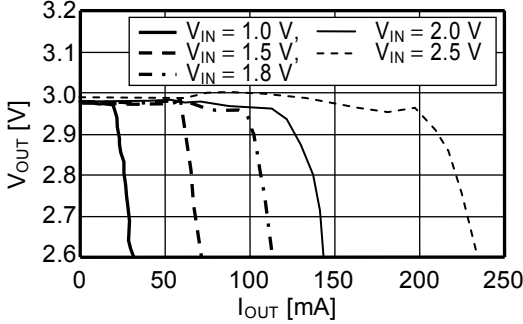

(d) Output current (I_{OUT}) vs. Efficiency (η)

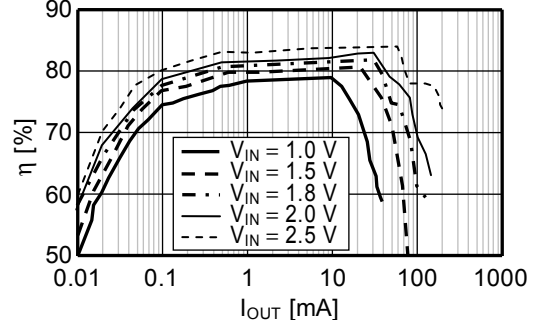

Condition 2 S-8351A30MC

(a) Input voltage (V_{IN}) vs. Output voltage (V_{OUT})
 (Input voltage raising)

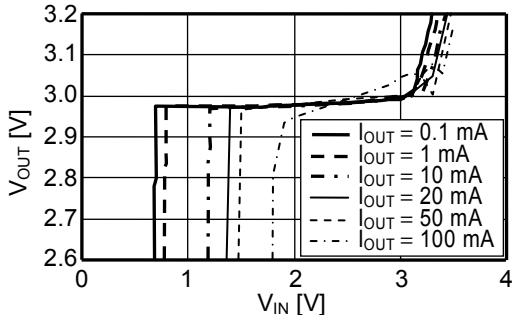

(b) Input voltage (V_{IN}) vs. Output voltage (V_{OUT})
 (Input voltage falling)

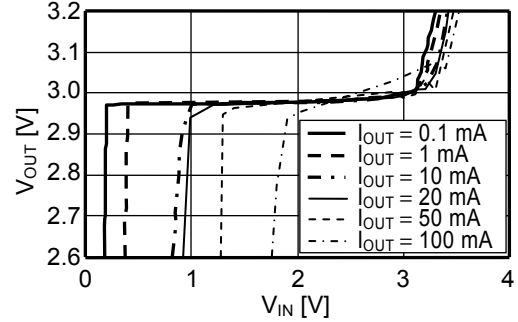

(c) Output current (I_{OUT}) vs. Output voltage (V_{OUT})

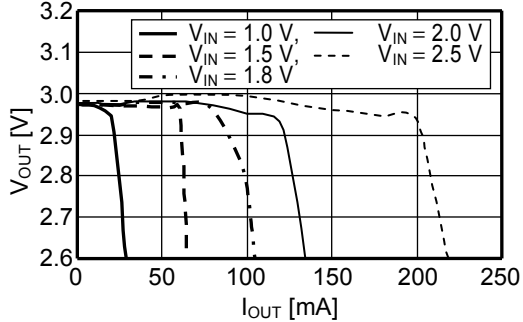

(d) Output current (I_{OUT}) vs. Efficiency (η)

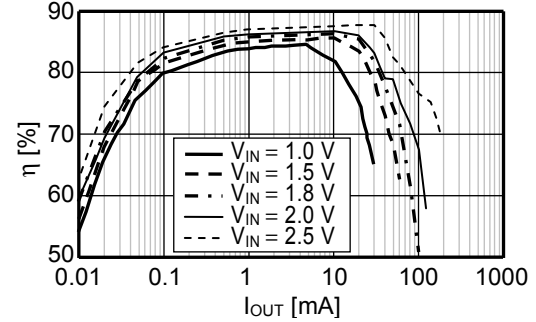

Condition 3 S-8351A30MC

(a) Input voltage (V_{IN}) vs. Output voltage (V_{OUT})
(Input voltage raising)

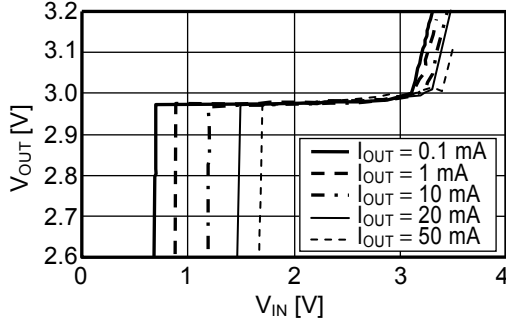

(b) Input voltage (V_{IN}) vs. Output voltage (V_{OUT})
(Input voltage falling)

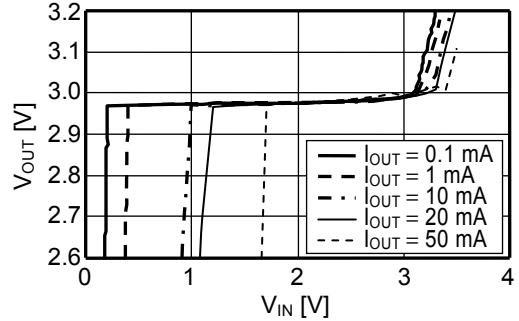

(c) Output current (I_{OUT}) vs. Output voltage (V_{OUT})

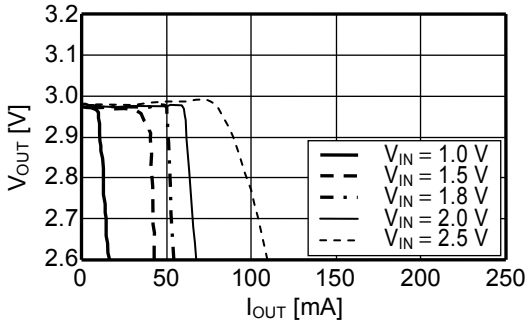

(d) Output current (I_{OUT}) vs. Efficiency (η)

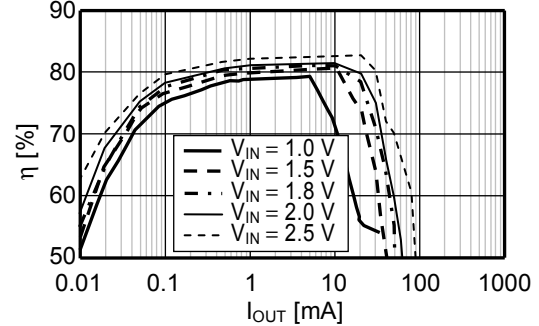

Condition 4 S-8351A50MC

(a) Input voltage (V_{IN}) vs. Output voltage (V_{OUT})
(Input voltage raising)

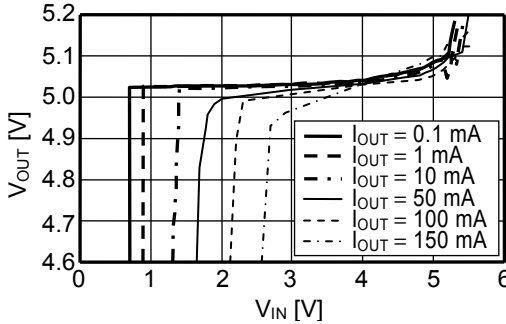

(b) Input voltage (V_{IN}) vs. Output voltage (V_{OUT})
(Input voltage falling)

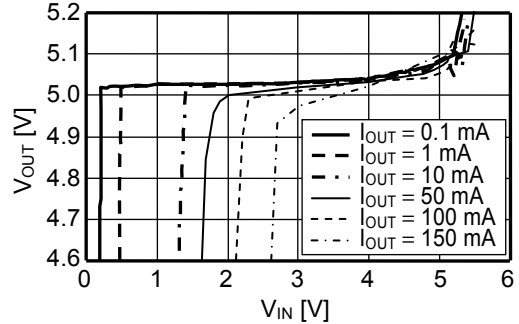

(c) Output current (I_{OUT}) vs. Output voltage (V_{OUT})

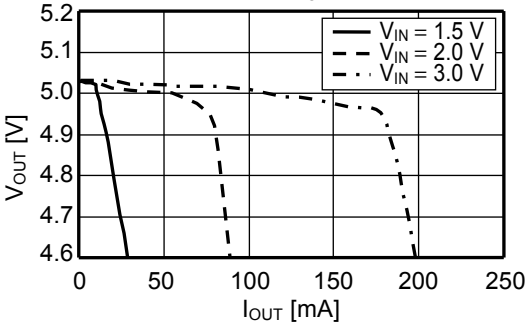

(d) Output current (I_{OUT}) vs. Efficiency (η)

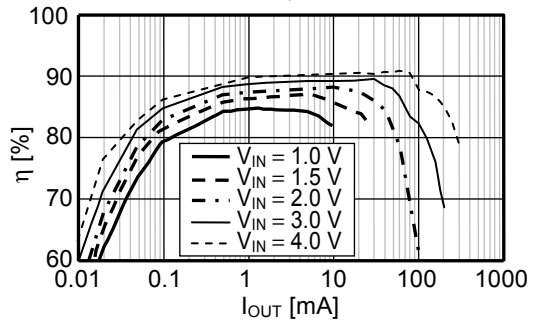

Condition 5 S-8351A50MC

(a) Input voltage (V_{IN}) vs. Output voltage (V_{OUT})
 (Input voltage raising)

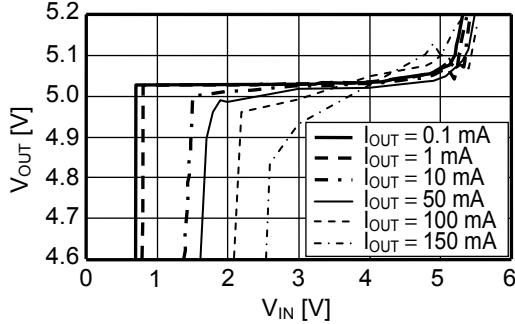

(b) Input voltage (V_{IN}) vs. Output voltage (V_{OUT})
 (Input voltage falling)

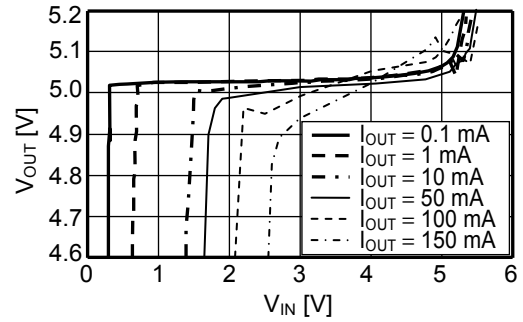

(c) Output current (I_{OUT}) vs. Output voltage (V_{OUT})

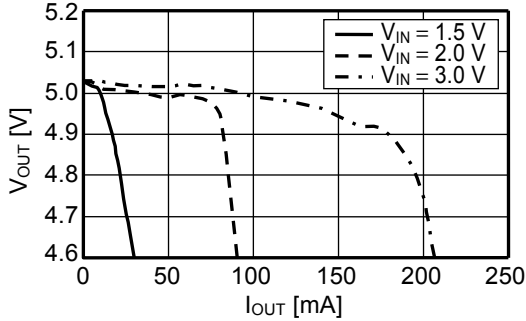

(d) Output current (I_{OUT}) vs. Efficiency (η)

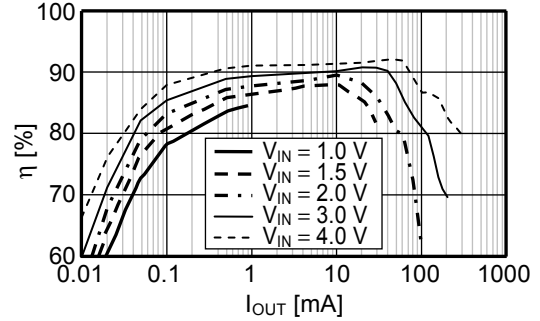

Condition 6 S-8351A50MC

(a) Input voltage (V_{IN}) vs. Output voltage (V_{OUT})
 (Input voltage raising)



(b) Input voltage (V_{IN}) vs. Output voltage (V_{OUT})
 (Input voltage falling)

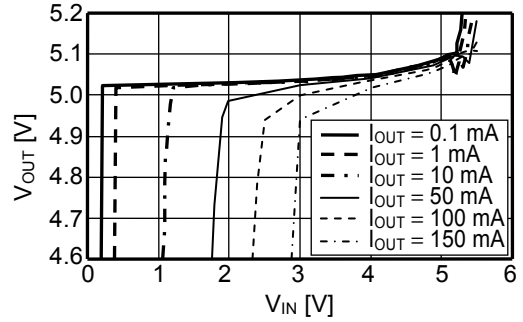

(c) Output current (I_{OUT}) vs. Output voltage (V_{OUT})

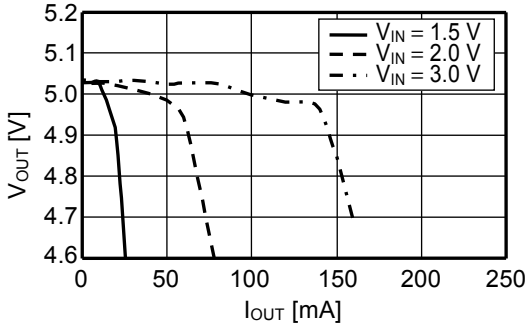

(d) Output current (I_{OUT}) vs. Efficiency (η)

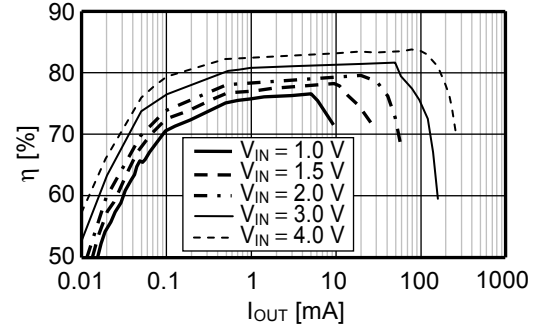

Condition 7 S-8352A30MC

(a) Input voltage (V_{IN}) vs. Output voltage (V_{OUT})
(Input voltage raising)

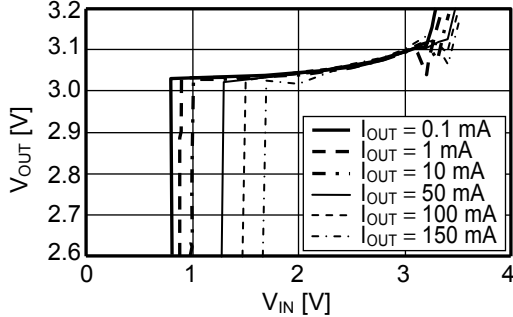

(b) Input voltage (V_{IN}) vs. Output voltage (V_{OUT})
(Input voltage falling)

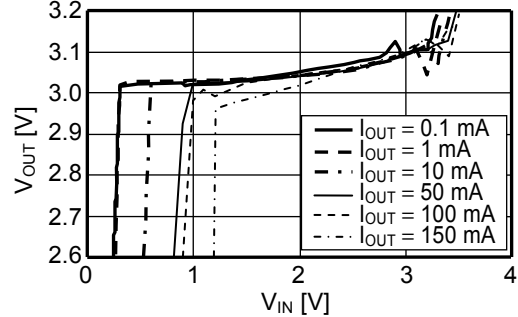

(c) Output current (I_{OUT}) vs. Output voltage (V_{OUT})

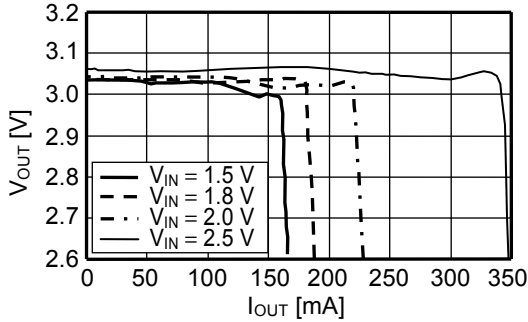

(d) Output current (I_{OUT}) vs. Efficiency (η)

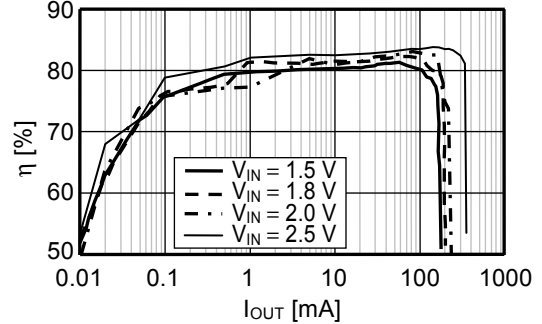

Condition 8 S-8352A30MC

(a) Input voltage (V_{IN}) vs. Output voltage (V_{OUT})
(Input voltage raising)

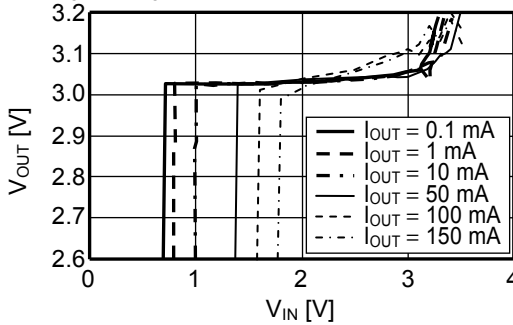

(b) Input voltage (V_{IN}) vs. Output voltage (V_{OUT})
(Input voltage falling)

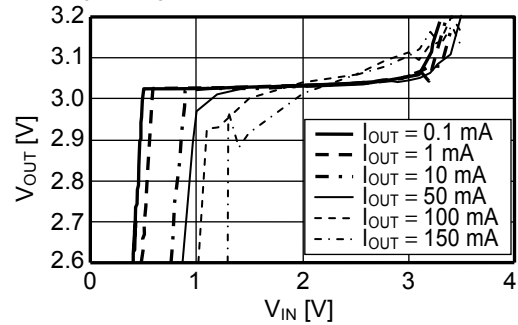

(c) Output current (I_{OUT}) vs. Output voltage (V_{OUT})

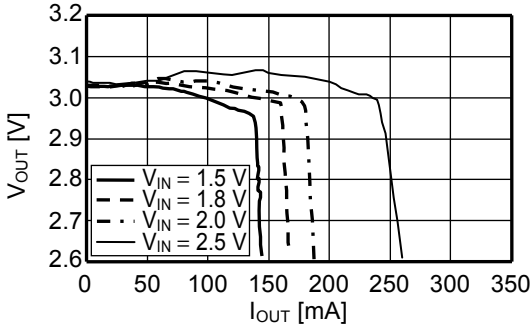

(d) Output current (I_{OUT}) vs. Efficiency (η)

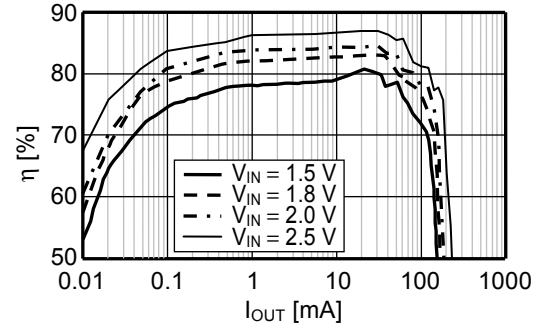

Condition 9 S-8352A30MC

(a) Input voltage (V_{IN}) vs. Output voltage (V_{OUT})
 (Input voltage raising)

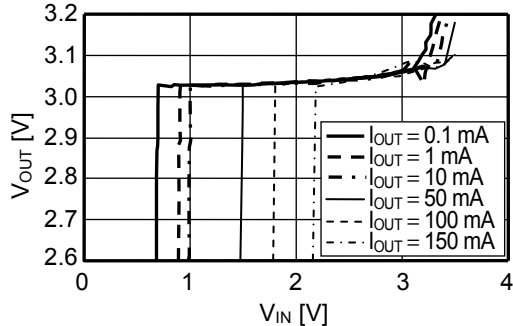

(b) Input voltage (V_{IN}) vs. Output voltage (V_{OUT})
 (Input voltage falling)

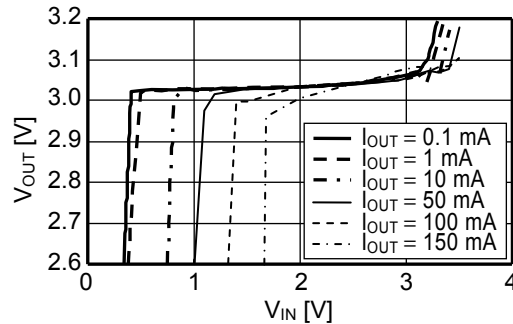

(c) Output current (I_{OUT}) vs. Output voltage (V_{OUT})

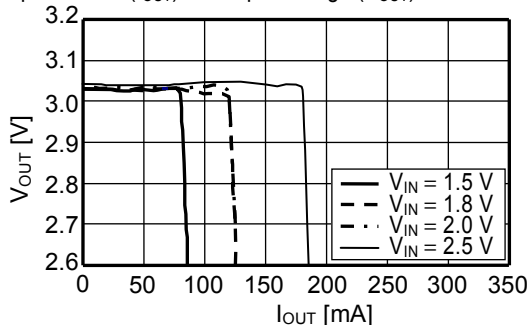

(d) Output current (I_{OUT}) vs. Efficiency (η)

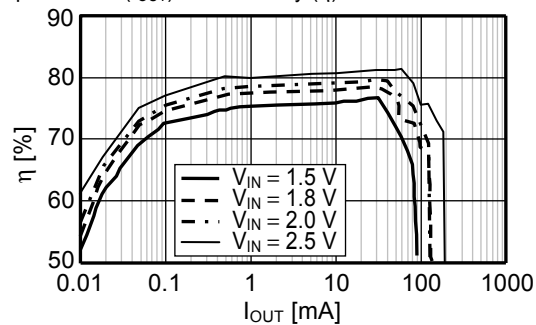

Condition 10 S-8352A50MC

(a) Input voltage (V_{IN}) vs. Output voltage (V_{OUT})
 (Input voltage raising)

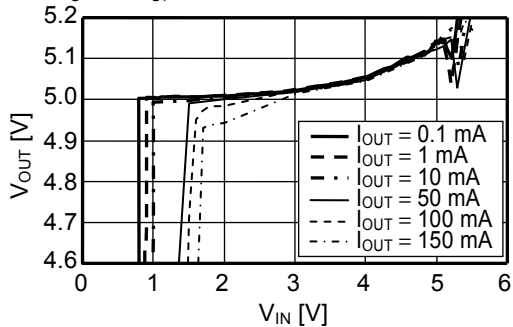

(b) Input voltage (V_{IN}) vs. Output voltage (V_{OUT})
 (Input voltage falling)

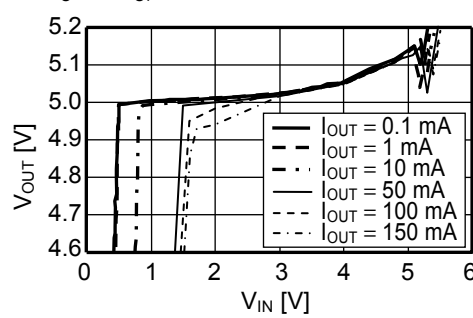

(c) Output current (I_{OUT}) vs. Output voltage (V_{OUT})

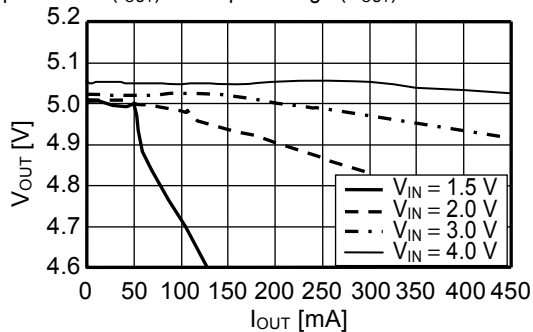

(d) Output current (I_{OUT}) vs. Efficiency (η)

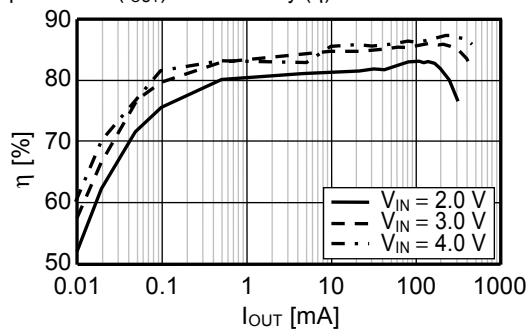

Condition 11 S-8352A50MC

(a) Input voltage (V_{IN}) vs. Output voltage (V_{OUT})
(Input voltage raising)

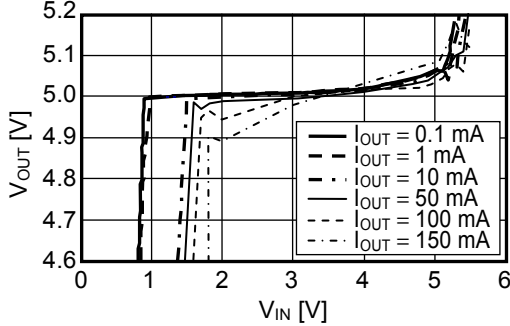

(b) Input voltage (V_{IN}) vs. Output voltage (V_{OUT})
(Input voltage falling)

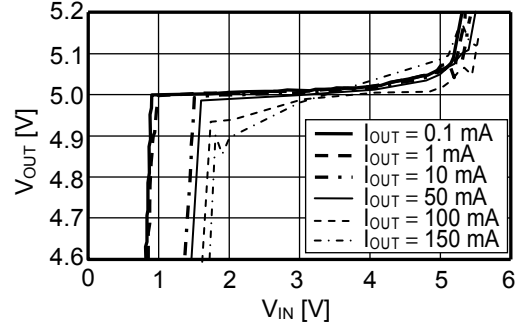

(c) Output current (I_{OUT}) vs. Output voltage (V_{OUT})

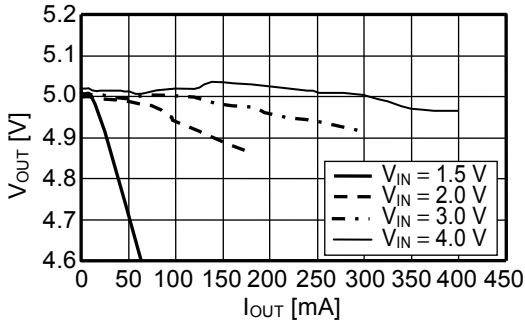

(d) Output current (I_{OUT}) vs. Efficiency (η)

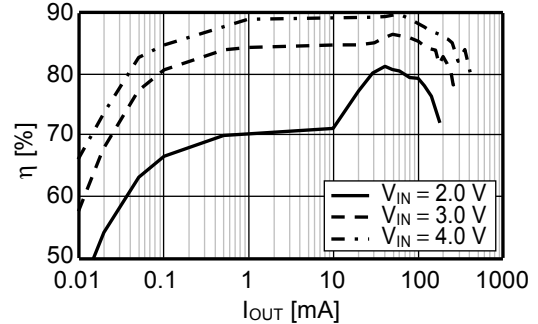

Condition 12 S-8352A50MC

(a) Input voltage (V_{IN}) vs. Output voltage (V_{OUT})
(Input voltage raising)

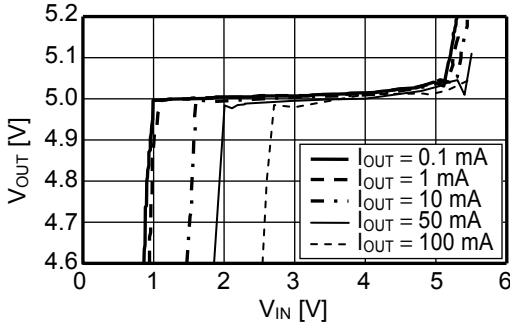

(b) Input voltage (V_{IN}) vs. Output voltage (V_{OUT})
(Input voltage falling)

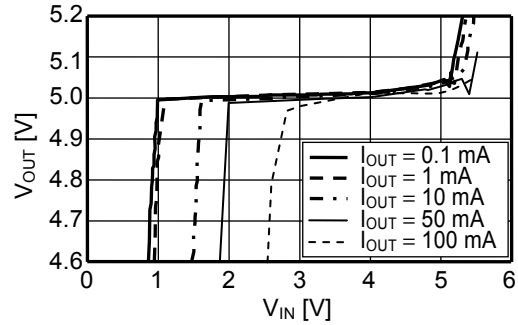

(c) Output current (I_{OUT}) vs. Output voltage (V_{OUT})

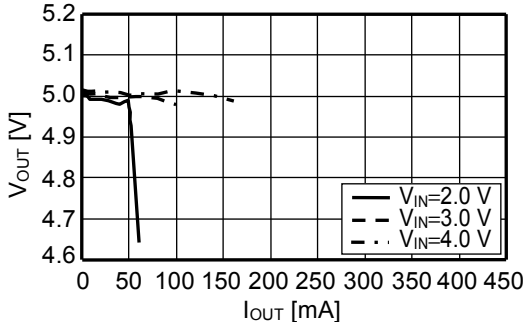

(d) Output current (I_{OUT}) vs. Efficiency (η)

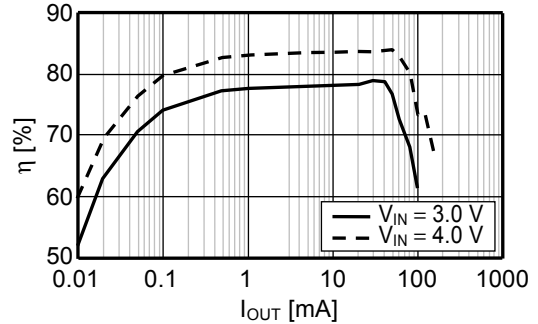

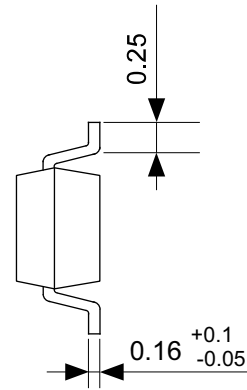

No. MP003-A-P-SD-1.2

TITLE	SOT233-A-PKG Dimensions
No.	MP003-A-P-SD-1.2
ANGLE	
UNIT	mm
ABLIC Inc.	

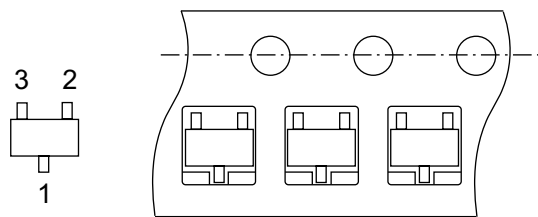
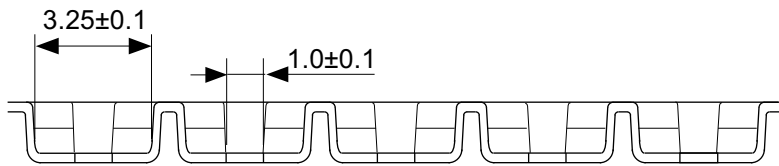

→
Feed direction

No. MP003-A-C-SD-2.0

TITLE	SOT233-A-Carrier Tape
No.	MP003-A-C-SD-2.0
ANGLE	
UNIT	mm
ABLIC Inc.	



Enlarged drawing in the central part

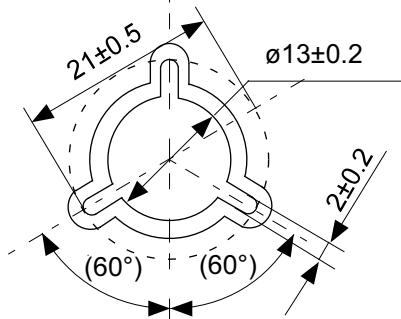

No. MP003-A-R-SD-1.1

TITLE	SOT233-A-Reel		
No.	MP003-A-R-SD-1.1		
ANGLE		QTY.	3,000
UNIT	mm		
ABLIC Inc.			

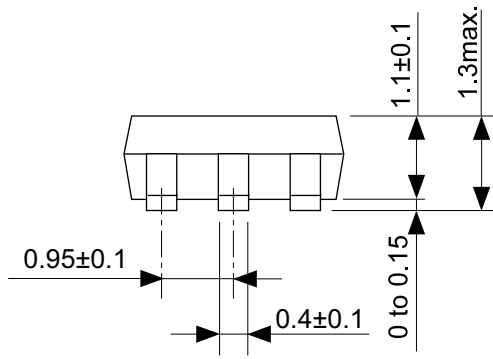

No. MP005-A-P-SD-1.3

TITLE	SOT235-A-PKG Dimensions
No.	MP005-A-P-SD-1.3
ANGLE	
UNIT	mm
ABLIC Inc.	



→ Feed direction

No. MP005-A-C-SD-2.1

TITLE	SOT235-A-Carrier Tape
No.	MP005-A-C-SD-2.1
ANGLE	
UNIT	mm
ABLIC Inc.	



Enlarged drawing in the central part



No. MP005-A-R-SD-1.1

TITLE	SOT235-A-Reel		
No.	MP005-A-R-SD-1.1		
ANGLE		QTY.	3,000
UNIT	mm		
ABLIC Inc.			

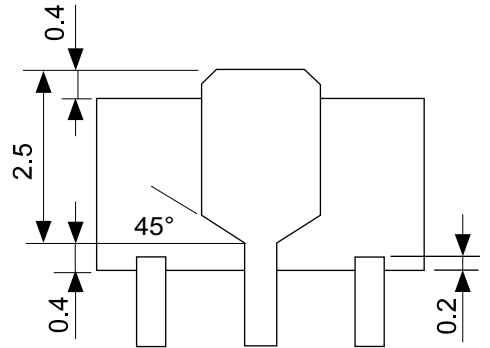

No. UP003-A-P-SD-2.0

TITLE	SOT893-A-PKG Dimensions
No.	UP003-A-P-SD-2.0
ANGLE	
UNIT	mm

ABLIC Inc.



→
Feed direction

No. UP003-A-C-SD-2.0

TITLE	SOT893-A-Carrier Tape
No.	UP003-A-C-SD-2.0
ANGLE	
UNIT	mm
ABLIC Inc.	



Enlarged drawing in the central part

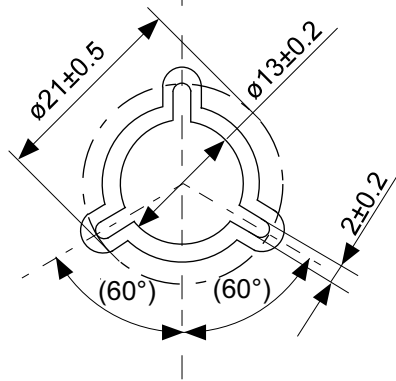

No. UP003-A-R-SD-1.1

TITLE	SOT893-A-Reel		
No.	UP003-A-R-SD-1.1		
ANGLE		QTY.	1,000
UNIT	mm		

ABLIC Inc.

Disclaimers (Handling Precautions)

1. All the information described herein (product data, specifications, figures, tables, programs, algorithms and application circuit examples, etc.) is current as of publishing date of this document and is subject to change without notice.
2. The circuit examples and the usages described herein are for reference only, and do not guarantee the success of any specific mass-production design.
ABLIC Inc. is not liable for any losses, damages, claims or demands caused by the reasons other than the products described herein (hereinafter "the products") or infringement of third-party intellectual property right and any other right due to the use of the information described herein.
3. ABLIC Inc. is not liable for any losses, damages, claims or demands caused by the incorrect information described herein.
4. Be careful to use the products within their ranges described herein. Pay special attention for use to the absolute maximum ratings, operation voltage range and electrical characteristics, etc.
ABLIC Inc. is not liable for any losses, damages, claims or demands caused by failures and / or accidents, etc. due to the use of the products outside their specified ranges.
5. Before using the products, confirm their applications, and the laws and regulations of the region or country where they are used and verify suitability, safety and other factors for the intended use.
6. When exporting the products, comply with the Foreign Exchange and Foreign Trade Act and all other export-related laws, and follow the required procedures.
7. The products are strictly prohibited from using, providing or exporting for the purposes of the development of weapons of mass destruction or military use. ABLIC Inc. is not liable for any losses, damages, claims or demands caused by any provision or export to the person or entity who intends to develop, manufacture, use or store nuclear, biological or chemical weapons or missiles, or use any other military purposes.
8. The products are not designed to be used as part of any device or equipment that may affect the human body, human life, or assets (such as medical equipment, disaster prevention systems, security systems, combustion control systems, infrastructure control systems, vehicle equipment, traffic systems, in-vehicle equipment, aviation equipment, aerospace equipment, and nuclear-related equipment), excluding when specified for in-vehicle use or other uses by ABLIC, Inc. Do not apply the products to the above listed devices and equipments.
ABLIC Inc. is not liable for any losses, damages, claims or demands caused by unauthorized or unspecified use of the products.
9. In general, semiconductor products may fail or malfunction with some probability. The user of the products should therefore take responsibility to give thorough consideration to safety design including redundancy, fire spread prevention measures, and malfunction prevention to prevent accidents causing injury or death, fires and social damage, etc. that may ensue from the products' failure or malfunction.
The entire system in which the products are used must be sufficiently evaluated and judged whether the products are allowed to apply for the system on customer's own responsibility.
10. The products are not designed to be radiation-proof. The necessary radiation measures should be taken in the product design by the customer depending on the intended use.
11. The products do not affect human health under normal use. However, they contain chemical substances and heavy metals and should therefore not be put in the mouth. The fracture surfaces of wafers and chips may be sharp. Be careful when handling these with the bare hands to prevent injuries, etc.
12. When disposing of the products, comply with the laws and ordinances of the country or region where they are used.
13. The information described herein contains copyright information and know-how of ABLIC Inc. The information described herein does not convey any license under any intellectual property rights or any other rights belonging to ABLIC Inc. or a third party. Reproduction or copying of the information from this document or any part of this document described herein for the purpose of disclosing it to a third-party is strictly prohibited without the express permission of ABLIC Inc.
14. For more details on the information described herein or any other questions, please contact ABLIC Inc.'s sales representative.
15. This Disclaimers have been delivered in a text using the Japanese language, which text, despite any translations into the English language and the Chinese language, shall be controlling.

2.4-2019.07