



■ **Block Diagrams**

**1. Nch Open-drain Output Products**



\*1. Parasitic diode

**Figure 1**

**2. CMOS Output Products**



\*1. Parasitic diode

**Figure 2**

■ **Product Name Structure**

The detection voltage, delay time, output form and packages for S-801 Series can be selected at the user's request. Refer to the "1. **Product name**" for the construction of the product name, "2. **Packages**" regarding the package drawings and "3. **Product Name List**" for the full product names.

**1. Product Name**

**1-1. SOT-23-5**



\*1. Refer to the tape drawing.

\*2. Refer to **Table 2** in "3. **Product name list**".

1-2. SNT-4A



\*1. Refer to the tape drawing.

\*2. Refer to **Table 2** in “**3. Product name list**”.

2. Packages

Package name	Drawing code			
	Package	Tape	Reel	Land
SOT-23-5	MP005-A-P-SD	MP005-A-C-SD	MP005-A-R-SD	—
SNT-4A	PF004-A-P-SD	PF004-A-C-SD	PF004-A-R-SD	PF004-A-L-SD

3. Product Name List

3-1. SOT-23-5

Table 1 (1/3)

Detection voltage range	Delay time	Nch open-drain output products	CMOS output products
2.2 V $\pm$ 2.0%	50 ms typ.	S-80122ANMC-JCHT2x	S-80122ALMC-JAHT2x
	100 ms typ.	S-80122BNMC-JGHT2x	S-80122BLMC-JEHT2x
	200 ms typ.	S-80122CNMC-JKHT2x	S-80122CLMC-JIHT2x
2.3 V $\pm$ 2.0%	50 ms typ.	S-80123ANMC-JCIT2x	S-80123ALMC-JAIT2x
	100 ms typ.	S-80123BNMC-JGIT2x	S-80123BLMC-JEIT2x
	200 ms typ.	S-80123CNMC-JKIT2x	S-80123CLMC-JIIT2x
2.4 V $\pm$ 2.0%	50 ms typ.	S-80124ANMC-JCJT2x	S-80124ALMC-JAJT2x
	100 ms typ.	S-80124BNMC-JGJT2x	S-80124BLMC-JEJT2x
	200 ms typ.	S-80124CNMC-JKJT2x	S-80124CLMC-JIJT2x
2.5 V $\pm$ 2.0%	50 ms typ.	S-80125ANMC-JCKT2x	S-80125ALMC-JAKT2x
	100 ms typ.	S-80125BNMC-JGKT2x	S-80125BLMC-JEKT2x
	200 ms typ.	S-80125CNMC-JKKT2x	S-80125CLMC-JIKT2x
2.6 V $\pm$ 2.0%	50 ms typ.	S-80126ANMC-JCLT2x	S-80126ALMC-JALT2x
	100 ms typ.	S-80126BNMC-JGLT2x	S-80126BLMC-JELT2x
	200 ms typ.	S-80126CNMC-JKLT2x	S-80126CLMC-JILT2x
2.7 V $\pm$ 2.0%	50 ms typ.	S-80127ANMC-JCMT2x	S-80127ALMC-JAMT2x
	100 ms typ.	S-80127BNMC-JGMT2x	S-80127BLMC-JEMT2x
	200 ms typ.	S-80127CNMC-JKMT2x	S-80127CLMC-JIMT2x
2.8 V $\pm$ 2.0%	50 ms typ.	S-80128ANMC-JCNT2x	S-80128ALMC-JANT2x
	100 ms typ.	S-80128BNMC-JGNT2x	S-80128BLMC-JENT2x
	200 ms typ.	S-80128CNMC-JKNT2x	S-80128CLMC-JINT2x
2.9 V $\pm$ 2.0%	50 ms typ.	S-80129ANMC-JCOT2x	S-80129ALMC-JAOT2x
	100 ms typ.	S-80129BNMC-JGOT2x	S-80129BLMC-JEOT2x
	200 ms typ.	S-80129CNMC-JKOT2x	S-80129CLMC-JIOT2x
3.0 V $\pm$ 2.0%	50 ms typ.	S-80130ANMC-JCPT2x	S-80130ALMC-JAPT2x
	100 ms typ.	S-80130BNMC-JGPT2x	S-80130BLMC-JEPT2x
	200 ms typ.	S-80130CNMC-JKPT2x	S-80130CLMC-JIPT2x
3.1 V $\pm$ 2.0%	50 ms typ.	S-80131ANMC-JCQT2x	S-80131ALMC-JAQT2x
	100 ms typ.	S-80131BNMC-JGQT2x	S-80131BLMC-JEQT2x
	200 ms typ.	S-80131CNMC-JKQT2x	S-80131CLMC-JIQT2x
3.2 V $\pm$ 2.0%	50 ms typ.	S-80132ANMC-JCRT2x	S-80132ALMC-JART2x
	100 ms typ.	S-80132BNMC-JGRT2x	S-80132BLMC-JERT2x
	200 ms typ.	S-80132CNMC-JKRT2x	S-80132CLMC-JIRT2x
3.3 V $\pm$ 2.0%	50 ms typ.	S-80133ANMC-JCST2x	S-80133ALMC-JAST2x
	100 ms typ.	S-80133BNMC-JGST2x	S-80133BLMC-JEST2x
	200 ms typ.	S-80133CNMC-JKST2x	S-80133CLMC-JIST2x
3.4 V $\pm$ 2.0%	50 ms typ.	S-80134ANMC-JCTT2x	S-80134ALMC-JATT2x
	100 ms typ.	S-80134BNMC-JGTT2x	S-80134BLMC-JETT2x
	200 ms typ.	S-80134CNMC-JKTT2x	S-80134CLMC-JITT2x

Table 1 (2/3)

Detection voltage range	Delay time	Nch open-drain output products	CMOS output products
3.5 V ±2.0%	50 ms typ.	S-80135ANMC-JCUT2x	S-80135ALMC-JAUT2x
	100 ms typ.	S-80135BNMC-JGUT2x	S-80135BLMC-JEUT2x
	200 ms typ.	S-80135CNMC-JKUT2x	S-80135CLMC-JIUT2x
3.6 V ±2.0%	50 ms typ.	S-80136ANMC-JCVT2x	S-80136ALMC-JAVT2x
	100 ms typ.	S-80136BNMC-JGVT2x	S-80136BLMC-JEVT2x
	200 ms typ.	S-80136CNMC-JKVT2x	S-80136CLMC-JIVT2x
3.7 V ±2.0%	50 ms typ.	S-80137ANMC-JCWT2x	S-80137ALMC-JAWT2x
	100 ms typ.	S-80137BNMC-JGWT2x	S-80137BLMC-JEWT2x
	200 ms typ.	S-80137CNMC-JKWT2x	S-80137CLMC-JIWT2x
3.8 V ±2.0%	50 ms typ.	S-80138ANMC-JCXT2x	S-80138ALMC-JAXT2x
	100 ms typ.	S-80138BNMC-JGXT2x	S-80138BLMC-JEXT2x
	200 ms typ.	S-80138CNMC-JKXT2x	S-80138CLMC-JIXT2x
3.9 V ±2.0%	50 ms typ.	S-80139ANMC-JCYT2x	S-80139ALMC-JAYT2x
	100 ms typ.	S-80139BNMC-JGYT2x	S-80139BLMC-JEYT2x
	200 ms typ.	S-80139CNMC-JKYT2x	S-80139CLMC-JIYT2x
4.0 V ±2.0%	50 ms typ.	S-80140ANMC-JCZT2x	S-80140ALMC-JAZT2x
	100 ms typ.	S-80140BNMC-JGZT2x	S-80140BLMC-JEZT2x
	200 ms typ.	S-80140CNMC-JKZT2x	S-80140CLMC-JIZT2x
4.1 V ±2.0%	50 ms typ.	S-80141ANMC-JC2T2x	S-80141ALMC-JA2T2x
	100 ms typ.	S-80141BNMC-JG2T2x	S-80141BLMC-JE2T2x
	200 ms typ.	S-80141CNMC-JK2T2x	S-80141CLMC-JI2T2x
4.2 V ±2.0%	50 ms typ.	S-80142ANMC-JC3T2x	S-80142ALMC-JA3T2x
	100 ms typ.	S-80142BNMC-JG3T2x	S-80142BLMC-JE3T2x
	200 ms typ.	S-80142CNMC-JK3T2x	S-80142CLMC-JI3T2x
4.3 V ±2.0%	50 ms typ.	S-80143ANMC-JC4T2x	S-80143ALMC-JA4T2x
	100 ms typ.	S-80143BNMC-JG4T2x	S-80143BLMC-JE4T2x
	200 ms typ.	S-80143CNMC-JK4T2x	S-80143CLMC-JI4T2x
4.4 V ±2.0%	50 ms typ.	S-80144ANMC-JC5T2x	S-80144ALMC-JA5T2x
	100 ms typ.	S-80144BNMC-JG5T2x	S-80144BLMC-JE5T2x
	200 ms typ.	S-80144CNMC-JK5T2x	S-80144CLMC-JI5T2x
4.5 V ±2.0%	50 ms typ.	S-80145ANMC-JC6T2x	S-80145ALMC-JA6T2x
	100 ms typ.	S-80145BNMC-JG6T2x	S-80145BLMC-JE6T2x
	200 ms typ.	S-80145CNMC-JK6T2x	S-80145CLMC-JI6T2x
4.6 V ±2.0%	50 ms typ.	S-80146ANMC-JC7T2x	S-80146ALMC-JA7T2x
	100 ms typ.	S-80146BNMC-JG7T2x	S-80146BLMC-JE7T2x
	200 ms typ.	S-80146CNMC-JK7T2x	S-80146CLMC-JI7T2x
4.7 V ±2.0%	50 ms typ.	S-80147ANMC-JC8T2x	S-80147ALMC-JA8T2x
	100 ms typ.	S-80147BNMC-JG8T2x	S-80147BLMC-JE8T2x
	200 ms typ.	S-80147CNMC-JK8T2x	S-80147CLMC-JI8T2x
4.8 V ±2.0%	50 ms typ.	S-80148ANMC-JC9T2x	S-80148ALMC-JA9T2x
	100 ms typ.	S-80148BNMC-JG9T2x	S-80148BLMC-JE9T2x
	200 ms typ.	S-80148CNMC-JK9T2x	S-80148CLMC-JI9T2x
4.9 V ±2.0%	50 ms typ.	S-80149ANMC-JDAT2x	S-80149ALMC-JBAT2x
	100 ms typ.	S-80149BNMC-JHAT2x	S-80149BLMC-JFAT2x
	200 ms typ.	S-80149CNMC-JLAT2x	S-80149CLMC-JJAT2x

Table 1 (3/3)

Detection voltage range	Delay time	Nch open-drain output products	CMOS output products
5.0 V $\pm$ 2.0%	50 ms typ.	S-80150ANMC-JDBT2x	S-80150ALMC-JBBT2x
	100 ms typ.	S-80150BNMC-JHBT2x	S-80150BLMC-JFBT2x
	200 ms typ.	S-80150CNMC-JLBT2x	S-80150CLMC-JJBT2x
5.1 V $\pm$ 2.0%	50 ms typ.	S-80151ANMC-JDCT2x	S-80151ALMC-JBCT2x
	100 ms typ.	S-80151BNMC-JHCT2x	S-80151BLMC-JFCT2x
	200 ms typ.	S-80151CNMC-JLCT2x	S-80151CLMC-JJCT2x
5.2 V $\pm$ 2.0%	50 ms typ.	S-80152ANMC-JDDT2x	S-80152ALMC-JBDT2x
	100 ms typ.	S-80152BNMC-JHDT2x	S-80152BLMC-JFDT2x
	200 ms typ.	S-80152CNMC-JLDT2x	S-80152CLMC-JJDT2x
5.3 V $\pm$ 2.0%	50 ms typ.	S-80153ANMC-JDET2x	S-80153ALMC-JBET2x
	100 ms typ.	S-80153BNMC-JHET2x	S-80153BLMC-JFET2x
	200 ms typ.	S-80153CNMC-JLET2x	S-80153CLMC-JJET2x
5.4 V $\pm$ 2.0%	50 ms typ.	S-80154ANMC-JDFT2x	S-80154ALMC-JBFT2x
	100 ms typ.	S-80154BNMC-JHFT2x	S-80154BLMC-JFFT2x
	200 ms typ.	S-80154CNMC-JLFT2x	S-80154CLMC-JJFT2x
5.5 V $\pm$ 2.0%	50 ms typ.	S-80155ANMC-JDGT2x	S-80155ALMC-JBGT2x
	100 ms typ.	S-80155BNMC-JHGT2x	S-80155BLMC-JFGT2x
	200 ms typ.	S-80155CNMC-JLGT2x	S-80155CLMC-JJGT2x
5.6 V $\pm$ 2.0%	50 ms typ.	S-80156ANMC-JDHT2x	S-80156ALMC-JBHT2x
	100 ms typ.	S-80156BNMC-JHHT2x	S-80156BLMC-JFHT2x
	200 ms typ.	S-80156CNMC-JLHT2x	S-80156CLMC-JJHT2x
5.7 V $\pm$ 2.0%	50 ms typ.	S-80157ANMC-JDIT2x	S-80157ALMC-JBIT2x
	100 ms typ.	S-80157BNMC-JHIT2x	S-80157BLMC-JFIT2x
	200 ms typ.	S-80157CNMC-JLIT2x	S-80157CLMC-JJIT2x
5.8 V $\pm$ 2.0%	50 ms typ.	S-80158ANMC-JDJT2x	S-80158ALMC-JBJT2x
	100 ms typ.	S-80158BNMC-JHJT2x	S-80158BLMC-JFJT2x
	200 ms typ.	S-80158CNMC-JLJT2x	S-80158CLMC-JJJT2x
5.9 V $\pm$ 2.0%	50 ms typ.	S-80159ANMC-JDKT2x	S-80159ALMC-JBKT2x
	100 ms typ.	S-80159BNMC-JHKT2x	S-80159BLMC-JFKT2x
	200 ms typ.	S-80159CNMC-JLKT2x	S-80159CLMC-JJKT2x
6.0 V $\pm$ 2.0%	50 ms typ.	S-80160ANMC-JDLT2x	S-80160ALMC-JBLT2x
	100 ms typ.	S-80160BNMC-JHLT2x	S-80160BLMC-JFLT2x
	200 ms typ.	S-80160CNMC-JLLT2x	S-80160CLMC-JJLT2x

Remark 1. x: G or U

2. Please select products of environmental code = U for Sn 100%, halogen-free products.

3-2. SNT-4A

Table 2 (1/3)

Detection voltage range	Delay time	Nch open-drain output products	CMOS output products
2.2 V ±2.0%	50 ms typ.	S-80122ANPF-JCHTFU	S-80122ALPF-JAHTFU
	100 ms typ.	S-80122BNPF-JGHTFU	S-80122BLPF-JEHTFU
	200 ms typ.	S-80122CNPF-JKHTFU	S-80122CLPF-JIHTFU
2.3 V ±2.0%	50 ms typ.	S-80123ANPF-JCITFU	S-80123ALPF-JAITFU
	100 ms typ.	S-80123BNPF-JGITFU	S-80123BLPF-JEITFU
	200 ms typ.	S-80123CNPF-JKITFU	S-80123CLPF-JIITFU
2.4 V ±2.0%	50 ms typ.	S-80124ANPF-JCJTFU	S-80124ALPF-JAJTFU
	100 ms typ.	S-80124BNPF-JGJTFU	S-80124BLPF-JEJTFU
	200 ms typ.	S-80124CNPF-JKJTFU	S-80124CLPF-JIJTFU
2.5 V ±2.0%	50 ms typ.	S-80125ANPF-JCKTFU	S-80125ALPF-JAKTFU
	100 ms typ.	S-80125BNPF-JGKTFU	S-80125BLPF-JEKTFU
	200 ms typ.	S-80125CNPF-JKKTFU	S-80125CLPF-JIKTFU
2.6 V ±2.0%	50 ms typ.	S-80126ANPF-JCLTFU	S-80126ALPF-JALTFU
	100 ms typ.	S-80126BNPF-JGLTFU	S-80126BLPF-JELTFU
	200 ms typ.	S-80126CNPF-JKLTUFU	S-80126CLPF-JILTFU
2.7 V ±2.0%	50 ms typ.	S-80127ANPF-JCMTFU	S-80127ALPF-JAMTFU
	100 ms typ.	S-80127BNPF-JGMTFU	S-80127BLPF-JEMTFU
	200 ms typ.	S-80127CNPF-JKMTFU	S-80127CLPF-JIMTFU
2.8 V ±2.0%	50 ms typ.	S-80128ANPF-JCNTFU	S-80128ALPF-JANTFU
	100 ms typ.	S-80128BNPF-JGNTFU	S-80128BLPF-JENTFU
	200 ms typ.	S-80128CNPF-JKNTFU	S-80128CLPF-JINTFU
2.9 V ±2.0%	50 ms typ.	S-80129ANPF-JCOTFU	S-80129ALPF-JAOTFU
	100 ms typ.	S-80129BNPF-JGOTFU	S-80129BLPF-JEOTFU
	200 ms typ.	S-80129CNPF-JKOTFU	S-80129CLPF-JIOTFU
3.0 V ±2.0%	50 ms typ.	S-80130ANPF-JCPTFU	S-80130ALPF-JAPTUFU
	100 ms typ.	S-80130BNPF-JGPTFU	S-80130BLPF-JEPTFU
	200 ms typ.	S-80130CNPF-JKPTFU	S-80130CLPF-JIPTFU
3.1 V ±2.0%	50 ms typ.	S-80131ANPF-JCQTFU	S-80131ALPF-JAQTFU
	100 ms typ.	S-80131BNPF-JGQTFU	S-80131BLPF-JEQTFU
	200 ms typ.	S-80131CNPF-JKQTFU	S-80131CLPF-JIQTFU
3.2 V ±2.0%	50 ms typ.	S-80132ANPF-JCRTFU	S-80132ALPF-JARTFU
	100 ms typ.	S-80132BNPF-JGRTFU	S-80132BLPF-JERTFU
	200 ms typ.	S-80132CNPF-JKRTFU	S-80132CLPF-JIRTFU
3.3 V ±2.0%	50 ms typ.	S-80133ANPF-JCSTFU	S-80133ALPF-JASTFU
	100 ms typ.	S-80133BNPF-JGSTFU	S-80133BLPF-JESTFU
	200 ms typ.	S-80133CNPF-JKSTFU	S-80133CLPF-JISTFU
3.4 V ±2.0%	50 ms typ.	S-80134ANPF-JCTTFU	S-80134ALPF-JATTFU
	100 ms typ.	S-80134BNPF-JGTTFU	S-80134BLPF-JETTFU
	200 ms typ.	S-80134CNPF-JKTTFU	S-80134CLPF-JITTFU
3.5 V ±2.0%	50 ms typ.	S-80135ANPF-JCUTFU	S-80135ALPF-JAUTFU
	100 ms typ.	S-80135BNPF-JGUTFU	S-80135BLPF-JEUTFU
	200 ms typ.	S-80135CNPF-JKUTFU	S-80135CLPF-JIUTFU
3.6 V ±2.0%	50 ms typ.	S-80136ANPF-JCVTFU	S-80136ALPF-JAVTFU
	100 ms typ.	S-80136BNPF-JGVTFU	S-80136BLPF-JEVTFU
	200 ms typ.	S-80136CNPF-JKVTFU	S-80136CLPF-JIVTFU
3.7 V ±2.0%	50 ms typ.	S-80137ANPF-JCWTFU	S-80137ALPF-JAWTFU
	100 ms typ.	S-80137BNPF-JGWTFU	S-80137BLPF-JEWTFU
	200 ms typ.	S-80137CNPF-JKWTFU	S-80137CLPF-JIWTFU



Table 2 (2/3)

Detection voltage range	Delay time	Nch open-drain output products	CMOS output products
3.8 V $\pm$ 2.0%	50 ms typ.	S-80138ANPF-JCXTFU	S-80138ALPF-JAXTFU
	100 ms typ.	S-80138BNPF-JGXTFU	S-80138BLPF-JEXTFU
	200 ms typ.	S-80138CNPF-JKXTFU	S-80138CLPF-JIXTFU
3.9 V $\pm$ 2.0%	50 ms typ.	S-80139ANPF-JCYTFU	S-80139ALPF-JAYTFU
	100 ms typ.	S-80139BNPF-JGYTFU	S-80139BLPF-JEYTFU
	200 ms typ.	S-80139CNPF-JKYTFU	S-80139CLPF-JIYTFU
4.0 V $\pm$ 2.0%	50 ms typ.	S-80140ANPF-JCZTFU	S-80140ALPF-JAZTFU
	100 ms typ.	S-80140BNPF-JGZTFU	S-80140BLPF-JEZTFU
	200 ms typ.	S-80140CNPF-JKZTFU	S-80140CLPF-JIZTFU
4.1 V $\pm$ 2.0%	50 ms typ.	S-80141ANPF-JC2TFU	S-80141ALPF-JA2TFU
	100 ms typ.	S-80141BNPF-JG2TFU	S-80141BLPF-JE2TFU
	200 ms typ.	S-80141CNPF-JK2TFU	S-80141CLPF-JI2TFU
4.2 V $\pm$ 2.0%	50 ms typ.	S-80142ANPF-JC3TFU	S-80142ALPF-JA3TFU
	100 ms typ.	S-80142BNPF-JG3TFU	S-80142BLPF-JE3TFU
	200 ms typ.	S-80142CNPF-JK3TFU	S-80142CLPF-JI3TFU
4.3 V $\pm$ 2.0%	50 ms typ.	S-80143ANPF-JC4TFU	S-80143ALPF-JA4TFU
	100 ms typ.	S-80143BNPF-JG4TFU	S-80143BLPF-JE4TFU
	200 ms typ.	S-80143CNPF-JK4TFU	S-80143CLPF-JI4TFU
4.4 V $\pm$ 2.0%	50 ms typ.	S-80144ANPF-JC5TFU	S-80144ALPF-JA5TFU
	100 ms typ.	S-80144BNPF-JG5TFU	S-80144BLPF-JE5TFU
	200 ms typ.	S-80144CNPF-JK5TFU	S-80144CLPF-JI5TFU
4.5 V $\pm$ 2.0%	50 ms typ.	S-80145ANPF-JC6TFU	S-80145ALPF-JA6TFU
	100 ms typ.	S-80145BNPF-JG6TFU	S-80145BLPF-JE6TFU
	200 ms typ.	S-80145CNPF-JK6TFU	S-80145CLPF-JI6TFU
4.6 V $\pm$ 2.0%	50 ms typ.	S-80146ANPF-JC7TFU	S-80146ALPF-JA7TFU
	100 ms typ.	S-80146BNPF-JG7TFU	S-80146BLPF-JE7TFU
	200 ms typ.	S-80146CNPF-JK7TFU	S-80146CLPF-JI7TFU
4.7 V $\pm$ 2.0%	50 ms typ.	S-80147ANPF-JC8TFU	S-80147ALPF-JA8TFU
	100 ms typ.	S-80147BNPF-JG8TFU	S-80147BLPF-JE8TFU
	200 ms typ.	S-80147CNPF-JK8TFU	S-80147CLPF-JI8TFU
4.8 V $\pm$ 2.0%	50 ms typ.	S-80148ANPF-JC9TFU	S-80148ALPF-JA9TFU
	100 ms typ.	S-80148BNPF-JG9TFU	S-80148BLPF-JE9TFU
	200 ms typ.	S-80148CNPF-JK9TFU	S-80148CLPF-JI9TFU
4.9 V $\pm$ 2.0%	50 ms typ.	S-80149ANPF-JDATFU	S-80149ALPF-JBATFU
	100 ms typ.	S-80149BNPF-JHATFU	S-80149BLPF-JFATFU
	200 ms typ.	S-80149CNPF-JLATFU	S-80149CLPF-JJATFU
5.0 V $\pm$ 2.0%	50 ms typ.	S-80150ANPF-JDBTFU	S-80150ALPF-JBBTFU
	100 ms typ.	S-80150BNPF-JHBTFU	S-80150BLPF-JFBTFU
	200 ms typ.	S-80150CNPF-JLBTFU	S-80150CLPF-JJBTFU
5.1 V $\pm$ 2.0%	50 ms typ.	S-80151ANPF-JDCTFU	S-80151ALPF-JBCTFU
	100 ms typ.	S-80151BNPF-JHCTFU	S-80151BLPF-JFCTFU
	200 ms typ.	S-80151CNPF-JLCTFU	S-80151CLPF-JJCTFU
5.2 V $\pm$ 2.0%	50 ms typ.	S-80152ANPF-JDDTFU	S-80152ALPF-JBDTFU
	100 ms typ.	S-80152BNPF-JHDTFU	S-80152BLPF-JFDTFU
	200 ms typ.	S-80152CNPF-JLDTFU	S-80152CLPF-JJDTFU
5.3 V $\pm$ 2.0%	50 ms typ.	S-80153ANPF-JDETFU	S-80153ALPF-JBETFU
	100 ms typ.	S-80153BNPF-JHETFU	S-80153BLPF-JFETFU
	200 ms typ.	S-80153CNPF-JLETFU	S-80153CLPF-JJETFU

Table 2 (3/3)

Detection voltage range	Delay time	Nch open-drain output products	CMOS output products
5.4 V $\pm$ 2.0%	50 ms typ.	S-80154ANPF-JDFTFU	S-80154ALPF-JBFTFU
	100 ms typ.	S-80154BNPF-JHFTFU	S-80154BLPF-JFFTFU
	200 ms typ.	S-80154CNPF-JLFTFU	S-80154CLPF-JJFTFU
5.5 V $\pm$ 2.0%	50 ms typ.	S-80155ANPF-JDGTFU	S-80155ALPF-JBGTFU
	100 ms typ.	S-80155BNPF-JHGTFU	S-80155BLPF-JFUTFU
	200 ms typ.	S-80155CNPF-JLGTFU	S-80155CLPF-JJGTFU
5.6 V $\pm$ 2.0%	50 ms typ.	S-80156ANPF-JDHTFU	S-80156ALPF-JBHTFU
	100 ms typ.	S-80156BNPF-JHHTFU	S-80156BLPF-JFHTFU
	200 ms typ.	S-80156CNPF-JLHTFU	S-80156CLPF-JJHTFU
5.7 V $\pm$ 2.0%	50 ms typ.	S-80157ANPF-JDITFU	S-80157ALPF-JBITFU
	100 ms typ.	S-80157BNPF-JHITFU	S-80157BLPF-JFITFU
	200 ms typ.	S-80157CNPF-JLITFU	S-80157CLPF-JJITFU
5.8 V $\pm$ 2.0%	50 ms typ.	S-80158ANPF-JDJTFU	S-80158ALPF-JBJTFU
	100 ms typ.	S-80158BNPF-JHJTFU	S-80158BLPF-JFJTFU
	200 ms typ.	S-80158CNPF-JLJTFU	S-80158CLPF-JJJTFU
5.9 V $\pm$ 2.0%	50 ms typ.	S-80159ANPF-JDKTFU	S-80159ALPF-JBKTFU
	100 ms typ.	S-80159BNPF-JHKTFU	S-80159BLPF-JFKTFU
	200 ms typ.	S-80159CNPF-JLKTFU	S-80159CLPF-JJKTFU
6.0 V $\pm$ 2.0%	50 ms typ.	S-80160ANPF-JDLTFU	S-80160ALPF-JBLTFU
	100 ms typ.	S-80160BNPF-JHLTFU	S-80160BLPF-JFLTUFU
	200 ms typ.	S-80160CNPF-JLLTFU	S-80160CLPF-JJLTFU

■ Pin Configurations



Figure 3

- \*1. Refer to “2. Delay Circuit” in “■ Operation” for operation.
- \*2. The NC pin is electrically open.  
The NC pin can be connected to VDD or VSS.

Table 3

Pin No.	Pin name	Pin description
1	DS*1	ON/OFF switch for delay time
2	VSS	GND pin
3	NC*2	No connection
4	OUT	Voltage detection output pin
5	VDD	Voltage input pin

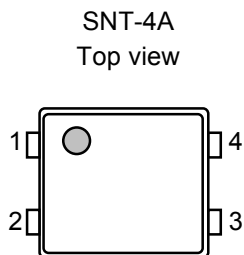

Figure 4

- \*1. Refer to “2. Delay Circuit” in “■ Operation” for operation.

Table 4

Pin No.	Pin name	Pin description
1	VSS	GND pin
2	DS*1	ON/OFF switch for delay time
3	VDD	Voltage input pin
4	OUT	Voltage detection output pin

■ Absolute Maximum Ratings

Table 5

(Ta=25°C unless otherwise specified)

Item	Symbol	Absolute maximum ratings	Unit
Power supply voltage	$V_{DD}-V_{SS}$	12	V
Output voltage	Nch open-drain output products CMOS output products	$V_{OUT}$	$V_{SS}-0.3$ to $V_{SS}+12$
			$V_{SS}-0.3$ to $V_{DD}+0.3$
Output current	$I_{OUT}$	50	mA
Power dissipation	SOT-23-5	$P_D$	250 (When not mounted on board)
			600*1
	SNT-4A		140 (When not mounted on board)
			300*1
Operating ambient temperature	$T_{opr}$	-40 to +85	°C
Storage temperature	$T_{stg}$	-40 to +125	

\*1. When mounted on board

[Mounted board]

- (1) Board size: 114.3 mm × 76.2 mm × t1.6 mm
- (2) Board name: JEDEC STANDARD51-7

**Caution** The absolute maximum ratings are rated values exceeding which the product could suffer physical damage. These values must therefore not be exceeded under any conditions.



Figure 5 Power Dissipation of Package (When Mounted on Board)

■ Electrical Characteristics

Table 6

(Ta=25 °C Unless otherwise specified)

Item	Symbol	Condition	Min.	Typ.	Max.	Unit	Test circuit	
Detection voltage*1	$-V_{DET}$	—	$-V_{DET(S)} \times 0.98$	$-V_{DET(S)}$	$-V_{DET(S)} \times 1.02$	V	1	
Hysteresis width	$V_{HYS}$	—	30	60	100	mV		
Current consumption	$I_{SS}$	$V_{DD}=3.5\text{ V}$	S-80122 to 26	—	1.3	3.3	$\mu\text{A}$	
		$V_{DD}=4.5\text{ V}$	S-80127 to 39	—	1.5	3.5		
		$V_{DD}=6.5\text{ V}$	S-80140 to 60	—	1.8	4.0		
Operating voltage	$V_{DD}$	—	0.95	—	10.0	V		
Output current	$I_{OUT}$	Output transistor, Nch, $V_{OUT}=0.5\text{ V}$	$V_{DD}=1.2\text{ V}$ S-80122 to 60	0.75	1.5	—	mA	2
			$V_{DD}=2.4\text{ V}$ S-80127 to 60	3.0	6.0	—		
		Only for CMOS output products, Output transistor, Pch, $V_{DD}-V_{OUT}=0.5\text{ V}$	$V_{DD}=4.8\text{ V}$ S-80122 to 39	1.0	2.0	—		
			$V_{DD}=6.0\text{ V}$ S-80140 to 54	1.25	2.5	—		
Leakage current	$I_{LEAK}$	Only for Nch open-drain output products, Output transistor, Nch, $V_{DD}=10.0\text{ V}$ , $V_{OUT}=10.0\text{ V}$	—	—	0.1	$\mu\text{A}$		
			—	—	0.1	$\mu\text{A}$		
Detection voltage temperature coefficient*2	$\frac{\Delta - V_{DET}}{\Delta Ta \bullet -V_{DET}}$	Ta=−40 °C to +85 °C	—	$\pm 120$	$\pm 360$	ppm/°C	1	
Delay time 1	$t_{D1}$	$V_{DD}=-V_{DET}+1\text{ V}$ , DS pin Low	S-801xxAx	32.5	50	72.5	ms	
			S-801xxBx	65	100	145		
			S-801xxCx	130	200	290		
Delay time 2	$t_{D2}$	$V_{DD}=-V_{DET}+1\text{ V}$ , DS pin High	110	220	330	$\mu\text{s}$	3	
Input voltage	$V_{SH}$	DS pin, $V_{DD}=6.0\text{ V}$	1.0	—	—	V	4	
	$V_{SL}$	DS pin, $V_{DD}=6.0\text{ V}$	—	—	0.3			

\*1.  $-V_{DET}$ : Actual detection voltage value,  $-V_{DET(S)}$ : Specified detection voltage value (The center value of the detection voltage range in **Table 1 to 2**.)

\*2. Temperature change ratio for the detection voltage [mV/°C] is calculated using the following equation.

$$\frac{\Delta - V_{DET}}{\Delta Ta} [\text{mV}/^\circ\text{C}]^{*1} = -V_{DET(S)}(\text{Typ.})[\text{V}]^{*2} \times \frac{\Delta - V_{DET}}{\Delta Ta \bullet -V_{DET}} [\text{ppm}/^\circ\text{C}]^{*3} \div 1000$$

\*1. Temperature change ratio of the detection voltage

\*2. Specified detection voltage value

\*3. Detection voltage temperature coefficient

■ Test Circuits

1.



\*1. R is unnecessary for CMOS output products.

Figure 6

2.



Figure 7

3.



\*1. R is unnecessary for CMOS output products.

Figure 8

4.



\*1. R is unnecessary for CMOS output products.

Figure 9

■ Operation

1. Basic Operation: CMOS Output (Active Low)

- 1-1. When the power supply voltage ( $V_{DD}$ ) is higher than the release voltage ( $+V_{DET}$ ), the Nch transistor is OFF and the Pch transistor is ON to provide  $V_{DD}$  (high) at the output. Since the Nch transistor N1 in **Figure 10** is OFF, the comparator input voltage is  $\frac{(R_B + R_C) \cdot V_{DD}}{R_A + R_B + R_C}$ .
- 1-2. When the  $V_{DD}$  goes below  $+V_{DET}$ , the output provides the  $V_{DD}$  level, as long as  $V_{DD}$  remains above the detection voltage ( $-V_{DET}$ ). When the  $V_{DD}$  falls below  $-V_{DET}$  (point A in **Figure 11**), the Nch transistor becomes ON, the Pch transistor becomes OFF, and the  $V_{SS}$  level appears at the output. At this time the Nch transistor N1 in **Figure 10** becomes ON, the comparator input voltage is changed to  $\frac{R_B \cdot V_{DD}}{R_A + R_B}$ .
- 1-3. When the  $V_{DD}$  falls below the minimum operating voltage, the output becomes undefined, or goes to  $V_{DD}$  when the output is pulled up to  $V_{DD}$ .
- 1-4. The  $V_{SS}$  level appears when  $V_{DD}$  rises above the minimum operating voltage. The  $V_{SS}$  level still appears even when  $V_{DD}$  surpasses the  $-V_{DET}$ , as long as it does not exceed the release voltage  $+V_{DET}$ .
- 1-5. When  $V_{DD}$  rises above  $+V_{DET}$  (point B in **Figure 11**), the Nch transistor becomes OFF and the Pch transistor becomes ON to provide  $V_{DD}$  at the output. The  $V_{DD}$  at the OUT pin is delayed for  $t_d$  due to the delay circuit.



\*1. Paracitic diode

Figure 10 Operation 1



Figure 11 Operation 2

## 2. Delay Circuit

### 2-1. Delay Time

The delay circuit delays the output signal from the time at which the power voltage ( $V_{DD}$ ) exceeds the release voltage ( $+V_{DET}$ ) when  $V_{DD}$  is turned on. The output signal is not delayed when the  $V_{DD}$  goes below the detection voltage ( $-V_{DET}$ ). (Refer to **Figure 11**.)

The delay time ( $t_D$ ) is a fixed value that is determined by a built-in oscillation circuit and counter.

### 2-2. DS Pin (ON/OFF Switch Pin for Delay Time)

The DS pin should be connected to Low or High. When the DS pin is High, the output delay time becomes short since the output signal is taken from the middle of counter circuit (Refer to **Figure 16**).

## 3. Other Characteristics

### 3-1. Temperature Characteristics of Detection Voltage

The shaded area in **Figure 12** shows the temperature characteristics of the detection voltage.



Figure 12 Temperature Characteristics of Detection Voltage (Example for S-80122xxxx)



### 3-2. Temperature Characteristics of Release Voltage

The temperature coefficient  $\frac{\Delta + V_{DET}}{\Delta Ta}$  of the release voltage is calculated by the temperature coefficient  $\frac{\Delta - V_{DET}}{\Delta Ta}$  for the detection voltage as follows:

$$\frac{\Delta + V_{DET}}{\Delta Ta} = \frac{+V_{DET}}{-V_{DET}} \times \frac{\Delta - V_{DET}}{\Delta Ta}$$

The temperature coefficients for the release voltage and the detection voltage have the same sign consequently.

### 3-3. Temperature Characteristics of Hysteresis Voltage

The temperature characteristics for the hysteresis voltage is expressed as  $\frac{\Delta + V_{DET}}{\Delta Ta} - \frac{\Delta - V_{DET}}{\Delta Ta}$  and is calculated as follows:

$$\frac{\Delta + V_{DET}}{\Delta Ta} - \frac{\Delta - V_{DET}}{\Delta Ta} = \frac{V_{HYS}}{-V_{DET}} \times \frac{\Delta - V_{DET}}{\Delta Ta}$$

## ■ Standard Circuit



\*1. R is unnecessary for CMOS output products.

Figure 13

**Caution** The above connection diagram and constant will not guarantees successful operation. Perform through using the actual application to set the constant.

■ Technical Terms

1. Detection Voltage ( $-V_{DET}$ ), Release Voltage ( $+V_{DET}$ )

The detection voltage ( $-V_{DET}$ ) is a voltage at which the output turns to low. The detection voltage varies slightly among products of the same specification. The variation of detection voltage between the specified minimum ( $-V_{DET}$ ) Min. and the maximum ( $-V_{DET}$ ) Max. is called the detection voltage range (Refer to **Figure 14**).

e.g. For the S-80122AN, the detection voltage lies in the range of  $2.156 \leq -V_{DET} \leq 2.244$ .  
 This means that some S-80122ANs have 2.156 V for  $-V_{DET}$  and some have 2.244 V.

The release voltage ( $+V_{DET}$ ) is a voltage at which the output turns to high. The release voltage varies slightly among products of the same specification. The variation of release voltages between the specified minimum ( $+V_{DET}$ ) Min. and the maximum ( $+V_{DET}$ ) Max. is called the release voltage range (Refer to **Figure 15**).

e.g. For the S-80122AN, the release voltage lies in the range of  $2.186 \leq +V_{DET} \leq 2.344$ .  
 This means that some S-80122ANs have 2.186 V for  $+V_{DET}$  and some have 2.344 V.



**Figure 14** Detection Voltage



**Figure 15** Release Voltage

**Remark** Although the detection voltage and release voltage overlap in the range of 2.186 V to 2.244 V,  $+V_{DET}$  is always larger than  $-V_{DET}$ .

**2. Hysteresis Width ( $V_{HYS}$ )**

Hysteresis width is the voltage difference between the detection voltage and the release voltage (The voltage at point B–The voltage at point A= $V_{HYS}$  in **Figure 11**). The existence of the hysteresis width prevents malfunction caused by noise on input signal.

**3. Delay Time ( $t_D$ )**

Delay time is a time internally measured from the instant at which input voltage to the VDD pin exceeds the release voltage ( $+V_{DET}$ ) to the point at which the output of the OUT pin inverts. The delay time is fixed in each series distinguished by A, B and C.

S-801xxAx series: typ. 50 ms

S-801xxBx series: typ. 100 ms

S-801xxCx series: typ. 200 ms

The output of the OUT pin can be inverted in a short delay time ( $t_{D2}$ ) by setting the DS pin High (Refer to **Figure 16**).



**Figure 16**

**4. Through-type Current**

The through-type current refers to the current that flows instantaneously at the time of detection and release of a voltage detector. The through-type current flows at a frequency of 20 kHz during release delay time since the internal logic circuit operates.

## 5. Oscillation

In applications where a resistor is connected to the voltage detector input (**Figure 17**), taking a CMOS active low products for example, the through-type current which is generated when the output goes from low to high (release) causes a voltage drop equal to [through-type current]  $\times$  [input resistance] across the resistor. When the input voltage drops below the detection voltage ( $-V_{DET}$ ) as a result, the output voltage goes to low level. In this state, the through-type current stops and its resultant voltage drop disappears, and the output goes from low to high. The through-type current is again generated, a voltage drop appears, and repeating the process finally induces oscillation.



**Figure 17 Example for Bad Implementation of Input Voltage Divider**

## ■ Precautions

- In the S-801 series products, the through-type current flows at a frequency of 20 kHz approximately during the delay time since the internal oscillator circuit and counter timer operate at voltage release. High impedance in the input may cause oscillation by the through-type current. When the input impedance is high, insert a capacitor between VDD pin and VSS pin to prevent oscillation.
- Do not apply an electrostatic discharge to this IC that exceeds the performance ratings of the built-in electrostatic protection circuit.
- In CMOS output products of the S-801 Series, the through-type current flows at detection and release. If the impedance is high, oscillation may occur due to the voltage drop by the through-type current during releasing.
- When designing for mass production using an application circuit described herein, the product deviation and temperature characteristics should be taken into consideration. ABLIC Inc. shall not bear any responsibility for the patents on the circuits described herein.
- ABLIC Inc. claims no responsibility for any and all disputes arising out of or in connection with any infringement of the products including this IC upon patents owned a third party.

■ Typical Characteristics (Typical Data)

1. Detection Voltage ( $V_{DET}$ ) - Temperature ( $T_a$ )

S-80122AL



S-80160AL



2. Hysteresis Voltage Width ( $V_{HYS}$ ) - Temperature ( $T_a$ )

S-80122AL



S-80160AL



3. Current Consumption ( $I_{SS}$ ) - Input Voltage ( $V_{DD}$ )

(a) S-80122AL



(b) S-80129AL



(c) S-80130AL



(d) S-80160AL



**4. Current Consumption ( $I_{SS}$ ) - Temperature ( $T_a$ )**

(a) S-80122AL



(b) S-80129AL



(c) S-80130AL



(d) S-80160AL



**5. Nch Transistor Output Current ( $I_{OUT}$ ) -  $V_{OUT}$**   
S-80160AL



**6. Pch Transistor Output Current ( $I_{OUT}$ ) - ( $V_{DD}$ - $V_{OUT}$ )**  
S-80122AL



**7. Nch Transistor Output Current ( $I_{OUT}$ ) - Input Voltage ( $V_{DD}$ )**  
S-80160AL



**8. Pch transistor Output Current ( $I_{OUT}$ ) - Input Voltage ( $V_{DD}$ )**  
S-80122AL



**9. Minimum Operating Voltage - Input Voltage ( $V_{DD}$ )**

S-80122AN



**10. Threshold Voltage of DS Pin - Temperature ( $T_a$ )**

S-80122AL



**11. Threshold Voltage of DS Pin - Input Voltage ( $V_{DD}$ )**

S-80122AL



**12. Delay Time 1 - Temperature ( $T_a$ )**

S-80122CL

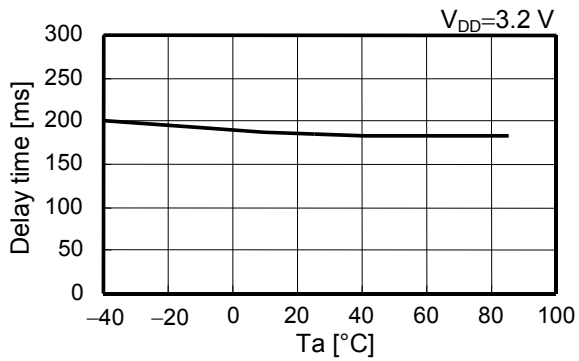

S-80160CL



**13. Delay Time 1 - Input Voltage ( $V_{DD}$ )**

S-80122CL



14. Delay Time 2 - Temperature (Ta)

S-80122AL

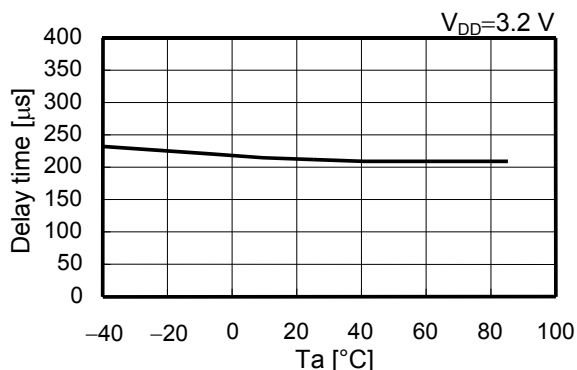

S-80160AL

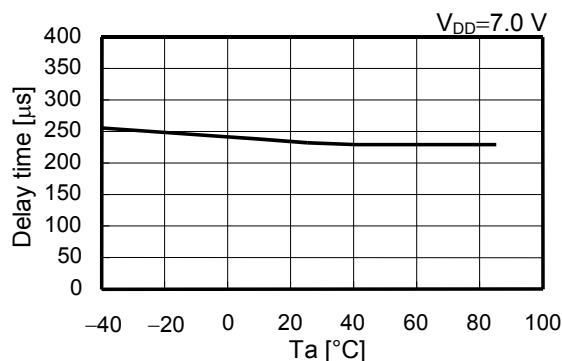

15. Delay Time 2 - Input Voltage (VDD)

S-80122AN

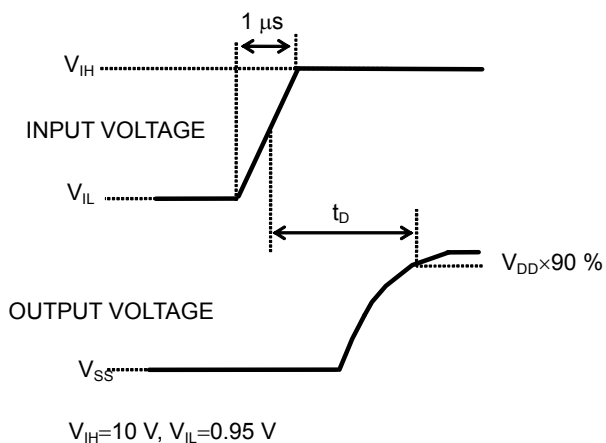
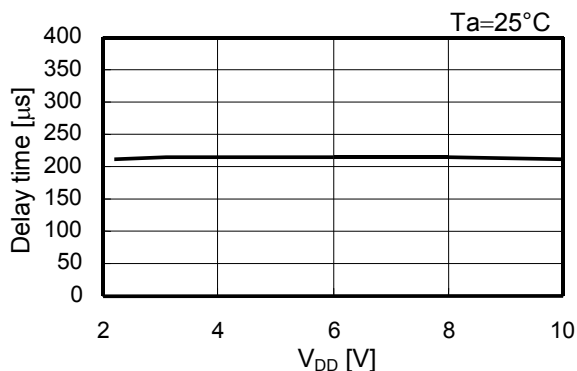
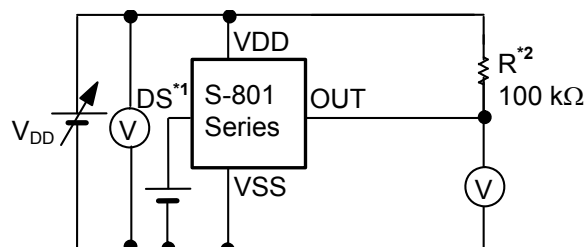

Figure 18 Measurement Condition for Delay Time



- \*1. Set to VDD or VSS.
- \*2. R is not necessary for CMOS output products.

Figure 19 Measurement Circuit for Delay Time

**Caution** The above connection diagram will not guarantees successful operation. Perform through using the actual application to set the constant.



16. Response Time - Load Capacitor (C<sub>OUT</sub>)

S-80122AL

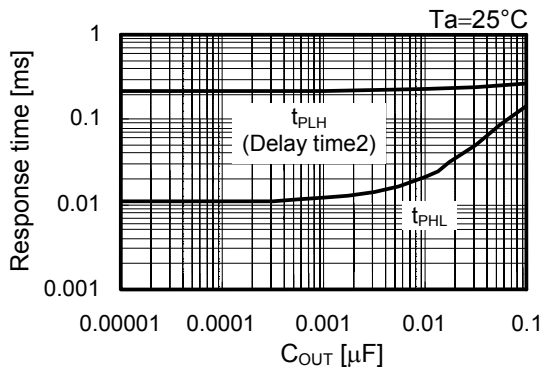

S-80122AN



S-80160AL

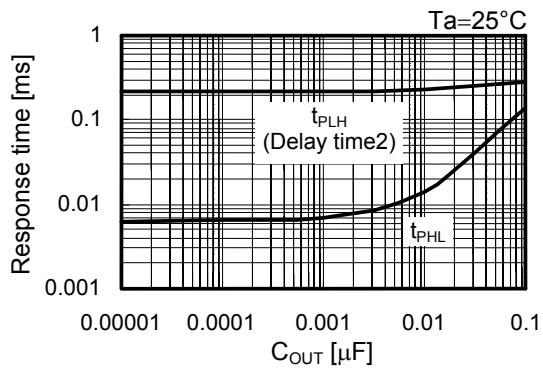

S-80160AN

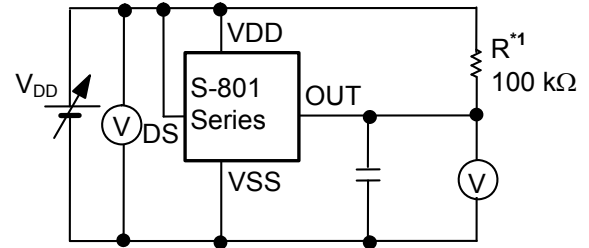

\*1. R is not necessary for CMOS output products.

Figure 20 Measurement Condition for Response Time

Figure 21 Measurement Circuit for Response Time

**Caution** The above connection diagram will not guarantees successful operation. Perform through using the actual application to set the constant.

■ Application Circuit Examples

Microcomputer Reset Circuits

If the power supply voltage to a microcomputer falls below the specified level, an unspecified operation may be performed or the contents of the memory register may be lost. When power supply voltage returns to normal, the microcomputer needs to be initialized before normal operations can be done. Reset circuits protect microcomputers in the event of current being momentarily switched off or lowered.

Reset circuits shown in **Figures 22 to 23** can be easily constructed with the help of the S-801 series that has low operating voltage, a high-precision detection voltage, hysteresis, and a built-in delay circuit.



Figure 22 Ret Circuit (S-801xxAL)



(Nch open-drain output products only.)

Figure 23 Reset Circuit (S-801xxAN)

**Caution** The above connection diagram will not guarantees successful operation. Perform through using the actual application to set the constant.



No. MP005-A-P-SD-1.3

TITLE	SOT235-A-PKG Dimensions
No.	MP005-A-P-SD-1.3
ANGLE	
UNIT	mm
<b>ABLIC Inc.</b>	



Feed direction →

No. MP005-A-C-SD-2.1

TITLE	SOT235-A-Carrier Tape
No.	MP005-A-C-SD-2.1
ANGLE	
UNIT	mm
<b>ABLIC Inc.</b>	



Enlarged drawing in the central part



No. MP005-A-R-SD-1.1

TITLE	SOT235-A-Reel		
No.	MP005-A-R-SD-1.1		
ANGLE		QTY.	3,000
UNIT	mm		
<b>ABLIC Inc.</b>			



No. PF004-A-P-SD-6.0

TITLE	SNT-4A-A-PKG Dimensions
No.	PF004-A-P-SD-6.0
ANGLE	
UNIT	mm
<b>ABLIC Inc.</b>	



No. PF004-A-C-SD-2.0

TITLE	SNT-4A-A-Carrier Tape
No.	PF004-A-C-SD-2.0
ANGLE	
UNIT	mm
<b>ABLIC Inc.</b>	



Enlarged drawing in the central part



No. PF004-A-R-SD-1.0

TITLE	SNT-4A-A-Reel		
No.	PF004-A-R-SD-1.0		
ANGLE		QTY.	5,000
UNIT	mm		
<b>ABLIC Inc.</b>			





※1. ランドパターンの幅に注意してください (0.25 mm min. / 0.30 mm typ.).

※2. パッケージ中央にランドパターンを広げないでください (1.10 mm ~ 1.20 mm)。

- 注意
1. パッケージのモールド樹脂下にシルク印刷やハンダ印刷などしないでください。
  2. パッケージ下の配線上のソルダーレジストなどの厚みをランドパターン表面から0.03 mm 以下にしてください。
  3. マスク開口サイズと開口位置はランドパターンと合わせてください。
  4. 詳細は "SNTパッケージ活用の手引き" を参照してください。

※1. Pay attention to the land pattern width (0.25 mm min. / 0.30 mm typ.).

※2. Do not widen the land pattern to the center of the package (1.10 mm to 1.20 mm).

**Caution 1. Do not do silkscreen printing and solder printing under the mold resin of the package.**

**2. The thickness of the solder resist on the wire pattern under the package should be 0.03 mm or less from the land pattern surface.**

**3. Match the mask aperture size and aperture position with the land pattern.**

**4. Refer to "SNT Package User's Guide" for details.**

※1. 请注意焊盘模式的宽度 (0.25 mm min. / 0.30 mm typ.).

※2. 请勿向封装中间扩展焊盘模式 (1.10 mm ~ 1.20 mm)。

注意 1. 请勿在树脂型封装的下面印刷丝网、焊锡。

2. 在封装下、布线上的阻焊膜厚度 (从焊盘模式表面起) 请控制在 0.03 mm 以下。

3. 钢网的开口尺寸和开口位置请与焊盘模式对齐。

4. 详细内容请参阅 "SNT 封装的应用指南"。

No. PF004-A-L-SD-4.1

TITLE	SNT-4A-A -Land Recommendation
No.	PF004-A-L-SD-4.1
ANGLE	
UNIT	mm
<b>ABLIC Inc.</b>	

## Disclaimers (Handling Precautions)

1. All the information described herein (product data, specifications, figures, tables, programs, algorithms and application circuit examples, etc.) is current as of publishing date of this document and is subject to change without notice.
2. The circuit examples and the usages described herein are for reference only, and do not guarantee the success of any specific mass-production design.  
ABLIC Inc. is not liable for any losses, damages, claims or demands caused by the reasons other than the products described herein (hereinafter "the products") or infringement of third-party intellectual property right and any other right due to the use of the information described herein.
3. ABLIC Inc. is not liable for any losses, damages, claims or demands caused by the incorrect information described herein.
4. Be careful to use the products within their ranges described herein. Pay special attention for use to the absolute maximum ratings, operation voltage range and electrical characteristics, etc.  
ABLIC Inc. is not liable for any losses, damages, claims or demands caused by failures and / or accidents, etc. due to the use of the products outside their specified ranges.
5. Before using the products, confirm their applications, and the laws and regulations of the region or country where they are used and verify suitability, safety and other factors for the intended use.
6. When exporting the products, comply with the Foreign Exchange and Foreign Trade Act and all other export-related laws, and follow the required procedures.
7. The products are strictly prohibited from using, providing or exporting for the purposes of the development of weapons of mass destruction or military use. ABLIC Inc. is not liable for any losses, damages, claims or demands caused by any provision or export to the person or entity who intends to develop, manufacture, use or store nuclear, biological or chemical weapons or missiles, or use any other military purposes.
8. The products are not designed to be used as part of any device or equipment that may affect the human body, human life, or assets (such as medical equipment, disaster prevention systems, security systems, combustion control systems, infrastructure control systems, vehicle equipment, traffic systems, in-vehicle equipment, aviation equipment, aerospace equipment, and nuclear-related equipment), excluding when specified for in-vehicle use or other uses by ABLIC, Inc. Do not apply the products to the above listed devices and equipments.  
ABLIC Inc. is not liable for any losses, damages, claims or demands caused by unauthorized or unspecified use of the products.
9. In general, semiconductor products may fail or malfunction with some probability. The user of the products should therefore take responsibility to give thorough consideration to safety design including redundancy, fire spread prevention measures, and malfunction prevention to prevent accidents causing injury or death, fires and social damage, etc. that may ensue from the products' failure or malfunction.  
The entire system in which the products are used must be sufficiently evaluated and judged whether the products are allowed to apply for the system on customer's own responsibility.
10. The products are not designed to be radiation-proof. The necessary radiation measures should be taken in the product design by the customer depending on the intended use.
11. The products do not affect human health under normal use. However, they contain chemical substances and heavy metals and should therefore not be put in the mouth. The fracture surfaces of wafers and chips may be sharp. Be careful when handling these with the bare hands to prevent injuries, etc.
12. When disposing of the products, comply with the laws and ordinances of the country or region where they are used.
13. The information described herein contains copyright information and know-how of ABLIC Inc. The information described herein does not convey any license under any intellectual property rights or any other rights belonging to ABLIC Inc. or a third party. Reproduction or copying of the information from this document or any part of this document described herein for the purpose of disclosing it to a third-party is strictly prohibited without the express permission of ABLIC Inc.
14. For more details on the information described herein or any other questions, please contact ABLIC Inc.'s sales representative.
15. This Disclaimers have been delivered in a text using the Japanese language, which text, despite any translations into the English language and the Chinese language, shall be controlling.

2.4-2019.07