

Serial EEPROM Series Standard EEPROM
SPI BUS EEPROM



BR25Sxxx-W Series (32K 64K 128K 256K)

● **General Description**

BR25Sxxx-W series is a serial EEPROM of SPI BUS interface method

● **Features**

- High speed clock action up to 20MHz (Max.)
- Wait function by HOLDB terminal
- Part or whole of memory arrays settable as read only memory area by program
- 1.7V to 5.5V single power source action most suitable for battery use
- Page write mode useful for initial value write at factory shipment
- Highly reliable connection by Au pad and Au wire
- For SPI bus interface (CPOL, CPHA) = (0, 0), (1, 1)
- Auto erase and auto end function at data rewrite
- Low current consumption
 - At write action (5V) : 1.5mA (Typ.)
 - At read action (5V) : 1.0mA (Typ.)
 - At standby action (5V) : 0.1μA (Typ.)
- Address auto increment function at read action
- Write mistake prevention function
 - Write prohibition at power on
 - Write prohibition by command code (WRDI)
 - Write prohibition by WP pin
 - Write prohibition block setting by status registers (BP1, BP0)
 - Write mistake prevention function at low voltage
- Data kept for 40 years
- Data rewrite up to 1,000,000 times
- Data at shipment
 - Memory array: FFh
 - Status register: WPEN, BP1, BP0 : 0

● **Packages W(Typ.) x D(Typ.) x H(Max.)**



● **Page write**

Page	32Byte	64Byte
Part Number	BR25S320-W BR25S640-W	BR25S128-W BR25S256-W

● **BR25Sxxx-W Series**

Capacity	Bit format	Power source voltage	SOP8	SOP-J8	SSOP-B8	TSSOP-B8	MSOP8	TSSOP-B8J	VSON008 X2030
32Kbit	4K × 8	1.7V to 5.5V	●	●	●	●	●	●	●
64Kbit	8K × 8	1.7V to 5.5V	●	●	●	●	●	●	
128Kbit	16K × 8	1.7V to 5.5V	●	●	●	●			
256Kbit	32K × 8	1.7V to 5.5V	●	●					

● Absolute Maximum Ratings (Ta=25°C)

Parameter	Symbol	Ratings	Unit	Remarks
Supply Voltage	V _{CC}	-0.3 to +6.5	V	
Power Dissipation	Pd	450 (SOP8)	mW	When using at Ta=25°C or higher 4.5mW to be reduced per 1°C.
		450 (SOP-J8)		When using at Ta=25°C or higher 4.5mW to be reduced per 1°C.
		300 (SSOP-B8)		When using at Ta=25°C or higher 3.0mW to be reduced per 1°C.
		330 (TSSOP-B8)		When using at Ta=25°C or higher 3.3mW to be reduced per 1°C.
		310 (TSSOP-B8J)		When using at Ta=25°C or higher 3.1mW to be reduced per 1°C.
		310 (MSOP8)		When using at Ta=25°C or higher 3.1mW to be reduced per 1°C.
		300 (VSON008X2030)		When using at Ta=25°C or higher 3.0mW to be reduced per 1°C.
Storage Temperature	T _{stg}	-65 to +125	°C	
Operating Temperature	T _{opr}	-40 to +85	°C	
Terminal Voltage	-	-0.3 to V _{CC} +0.3	V	

● Memory cell characteristics (Ta=25°C, V_{CC}=1.7V to 5.5V)

Parameter	Limits			Unit
	Min.	Typ.	Max.	
Number of data rewrite times *1	1,000,000	-	-	Times
Data hold years *1	40	-	-	Years

*1 Not 100% TESTED

● Recommended Operating Ratings

Parameter	Symbol	Ratings	Unit
Power source voltage	V _{CC}	1.7 to 5.5	V
Input voltage	V _{IN}	0 to V _{CC}	

● Input / output capacity (Ta=25°C, frequency=5MHz)

Parameter	Symbol	Min.	Max.	Unit	Conditions
Input capacity *1	C _{IN}	—	8	pF	V _{IN} =GND
Output capacity *1	C _{OUT}	—	8		V _{OUT} =GND

*1 Not 100% TESTED.

● Electrical characteristics (Unless otherwise specified, Ta=-40°C to +85°C, V_{CC}=1.7V to 5.5V)

Parameter	Symbol	Limits			Unit	Conditions
		Min.	Typ.	Max.		
"H" Input Voltage1	VIH1	0.7xV _{CC}	—	V _{CC} +0.3	V	1.7 ≤ V _{CC} ≤ 5.5V
"L" Input Voltage1	VIL1	-0.3	—	0.3xV _{CC}	V	1.7 ≤ V _{CC} ≤ 5.5V
"L" Output Voltage1	VOL1	0	—	0.4	V	IOL=2.1mA, 2.5 ≤ V _{CC} < 5.5V
"L" Output Voltage2	VOL2	0	—	0.2	V	IOL=1.0mA, 1.7 ≤ V _{CC} < 2.5V
"H" Output Voltage1	VOH1	V _{CC} -0.2	—	V _{CC}	V	IOH=-0.4mA, 2.5V ≤ V _{CC} < 5.5V
"H" Output Voltage2	VOH2	V _{CC} -0.2	—	V _{CC}	V	IOH=-100μA, 1.7 ≤ V _{CC} < 2.5V
Input Leakage Current	ILI	-1	—	1	μA	V _{IN} =0 to V _{CC}
Output Leakage Current	ILO	-1	—	1	μA	V _{OUT} =0 to V _{CC} , CSB=V _{CC}
Operating Current Write	ICC1	—	—	0.5 ^{*1}	mA	V _{CC} =1.8V, fSCK=5MHz, tE/W=5ms Byte Write, Page Write, Write Status register
				1 ^{*2}		
	ICC2	—	—	1 ^{*1}	mA	V _{CC} =2.5V, fSCK=10MHz, tE/W=5ms Byte Write, Page Write, Write Status register
			1.5 ^{*2}			
Operating Current Read	ICC3	—	—	2 ^{*1}	mA	V _{CC} =5.5V, fSCK=20MHz, tE/W=5ms Byte Write, Page Write, Write Status register
				3 ^{*2}		
	ICC4	—	—	1	mA	V _{CC} =1.8V, fSCK=5MHz, SO=OPEN Read, Read Status Register
	ICC5	—	—	1		
	ICC6	—	—	1.5	mA	V _{CC} =2.5V, fSCK=5MHz, SO=OPEN Read, Read Status Register
	ICC7	—	—	2		
	ICC8	—	—	2	mA	V _{CC} =5.5V, fSCK=5MHz, SO=OPEN Read, Read Status Register
ICC9	—	—	4			
ICC10	—	—	8	mA	V _{CC} =5.5V, fSCK=20MHz, SO=OPEN Read, Read Status Register	
Standby Current	ISB	—	—			2

*1 BR25S320/640-W

*2 BR25S128/256-W

● Operating timing characteristics (Ta=-40°C to +85°C, unless otherwise specified, load capacity CL=30pF)

Parameter	Symbol	1.7 ≤ Vcc < 2.5V			1.8 ≤ Vcc < 2.5V			2.5 ≤ Vcc < 4.5V			4.5 ≤ Vcc < 5.5V			Unit
		Min.	Typ.	Max.	Min.	Typ.	Max.	Min.	Typ.	Max.	Min.	Typ.	Max.	
SCK frequency	fSCK	-	-	3	-	-	5	-	-	10	-	-	20	MHz
SCK high time	tSCKWH	125	-	-	80	-	-	40	-	-	20	-	-	ns
SCK low time	tSCKWL	125	-	-	80	-	-	40	-	-	20	-	-	ns
CSB high time	tCS	250	-	-	90	-	-	40	-	-	20	-	-	ns
CSB setup time	tCSS	100	-	-	60	-	-	30	-	-	15	-	-	ns
CSB hold time	tCSH	100	-	-	60	-	-	30	-	-	15	-	-	ns
SCK setup time	tSCKS	100	-	-	50	-	-	20	-	-	15	-	-	ns
SCK hold time	tSCKH	100	-	-	50	-	-	20	-	-	15	-	-	ns
SI setup time	tDIS	30	-	-	20	-	-	10	-	-	5	-	-	ns
SI hold time	tDIH	50	-	-	20	-	-	10	-	-	5	-	-	ns
Data output delay time	tPD	-	-	125	-	-	80	-	-	40	-	-	20	ns
Output hold time	tOH	0	-	-	0	-	-	0	-	-	0	-	-	ns
Output disable time	tOZ	-	-	200	-	-	80	-	-	40	-	-	20	ns
HOLDB setting setup time	tHFS	100	-	-	0	-	-	0	-	-	0	-	-	ns
HOLDB setting hold time	tHFH	100	-	-	20	-	-	10	-	-	5	-	-	ns
HOLDB release setup time	tHRS	100	-	-	0	-	-	0	-	-	0	-	-	ns
HOLDB release hold time	tHRH	100	-	-	20	-	-	10	-	-	5	-	-	ns
Time from HOLDB to output High-Z	tHOZ	-	-	100	-	-	80	-	-	40	-	-	20	ns
Time from HOLDB to output change	tHPD	-	-	100	-	-	80	-	-	40	-	-	20	ns
SCK rise time	tRC	-	-	1	-	-	1	-	-	1	-	-	1	μs
SCK fall time	tFC	-	-	1	-	-	1	-	-	1	-	-	1	μs
OUTPUT rise time	tRO	-	-	100	-	-	50	-	-	40	-	-	20	ns
OUTPUT fall time	tFO	-	-	100	-	-	50	-	-	40	-	-	20	ns
Write time	tE/W	-	-	5	-	-	5	-	-	5	-	-	5	ms

*1 NOT 100% TESTED

● AC timing characteristics conditions

Parameter	Symbol	Limits			Unit
		Min.	Typ.	Max.	
Load capacity	CL	-	-	30	pF
Input rise time	-	-	-	50	ns
Input fall time	-	-	-	50	ns
Input voltage	-	0.2Vcc/0.8Vcc			V
Input / Output judgment voltage	-	0.3Vcc/0.7Vcc			V

● Sync data input / output timing

Figure 1. Input timing



Figure 2. Input / Output timing

SI is taken into IC inside in sync with data rise edge of SCK. Input address and data from the most significant bit MSB

SO is output in sync with data fall edge of SCK. Data is output from the most significant bit MSB.

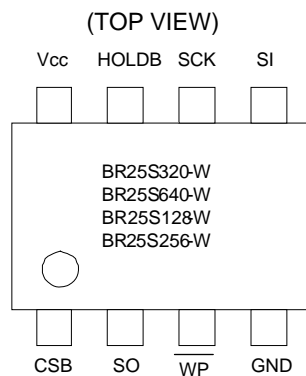

Figure 3. HOLD timing

●Block Diagram



●Pin Configuration



●Pin Descriptions

Terminal name	Input /Output	Function
Vcc	-	Power source to be connected
GND	-	All input / output reference voltage, 0V
CSB	Input	Chip select input
SCK	Input	Serial clock input
SI	Input	Start bit, ope code, address, and serial data input
SO	Output	Serial data output
HOLDB	Input	Hold input Command communications may be suspended temporarily (HOLD status)
WP	Input	Write protect input Write command is prohibited Write status register command is prohibited

● Typical Performance Curves

(The following characteristic data are Typ. Values.)



Figure 4. "H" Input Voltage V_{IH}
(CSB,SCK,SI,HOLDB,WP)

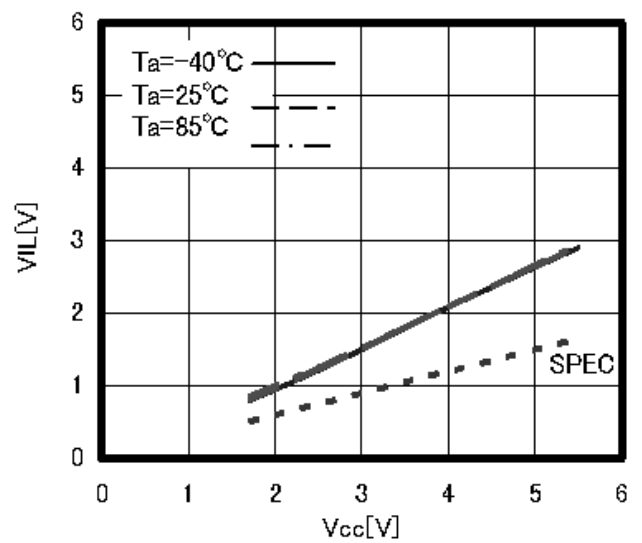

Figure 5. "L" Input Voltage V_{IL}
(CSB,SCK,SI,HOLDB,WP)



Figure 6. "L" Output Voltage V_{OL1} ($V_{cc}=2.5V$)



Figure 7. "H" Output Voltage V_{OH1}
($V_{cc}=2.5V$)

● Typical Performance Curves - Continued



Figure 8. Input Leak Current I_{LI}
(CSB,SCK,SI,HOLDB,WP)



Figure 9. Output Leak Current $I_{LO(SO)}$



Figure 10. Current consumption at WRITE operation $ICC3$
(BR25S320/640-W)



Figure 11. Current consumption at WRITE operation $ICC3$
(BR25S128/256-W)

● Typical Performance Curves - Continued



Figure 12. Current consumption at READ operation ICC10



Figure 13. Current consumption at standby operation ISB



Figure 14. SCK frequency fSCK



Figure 15. SCK high time tSCKWH

● Typical Performance Curves - Continued



Figure 16. SCK low time tSCKWL



Figure 17. CSB high time tCS

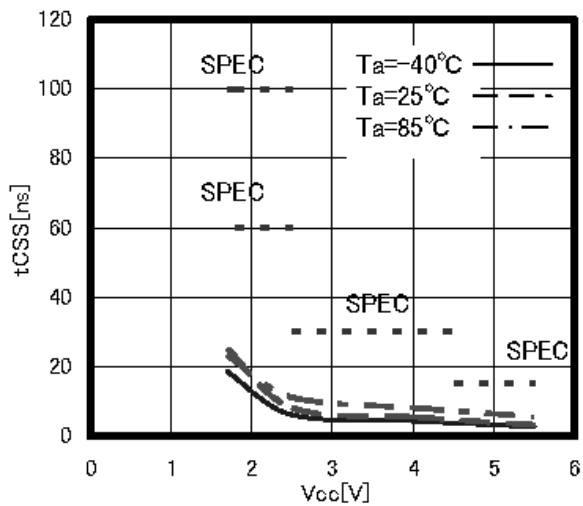

Figure 18. CSB setup time tCSS



Figure 19. CSB hold time tCSH

● Typical Performance Curves - Continued



Figure 20. SI setup time tDIS



Figure 21. SI hold time tDIH



Figure 22. Data output delay time tPD

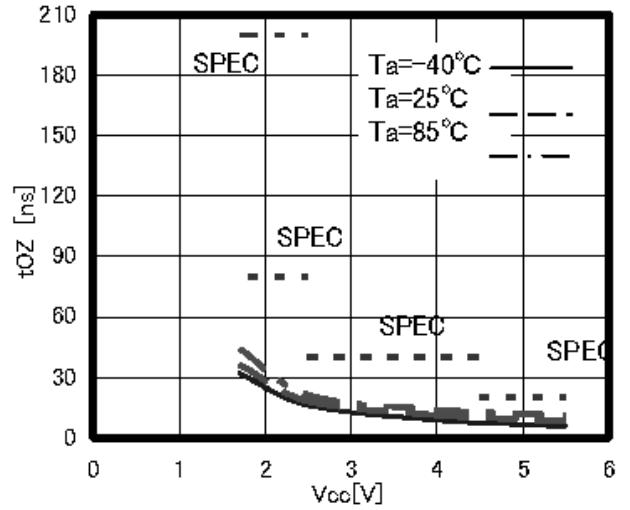

Figure 23. Output disable time tOZ

● Typical Performance Curves - Continued



Figure 24. HOLDB setting hold time tHFH



Figure 25. HOLDB release hold time tHRH



Figure 26. Time from HOLDB to output High-Z tHOZ



Figure 27. Time from HOLDB to output change tHPD

● Typical Performance Curves - Continued



Figure 28. Output rise time tRO



Figure 29. Output fall time tFO



Figure 30. Write cycle time tE/W

●Features

○Status registers

This IC has status register. The status register expresses the following parameters of 8 bits.

BP0 and BP1 can be set by write status register command. These 2 bits are memorized into the EEPROM, therefore are valid even when power source is turned off.

Rewrite characteristics and data hold time are same as characteristics of the EEPROM.

WEN can be set by write enable command and write disable command. WEN becomes write disable status when power source is turned off. R/B is for write confirmation, therefore cannot be set externally.

The value of status register can be read by read status register command.

1. Contexture of status register

Product number	bit 7	bit 6	bit 5	bit 4	bit 3	bit 2	bit 1	bit 0
BR25S320-W	WPEN	0	0	0	BP1	BP0	WEN	\bar{R}/B
BR25S640-W								
BR25S128-W								
BR25S256-W								

bit	Memory location	Function
WPEN	EEPROM	WP pin enable / disable designation bit WPEN=0=invalid WPEN=1=valid
BP1 BP0	EEPROM	EEPROM write disable block designation bit
WEN	registers	Write and write status register write enable / disable status confirmation bit WEN=0=prohibited WEN=1=permitted
\bar{R}/B	registers	Write cycle status (READY / BUSY) status confirmation bit $\bar{R}/B=0=READY$ $\bar{R}/B=1=BUSY$

2. Write disable block setting

BP1	BP0	Write disable block			
		BR25S320-W	BR25S640-W	BR25S128-W	BR25S256-W
0	0	None	None	None	None
0	1	C00h-FFFh	1800h-1FFFh	3000h-3FFFh	6000h-7FFFh
1	0	800h-FFFh	1000h-1FFFh	2000h-3FFFh	4000h-7FFFh
1	1	000h-FFFh	0000h-1FFFh	0000h-3FFFh	0000h-7FFFh

○OWP pin

By setting WP=LOW, write command is prohibited. And the write command to be disabled at this moment is WRSR. However, when write cycle is in execution, no interruption can be made.

Product number	WRSR	WRITE
BR25S320-W	Prohibition possible but WPEN bit "1"	Prohibition impossible
BR25S640-W		
BR25S128-W		
BR25S256-W		

○HOLDB pin

By HOLDB pin, data transfer can be interrupted. When SCK="0", by making HOLDB from "1" into "0", data transfer to EEPROM is interrupted. When SCK = "0", by making HOLDB from "0" into "1", data transfer is restarted.

●Command mode

Command	Contents	Ope code	
WREN	Write enable command	0000	0110
WRDI	Write disable command	0000	0100
READ	Read command	0000	0011
WRITE	Write command	0000	0010
RDSR	Read status register command	0000	0101
WRSR	Write status register command	0000	0001

●Timing chart

1. Write enable (WREN) / disable (WRDI) command



Figure 31. Write enable command



Figure 32. Write disable command

This IC has write enable status and write disable status. It is set to write enable status by write enable command, and it is set to write disable status by write disable command. As for these commands, set CSB LOW, and then input the respective commands. The respective commands are accepted at the 7-th clock rise. Even with input over 7 clocks, command becomes valid.

When to carry out write command, it is necessary to set write enable status by the write enable command. If write command is input in the write disable status, the command is cancelled. And even in the write enable status, once write command is executed, it gets in the write disable status. After power on, this IC is in write disable status.

2. Read command (READ)



Figure 33. Read command

Product number	Address length
BR25S320-W	A11-A0
BR25S640-W	A12-A0
BR25S128-W	A13-A0
BR25S256-W	A14-A0

By read command, data of EEPROM can be read. As for this command, set CSB LOW, then input address after read ope code. EEPROM starts data output of the designated address. Data output is started from SCK fall of 23-th clock, and from D7 to D0 sequentially. This IC has increment read function. After output of data for 1 byte (8bits), by continuing input of SCK, data of the next address can be read. Increment read can read all the addresses of EEPROM. After reading data of the most significant address, by continuing increment read, data of the most insignificant address is read.

3. Write command (WRITE)



Product number	Address length
BR25S320-W	A11-A0
BR25S640-W	A12-A0
BR25S128-W	A13-A0
BR25S256-W	A14-A0

Figure 34. Write command

By write command, data of EEPROM can be written. As for this command, set CSB LOW, then input address and data after write ope code. Then, by making CSB HIGH, the EEPROM starts writing. The write time of EEPROM requires time of tE/W (Max 5ms). During tE/W, other than read status register command is not accepted. Set CSB HIGH between taking the last data (D0) and rising the next SCK clock. At the other timing, write command is not executed, and this write command is cancelled. This IC has page write function, and after input of data for 1 byte (8 bits), by continuing data input without setting CSB HIGH, 2byte or more data can be written for one tE/W. The maximum number of write bytes is specified per device of each capacity. Up to 64 arbitrary bytes can be written (in the case of BR25S128/256-W). In page write, the insignificant 5 bit of the designated address is incremented internally at every time when data of 1 byte is input and data is written to respective addresses. When data of the maximum bytes or higher is input, address rolls over, and previously input data is overwritten.

4. Write status register, Read status register command (WRSR/RDSR)



Figure 35. Write status register

Write status register command can write data of status register. The data can be written by this command are 3 bits, that is, WPEN(bit7), BP1 (bit3) and BP0 (bit2) among 8 bits of status register. By BP1 and BP0, write disable block of EEPROM can be set. As for this command, set CSB LOW, and input ope code of write status register, and input data. Then, by making CSB HIGH, EEPROM starts writing. Write time requires time of tE/W as same as write. As for CSB rise, set CSB HIGH between taking the last data bit (bit0) and the next SCK clock rising. At the other timing, command is cancelled. Write disable block is determined by BP1 BP0, and the block can be selected from 1/4 , 1/2, and entire of memory array (Refer to the write disable block setting table.). To the write disabled block, write cannot be made, and only read can be made.

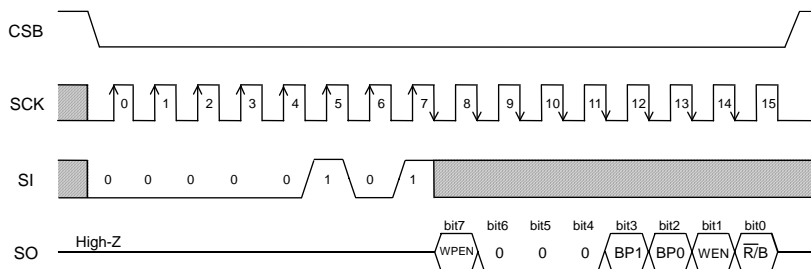

Figure 36. Read status register command

● \overline{WP} cancel valid area

\overline{WP} is normally fixed to "H" or "L" for use, but when \overline{WP} is controlled so as to cancel write status register command, pay attention to the following \overline{WP} valid timing.

While write status register command is executed, by setting $\overline{WP} = "L"$ in cancel valid area, command can be cancelled. The area from command ope code to CSB rise at internal automatic write start becomes the cancel valid area. However, once write is started, by any input write cycle cannot be cancelled. \overline{WP} input becomes Don't Care, and cancellation becomes invalid.



Figure 37. \overline{WP} valid timing (At inputting WRSR command)

● HOLDB pin

By HOLDB pin, command communication can be stopped temporarily (HOLD status). The command communications are carried out when the HOLDB pin is HIGH. To get in HOLD status, at command communication, when SCK=LOW, set the HOLDB pin LOW. At HOLD status, SCK and SI become Don't Care, and SO becomes high impedance (High-Z). To release the HOLD status, set the HOLDB pin HIGH when SCK=LOW. After that, communication can be restarted from the point before the HOLD status. For example, when HOLD status is made after A5 address input at read, after release of HOLD status, by starting A4 address input, read can be restarted. When in HOLD status, keep CSB LOW. When it is set CSB=HIGH in HOLD status, the IC is reset, therefore communication after that cannot be restarted.

●Method to cancel each command

OREAD, RDSR

- Method to cancel : cancel by CSB = "H".



Figure 38. READ cancel valid timing



Figure 39. RDSR cancel valid timing

OWRITE, PAGE WRITE

- a : Ope code or address input area
Cancellation is available by CSB="H".
- b : Data input area (D7 to D1 input area)
Cancellation is available by CSB="H".
- c : Data input area (D0 area)
In this area, cancellation is not available.
When CSB is set HIGH, write starts.
- d : tE/W area
In the area c, by rising CSB, write starts.
While writing, by any input, cancellation cannot be made.



Figure 40. WRITE cancel valid timing

Note1) If Vcc is made OFF during write execution, designated address data is not guaranteed, therefore write it once again.
 Note2) If CSB is risen at the same timing as that of the SCK rise, write execution / cancel becomes unstable, therefore, it is recommended to rise in SCK = "L" area. As for SCK rise, assure timing of tCSS / tCSH or more.

OWRSR

- a : From ope code to 15-th clock rise
Cancellation is available by CSB="H".
- b : From 15-th clock rise to 16-th clock rise (write enable area)
In this area, cancellation is not available.
When CSB is set HIGH, write starts.
- c : After 16-th clock rise.
Cancellation is available by CSB="H".
However, if write starts (CSB is risen) in the area b, cancellation cannot be made by any means.
And, by inputting on SCK clock, cancellation cannot be made.



Figure 41. WRSR cancel valid timing

Note1) If Vcc is made OFF during write execution, designated address data is not guaranteed, therefore write it once again

Note2) If CSB is risen at the same timing as that of the SCK rise, write execution / cancel becomes unstable, therefore, it is recommended to rise in SCK = "L" area. As for SCK rise, assure timing of tCSS / tCSH or more.

OWREN/WRDI

- a : From ope code to 7-th clock rise, cancellation is available by CSB = "H".
- b : Cancellation is not available 7-th clock.

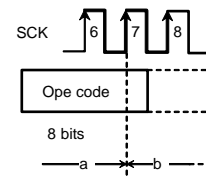

Figure 42. WREN/WRDI cancel valid timing

● I/O peripheral circuits

In order to realize stable high speed operations, pay attention to the following input / output pin conditions.

○ Input pin pull up, pull down resistance

When to attach pull up, pull down resistance to EEPROM input pin, select an appropriate value for the microcontroller VOLM, IOL with considering VIL characteristics of this IC.

1. Pull up resistance



Figure 43. Pull up resistance

$$R_{PU} \geq \frac{V_{CC} - V_{OLM}}{I_{OLM}} \quad \dots \textcircled{1}$$

$$V_{OLM} \leq V_{ILE} \quad \dots \textcircled{2}$$

Example) When $V_{CC}=5V$, $V_{ILE}=1.5V$, $V_{OLM}=0.4V$, $I_{OLM}=2mA$, from the equation ①,

$$R_{PU} \geq \frac{5 - 0.4}{2 \times 10^{-3}}$$

$$\therefore R_{PU} \geq 2.3[k\Omega]$$

With the value of R_{PU} to satisfy the above equation, V_{OLM} becomes 0.4V or lower, and with $V_{ILE}(=1.5V)$, the equation ② is also satisfied.

- V_{ILE} :EEPROM V_{IL} specifications
- V_{OLM} :Microcontroller V_{OL} specifications
- I_{OLM} :Microcontroller I_{OL} specifications

And, in order to prevent malfunction or erroneous write at power ON/OFF, be sure to make CSB pull up.

2. Pull down resistance

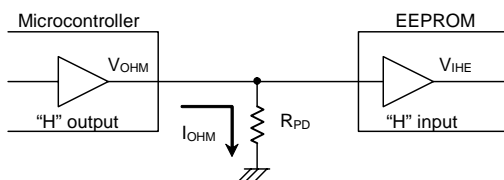

Figure 44. Pull down resistance

$$R_{PD} \geq \frac{V_{OHM}}{I_{OHM}} \quad \dots \textcircled{3}$$

$$V_{OHM} \geq V_{IHE} \quad \dots \textcircled{4}$$

Example) When $V_{CC}=5V$, $V_{OHM}=V_{CC}-0.5V$, $I_{OHM}=0.4mA$, $V_{IHE}=V_{CC} \times 0.7V$, from the equation ③,

$$R_{PD} \geq \frac{5 - 0.5}{0.4 \times 10^{-3}}$$

$$\therefore R_{PD} \geq 11.3[k\Omega]$$

Further, by amplitude V_{IHE} , V_{ILE} of signal input to EEPROM, operation speed changes. By inputting V_{CC}/GND level amplitude of signal, more stable high speed operations can be realized. On the contrary, when amplitude of $0.8V_{CC}$ / $0.2V_{CC}$ is input, operation speed becomes slow.¹

In order to realize more stable high speed operation, it is recommended to make the values of R_{PU} , R_{PD} as large as possible, and make the amplitude of signal input to EEPROM close to the amplitude of V_{CC} / GND level.

(¹ In this case, guaranteed value of operating timing is guaranteed.)

○ SO load capacity condition

Load capacity of SO output pin affects upon delay characteristic of SO output (Data output delay time, time from HOLDB to High-Z, Output rise time, Output fall time.). In order to make output delay characteristic into better, make SO load capacity small.



Figure 45. SO load capacity

○ Other cautions

Make the each wire length from the microcontroller to EEPROM input pin same length, in order to prevent setup / hold violation to EEPROM, owing to difference of wire length of each input.

●Equivalent circuit

○Output circuit



Figure 46. SO output equivalent circuit

○Input circuit



Figure 47. CSB input equivalent circuit



Figure 48. SCK input equivalent circuit

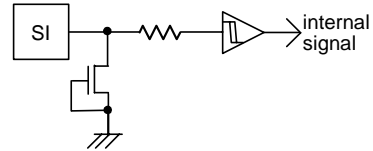

Figure 49. SI input equivalent circuit

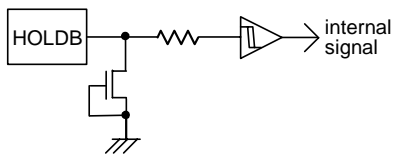

Figure 50. HOLDB input equivalent circuit

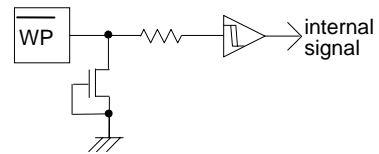

Figure 51. \overline{WP} input equivalent circuit

●Notes on power ON/OFF

○At standby

Set CSB "H", and be sure to set SCK, SI input "L" or "H". Do not input intermediate electric potential.

○At power ON/OFF

When Vcc rise or fall, set CSB="H" (=Vcc).

When CSB is "L", this IC gets in input accept status (active). If power is turned on in this status, noises and the likes may cause malfunction, erroneous write or so. To prevent these, at power ON, set CSB "H". (When CSB is in "H" status, all inputs are canceled.)



Figure 52. CSB timing at power ON/OFF

(Good example) CSB terminal is pulled up to Vcc.

At power OFF, take 10ms or more before supply. If power is turned on without observing this condition, the IC internal circuit may not be reset.

(Bad example) CSB terminal is "L" at power ON/OFF.

In this case, CSB always becomes "L" (active status), and EEPROM may have malfunction or erroneous write owing to noises and the likes.

Even when CSB input is High-Z, the status becomes like this case.

○Operating timing after power ON

As shown in Figure 53, at standby, when SCK is "H", even if CSB is fallen, SI status is not read at fall edge. SI status is read at SCK rise edge after fall of CSB. At standby and at power ON/OFF, set CSB "H" status.



Figure 53. Operating timing

○At power on malfunction preventing function

This IC has a POR (Power On Reset) circuit as mistake write countermeasure. After POR action, it gets in write disable status. The POR circuit is valid only when power is ON, and does not work when power is OFF. When power is ON, if the recommended conditions of the following t_R , t_{OFF} , and V_{bot} are not satisfied, it may become write enable status owing to noises and the likes.

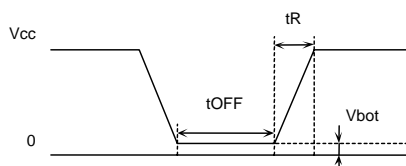

Figure 54. Rise waveform

Recommended conditions of t_R , t_{OFF} , V_{bot}

t_R	t_{OFF}	V_{bot}
10ms or below	10ms or higher	0.3V or below
100ms or below	10ms or higher	0.2V or below

○Low voltage malfunction preventing function

LVCC (Vcc-Lockout) circuit prevents data rewrite action at low power, and prevents wrong write.

At LVCC voltage (Typ. =1.2V) or below, it prevent data rewrite.

●Noise countermeasures

○Vcc noise (bypass capacitor)

When noise or surge gets in the power source line, malfunction may occur, therefore, for removing these, it is recommended to attach a bypass capacitor (0.1μF) between IC Vcc and GND. At that time, attach it as close to IC as possible.

And, it is also recommended to attach a bypass capacitor between board Vcc and GND.

○SCK noise

When the rise time of SCK (t_{RC}) is long, and a certain degree or more of noise exists, malfunction may occur owing to clock bit displacement. To avoid this, a Schmitt trigger circuit is built in SCK input. The hysteresis width of this circuit is set about 0.2V, if noises exist at SCK input, set the noise amplitude 0.2V_{p-p} or below. And it is recommended to set the rise time of SCK (t_{RC}) 100ns or below. In the case when the rise time is 100ns or higher, take sufficient noise countermeasures. Make the clock rise, fall time as small as possible.

○OWP noise

During execution of write status register command, if there exist noises on WP pin, mistake in recognition may occur and forcible cancellation may result. To avoid this, a Schmitt trigger circuit is built in WP input. In the same manner, a Schmitt trigger circuit is built in CSB input, SI input and HOLDB input too.

●Notes for use

- (1) Described numeric values and data are design representative values, and the values are not guaranteed.
- (2) We believe that application circuit examples are recommendable, however, in actual use, confirm characteristics further sufficiently. In the case of use by changing the fixed number of external parts, make your decision with sufficient margin in consideration of static characteristics and transition characteristics and fluctuations of external parts and our LSI.
- (3) Absolute maximum ratings
If the absolute maximum ratings such as impressed voltage and operating temperature range and so forth are exceeded, LSI may be destructed. Do not impress voltage and temperature exceeding the absolute maximum ratings. In the case of fear exceeding the absolute maximum ratings, take physical safety countermeasures such as fuses, and see to it that conditions exceeding the absolute maximum ratings should not be impressed to LSI.
- (4) GND electric potential
Set the voltage of GND terminal lowest at any action condition. Make sure that each terminal voltage is higher than that of GND terminal.
- (5) Heat design
In consideration of permissible dissipation in actual use condition, carry out heat design with sufficient margin.
- (6) Terminal to terminal short circuit and wrong packaging
When to package LSI onto a board, pay sufficient attention to LSI direction and displacement. Wrong packaging may destruct LSI. And in the case of short circuit between LSI terminals and terminals and power source, terminal and GND owing to foreign matter, LSI may be destructed.
- (7) Use in a strong electromagnetic field may cause malfunction, therefore, evaluate design sufficiently.

Status of this document

The Japanese version of this document is formal specification. A customer may use this translation version only for a reference to help reading the formal version.

If there are any differences in translation version of this document formal version takes priority.

● Ordering Information

Product Code Description

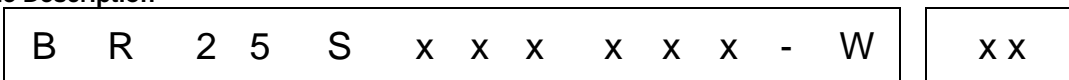

BUS type

25 : SPI

Operating temperature

-40°C to+85°C

Capacity

32=32K 256=256K

64=64K

128=128K

Package

F :SOP8

FJ :SOP-J8

FV :SSOP-B8

FVT :TSSOP-B8

FVJ :TSSOP-B8J

FVM :MSOP8

NUX :VSON008X2030

Double Cell

Packaging and forming specification

E2 : Embossed tape and reel (SOP8,SOP-J8, SSOP-B8,TSSOP-B8, TSSOP-B8J)

TR : Embossed tape and reel (MSOP8, VSON008X2030)

● Lineup

Capacity	Package	
	Type	Quantity
32K	SOP8	Reel of 2500
	SOP-J8	
	SSOP-B8	
	TSSOP-B8	Reel of 3000
	TSSOP-B8J	Reel of 2500
	MSOP8	Reel of 3000
	VSON008X2030	Reel of 4000
64K	SOP8	Reel of 2500
	SOP-J8	
	SSOP-B8	
	TSSOP-B8	Reel of 3000
	TSSOP-B8J	Reel of 2500
	MSOP8	Reel of 3000
128K	SOP8	Reel of 2500
	SOP-J8	
	SSOP-B8	
	TSSOP-B8	Reel of 3000
256K	SOP8	Reel of 2500
	SOP-J8	

●Physical Dimension Tape and Reel Information - continued

SOP-J8



●Physical Dimension Tape and Reel Information - continued

SSOP-B8

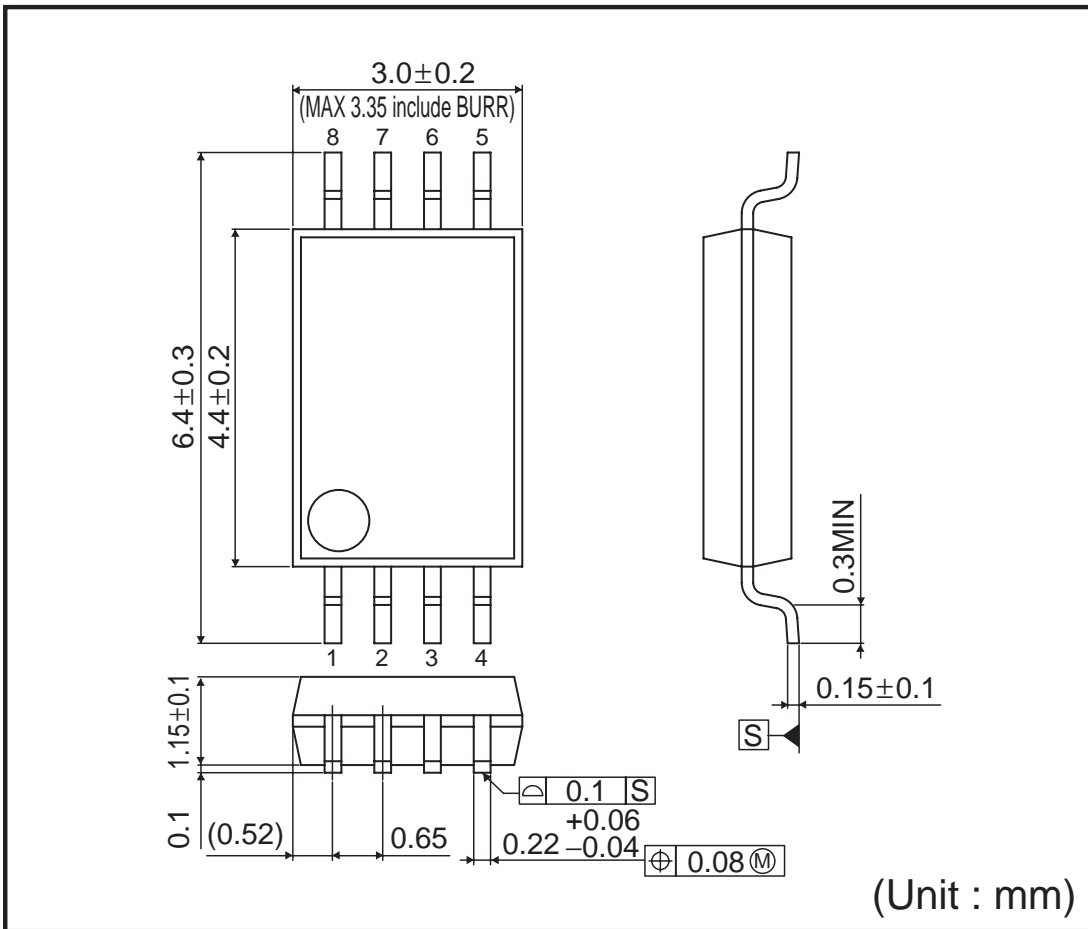

<Tape and Reel information>

Tape	Embossed carrier tape
Quantity	2500pcs
Direction of feed	E2 (The direction is the 1pin of product is at the upper left when you hold reel on the left hand and you pull out the tape on the right hand)

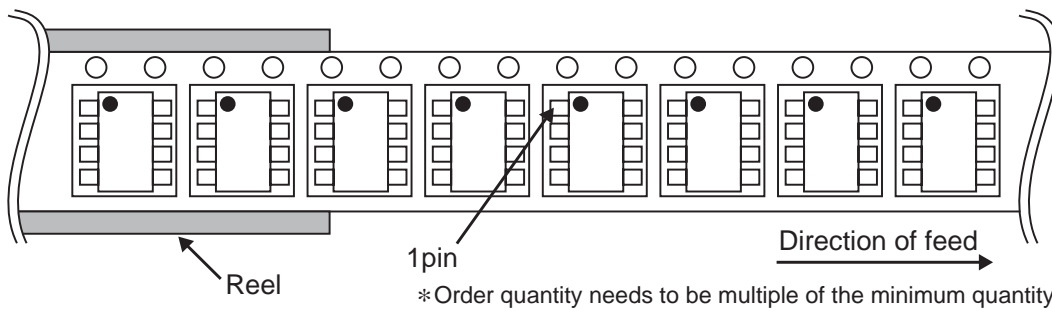

●Physical Dimension Tape and Reel Information - continued

TSSOP-B8



<Tape and Reel information>

Tape	Embossed carrier tape
Quantity	3000pcs
Direction of feed	E2 (The direction is the 1pin of product is at the upper left when you hold reel on the left hand and you pull out the tape on the right hand)



●Physical Dimension Tape and Reel Information - continued

TSSOP-B8J



<Tape and Reel information>

Tape	Embossed carrier tape
Quantity	2500pcs
Direction of feed	E2 (The direction is the 1pin of product is at the upper left when you hold reel on the left hand and you pull out the tape on the right hand)

Diagram of an embossed carrier tape showing the direction of feed and the location of the 1pin mark. The tape is shown with a "Reel" on the left and "Direction of feed" indicated by an arrow pointing right. A "1pin" mark is shown on the tape.

*Order quantity needs to be multiple of the minimum quantity.

●Physical Dimension Tape and Reel Information - continued

MSOP8



<Tape and Reel information>

Tape	Embossed carrier tape
Quantity	3000pcs
Direction of feed	TR (The direction is the 1pin of product is at the upper right when you hold reel on the left hand and you pull out the tape on the right hand)

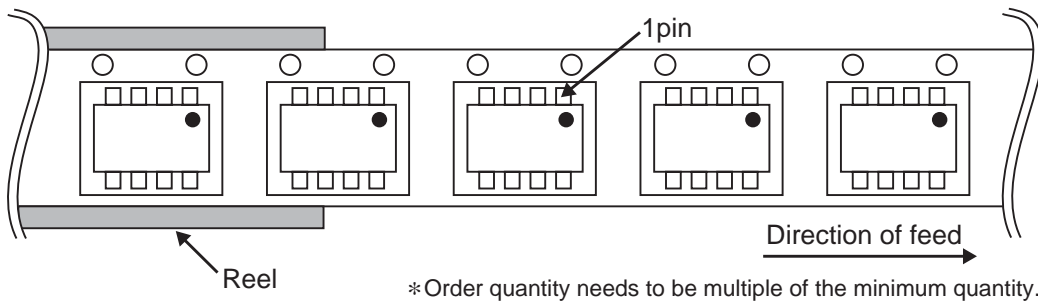

●Physical Dimension Tape and Reel Information - continued

VSON008X2030



<Tape and Reel information>

Tape	Embossed carrier tape
Quantity	4000pcs
Direction of feed	TR (The direction is the 1pin of product is at the upper right when you hold reel on the left hand and you pull out the tape on the right hand)



● Marking Diagrams



● Marking Information

Capacity	Product Name Marking	Package Type
32K	S320	SOP8
	S320	SOP-J8
	S320	SSOP-B8
	S320	TSSOP-B8
	S320	TSSOP-B8J
	S320	MSOP8
	S320	VSON008X2030
64K	S640	SOP8
	S640	SOP-J8
	S640	SSOP-B8
	S640	TSSOP-B8
	S640	TSSOP-B8J
	S640	MSOP8
128K	5S128	SOP8
	5S128	SOP-J8
	S128	SSOP-B8
	5S128	TSSOP-B8
256K	5S256	SOP8
	5S256	SOP-J8

●Revision History

Date	Revision	Changes
21.Aug.2012	001	New Release

Notice

Precaution on using ROHM Products

- Our Products are designed and manufactured for application in ordinary electronic equipments (such as AV equipment, OA equipment, telecommunication equipment, home electronic appliances, amusement equipment, etc.). If you intend to use our Products in devices requiring extremely high reliability (such as medical equipment ^(Note 1), transport equipment, traffic equipment, aircraft/spacecraft, nuclear power controllers, fuel controllers, car equipment including car accessories, safety devices, etc.) and whose malfunction or failure may cause loss of human life, bodily injury or serious damage to property ("Specific Applications"), please consult with the ROHM sales representative in advance. Unless otherwise agreed in writing by ROHM in advance, ROHM shall not be in any way responsible or liable for any damages, expenses or losses incurred by you or third parties arising from the use of any ROHM's Products for Specific Applications.

(Note1) Medical Equipment Classification of the Specific Applications

JAPAN	USA	EU	CHINA
CLASS III	CLASS III	CLASS II b	CLASS III
CLASS IV		CLASS III	

- ROHM designs and manufactures its Products subject to strict quality control system. However, semiconductor products can fail or malfunction at a certain rate. Please be sure to implement, at your own responsibilities, adequate safety measures including but not limited to fail-safe design against the physical injury, damage to any property, which a failure or malfunction of our Products may cause. The following are examples of safety measures:
 - Installation of protection circuits or other protective devices to improve system safety
 - Installation of redundant circuits to reduce the impact of single or multiple circuit failure
- Our Products are designed and manufactured for use under standard conditions and not under any special or extraordinary environments or conditions, as exemplified below. Accordingly, ROHM shall not be in any way responsible or liable for any damages, expenses or losses arising from the use of any ROHM's Products under any special or extraordinary environments or conditions. If you intend to use our Products under any special or extraordinary environments or conditions (as exemplified below), your independent verification and confirmation of product performance, reliability, etc. prior to use, must be necessary:
 - Use of our Products in any types of liquid, including water, oils, chemicals, and organic solvents
 - Use of our Products outdoors or in places where the Products are exposed to direct sunlight or dust
 - Use of our Products in places where the Products are exposed to sea wind or corrosive gases, including Cl₂, H₂S, NH₃, SO₂, and NO₂
 - Use of our Products in places where the Products are exposed to static electricity or electromagnetic waves
 - Use of our Products in proximity to heat-producing components, plastic cords, or other flammable items
 - Sealing or coating our Products with resin or other coating materials
 - Use of our Products without cleaning residue of flux (even if you use no-clean type fluxes, cleaning residue of flux is recommended); or Washing our Products by using water or water-soluble cleaning agents for cleaning residue after soldering
 - Use of the Products in places subject to dew condensation
- The Products are not subject to radiation-proof design.
- Please verify and confirm characteristics of the final or mounted products in using the Products.
- In particular, if a transient load (a large amount of load applied in a short period of time, such as pulse. is applied, confirmation of performance characteristics after on-board mounting is strongly recommended. Avoid applying power exceeding normal rated power; exceeding the power rating under steady-state loading condition may negatively affect product performance and reliability.
- De-rate Power Dissipation (Pd) depending on Ambient temperature (Ta). When used in sealed area, confirm the actual ambient temperature.
- Confirm that operation temperature is within the specified range described in the product specification.
- ROHM shall not be in any way responsible or liable for failure induced under deviant condition from what is defined in this document.

Precaution for Mounting / Circuit board design

- When a highly active halogenous (chlorine, bromine, etc.) flux is used, the residue of flux may negatively affect product performance and reliability.
- In principle, the reflow soldering method must be used; if flow soldering method is preferred, please consult with the ROHM representative in advance.

For details, please refer to ROHM Mounting specification

Precautions Regarding Application Examples and External Circuits

1. If change is made to the constant of an external circuit, please allow a sufficient margin considering variations of the characteristics of the Products and external components, including transient characteristics, as well as static characteristics.
2. You agree that application notes, reference designs, and associated data and information contained in this document are presented only as guidance for Products use. Therefore, in case you use such information, you are solely responsible for it and you must exercise your own independent verification and judgment in the use of such information contained in this document. ROHM shall not be in any way responsible or liable for any damages, expenses or losses incurred by you or third parties arising from the use of such information.

Precaution for Electrostatic

This Product is electrostatic sensitive product, which may be damaged due to electrostatic discharge. Please take proper caution in your manufacturing process and storage so that voltage exceeding the Products maximum rating will not be applied to Products. Please take special care under dry condition (e.g. Grounding of human body / equipment / solder iron, isolation from charged objects, setting of Ionizer, friction prevention and temperature / humidity control).

Precaution for Storage / Transportation

1. Product performance and soldered connections may deteriorate if the Products are stored in the places where:
 - [a] the Products are exposed to sea winds or corrosive gases, including Cl₂, H₂S, NH₃, SO₂, and NO₂
 - [b] the temperature or humidity exceeds those recommended by ROHM
 - [c] the Products are exposed to direct sunshine or condensation
 - [d] the Products are exposed to high Electrostatic
2. Even under ROHM recommended storage condition, solderability of products out of recommended storage time period may be degraded. It is strongly recommended to confirm solderability before using Products of which storage time is exceeding the recommended storage time period.
3. Store / transport cartons in the correct direction, which is indicated on a carton with a symbol. Otherwise bent leads may occur due to excessive stress applied when dropping of a carton.
4. Use Products within the specified time after opening a humidity barrier bag. Baking is required before using Products of which storage time is exceeding the recommended storage time period.

Precaution for Product Label

QR code printed on ROHM Products label is for ROHM's internal use only.

Precaution for Disposition

When disposing Products please dispose them properly using an authorized industry waste company.

Precaution for Foreign Exchange and Foreign Trade act

Since our Products might fall under controlled goods prescribed by the applicable foreign exchange and foreign trade act, please consult with ROHM representative in case of export.

Precaution Regarding Intellectual Property Rights

1. All information and data including but not limited to application example contained in this document is for reference only. ROHM does not warrant that foregoing information or data will not infringe any intellectual property rights or any other rights of any third party regarding such information or data. ROHM shall not be in any way responsible or liable for infringement of any intellectual property rights or other damages arising from use of such information or data.:
2. No license, expressly or implied, is granted hereby under any intellectual property rights or other rights of ROHM or any third parties with respect to the information contained in this document.

Other Precaution

1. This document may not be reprinted or reproduced, in whole or in part, without prior written consent of ROHM.
2. The Products may not be disassembled, converted, modified, reproduced or otherwise changed without prior written consent of ROHM.
3. In no event shall you use in any way whatsoever the Products and the related technical information contained in the Products or this document for any military purposes, including but not limited to, the development of mass-destruction weapons.
4. The proper names of companies or products described in this document are trademarks or registered trademarks of ROHM, its affiliated companies or third parties.

General Precaution

1. Before you use our Products, you are requested to carefully read this document and fully understand its contents. ROHM shall not be in any way responsible or liable for failure, malfunction or accident arising from the use of any ROHM's Products against warning, caution or note contained in this document.
2. All information contained in this document is current as of the issuing date and subject to change without any prior notice. Before purchasing or using ROHM's Products, please confirm the latest information with a ROHM sales representative.
3. The information contained in this document is provided on an "as is" basis and ROHM does not warrant that all information contained in this document is accurate and/or error-free. ROHM shall not be in any way responsible or liable for any damages, expenses or losses incurred by you or third parties resulting from inaccuracy or errors of or concerning such information.