

SAM D20E / SAM D20G / SAM D20J Summary

DATASHEET SUMMARY

Introduction

Atmel® | SMART™ SAM D20 is a series of low-power microcontrollers using the 32-bit ARM® Cortex®-M0+ processor, and ranging from 32- to 64-pins with up to 256KB Flash and 32KB of SRAM. The SAM D20 devices operate at a maximum frequency of 48MHz and reach 2.46 CoreMark®/MHz. They are designed for simple and intuitive migration with identical peripheral modules, hex compatible code, identical linear address map and pin compatible migration paths between all devices in the product series. All devices include intelligent and flexible peripherals, Atmel Event System for inter-peripheral signaling, and support for capacitive touch button, slider and wheel user interfaces.

Features

- Processor
 - ARM Cortex-M0+ CPU running at up to 48MHz
 - Single-cycle hardware multiplier
- Memories
 - 16/32/64/128/256KB in-system self-programmable Flash
 - 2/4/8/16/32KB SRAM Memory
- System
 - Power-on reset (POR) and brown-out detection (BOD)
 - Internal and external clock options with 48MHz Digital Frequency Locked Loop (DFLL48M)
 - External Interrupt Controller (EIC)
 - 16 external interrupts
 - One non-maskable interrupt
 - Two-pin Serial Wire Debug (SWD) programming, test and debugging interface
- Low Power
 - Idle and standby sleep modes
 - SleepWalking peripherals
- Peripherals
 - 8-channel Event System

This is a summary document. A complete document is available on our Web site at www.atmel.com

- Up to five 16-bit Timer/Counters (TC), configurable as either:
 - One 16-bit TC with two compare/capture channels
 - One 8-bit TC with two compare/capture channels
 - One 32-bit TC with two compare/capture channels, by using two TCs
- 32-bit Real Time Counter (RTC) with clock/calendar function
- Watchdog Timer (WDT)
- CRC-32 generator
- Up to six Serial Communication Interfaces (SERCOM), each configurable to operate as either:
 - USART with full-duplex and single-wire half-duplex configuration
 - Inter-Integrated Circuit (I²C) up to 400kHz
 - Serial Peripheral Interface (SPI)
- One 12-bit, 350kps Analog-to-Digital Converter (ADC) with up to 20 channels
 - Differential and single-ended input
 - 1/2x to 16x programmable gain stage
 - Automatic offset and gain error compensation
 - Oversampling and decimation in hardware to support 13-, 14-, 15- or 16-bit resolution
- 10-bit, 350kps Digital-to-Analog Converter (DAC)
- Two Analog Comparators (AC) with window compare function
- Peripheral Touch Controller (PTC)
 - 256-Channel capacitive touch and proximity sensing
- I/O
 - Up to 52 programmable I/O pins
- Packages
 - 64-pin TQFP, QFN
 - 64-ball UFBGA
 - 48-pin TQFP, QFN
 - 45-ball WLCSP
 - 32-pin TQFP, QFN
- Operating Voltage
 - 1.62V – 3.63V
- Power Consumption
 - Down to 70µA/MHz in active mode
 - Down to 8µA running the Peripheral Touch Controller

Table of Contents

Introduction.....	1
Features.....	1
1. Description.....	4
2. Configuration Summary.....	5
3. Ordering Information.....	6
3.1. SAM D20E.....	6
3.2. SAM D20G.....	8
3.3. SAM D20J.....	9
3.4. Device Identification.....	11
4. Block Diagram.....	13
5. Pinout.....	14
5.1. SAM D20J.....	14
5.2. SAM D20G.....	16
5.3. SAM D20E.....	18
6. Product Mapping.....	19
7. Processor And Architecture.....	20
7.1. Cortex M0+ Processor.....	20
7.2. Nested Vector Interrupt Controller.....	21
7.3. Micro Trace Buffer.....	23
7.4. High-Speed Bus System.....	24
7.5. AHB-APB Bridge.....	24
7.6. PAC - Peripheral Access Controller.....	25
7.7. Register Description.....	26
8. Packaging Information.....	39
8.1. Thermal Considerations.....	39
8.2. Package Drawings.....	40
8.3. Soldering Profile.....	50

1. Description

The Atmel® | SMART™ SAM D20 is a series of low-power microcontrollers using the 32-bit ARM® Cortex®-M0+ processor, and ranging from 32- to 64-pins with up to 256KB Flash and 32KB of SRAM. The SAM D20 devices operate at a maximum frequency of 48MHz and reach 2.46 CoreMark/MHz. They are designed for simple and intuitive migration with identical peripheral modules, hex compatible code, identical linear address map and pin compatible migration paths between all devices in the product series. All devices include intelligent and flexible peripherals, Atmel Event System for inter-peripheral signaling, and support for capacitive touch button, slider and wheel user interfaces.

The SAM D20 devices provide the following features: In-system programmable Flash, eight-channel Event System, programmable interrupt controller, up to 52 programmable I/O pins, 32-bit real-time clock and calendar, up to eight 16-bit Timer/Counters (TC) . The timer/counters can be configured to perform frequency and waveform generation, accurate program execution timing or input capture with time and frequency measurement of digital signals. The TCs can operate in 8- or 16-bit mode, selected TCs can be cascaded to form a 32-bit TC. The series provide up to six Serial Communication Modules (SERCOM) that each can be configured to act as an USART, UART, SPI, I²C up to 400kHz, up to twenty-channel 350ksps 12-bit ADC with programmable gain and optional oversampling and decimation supporting up to 16-bit resolution, one 10-bit 350ksps DAC, two analog comparators with window mode, Peripheral Touch Controller supporting up to 256 buttons, sliders, wheels and proximity sensing; programmable Watchdog Timer, brown-out detector and power-on reset and two-pin Serial Wire Debug (SWD) program and debug interface.

All devices have accurate and low-power external and internal oscillators. All oscillators can be used as a source for the system clock. Different clock domains can be independently configured to run at different frequencies, enabling power saving by running each peripheral at its optimal clock frequency, and thus maintaining a high CPU frequency while reducing power consumption.

The SAM D20 devices have two software-selectable sleep modes, idle and standby. In idle mode the CPU is stopped while all other functions can be kept running. In standby all clocks and functions are stopped except those selected to continue running. The device supports SleepWalking. This feature allows the peripheral to wake up from sleep based on predefined conditions, and thus allows the CPU to wake up only when needed, e.g. when a threshold is crossed or a result is ready. The Event System supports synchronous and asynchronous events, allowing peripherals to receive, react to and send events even in standby mode.

The Flash program memory can be reprogrammed in-system through the SWD interface. The same interface can be used for non-intrusive on-chip debug of application code. A boot loader running in the device can use any communication interface to download and upgrade the application program in the Flash memory.

The SAM D20 devices are supported with a full suite of program and system development tools, including C compilers, macro assemblers, program debugger/simulators, programmers and evaluation kits.

2. Configuration Summary

	SAM D20J	SAM D20G	SAM D20E
Pins	64	48	32
General Purpose I/O-pins (GPIOs)	52	38	26
Flash	256/128/64/32KB	256/128/64/32KB	256/128/64/32KB
SRAM	32/16/8/4/2KB	32/16/8/4/2KB	32/16/8/4/2KB
Timer Counter (TC) instances	8	6	6
Waveform output channels per TC instance	2	2	2
Serial Communication Interface (SERCOM) instances	6	6	4
Analog-to-Digital Converter (ADC) channels	20	14	10
Analog Comparators (AC)	2	2	2
Digital-to-Analog Converter (DAC) channels	1	1	1
Real-Time Counter (RTC)	Yes	Yes	Yes
RTC alarms	1	1	1
RTC compare values	One 32-bit value or two 16-bit values	One 32-bit value or two 16-bit values	One 32-bit value or two 16-bit values
External Interrupt lines	16	16	16
Peripheral Touch Controller (PTC) X and Y lines	16x16	12x10	10x6
Maximum CPU frequency	48MHz		
Packages	QFN TQFP UFBGA	QFN TQFP WLCSP	QFN TQFP
Oscillators	32.768kHz crystal oscillator (XOSC32K) 0.4-32MHz crystal oscillator (XOSC) 32.768kHz internal oscillator (OSC32K) 32KHz ultra-low-power internal oscillator (OSCULP32K) 8MHz high-accuracy internal oscillator (OSC8M) 48MHz Digital Frequency Locked Loop (DFLL48M)		
Event System channels	8	8	8
SW Debug Interface	Yes	Yes	Yes
Watchdog Timer (WDT)	Yes	Yes	Yes

3. Ordering Information

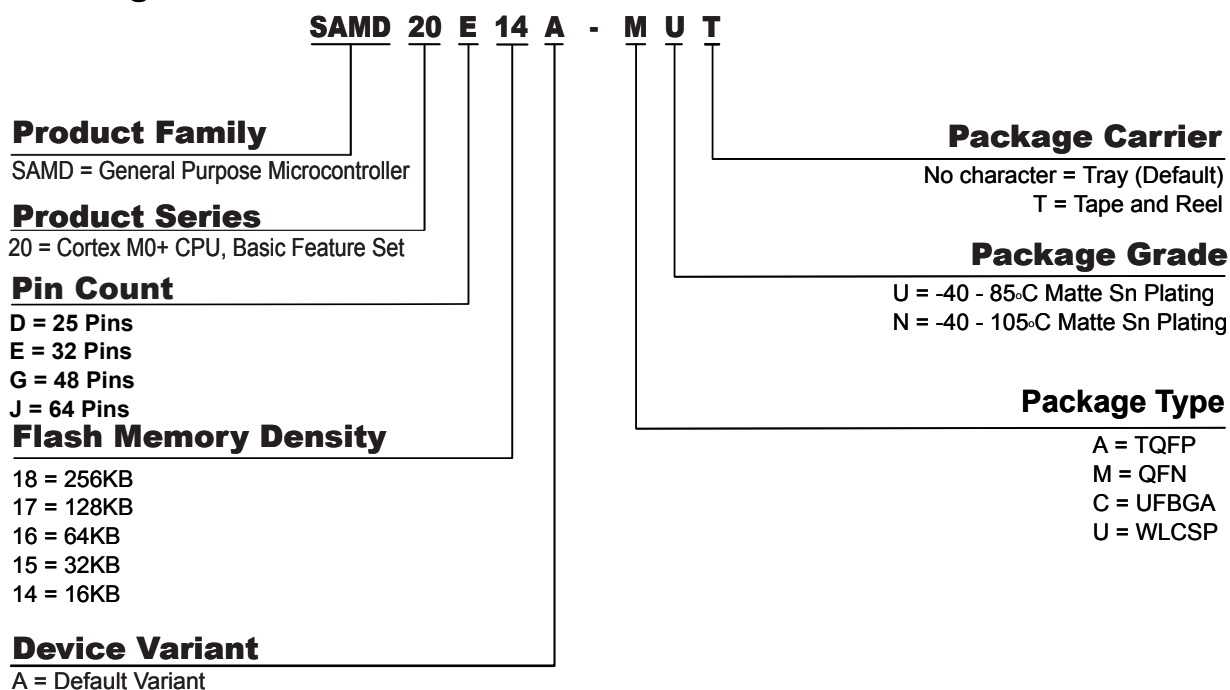

3.1. SAM D20E

Ordering Code	FLASH (bytes)	SRAM (bytes)	Package	Carrier Type
ATSAMD20E14A-AU	16K	2K	TQFP32	Tray
ATSAMD20E14A-AUT				Tape & Reel
ATSAMD20E14A-AN				Tray
ATSAMD20E14A-ANT				Tape & Reel
ATSAMD20E14A-MU			QFN32	Tray
ATSAMD20E14A-MUT				Tape & Reel
ATSAMD20E14A-MN				Tray
ATSAMD20E14A-MNT				Tape & Reel

Ordering Code	FLASH (bytes)	SRAM (bytes)	Package	Carrier Type
ATSAMD20E15A-AU	32K	4K	TQFP32	Tray
ATSAMD20E15A-AUT				Tape & Reel
ATSAMD20E15A-AN				Tray
ATSAMD20E15A-ANT				Tape & Reel
ATSAMD20E15A-MU			QFN32	Tray
ATSAMD20E15A-MUT				Tape & Reel
ATSAMD20E15A-MN				Tray
ATSAMD20E15A-MNT				Tape & Reel
ATSAMD20E16A-AU	64K	8K	TQFP32	Tray
ATSAMD20E16A-AUT				Tape & Reel
ATSAMD20E16A-AN				Tray
ATSAMD20E16A-AFT				Tape & Reel
ATSAMD20E16A-MU			QFN32	Tray
ATSAMD20E16A-MUT				Tape & Reel
ATSAMD20E16A-MN				Tray
ATSAMD20E16A-MNT				Tape & Reel
ATSAMD20E17A-AU	128K	16K	TQFP32	Tray
ATSAMD20E17A-AUT				Tape & Reel
ATSAMD20E17A-AN				Tray
ATSAMD20E17A-ANT				Tape & Reel
ATSAMD20E17A-MU			QFN32	Tray
ATSAMD20E17A-MUT				Tape & Reel
ATSAMD20E17A-MN				Tray
ATSAMD20E17A-MNT				Tape & Reel
ATSAMD20E18A-AU	256K	32K	TQFP32	Tray
ATSAMD20E18A-AUT				Tape & Reel
ATSAMD20E18A-AN				Tray
ATSAMD20E18A-AFT				Tape & Reel
ATSAMD20E18A-MU			QFN32	Tray
ATSAMD20E18A-MUT				Tape & Reel
ATSAMD20E18A-MN				Tray
ATSAMD20E18A-MNT				Tape & Reel

3.2. SAM D20G

Ordering Code	FLASH (bytes)	SRAM (bytes)	Package	Carrier Type
ATSAMD20G14A-AU	16K	2K	TQFP32	Tray
ATSAMD20G14A-AUT				Tape & Reel
ATSAMD20G14A-AN				Tray
ATSAMD20G14A-ANT				Tape & Reel
ATSAMD20G14A-MU			QFN32	Tray
ATSAMD20G14A-MUT				Tape & Reel
ATSAMD20G14A-MN				Tray
ATSAMD20G14A-MNT				Tape & Reel
ATSAMD20G15A-AU	32K	4K	TQFP48	Tray
ATSAMD20G15A-AUT				Tape & Reel
ATSAMD20G15A-AN				Tray
ATSAMD20G15A-ANT				Tape & Reel
ATSAMD20G15A-MU			QFN48	Tray
ATSAMD20G15A-MUT				Tape & Reel
ATSAMD20G15A-MN				Tray
ATSAMD20G15A-MNT				Tape & Reel
ATSAMD20G16A-AU	64K	8K	TQFP48	Tray
ATSAMD20G16A-AUT				Tape & Reel
ATSAMD20G16A-AN				Tray
ATSAMD20G16A-ANT				Tape & Reel
ATSAMD20G16A-MU			QFN48	Tray
ATSAMD20G16A-MUT				Tape & Reel
ATSAMD20G16A-MN				Tray
ATSAMD20G16A-MNT				Tape & Reel

Ordering Code	FLASH (bytes)	SRAM (bytes)	Package	Carrier Type
ATSAMD20G17A-AU	128K	16K	TQFP48	Tray
ATSAMD20G17A-AUT				Tape & Reel
ATSAMD20G17A-AN				Tray
ATSAMD20G17A-ANT				Tape & Reel
ATSAMD20G17A-MU			QFN48	Tray
ATSAMD20G17A-MUT				Tape & Reel
ATSAMD20G17A-MN				Tray
ATSAMD20G17A-MNT				Tape & Reel
ATSAMD20G17A-UUT			WLCSP45	Tape & Reel
ATSAMD20G18A-AU			256K	32K
ATSAMD20G18A-AUT	Tape & Reel			
ATSAMD20G18A-AN	Tray			
ATSAMD20G18A-ANT	Tape & Reel			
ATSAMD20G18A-MU	QFN48	Tray		
ATSAMD20G18A-MUT		Tape & Reel		
ATSAMD20G18A-MN		Tray		
ATSAMD20G18A-MNT		Tape & Reel		
ATSAMD20G18A-UUT	WLCSP45	Tape & Reel		

3.3. SAM D20J

Ordering Code	FLASH (bytes)	SRAM (bytes)	Package	Carrier Type
ATSAMD20J14A-AU	16K	2K	TQFP64	Tray
ATSAMD20J14A-AUT				Tape & Reel
ATSAMD20J14A-AN				Tray
ATSAMD20J14A-ANT				Tape & Reel
ATSAMD20J14A-MU			QFN64	Tray
ATSAMD20J14A-MUT				Tape & Reel
ATSAMD20J14A-MN				Tray
ATSAMD20J14A-MNT				Tape & Reel

Ordering Code	FLASH (bytes)	SRAM (bytes)	Package	Carrier Type
ATSAMD20J15A-AU	32K	4K	TQFP64	Tray
ATSAMD20J15A-AUT				Tape & Reel
ATSAMD20J15A-AN				Tray
ATSAMD20J15A-ANT				Tape & Reel
ATSAMD20J15A-MU			QFN64	Tray
ATSAMD20J15A-MUT				Tape & Reel
ATSAMD20J15A-MN				Tray
ATSAMD20J15A-MNT				Tape & Reel
ATSAMD20J16A-AU	64K	8K	TQFP64	Tray
ATSAMD20J16A-AUT				Tape & Reel
ATSAMD20J16A-AN				Tray
ATSAMD20J16A-ANT				Tape & Reel
ATSAMD20J16A-MU			QFN64	Tray
ATSAMD20J16A-MUT				Tape & Reel
ATSAMD20J16A-MN				Tray
ATSAMD20J16A-MNT				Tape & Reel
ATSAMD20J16A-CU			UFBGA64	Tray
ATSAMD20J16A-CUT				Tape & Reel
ATSAMD20J17A-AU	128K	16K	TQFP64	Tray
ATSAMD20J17A-AUT				Tape & Reel
ATSAMD20J17A-AN				Tray
ATSAMD20J17A-ANT				Tape & Reel
ATSAMD20J17A-MU			QFN64	Tray
ATSAMD20J17A-MUT				Tape & Reel
ATSAMD20J17A-MN				Tray
ATSAMD20J17A-MNT				Tape & Reel
ATSAMD20J17A-CU			UFBGA64	Tray
ATSAMD20J17A-CUT				Tape & Reel

Ordering Code	FLASH (bytes)	SRAM (bytes)	Package	Carrier Type
ATSAMD20J18A-AU	256K	32K	TQFP64	Tray
ATSAMD20J18A-AUT				Tape & Reel
ATSAMD20J18A-AN				Tray
ATSAMD20J18A-ANT				Tape & Reel
ATSAMD20J18A-MU			QFN64	Tray
ATSAMD20J18A-MUT				Tape & Reel
ATSAMD20J18A-MN				Tray
ATSAMD20J18A-MNT				Tape & Reel
ATSAMD20J18A-CU			UFBGA64	Tray
ATSAMD20J18A-CUT				Tape & Reel

3.4. Device Identification

The DSU - Device Service Unit peripheral provides the Device Selection bits in the Device Identification register (DID.DEVSEL) in order to identify the device by software. The device variants have a reset value of DID=0x1001drxx, with the LSB identifying the die number ('d'), the die revision ('r') and the device selection ('xx').

Table 3-1. Device Identification Values

Device Variant	DID.DEVSEL	Device ID (DID)
SAMD20J18C	0x00	0x10001300
SAMD20J18A	0x00	0x10001300
SAMD20J17A	0x01	0x10001301
SAMD20J16A	0x02	0x10001302
SAMD20J15A	0x03	0x10001303
SAMD20J14A	0x04	0x10001304
SAMD20G18A	0x05	0x10001305
SAMD20G17A	0x06	0x10001306
SAMD20G16A	0x07	0x10001307
SAMD20G15A	0x08	0x10001308
SAMD20G14A	0x09	0x10001309
SAMD20E18A	0x0A	0x1000130A
SAMD20E17A	0x0B	0x1000130B
SAMD20E16A	0x0C	0x1000130C
SAMD20E15A	0x0D	0x1000130D

Device Variant	DID.DEVSEL	Device ID (DID)
SAMD20E14A	0x0E	0x1000130E
Reserved	0x0F	
SAMD20G18U	0x10	0x10001310
SAMD20G17U	0x11	0x10001311
Reserved	0x12 - 0xFF	

Note: The device variant (last letter of the ordering number) is independent of the die revision (DSU.DID.REVISION): The device variant denotes functional differences, whereas the die revision marks evolution of the die. The device variant denotes functional differences, whereas the die revision marks evolution of the die.

4. Block Diagram

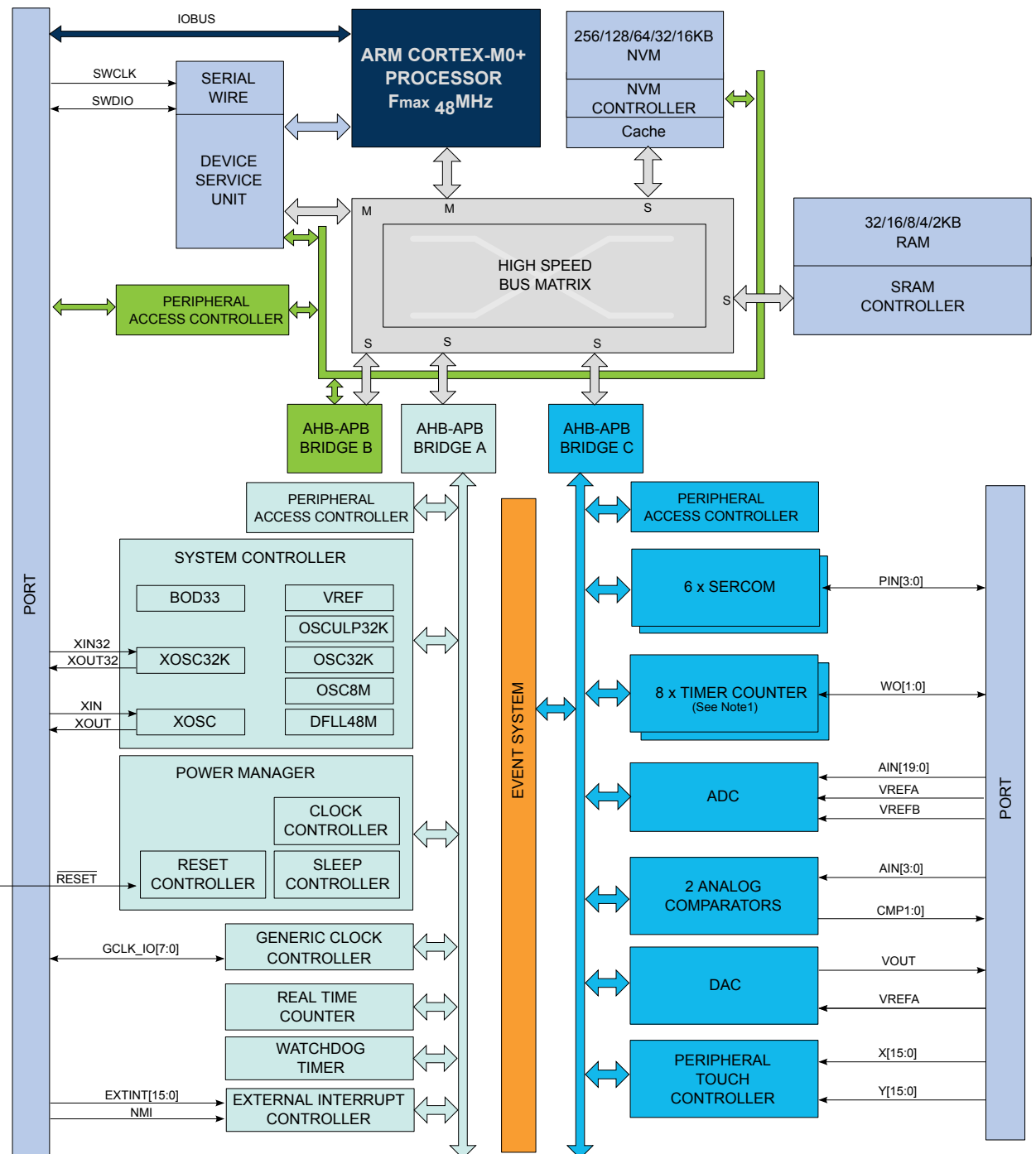

Note: 1. Some products have different number of SERCOM instances, Timer/Counter instances, PTC signals and ADC signals. Refer to *Peripherals Configuration Summary* for details.

5. Pinout

5.1. SAM D20J

5.1.1. QFN64 / TQFP64



5.1.2. UFBGA64

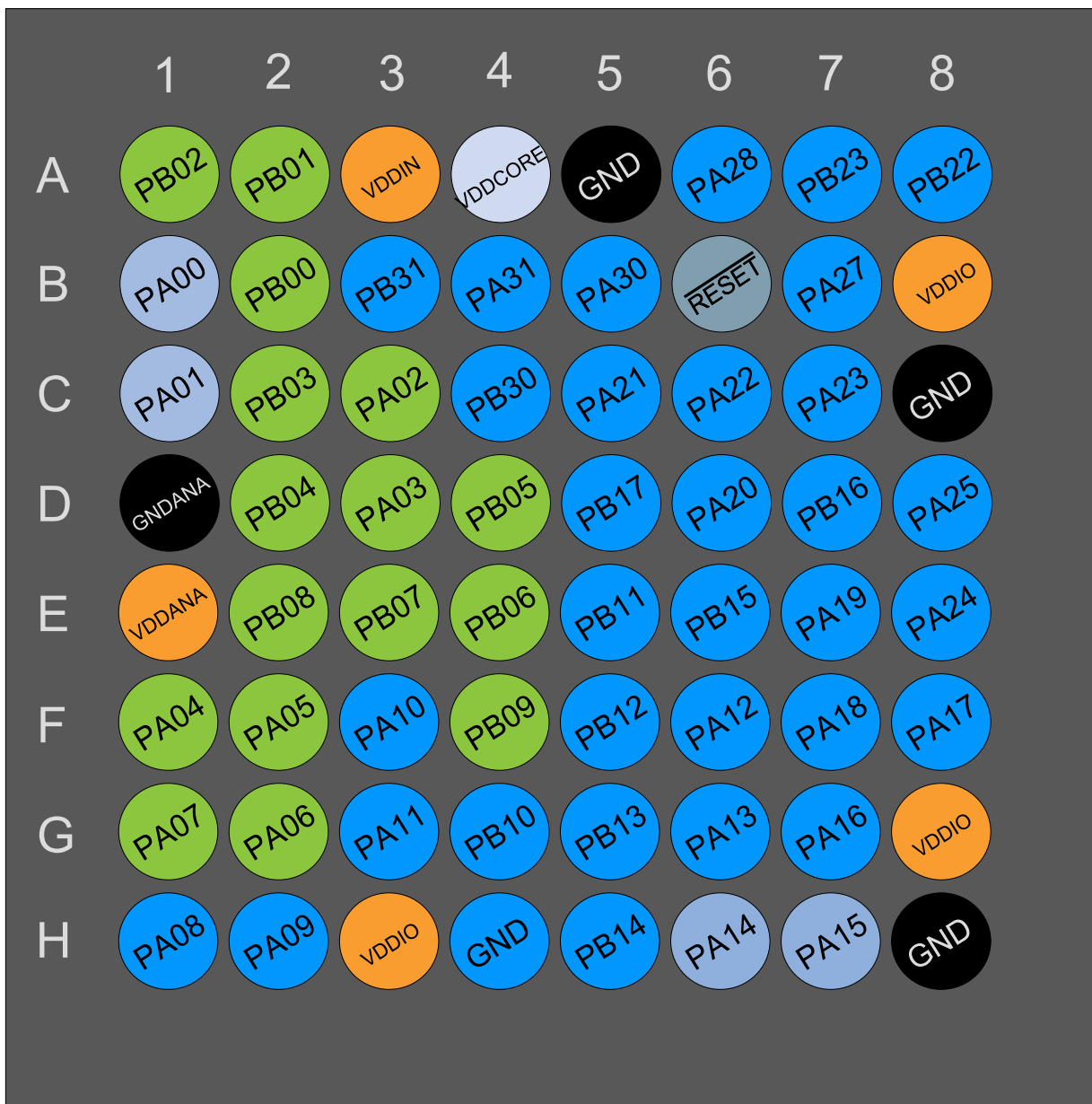

- DIGITAL PIN
- ANALOG PIN
- OSCILLATOR
- GROUND
- INPUT SUPPLY
- REGULATED OUTPUT SUPPLY
- RESET PIN

5.2. SAM D20G

5.2.1. QFN48 / TQFP48



5.2.2. WLCSP45



- DIGITAL PIN
- ANALOG PIN
- OSCILLATOR
- GROUND
- INPUT SUPPLY
- REGULATED OUTPUT SUPPLY
- RESET PIN

5.3. SAM D20E

5.3.1. QFN32 / TQFP32

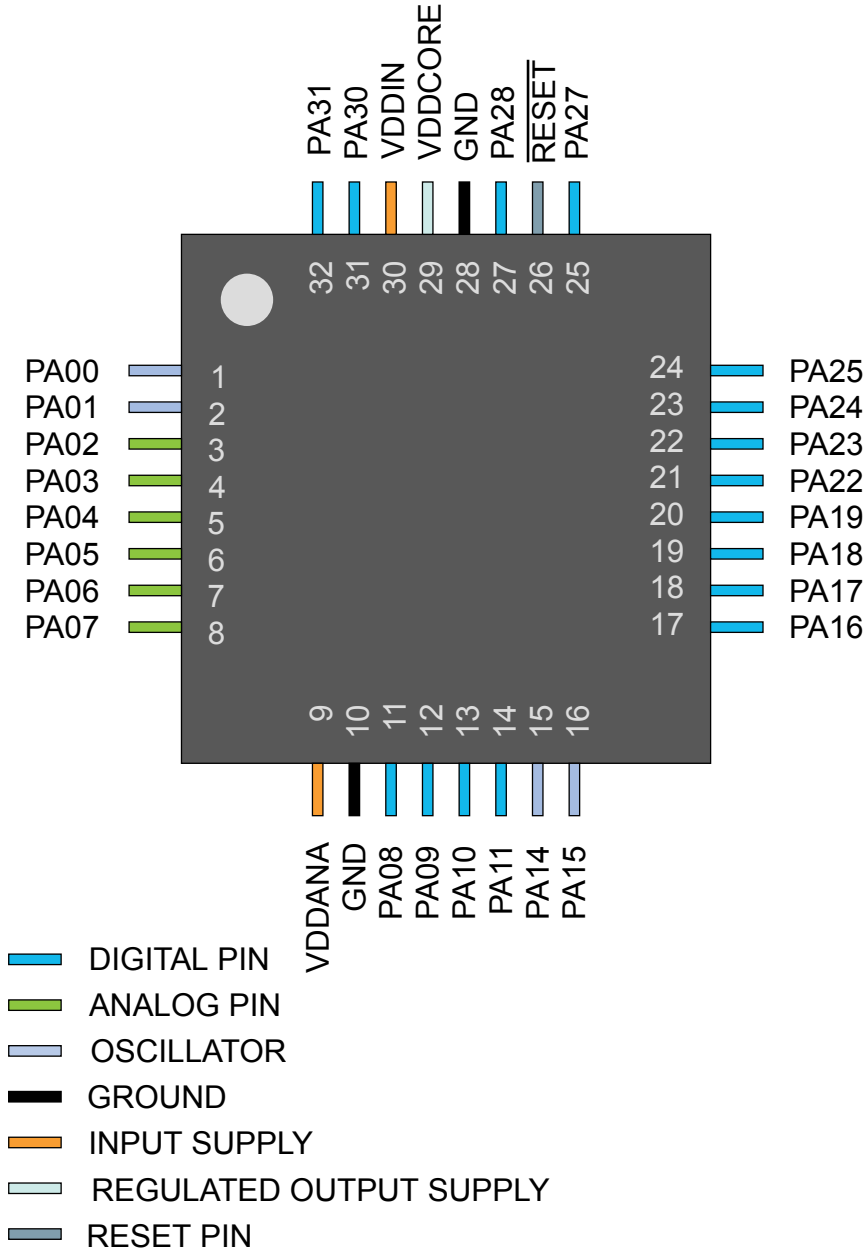

6. Product Mapping

Figure 6-1. Product Mapping



This figure represents the full configuration of the SAM D20 device with maximum flash and SRAM capabilities and a full set of peripherals. Refer to the [Configuration Summary](#) for details.

7. Processor And Architecture

7.1. Cortex M0+ Processor

The SAM D20 implements the ARM® Cortex®-M0+ processor, based on the ARMv6 Architecture and Thumb®-2 ISA. The Cortex M0+ is 100% instruction set compatible with its predecessor, the Cortex-M0 core, and upward compatible to Cortex-M3 and M4 cores. The ARM Cortex-M0+ implemented is revision r0p1. For more information refer to <http://www.arm.com>.

7.1.1. Cortex M0+ Configuration

Table 7-1. Cortex M0+ Configuration

Features	Configurable option	Device configuration
Interrupts	External interrupts 0-32	28
Data endianness	Little-endian or big-endian	Little-endian
SysTick timer	Present or absent	Present
Number of watchpoint comparators	0, 1, 2	2
Number of breakpoint comparators	0, 1, 2, 3, 4	4
Halting debug support	Present or absent	Present
Multiplier	Fast or small	Fast (single cycle)
Single-cycle I/O port	Present or absent	Present
Wake-up interrupt controller	Supported or not supported	Not supported
Vector Table Offset Register	Present or absent	Present
Unprivileged/Privileged support	Present or absent	Absent ⁽¹⁾
Memory Protection Unit	Not present or 8-region	Not present
Reset all registers	Present or absent	Absent
Instruction fetch width	16-bit only or mostly 32-bit	32-bit

Note:

1. All software run in privileged mode only.

The ARM Cortex-M0+ core has two bus interfaces:

- Single 32-bit AMBA-3 AHB-Lite system interface that provides connections to peripherals and all system memory, which includes flash and RAM.
- Single 32-bit I/O port bus interfacing to the PORT with 1-cycle loads and stores.

7.1.2. Cortex-M0+ Peripherals

- System Control Space (SCS)
 - The processor provides debug through registers in the SCS. Refer to the Cortex-M0+ Technical Reference Manual for details (www.arm.com).
- System Timer (SysTick)

- The System Timer is a 24-bit timer that extends the functionality of both the processor and the NVIC. Refer to the Cortex-M0+ Technical Reference Manual for details (www.arm.com).
- Nested Vectored Interrupt Controller (NVIC)
 - External interrupt signals connect to the NVIC, and the NVIC prioritizes the interrupts. Software can set the priority of each interrupt. The NVIC and the Cortex-M0+ processor core are closely coupled, providing low latency interrupt processing and efficient processing of late arriving interrupts. Refer to [Nested Vector Interrupt Controller](#) and the Cortex-M0+ Technical Reference Manual for details (www.arm.com).
- System Control Block (SCB)
 - The System Control Block provides system implementation information, and system control. This includes configuration, control, and reporting of the system exceptions. Refer to the Cortex-M0+ Devices Generic User Guide for details (www.arm.com).
- Micro Trace Buffer (MTB)
 - The CoreSight MTB-M0+ (MTB) provides a simple execution trace capability to the Cortex-M0+ processor. Refer to section [Micro Trace Buffer](#) and the CoreSight MTB-M0+ Technical Reference Manual for details (www.arm.com).

7.1.3. Cortex-M0+ Address Map

Table 7-2. Cortex-M0+ Address Map

Address	Peripheral
0xE000E000	System Control Space (SCS)
0xE000E010	System Timer (SysTick)
0xE000E100	Nested Vectored Interrupt Controller (NVIC)
0xE000ED00	System Control Block (SCB)
0x41006000 (see also Product Mapping)	Micro Trace Buffer (MTB)

7.1.4. I/O Interface

7.1.4.1. Overview

Because accesses to the AMBA® AHB-Lite™ and the single cycle I/O interface can be made concurrently, the Cortex-M0+ processor can fetch the next instructions while accessing the I/Os. This enables single cycle I/O accesses to be sustained for as long as needed. Refer to *CPU Local Bus* for more information.

7.1.4.2. Description

Direct access to PORT registers.

7.2. Nested Vector Interrupt Controller

7.2.1. Overview

The Nested Vectored Interrupt Controller (NVIC) in the SAM D20 supports 32 interrupt lines with four different priority levels. For more details, refer to the Cortex-M0+ Technical Reference Manual (www.arm.com).

7.2.2. Interrupt Line Mapping

Each of the 28 interrupt lines is connected to one peripheral instance, as shown in the table below. Each peripheral can have one or more interrupt flags, located in the peripheral's Interrupt Flag Status and Clear

(INTFLAG) register. The interrupt flag is set when the interrupt condition occurs. Each interrupt in the peripheral can be individually enabled by writing a one to the corresponding bit in the peripheral's Interrupt Enable Set (INTENSET) register, and disabled by writing a one to the corresponding bit in the peripheral's Interrupt Enable Clear (INTENCLR) register. An interrupt request is generated from the peripheral when the interrupt flag is set and the corresponding interrupt is enabled. The interrupt requests for one peripheral are ORed together on system level, generating one interrupt request for each peripheral. An interrupt request will set the corresponding interrupt pending bit in the NVIC interrupt pending registers (SETPEND/CLRPEND bits in ISPR/ICPR). For the NVIC to activate the interrupt, it must be enabled in the NVIC interrupt enable register (SETENA/CLRENA bits in ISER/ICER). The NVIC interrupt priority registers IPR0-IPR7 provide a priority field for each interrupt.

Table 7-3. Interrupt Line Mapping

Peripheral Source	NVIC Line
EIC NMI – External Interrupt Controller	NMI
PM – Power Manager	0
SYSCTRL – System Control	1
WDT – Watchdog Timer	2
RTC – Real Time Counter	3
EIC – External Interrupt Controller	4
NVMCTRL – Non-Volatile Memory Controller	5
EVSYS – Event System	6
SERCOM0 – Serial Communication Interface 0	7
SERCOM1 – Serial Communication Interface 1	8
SERCOM2 – Serial Communication Interface 2	9
SERCOM3 – Serial Communication Interface 3	10
SERCOM4 – Serial Communication Interface 4	11
SERCOM5 – Serial Communication Interface 5	12
TC0 – Timer Counter 0	13
TC1 – Timer Counter 1	14
TC2 – Timer Counter 2	15
TC3 – Timer Counter 3	16
TC4 – Timer Counter 4	17
TC5 – Timer Counter 5	18
TC6 – Timer Counter 6	19
TC7 – Timer Counter 7	20
ADC – Analog-to-Digital Converter	21
AC – Analog Comparator	22

Peripheral Source	NVIC Line
DAC – Digital-to-Analog Converter	23
PTC – Peripheral Touch Controller	24

7.3. Micro Trace Buffer

7.3.1. Features

- Program flow tracing for the Cortex-M0+ processor
- MTB SRAM can be used for both trace and general purpose storage by the processor
- The position and size of the trace buffer in SRAM is configurable by software
- CoreSight compliant

7.3.2. Overview

When enabled, the MTB records changes in program flow, reported by the Cortex-M0+ processor over the execution trace interface shared between the Cortex-M0+ processor and the CoreSight MTB-M0+. This information is stored as trace packets in the SRAM by the MTB. An off-chip debugger can extract the trace information using the Debug Access Port to read the trace information from the SRAM. The debugger can then reconstruct the program flow from this information.

The MTB simultaneously stores trace information into the SRAM, and gives the processor access to the SRAM. The MTB ensures that trace write accesses have priority over processor accesses.

The execution trace packet consists of a pair of 32-bit words that the MTB generates when it detects the processor PC value changes non-sequentially. A non-sequential PC change can occur during branch instructions or during exception entry. See the CoreSight MTB-M0+ Technical Reference Manual for more details on the MTB execution trace packet format.

Tracing is enabled when the MASTER.EN bit in the Master Trace Control Register is 1. There are various ways to set the bit to 1 to start tracing, or to 0 to stop tracing. See the CoreSight Cortex-M0+ Technical Reference Manual for more details on the Trace start and stop and for a detailed description of the MTB's MASTER register. The MTB can be programmed to stop tracing automatically when the memory fills to a specified watermark level or to start or stop tracing by writing directly to the MASTER.EN bit. If the watermark mechanism is not being used and the trace buffer overflows, then the buffer wraps around overwriting previous trace packets.

The base address of the MTB registers is 0x41006000; this address is also written in the CoreSight ROM Table. The offset of each register from the base address is fixed and as defined by the CoreSight MTB-M0+ Technical Reference Manual. The MTB has 4 programmable registers to control the behavior of the trace features:

- POSITION: Contains the trace write pointer and the wrap bit,
- MASTER: Contains the main trace enable bit and other trace control fields,
- FLOW: Contains the WATERMARK address and the AUTOSTOP and AUTOHALT control bits,
- BASE: Indicates where the SRAM is located in the processor memory map. This register is provided to enable auto discovery of the MTB SRAM location, by a debug agent.

See the CoreSight MTB-M0+ Technical Reference Manual for a detailed description of these registers.

7.4. High-Speed Bus System

7.4.1. Features

High-Speed Bus Matrix has the following features:

- Symmetric crossbar bus switch implementation
- Allows concurrent accesses from different masters to different slaves
- 32-bit data bus
- Operation at a one-to-one clock frequency with the bus masters

7.4.2. Configuration

Table 7-4. Bus Matrix Masters

Bus Matrix Masters	Master ID
CM0+ - Cortex M0+ Processor	0
DSU - Device Service Unit	1

Table 7-5. Bus Matrix Slaves

Bus Matrix Slaves	Slave ID
Internal Flash Memory	0
AHB-APB Bridge A	1
AHB-APB Bridge B	2
AHB-APB Bridge C	3

7.5. AHB-APB Bridge

The AHB-APB bridge is an AHB slave, providing an interface between the high-speed AHB domain and the low-power APB domain. It is used to provide access to the programmable control registers of peripherals (see *Product Mapping*).

AHB-APB bridge is based on AMBA APB Protocol Specification V2.0 (ref. as APB4) including:

- Wait state support
- Error reporting
- Transaction protection
- Sparse data transfer (byte, half-word and word)

Additional enhancements:

- Address and data cycles merged into a single cycle
- Sparse data transfer also apply to read access

to operate the AHB-APB bridge, the clock (CLK_HPbX_AHB) must be enabled. See *PM – Power Manager* for details.

Figure 7-1. APB Write Access.



Figure 7-2. APB Read Access.



Related Links

[Product Mapping](#) on page 19

7.6. PAC - Peripheral Access Controller

7.6.1. Overview

There is one PAC associated with each AHB-APB bridge. The PAC can provide write protection for registers of each peripheral connected on the same bridge.

The PAC peripheral bus clock (CLK_PACx_APB) can be enabled and disabled in the Power Manager. CLK_PAC0_APB and CLK_PAC1_APB are enabled at reset. CLK_PAC2_APB is disabled at reset. Refer to *PM – Power Manager* for details. The PAC will continue to operate in any sleep mode where the selected clock source is running. Write-protection does not apply for debugger access. When the debugger makes an access to a peripheral, write-protection is ignored so that the debugger can update the register.

Write-protect registers allow the user to disable a selected peripheral's write-protection without doing a read-modify-write operation. These registers are mapped into two I/O memory locations, one for clearing and one for setting the register bits. Writing a one to a bit in the Write Protect Clear register (WPCLR) will clear the corresponding bit in both registers (WPCLR and WPSET) and disable the write-protection for the corresponding peripheral, while writing a one to a bit in the Write Protect Set (WPSET) register will set the corresponding bit in both registers (WPCLR and WPSET) and enable the write-protection for the corresponding peripheral. Both registers (WPCLR and WPSET) will return the same value when read.

If a peripheral is write-protected, and if a write access is performed, data will not be written, and the peripheral will return an access error (CPU exception).

The PAC also offers a safety feature for correct program execution, with a CPU exception generated on double write-protection or double unprotection of a peripheral. If a peripheral *n* is write-protected and a write to one in WPSET[*n*] is detected, the PAC returns an error. This can be used to ensure that the application follows the intended program flow by always following a write-protect with an unprotect, and vice versa. However, in applications where a write-protected peripheral is used in several contexts, e.g., interrupts, care should be taken so that either the interrupt can not happen while the main application or other interrupt levels manipulate the write-protection status, or when the interrupt handler needs to unprotect the peripheral, based on the current protection status, by reading WPSET.

7.7. Register Description

Atomic 8-, 16- and 32-bit accesses are supported. In addition, the 8-bit quarters and 16-bit halves of a 32-bit register, and the 8-bit halves of a 16-bit register can be accessed directly. Refer to the Product Mapping for PAC locations.

Related Links

[Product Mapping](#) on page 19

7.7.1. PAC0 Register Description

7.7.1.1. Write Protect Clear

Name: WPCLR
Offset: 0x00
Reset: 0x000000
Property: –

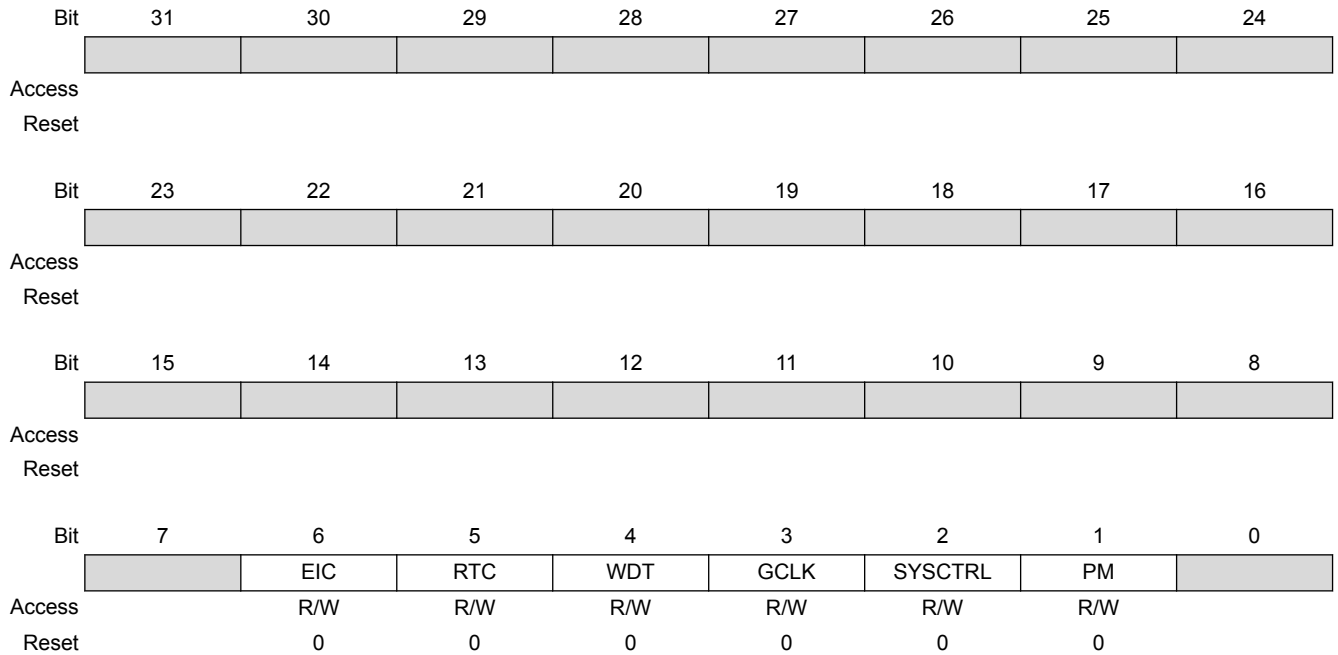

Bit 6 – EIC

Writing a zero to these bits has no effect.

Writing a one to these bits will clear the Write Protect bit for the corresponding peripherals.

Value	Description
0	Write-protection is disabled.
1	Write-protection is enabled.

Bit 5 – RTC

Writing a zero to these bits has no effect.

Writing a one to these bits will clear the Write Protect bit for the corresponding peripherals.

Value	Description
0	Write-protection is disabled.
1	Write-protection is enabled.

Bit 4 – WDT

Writing a zero to these bits has no effect.

Writing a one to these bits will clear the Write Protect bit for the corresponding peripherals.

Value	Description
0	Write-protection is disabled.
1	Write-protection is enabled.

Bit 3 – GCLK

Writing a zero to these bits has no effect.

Writing a one to these bits will clear the Write Protect bit for the corresponding peripherals.

Value	Description
0	Write-protection is disabled.
1	Write-protection is enabled.

Bit 2 – SYSCTRL

Writing a zero to these bits has no effect.

Writing a one to these bits will clear the Write Protect bit for the corresponding peripherals.

Value	Description
0	Write-protection is disabled.
1	Write-protection is enabled.

Bit 1 – PM

Writing a zero to these bits has no effect.

Writing a one to these bits will clear the Write Protect bit for the corresponding peripherals.

Value	Description
0	Write-protection is disabled.
1	Write-protection is enabled.

7.7.1.2. Write Protect Set

Name: WPSET
Offset: 0x04
Reset: 0x000000
Property: –



Bit 6 – EIC

Writing a zero to these bits has no effect.

Writing a one to these bits will clear the Write Protect bit for the corresponding peripherals.

Value	Description
0	Write-protection is disabled.
1	Write-protection is enabled.

Bit 5 – RTC

Writing a zero to these bits has no effect.

Writing a one to these bits will clear the Write Protect bit for the corresponding peripherals.

Value	Description
0	Write-protection is disabled.
1	Write-protection is enabled.

Bit 4 – WDT

Writing a zero to these bits has no effect.

Writing a one to these bits will clear the Write Protect bit for the corresponding peripherals.

Value	Description
0	Write-protection is disabled.
1	Write-protection is enabled.

Bit 3 – GCLK

Writing a zero to these bits has no effect.

Writing a one to these bits will clear the Write Protect bit for the corresponding peripherals.

Value	Description
0	Write-protection is disabled.
1	Write-protection is enabled.

Bit 2 – SYSCTRL

Writing a zero to these bits has no effect.

Writing a one to these bits will clear the Write Protect bit for the corresponding peripherals.

Value	Description
0	Write-protection is disabled.
1	Write-protection is enabled.

Bit 1 – PM

Writing a zero to these bits has no effect.

Writing a one to these bits will clear the Write Protect bit for the corresponding peripherals.

Value	Description
0	Write-protection is disabled.
1	Write-protection is enabled.

7.7.2. PAC1 Register Description

7.7.2.1. Write Protect Clear

Name: WPCLR
Offset: 0x00
Reset: 0x000002
Property: –



Bit 6 – MTB

Writing a zero to these bits has no effect.

Writing a one to these bits will clear the Write Protect bit for the corresponding peripherals.

Value	Description
0	Write-protection is disabled.
1	Write-protection is enabled.

Bit 3 – PORT

Writing a zero to these bits has no effect.

Writing a one to these bits will clear the Write Protect bit for the corresponding peripherals.

Value	Description
0	Write-protection is disabled.
1	Write-protection is enabled.

Bit 2 – NVMCTRL

Writing a zero to these bits has no effect.

Writing a one to these bits will clear the Write Protect bit for the corresponding peripherals.

Value	Description
0	Write-protection is disabled.
1	Write-protection is enabled.

Bit 1 – DSU

Writing a zero to these bits has no effect.

Writing a one to these bits will clear the Write Protect bit for the corresponding peripherals.

Value	Description
0	Write-protection is disabled.
1	Write-protection is enabled.

7.7.2.2. Write Protect Set

Name: WPSET
Offset: 0x04
Reset: 0x000002
Property: –



Bit 6 – MTB

Writing a zero to these bits has no effect.

Writing a one to these bits will clear the Write Protect bit for the corresponding peripherals.

Value	Description
0	Write-protection is disabled.
1	Write-protection is enabled.

Bit 3 – PORT

Writing a zero to these bits has no effect.

Writing a one to these bits will clear the Write Protect bit for the corresponding peripherals.

Value	Description
0	Write-protection is disabled.
1	Write-protection is enabled.

Bit 2 – NVMCTRL

Writing a zero to these bits has no effect.

Writing a one to these bits will clear the Write Protect bit for the corresponding peripherals.

Value	Description
0	Write-protection is disabled.
1	Write-protection is enabled.

Bit 1 – DSU

Writing a zero to these bits has no effect.

Writing a one to these bits will clear the Write Protect bit for the corresponding peripherals.

Value	Description
0	Write-protection is disabled.
1	Write-protection is enabled.

7.7.3. PAC2 Register Description

7.7.3.1. Write Protect Clear

Name: WPCLR
Offset: 0x00
Reset: 0x00800000
Property: –

Bit	31	30	29	28	27	26	25	24
Access								
Reset								
Bit	23	22	21	20	19	18	17	16
Access					PTC	DAC	AC	ADC
Reset					0	0	0	0
Bit	15	14	13	12	11	10	9	8
Access	TC7	TC6	TC5	TC4	TC3	TC2	TC1	TC0
Reset	0	0	0	0	0	0	0	0
Bit	7	6	5	4	3	2	1	0
Access	SERCOM5	SERCOM4	SERCOM3	SERCOM2	SERCOM1	SERCOM0	EVSYS	
Reset	0	0	0	0	0	0	0	

Bit 19 – PTC

Writing a zero to these bits has no effect.

Writing a one to these bits will clear the Write Protect bit for the corresponding peripherals.

Value	Description
0	Write-protection is disabled.
1	Write-protection is enabled.

Bit 18 – DAC

Writing a zero to these bits has no effect.

Writing a one to these bits will clear the Write Protect bit for the corresponding peripherals.

Value	Description
0	Write-protection is disabled.
1	Write-protection is enabled.

Bit 17 – AC

Writing a zero to these bits has no effect.

Writing a one to these bits will clear the Write Protect bit for the corresponding peripherals.

Value	Description
0	Write-protection is disabled.
1	Write-protection is enabled.

Bit 16 – ADC

Writing a zero to these bits has no effect.

Writing a one to these bits will clear the Write Protect bit for the corresponding peripherals.

Value	Description
0	Write-protection is disabled.
1	Write-protection is enabled.

Bits 15,14,13,12,11,10,9,8 – TCx

Writing a zero to these bits has no effect.

Writing a one to these bits will clear the Write Protect bit for the corresponding peripherals.

Value	Description
0	Write-protection is disabled.
1	Write-protection is enabled.

Bits 7,6,5,4,3,2 – SERCOMx

Writing a zero to these bits has no effect.

Writing a one to these bits will clear the Write Protect bit for the corresponding peripherals.

Value	Description
0	Write-protection is disabled.
1	Write-protection is enabled.

Bit 1 – EVSYS

Writing a zero to these bits has no effect.

Writing a one to these bits will clear the Write Protect bit for the corresponding peripherals.

Value	Description
0	Write-protection is disabled.
1	Write-protection is enabled.

7.7.3.2. Write Protect Set

Name: WPSET
Offset: 0x04
Reset: 0x00800000
Property: –

Bit	31	30	29	28	27	26	25	24
Access								
Reset								
Bit	23	22	21	20	19	18	17	16
Access					PTC	DAC	AC	ADC
Reset					0	0	0	0
Bit	15	14	13	12	11	10	9	8
Access	TC7	TC6	TC5	TC4	TC3	TC2	TC1	TC0
Reset	0	0	0	0	0	0	0	0
Bit	7	6	5	4	3	2	1	0
Access	SERCOM5	SERCOM4	SERCOM3	SERCOM2	SERCOM1	SERCOM0	EVSYS	
Reset	0	0	0	0	0	0	0	

Bit 19 – PTC

Writing a zero to these bits has no effect.

Writing a one to these bits will clear the Write Protect bit for the corresponding peripherals.

Value	Description
0	Write-protection is disabled.
1	Write-protection is enabled.

Bit 18 – DAC

Writing a zero to these bits has no effect.

Writing a one to these bits will clear the Write Protect bit for the corresponding peripherals.

Value	Description
0	Write-protection is disabled.
1	Write-protection is enabled.

Bit 17 – AC

Writing a zero to these bits has no effect.

Writing a one to these bits will clear the Write Protect bit for the corresponding peripherals.

Value	Description
0	Write-protection is disabled.
1	Write-protection is enabled.

Bit 16 – ADC

Writing a zero to these bits has no effect.

Writing a one to these bits will clear the Write Protect bit for the corresponding peripherals.

Value	Description
0	Write-protection is disabled.
1	Write-protection is enabled.

Bits 15,14,13,12,11,10,9,8 – TCx

Writing a zero to these bits has no effect.

Writing a one to these bits will clear the Write Protect bit for the corresponding peripherals.

Value	Description
0	Write-protection is disabled.
1	Write-protection is enabled.

Bits 7,6,5,4,3,2 – SERCOMx

Writing a zero to these bits has no effect.

Writing a one to these bits will clear the Write Protect bit for the corresponding peripherals.

Value	Description
0	Write-protection is disabled.
1	Write-protection is enabled.

Bit 1 – EVSYS

Writing a zero to these bits has no effect.

Writing a one to these bits will clear the Write Protect bit for the corresponding peripherals.

Value	Description
0	Write-protection is disabled.
1	Write-protection is enabled.

8. Packaging Information

8.1. Thermal Considerations

Related Links

[Junction Temperature](#) on page 39

8.1.1. Thermal Resistance Data

The following *table* summarizes the thermal resistance data depending on the package.

Table 8-1. Thermal Resistance Data

Package Type	θ_{JA}	θ_{JC}
32-pin TQFP	68.0°C/W	25.8°C/W
48-pin TQFP	78.8°C/W	12.3°C/W
64-pin TQFP	66.7°C/W	11.9°C/W
32-pin QFN	37.2°C/W	13.1°C/W
48-pin QFN	33.0°C/W	11.4°C/W
64-pin QFN	33.5°C/W	11.2°C/W
64-ball UFBGA	67.4°C/W	12.4°C/W
45-ball WLCSP	37.0°C/W	0.36°C/W

8.1.2. Junction Temperature

The average chip-junction temperature, T_J , in °C can be obtained from the following:

1. $T_J = T_A + (P_D \times \theta_{JA})$
2. $T_J = T_A + (P_D \times (\theta_{HEATSINK} + \theta_{JC}))$

where:

- θ_{JA} = Package thermal resistance, Junction-to-ambient (°C/W), see Thermal Resistance Data
- θ_{JC} = Package thermal resistance, Junction-to-case thermal resistance (°C/W), see Thermal Resistance Data
- $\theta_{HEATSINK}$ = Thermal resistance (°C/W) specification of the external cooling device
- P_D = Device power consumption (W)
- T_A = Ambient temperature (°C)

From the first equation, the user can derive the estimated lifetime of the chip and decide if a cooling device is necessary or not. If a cooling device is to be fitted on the chip, the second equation should be used to compute the resulting average chip-junction temperature T_J in °C.

Related Links

[Thermal Considerations](#) on page 39

8.2. Package Drawings

8.2.1. 64 pin TQFP



Table 8-2. Device and Package Maximum Weight

300	mg
-----	----

Table 8-3. Package Characteristics

Moisture Sensitivity Level	MSL3
----------------------------	------

Table 8-4. Package Reference

JEDEC Drawing Reference	MS-026
JESD97 Classification	E3

8.2.2. 64 pin QFN

DRAWINGS NOT SCALED

COMMON DIMENSIONS
(Unit of Measure = mm)

SYMBOL	MIN	NOM	MAX	NOTE
A	0.80	-----	1.00	
D/E	9.00 BSC			
D2/E2	4.60	4.70	4.80	
J	0.00	-----	0.05	
b	0.15	0.20	0.25	
e	0.50 BSC			
L	0.30	0.40	0.55	
N	64			

Option A Option B

Pin 1# Chamfer (C 0.35) Pin 1# Notch (0.20 R)

Notes : 1. This drawing is for general information only. Refer to JEDEC Drawing MO-220, Variation VMMD-4, for proper dimensions, tolerances, datums, etc.
2. Dimension b applies to metallized terminal and is measured between 0.15mm and 0.30mm from the terminal tip.
If the terminal has the optical radius on the other end of the terminal, the dimension should not be measured in that radius area.

05/27/2011

Package Drawing Contact: packagedrawings@atmel.com	TITLE	GPC	DRAWING NO.	REV.
	PA, 64 Leads , 0.50 mm plth, 9 x 9 x 1 mm Very Thin Quad Flat No Lead Package (VQFN) Sawn	ZST	PA	A

Note: The exposed die attach pad is not connected electrically inside the device.

Table 8-5. Device and Package Maximum Weight

200	mg
-----	----

Table 8-6. Package Characteristics

Moisture Sensitivity Level	MSL3
----------------------------	------

Table 8-7. Package Reference

JEDEC Drawing Reference	MO-220
JESD97 Classification	E3

8.2.3. 64-ball UFBGA

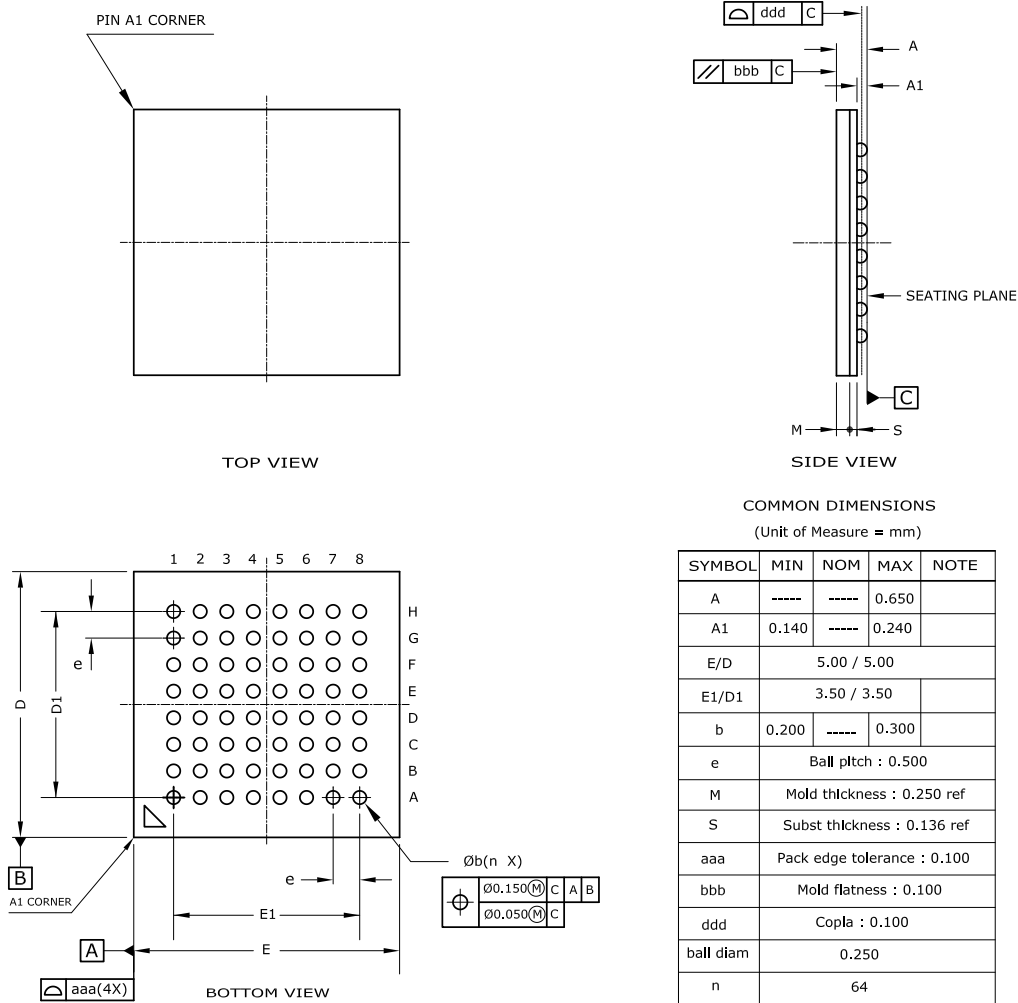

- Notes :
1. This drawing is for general information only. Refer to JEDEC Drawing MO-280, Variation UCCBB for proper dimensions, tolerances, datums, etc.
 2. Array as seen from the bottom of the package.
 3. Dimension A includes stand-off height A1, package body thickness, and lid height, but does not include attached features.
 4. Dimension B is measured at the maximum ball diameter, parallel to primary datum C.

Table 8-8. Device and Package Maximum Weight

27.4	mg
------	----

Table 8-9. Package Characteristics

Moisture Sensitivity Level	MSL3
----------------------------	------

Table 8-10. Package Reference

JEDEC Drawing Reference	MO-220
JESD97 Classification	E8

8.2.4. 48 pin TQFP



Table 8-11. Device and Package Maximum Weight

140	mg
-----	----

Table 8-12. Package Characteristics

Moisture Sensitivity Level	MSL3
----------------------------	------

Table 8-13. Package Reference

JEDEC Drawing Reference	MS-026
JESD97 Classification	E3

8.2.5. 48 pin QFN



Note: The exposed die attach pad is not connected electrically inside the device.

Table 8-14. Device and Package Maximum Weight

140	mg
-----	----

Table 8-15. Package Characteristics

Moisture Sensitivity Level	MSL3
----------------------------	------

Table 8-16. Package Reference

JEDEC Drawing Reference	MO-220
JESD97 Classification	E3

8.2.6. 45-ball WLCSP

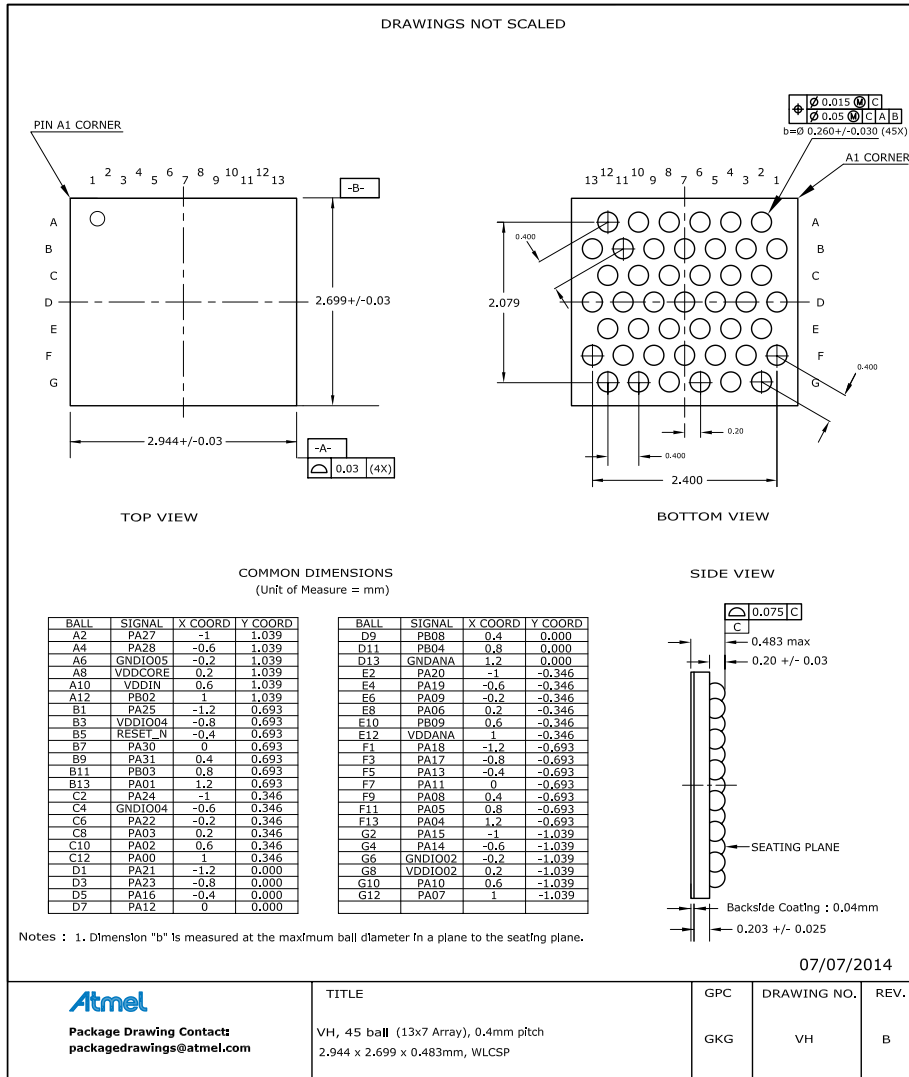

Table 8-17. Device and Package Maximum Weight

7.3	mg
-----	----

Table 8-18. Package Characteristics

Moisture Sensitivity Level	MSL1
----------------------------	------

Table 8-19. Package Reference

JEDEC Drawing Reference	MO-220
JESD97 Classification	E1

8.2.7. 32 pin TQFP



Table 8-20. Device and Package Maximum Weight

100	mg
-----	----

Table 8-21. Package Characteristics

Moisture Sensitivity Level	MSL3
----------------------------	------

Table 8-22. Package Reference

JEDEC Drawing Reference	MS-026
JESD97 Classification	E3

8.2.8. 32 pin QFN



Note: The exposed die attach pad is connected inside the device to GND and GNDANA.

Table 8-23. Device and Package Maximum Weight

90	mg
----	----

Table 8-24. Package Characteristics

Moisture Sensitivity Level	MSL3
----------------------------	------

Table 8-25. Package Reference

JEDEC Drawing Reference	MO-220
JESD97 Classification	E3

8.2.9. 35 ball WLCSP



Table 8-26. Device and Package Maximum Weight

6.2	mg
-----	----

Table 8-27. Package Characteristics

Moisture Sensitivity Level	MSL1
----------------------------	------

Table 8-28. Package Reference

JEDEC Drawing Reference	MO-220
JESD97 Classification	E1

8.3. Soldering Profile

The following table gives the recommended soldering profile from J-STD-20.

Table 8-29.

Profile Feature	Green Package
Average Ramp-up Rate (217°C to peak)	3°C/s max.
Preheat Temperature 175°C ±25°C	150-200°C
Time Maintained Above 217°C	60-150s
Time within 5°C of Actual Peak Temperature	30s
Peak Temperature Range	260°C
Ramp-down Rate	6°C/s max.
Time 25°C to Peak Temperature	8 minutes max.

A maximum of three reflow passes is allowed per component.



Atmel® | Enabling Unlimited Possibilities®



Atmel Corporation 1600 Technology Drive, San Jose, CA 95110 USA T: (+1)(408) 441.0311 F: (+1)(408) 436.4200 | www.atmel.com

© 2016 Atmel Corporation. / Rev.: Atmel-42129P-SAM D20_Datasheet_Summary-09/2016

Atmel®, Atmel logo and combinations thereof, Enabling Unlimited Possibilities®, and others are registered trademarks or trademarks of Atmel Corporation in U.S. and other countries. ARM®, ARM Connected® logo, and others are the registered trademarks or trademarks of ARM Ltd. Other terms and product names may be trademarks of others.

DISCLAIMER: The information in this document is provided in connection with Atmel products. No license, express or implied, by estoppel or otherwise, to any intellectual property right is granted by this document or in connection with the sale of Atmel products. EXCEPT AS SET FORTH IN THE ATMEL TERMS AND CONDITIONS OF SALES LOCATED ON THE ATMEL WEBSITE, ATMEL ASSUMES NO LIABILITY WHATSOEVER AND DISCLAIMS ANY EXPRESS, IMPLIED OR STATUTORY WARRANTY RELATING TO ITS PRODUCTS INCLUDING, BUT NOT LIMITED TO, THE IMPLIED WARRANTY OF MERCHANTABILITY, FITNESS FOR A PARTICULAR PURPOSE, OR NON-INFRINGEMENT. IN NO EVENT SHALL ATMEL BE LIABLE FOR ANY DIRECT, INDIRECT, CONSEQUENTIAL, PUNITIVE, SPECIAL OR INCIDENTAL DAMAGES (INCLUDING, WITHOUT LIMITATION, DAMAGES FOR LOSS AND PROFITS, BUSINESS INTERRUPTION, OR LOSS OF INFORMATION) ARISING OUT OF THE USE OR INABILITY TO USE THIS DOCUMENT, EVEN IF ATMEL HAS BEEN ADVISED OF THE POSSIBILITY OF SUCH DAMAGES. Atmel makes no representations or warranties with respect to the accuracy or completeness of the contents of this document and reserves the right to make changes to specifications and products descriptions at any time without notice. Atmel does not make any commitment to update the information contained herein. Unless specifically provided otherwise, Atmel products are not suitable for, and shall not be used in, automotive applications. Atmel products are not intended, authorized, or warranted for use as components in applications intended to support or sustain life.

SAFETY-CRITICAL, MILITARY, AND AUTOMOTIVE APPLICATIONS DISCLAIMER: Atmel products are not designed for and will not be used in connection with any applications where the failure of such products would reasonably be expected to result in significant personal injury or death ("Safety-Critical Applications") without an Atmel officer's specific written consent. Safety-Critical Applications include, without limitation, life support devices and systems, equipment or systems for the operation of nuclear facilities and weapons systems. Atmel products are not designed nor intended for use in military or aerospace applications or environments unless specifically designated by Atmel as military-grade. Atmel products are not designed nor intended for use in automotive applications unless specifically designated by Atmel as automotive-grade.