

Dear customer

LAPIS Semiconductor Co., Ltd. ("LAPIS Semiconductor"), on the 1st day of October, 2020, implemented the incorporation-type company split (shinsetsu-bunkatsu) in which LAPIS established a new company, LAPIS Technology Co., Ltd. ("LAPIS Technology") and LAPIS Technology succeeded LAPIS Semiconductor's LSI business.

Therefore, all references to "LAPIS Semiconductor Co., Ltd.", "LAPIS Semiconductor" and/or "LAPIS" in this document shall be replaced with "LAPIS Technology Co., Ltd."

Furthermore, there are no changes to the documents relating to our products other than the company name, the company trademark, logo, etc.

Thank you for your understanding.

LAPIS Technology Co., Ltd.
October 1, 2020

ML62Q1700 Group

16-bit micro controller

GENERAL DESCRIPTION

ML62Q1700 Group is a high performance CMOS 16-bit microcontroller equipped with an 16-bit CPU nX-U16/100 and integrated with program memory(Flash memory), data memory(RAM), data Flash and rich peripheral functions such as the multiplier/divider, CRC operator, DMA controller, clock generator, Simplified RTC, timer, UART, synchronous serial port, I²C bus interface unit, buzzer, Voltage Level Supervisor(VLS), successive approximation type A/D converter, D/A converter, analog comparator, LCD driver, safety function(IEC60730/60335 Class B) and etc.

The CPU nX-U16/100 is capable of efficient instruction execution in 1-instruction 1-clock mode by pipeline architecture parallel processing.

The built-in on-chip debug function enables debugging and programming the software. Also, ISP(In-System Programming) function supports the Flash programming in production line.

The ML62Q1700 Group has seven packages (48pin - 100pin) and ten kinds of memory sizes(32Kbyte - 512Kbyte).

Table 1 ML62Q1700 Group Product List

Program memory	Data memory (RAM)	Data Flash	48pin TQFP48	52pin TQFP52	64pin QFP64 TQFP64	80pin QFP80	100pin QFP100 TQFP100
512Kbyte	32Kbyte	8Kbyte	—	—	ML62Q1729	ML62Q1739	ML62Q1749
384Kbyte			—	—	ML62Q1728	ML62Q1738	ML62Q1748
256Kbyte	16Kbyte	4Kbyte	—	—	ML62Q1727	ML62Q1737	ML62Q1747
192Kbyte			—	—	ML62Q1726	ML62Q1736	ML62Q1746
160Kbyte			—	—	ML62Q1725	ML62Q1735	ML62Q1745
128Kbyte			16Kbyte	—	—	—	ML62Q1734
	8Kbyte		ML62Q1704	ML62Q1714	ML62Q1724	—	—
96Kbyte	16Kbyte		—	—	—	ML62Q1733	ML62Q1743
	8Kbyte		ML62Q1703	ML62Q1713	ML62Q1723	—	—
64Kbyte	8Kbyte		ML62Q1702	ML62Q1712	ML62Q1722	—	—
48Kbyte			ML62Q1701	ML62Q1711	ML62Q1721	—	—
32Kbyte			ML62Q1700	ML62Q1710	ML62Q1720	—	—

FEATURES

- CPU
 - 16-bit RISC CPU
 - Instruction system: 16-bit length instruction
 - Instruction set: Transfer, arithmetic operations, comparison, logic operations, multiplication/division, bit manipulations, bit logic operations, jump, conditional jump, call return stack manipulations, arithmetic shift, and so on
 - On-chip debug function built-in (supported by LAPIS on-chip debug emulator EASE1000)
 - ISP (In-System Programming) function built-in
 - Minimum instruction execution time
 - 30.5 μs (at 32.768 kHz system clock)
 - 62.5ns/41.6ns (at 16 MHz/24MHz system clock)

- Coprocessor for multiplication and division
 - Multiplication: 16bit × 16bit (operation time 4 cycles)
 - Division: 32bit / 16bit (operation time 8 cycles)
 - Division: 32bit / 32bit (operation time 16 cycles)
 - Multiply-accumulate (non-saturating): 16bit × 16bit + 32bit (operation time 4 cycles)
 - Multiply-accumulate (saturating): 16bit × 16bit + 32bit (operation time 4 cycles)
- Operating voltage and temperature
 - Operating voltage: VDD = 1.6 to 5.5 V (Need 1.8V or higher at the power on)
 - Operating temperature: -40 to +105 °C
- Internal memory
 - Program Flash memory area
 - Rewrite count: 100 cycles
 - Rewrite unit: 32bit(4byte)
 - Erase unit: 16Kbyte/1Kbyte
 - Erase/Rewrite temperature: 0°C to +40°C
 - Data Flash memory area
 - Rewrite count 10,000 cycles
 - Rewrite unit: 8bit(1byte)
 - Erase unit: all area/128byte
 - Erase/Rewrite temperature: -40°C to +85°C
 - Back Ground Operation(BGO) : CPU can work while erasing and rewriting.

This product uses Super Flash® technology licensed from Silicon Storage Technology, Inc.
Super Flash® is a registered trademark of Silicon Storage Technology, Inc.
 - Data RAM area
 - Rewrite unit: 8bit/16bit(1byte/2byte)
 - Parity check function (Parity error reset or interrupt is generatable)
- Clock
 - Low-speed clock
 - Internal low-speed RC oscillation: Approx.32.768 kHz
 - External low-speed crystal oscillation: 32.768 kHz crystal resonator is connectable
 - 3 modes is available for the crystal oscillation
 - Tough mode: Largest oscillation allowance to make highest resistance against leakage between the pins
 - Standard mode: Standard oscillation allowance and current consumption
 - Low power current mode: Smaller oscillation allowance than standard mode to make lower current consumption
 - High-speed clock
 - PLL oscillation: 24MHz/16MHz is selectable by code option
 - WDT(Watch Dog Timer) clock
 - Internal low-speed RC oscillation: Approx. 1kHz
 - The WDT independent clock or the divided clock of internal low-speed clock is selectable by the code option.
- Reset
 - RESET_N pin reset
 - Reset by power-on detection
 - Reset by the 2nd watchdog timer (WDT) overflow
 - Reset by WDT counter clear during the clear invalid period
 - Reset by RAM parity error
 - Reset by unused ROM access
 - Reset by voltage level detection (VLS)
 - The software reset by BRK instruction (reset CPU only)
 - Reset to the peripheral circuits by Block Reset Control Registers (BRECON 0 to 3)
 - One-time reset to the all peripheral circuits by Software Reset Control Register (SOFTRCON)

- Power management
 - HALT mode: CPU stops executing instruction, clock oscillations and peripheral circuits remain previous states
 - HALT-H mode: CPU stops executing instruction, high-speed clock oscillation stops and peripheral circuits working with low-speed clock remain previous states
 - STOP mode: CPU stops executing instruction, both high-speed oscillation and low-speed oscillation stop.
 - STOP-D mode: CPU stops executing instruction, both high-speed oscillation and low-speed oscillation stop. The internal regulator's output voltage (V_{DDL}) goes down to reduce the current consumption.
 - Clock gear: The frequency of high-speed system clock can be changed by software (1/1, 1/2, 1/4, 1/8, 1/16 or 1/32 of the oscillation clock)
 - Block Control Function: Powers down the circuits of unused function blocks (reset the block or stop supplying the clock)
- Interrupt controller
 - Non-maskable interrupt source: 1 (Internal sources: WDT)
 - Maskable interrupt sources: max.51 (Internal sources: max.42, External sources: 9)
 - Four step interrupt levels
 - External interrupt ports : max 12
- Watchdog timer(WDT)
 - Operating clock is selectable (1kHz WDT independent clock or divided clock of internal 32.768kHz RC oscillation)
 - Overflow period: 8 types selectable (7.8ms, 15.6ms, 31.3ms, 62.5ms, 125ms, 500ms, 2000ms and 8000ms@32.768kHz)
 - Enabling or disabling the window function is selectable (The clear enable period is 50% or 75% of overflow period)
 - WDT operation is selectable by code option (Enable or Disable)
 - Readable WDT counter (WDT counter monitor function)
 - The first overflow generates the WDT interrupt, and the second overflow generates the WDT reset when the counter clear enable period is 100% of overflow period.
 - The first overflow generates the WDT reset when the counter clear enable period is 50% or 75% of overflow period.
 - The invalid clear reset generated when the WDT counter is cleared out of the WDT counter clear enable period.
- DMA(Direct Memory Access) controller
 - Channel: 2ch
 - Transfer unit: 8bit/16bit
 - Max. transfer count: 1024 time
 - Transfer type: 2 cycle transfer
 - Transfer mode: Single transfer mode
Fixed address, address increments and address decrements
 - Transfer target: SFR/RAM → SFR/RAM (Transfer from/to Flash is not supported)
 - Transfer request: Serial communication units, A/D, 16-bit timers, Functional timers and External interrupts.
- Low-speed Time base counter
 - Divide the Low-speed clock(LSCLK) and generate 128Hz~1Hz internal pulse signals
 - Periodical interrupt × 3 selectable from 8 frequencies (128Hz, 64Hz, 32Hz, 16Hz, 8Hz, 4Hz, 2Hz and 1Hz)
 - The time base clock output (1Hz or 2Hz) from general purpose ports (TBCOUT0, TBCOUT1).
 - Built-in frequency adjustment function
(adjustment range: approx.-488ppm ~ +488ppm, adjustment resolution: approx.0.119ppm)
- Simplified RTC
 - Channel: 1ch
 - Count by one second from “00 min. 00 sec” to “59 min. 59 sec”
 - One interrupt occurrence is selectable from four periodical interrupt requests (0.5sec, 1sec, 30sec or 60sec)
 - Protect function for incorrect writing the minutes and second.

- Functional timer (FTM)
 - Channel: Max. 8ch
 - Trigger source: Capture mode, PWM mode1 and PWM mode 2 (complementary output)
 - Same start/stop is available with different channels
(This function is not available with 16-bit timer)
 - Event trigger (external interrupts, analog comparators, 16-bit timers and Functional timers)
 - Decrement counter (available with 16-bit timer)
 - Available to specify division ratio of counter clock channel by channel

- 16-bit timers
 - Channel: Max. 8ch
 - 8-bit timer mode and 16-bit timer mode (1ch 16-bit timer is configurable as 2ch 8-bit timer)
 - Same start/stop is available with different channels
(This function is not available with Functional Timer)
 - Timer output (toggled by overflow)
 - Available to specify division ratio of counter clock channel by channel

- Serial communication unit
 - Channel: Max. 6ch
 - Synchronous Serial Port or UART is selectable in each channel

< Synchronous Serial Port >

- Master/slave selectable
- LSB first/MSB first selectable
- 8-bit length/16-bit length selectable

< UART >

- Full-duplex communication x 2ch (One Full-duplex UART is configurable as two half-duplex UARTs)
- 5~8 bit length, parity/no parity, odd parity/even parity, 1 stop bit/2 stop bits
- Positive logic/negative logic selectable
- LSB first/MSB first selectable
- Wide range of communication speed
 - 32.768kHz operation clock : 1bps to 4,800bps
 - 24MHz operation clock : 600bps to 3Mbps
 - 16MHz operation clock : 300bps to 2Mbps
- Internal baud rate generator

- I²C bus interface unit (Master/Slave)
 - Channel: 1ch
 - Master or Slave mode is selectable

< Master function >

- Standard mode (100 kbit/s), fast mode (400 kbit/s) and 1Mbps mode (1Mbit/s)
- Handshake (Clock synchronization)
- 7bit address format (10bit address format is supported)

< Slave function >

- Standard mode (100 kbit/s), fast mode (400 kbit/s) and 1Mbps mode (1Mbit/s)
- Clock stretch function
- 7bit address format

- I²C bus interface (Master only)
 - Channel: 2ch
 - Standard mode (100 kbit/s), fast mode (400 kbit/s) and 1Mbps mode (1Mbit/s)
 - Handshake (Clock synchronization)
 - 7bit address format (10bit address format is supported)

- General-purpose ports (GPIO)
 - I/O port: Max. 87 (Including one pin for on-chip debug and pins for other shared functions)
 - Input port: Max. 2(Including a shared function)
 - External interrupt function × 12
 - LED driver port : Max. 86
 - Carrier frequency output function (used for IR communication)
- Successive approximation type A/D converter
 - Channel: Max.16ch
 - Resolution: 10bit
 - Conversion time: Selectable 2.25μs (min) /channel (When the conversion clock is 8MHz)
 - V_{DD}, Internal reference voltage(Approx. 1.55V) or External reference voltage (V_{REF} pin) is selectable.
 - Scan function (repeat conversion)
 - One result register for each channel
 - Interrupt by threshold of conversion result
 - Temperature sensor for low-speed RC oscillation adjustment
- Voltage level supervisor (VLS)
 - Accuracy: ±4%
 - Threshold voltage: 12 values selectable (1.85V ~ 4.00V)
 - Voltage level detection reset (VLS reset)
 - Voltage level detection interrupt (VLS0 interrupt)
- Analog comparator
 - Channel: 2ch
 - Interrupts allow edge selection and sampling selection
 - An external or an internal reference voltage is selectable
- D/A converter
 - Channel: Max 2ch
 - Resolution: 8bit
 - Output impedance: 6k ohm(Typ.)
 - R-2R ladder method
- Buzzer
 - 4 buzzer mode (Repeat sound, Single sound, Intermittent sound 1 and Intermittent sound 2)
 - 8frequencies (4.096kHz to 293Hz)
 - 15 step duty (1/16 to 15/16)
 - Selectable the logic of buzzer output pin (Positive or Negative logic)
- CRC(Cyclic Redundancy Check) operation function
 - Generation equation: $X^{16}+X^{12}+X^5+1$
 - LSB first or MSB first is selectable
 - Automatic CRC mode: Automatic CRC calculation with data of program memory in HALT mode
- LCD driver
 - Max. 480 dots (60seg x 8 com) *1

ML62Q1700/1701/1702/1703/1704:	24seg×8com (com Max.), 29seg×3com (seg Max.)
ML62Q1710/1711/1712/1713/1714:	27seg×8com (com Max.), 32seg×3com (seg Max.)
ML62Q1720/1721/1722/1723/1724/ 1725/1726/1727/1728/1729:	35seg×8com (com Max.), 40seg×3com (seg Max.)
ML62Q1733/1734/1735/1736/1737/1738/1739:	45seg×8com (com Max.), 50seg×3com (seg Max.)
ML62Q1743/1744/1745/1746/1747/1748/1749:	60seg×8com (com Max.), 65seg×3com (seg Max.)
 - *1 : Five pins are shared for common or segment, selectable by setting a SFR
 - 1/3 bias (built-in bias generation circuit)
 - Frame frequency (Approx. 32Hz, 38Hz, 64Hz, 75Hz, 128Hz and 150Hz)
 - Four bias generation modes (Internal voltage boost, Internal capacitive voltage divide, External supply voltage/capacitive divide, and External supply voltages)
 - Contrast adjustment (32 steps) is available in the Internal voltage boost mode.

- Safety Function (IEC60730/60335 Class B)
 - Automatic switch to the low-speed RC oscillation
 - RAM/SFR guard
 - Automatic CRC calculation with data of program memory
 - RAM parity error detection
 - ROM unused area access reset
 - Clock mutual check
 - WDT counter check
 - Successive approximation type A/D converter test
 - UART test
 - Synchronous serial test
 - I²C test
 - General port test

- Shipping package
 - 48-pin plastic TQFP
ML62Q1700/1701/1702/1703/1704 - xxxTB
(Blank part: ML62Q1700/1701/1702/1703/1704-NNNTB)
 - 52-pin plastic TQFP
ML62Q1710/1711/1712/1713/1714 - xxxTB
(Blank part: ML62Q1710/1711/1712/1713/1714-NNNTB)
 - 64-pin plastic TQFP
ML62Q1720/1721/1722/1723/1724/1725/1726/1727/1728/1729 - xxxTB
(Blank part: ML62Q1720/1721/1722/1723/1724/1725/1726/1727/1728/1729-NNNTB)
 - 64-pin plastic QFP
ML62Q1720/1721/1722/1723/1724/1725/1726/1727/1728/1729 - xxxGA
(Blank part: ML62Q1720/1721/1722/1723/1724/1725/1726/1727/1728/1729-NNNGA)
 - 80-pin plastic QFP
ML62Q1733/1734/1735/1736/1737/1738/1739 - xxxGA
(Blank part: ML62Q1733/1734/1735/1736/1737/1738/1739-NNNGA)
 - 100-pin plastic TQFP
ML62Q1743/1744/1745/1746/1747/1748/1749 - xxxTB
(Blank part: ML62Q1743/1744/1745/1746/1747/1748/1749-NNNTB)
 - 100-pin plastic QFP
ML62Q1743/1744/1745/1746/1747/1748/1749 - xxxGA
(Blank part: ML62Q1743/1744/1745/1746/1747/1748/1749-NNNGA)

xxx: ROM code number

ML62Q1700 Group how to read the part number

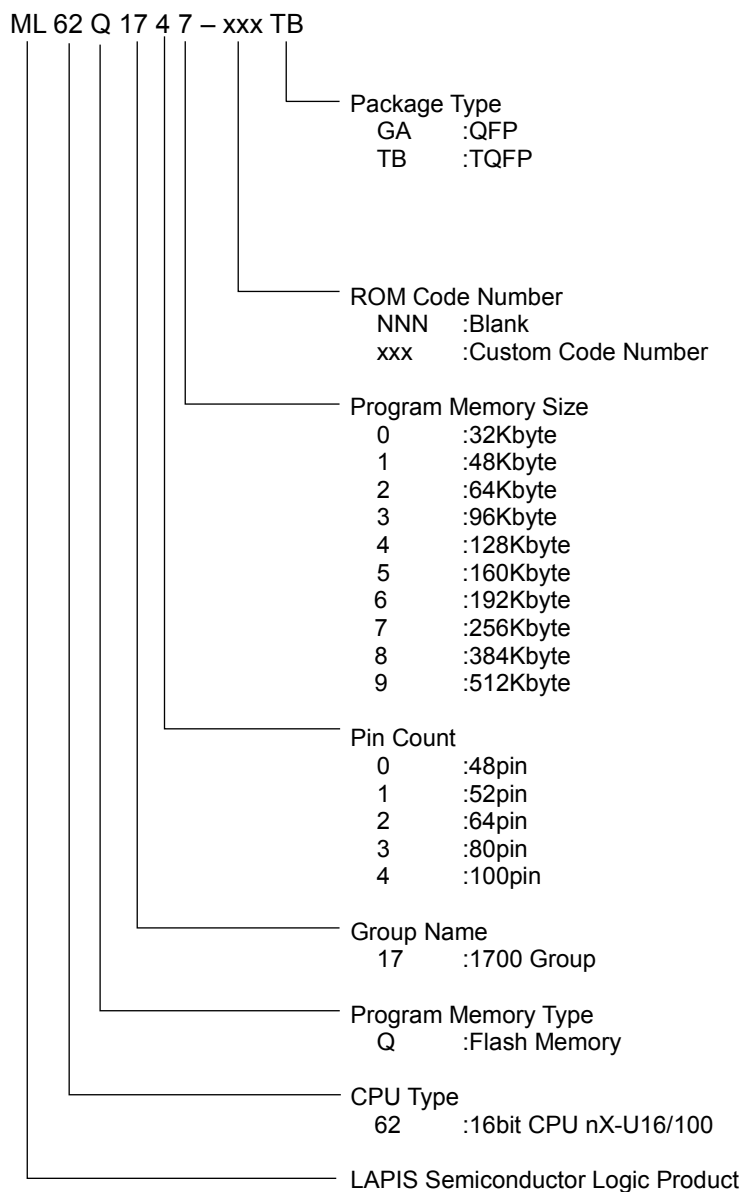

Figure 1 ML62Q1700 Group Part Number

ML62Q1700 Group Main Function List

Table 2 ML62Q1700 Group Main Function List

Part number	Pin				LCD drive pin		Interrupt		Timer		Serial		Analog										
	Total pin-counts	Power pin counts	Reset Input pin	Input port * ³	I/O port	LED drive port	LCD common/segment shared pin * ^{4,5}	LCD segment pin * ⁵	LCD bias pin	Internal interrupt [source]	External interrupt [port]	Functional Timer [ch]	16-bit Timer [ch] * ¹	Simplified RTC [ch]	Full-duplex UART or Synchronous serial [ch] * ²	I ² C bus unit (Master/Slave) [ch]	I ² C bus interface (Master only) [ch]	10bit Successive type A/D converter [ch]	Analog comparator [ch]	Analog comparator [input pin]	8bit D/A converter [ch]		
ML62Q1700	48	3			37	36		24															
ML62Q1701																							
ML62Q1702																							
ML62Q1703																							
ML62Q1704	52				41	40		27															
ML62Q1710																							
ML62Q1711																							
ML62Q1712																							
ML62Q1713	64				53	52		35	31	10	6	6		2									
ML62Q1714																							
ML62Q1720																							
ML62Q1721																							
ML62Q1722	64	1	2		53	52	5	3	5				1		1	2							
ML62Q1723																							
ML62Q1724																							
ML62Q1725																							
ML62Q1726	80				53	52	5	3	5														
ML62Q1727																							
ML62Q1728																							
ML62Q1729																							
ML62Q1733	80				67	66		45															
ML62Q1734																							
ML62Q1735																							
ML62Q1736																							
ML62Q1737	100	4			67	66		45	43	12	8	8		6									
ML62Q1738																							
ML62Q1739																							
ML62Q1743																							
ML62Q1744	100				87	86		60															
ML62Q1745																							
ML62Q1746																							
ML62Q1747																							
ML62Q1748																							
ML62Q1749																							

*¹: One 16bit timer is configurable as two 8bit timers

*²: Full-duplex UART and Synchronous Serial Port can not be used simultaneously in the same channel.
One Full-duplex UART is configurable as two half-duplex UARTs.

*³: Shared with pins for crystal oscillation

*⁴: The LCD common/segment shared pins are shared for common or segment, selectable by setting a SFR

*⁵: All LCD drive pins are shared with general purpose I/O ports.

BLOCK DIAGRAM

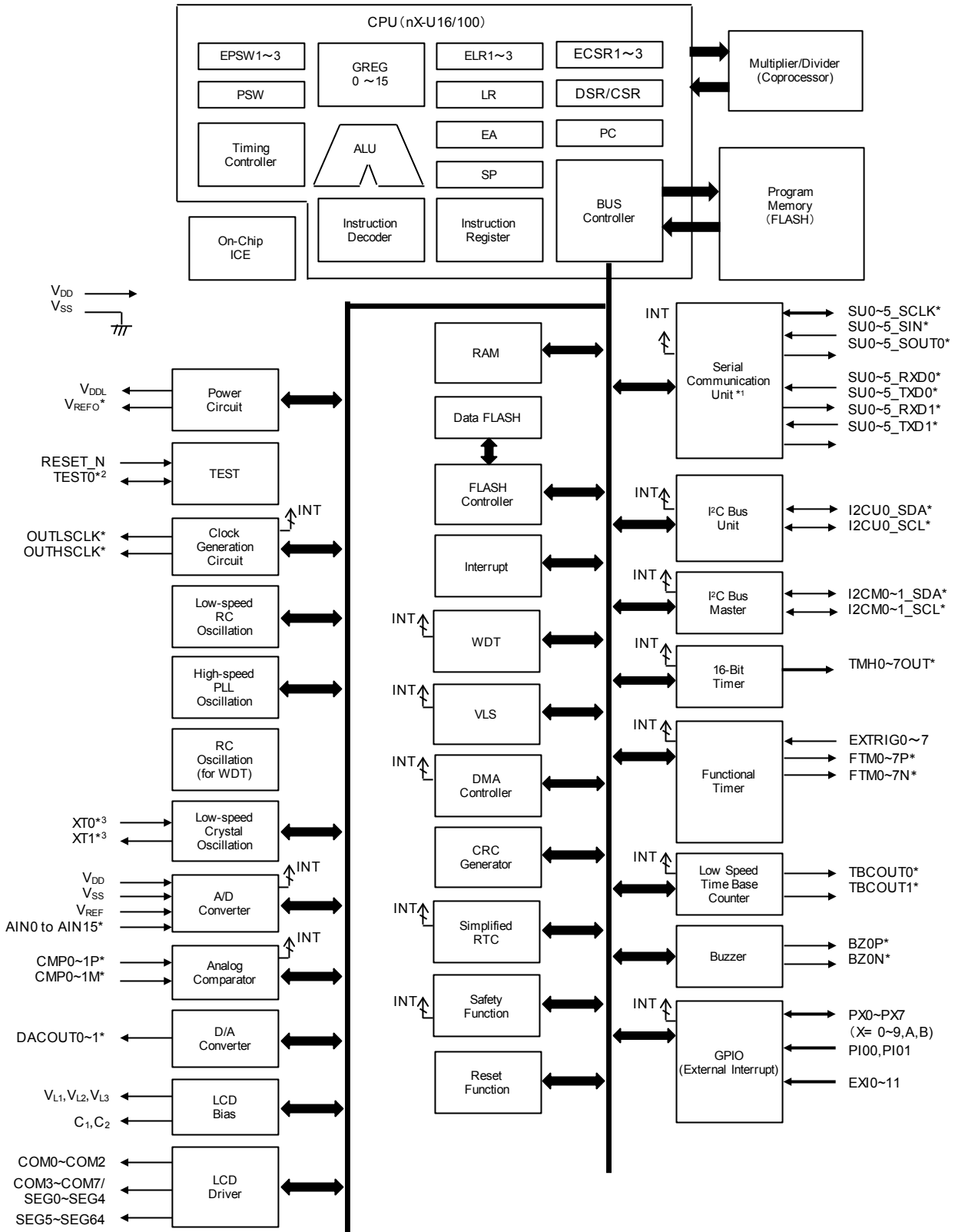

* : Indicates the shared function of general ports.
 *¹ : One channel Full-duplex UART is configurable as two channel Half-duplex UART.
 *² : Not available as the input port when connecting to the on-chip debug emulator(EASE1000).
 *³ : Not available as the input port when connecting to the crystal resonator.

Figure 2 ML62Q1700 Group Block Diagram

PIN CONFIGURATION

The pin names in the pin-layout indicate 1st-function or LCD function. Refer to Table-3 or Table-4 about other functions.

Pin Layout of 48pin TQFP Package

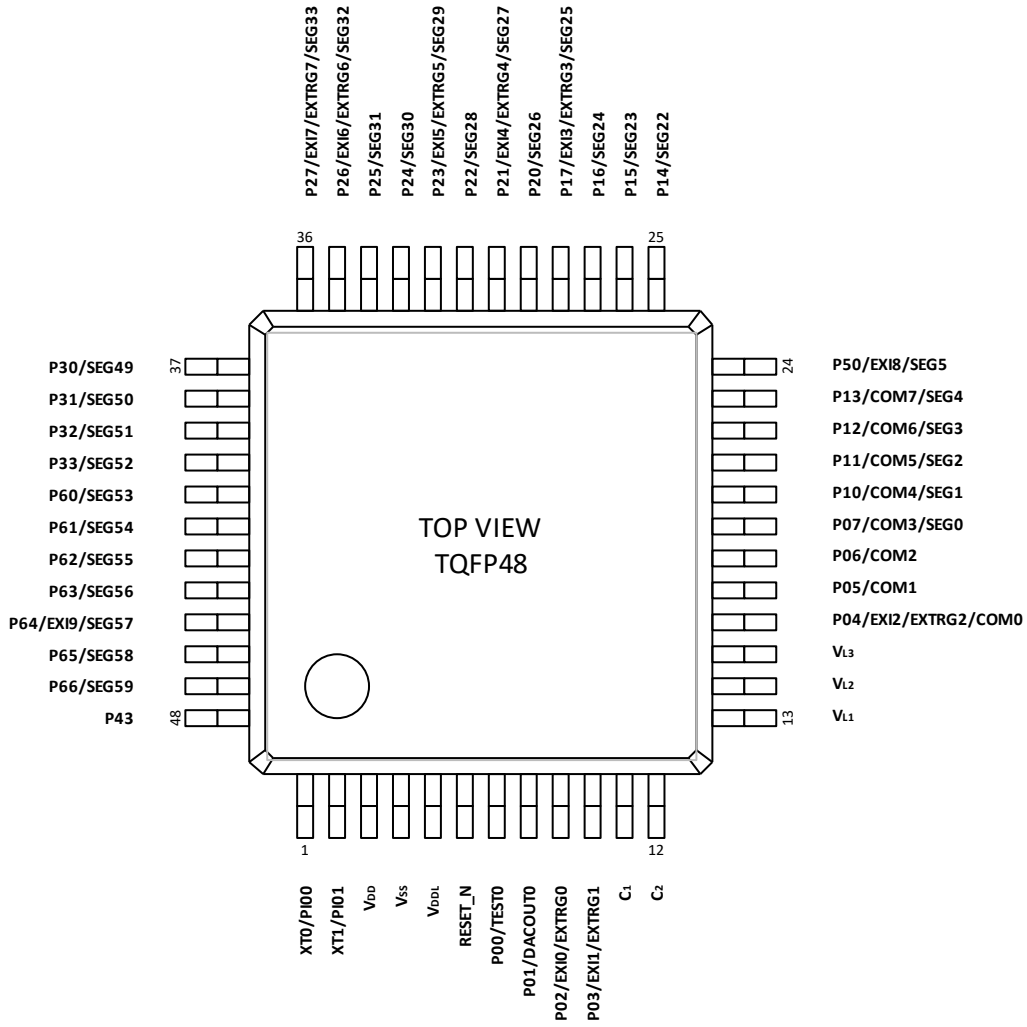

Figure 3 Pin Layout of 48pin TQFP Package

Pin Layout of 52pin TQFP Package

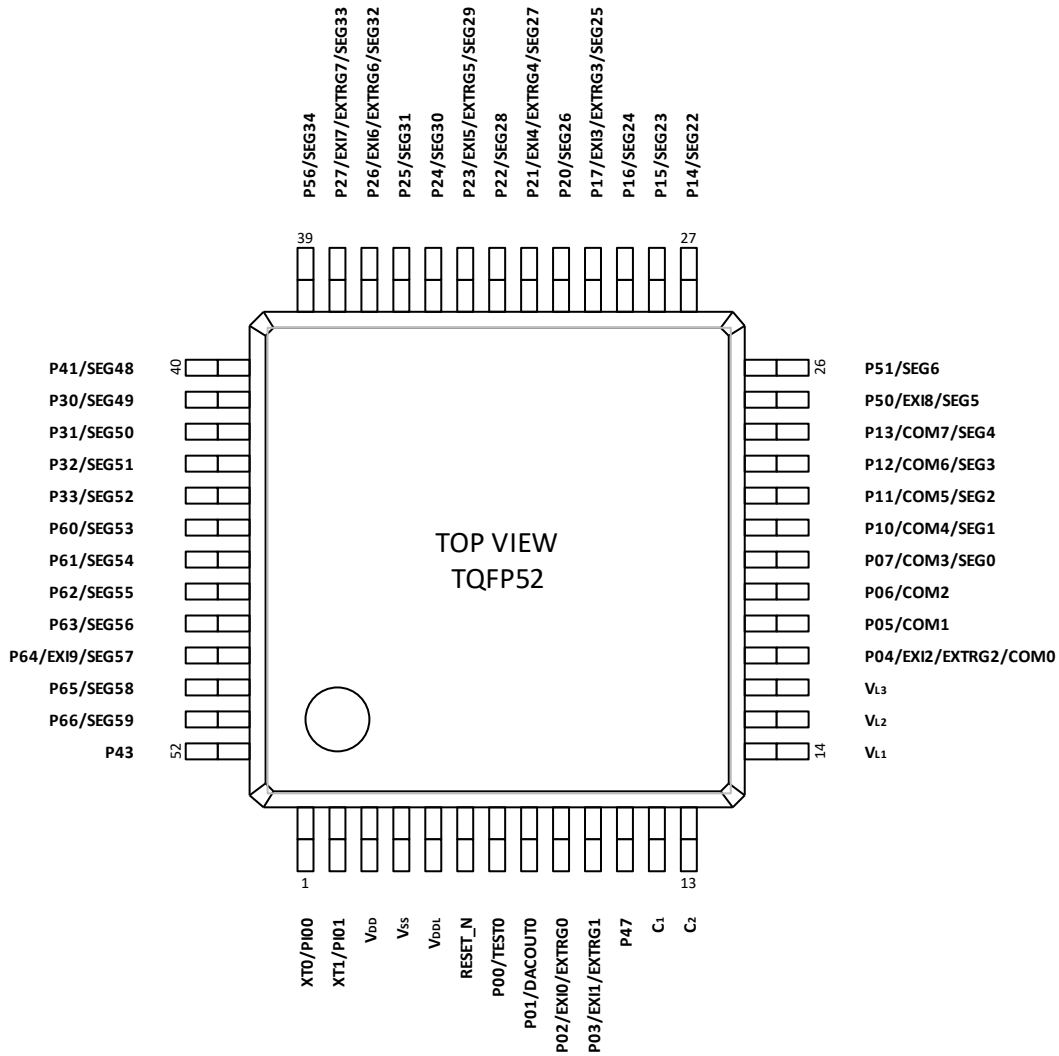

Figure 4 Pin Layout of 52pin TQFP52 Package

Pin Layout of 64pin TQFP/QFP Package

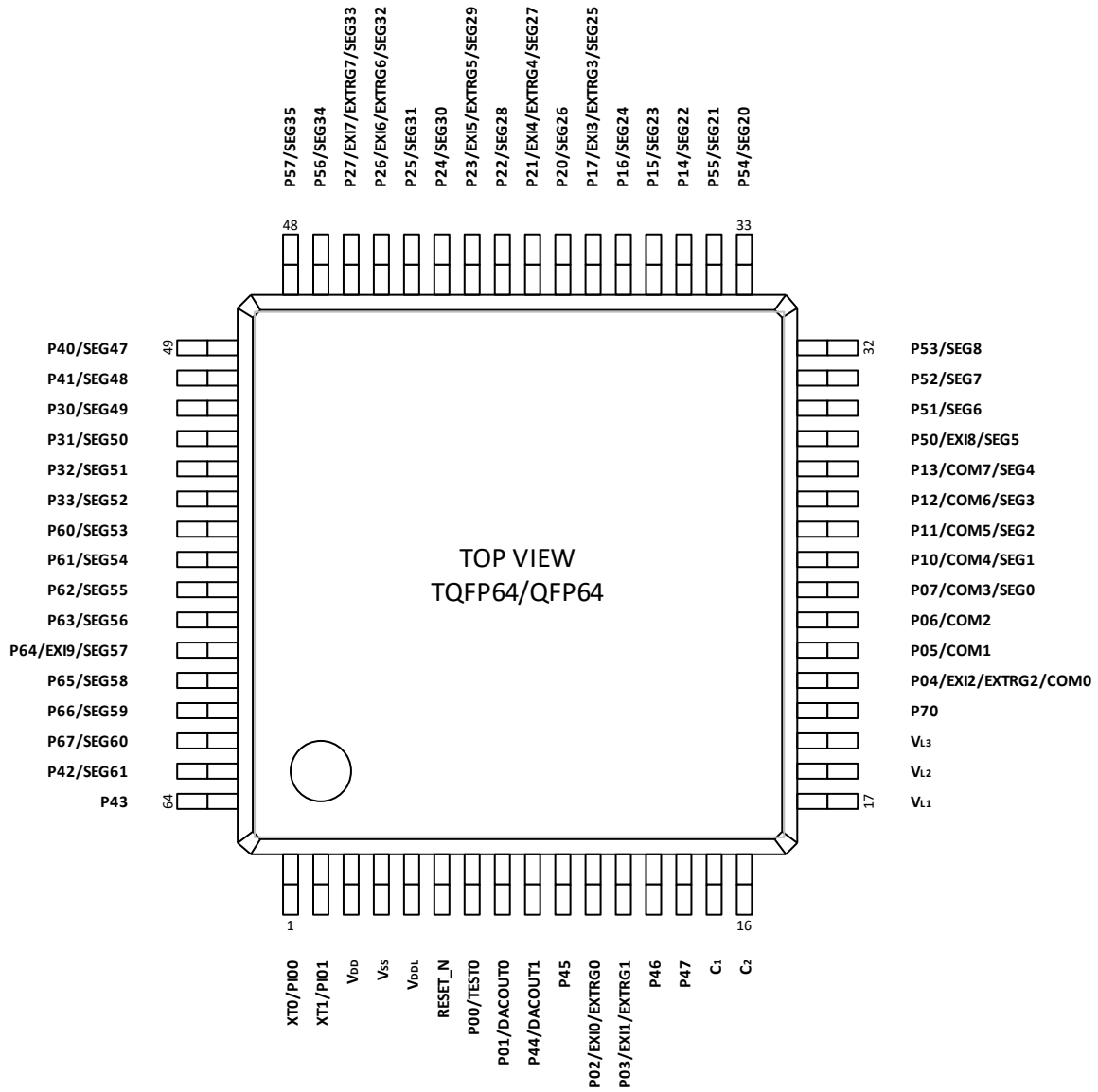

Figure 5 Pin Layout of 64pin TQFP/QFP Package

Pin Layout of 80pin QFP Package

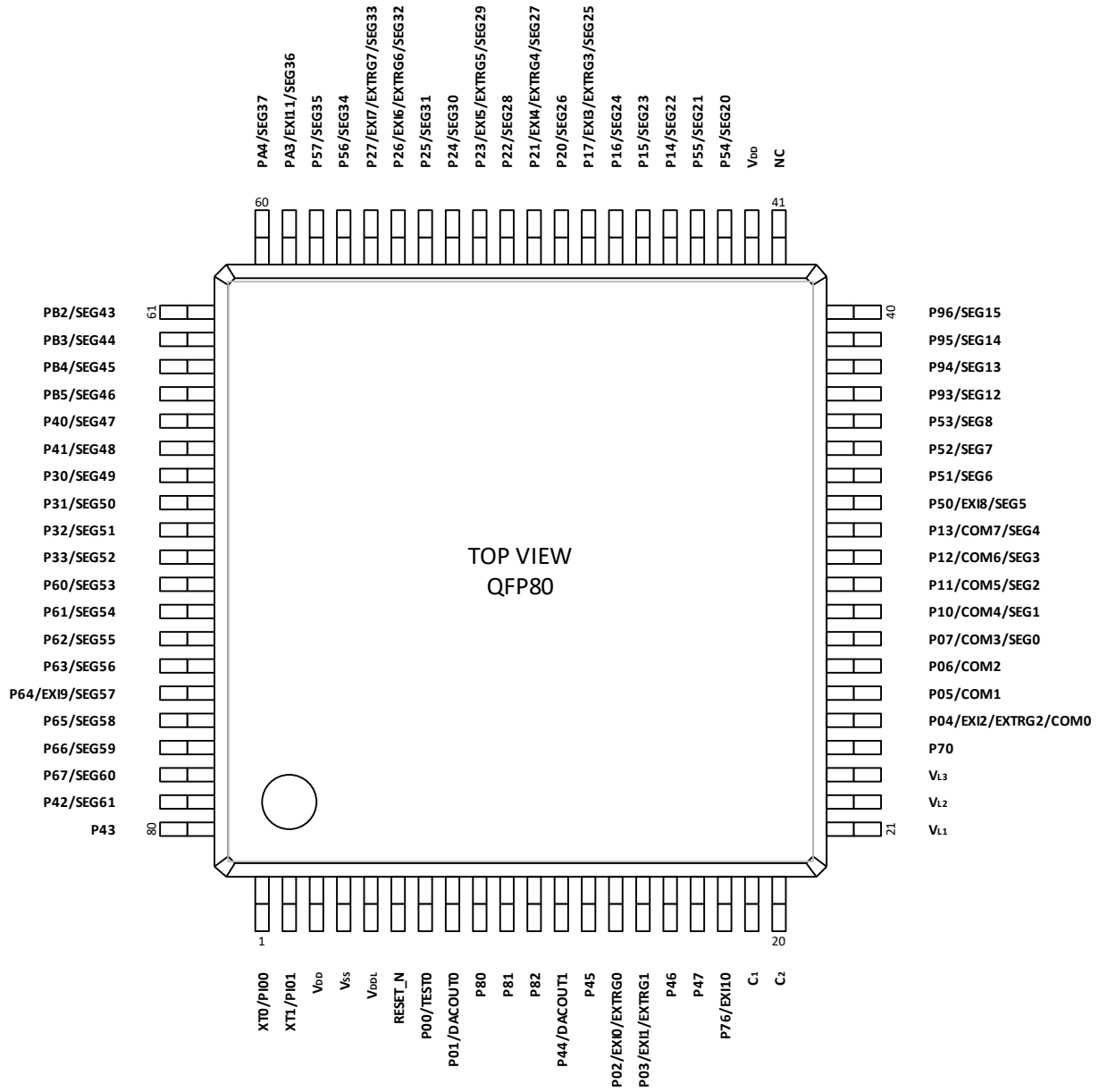

Figure 6 Pin Layout of 80pin QFP Package

Pin Layout of 100pin TQFP Package

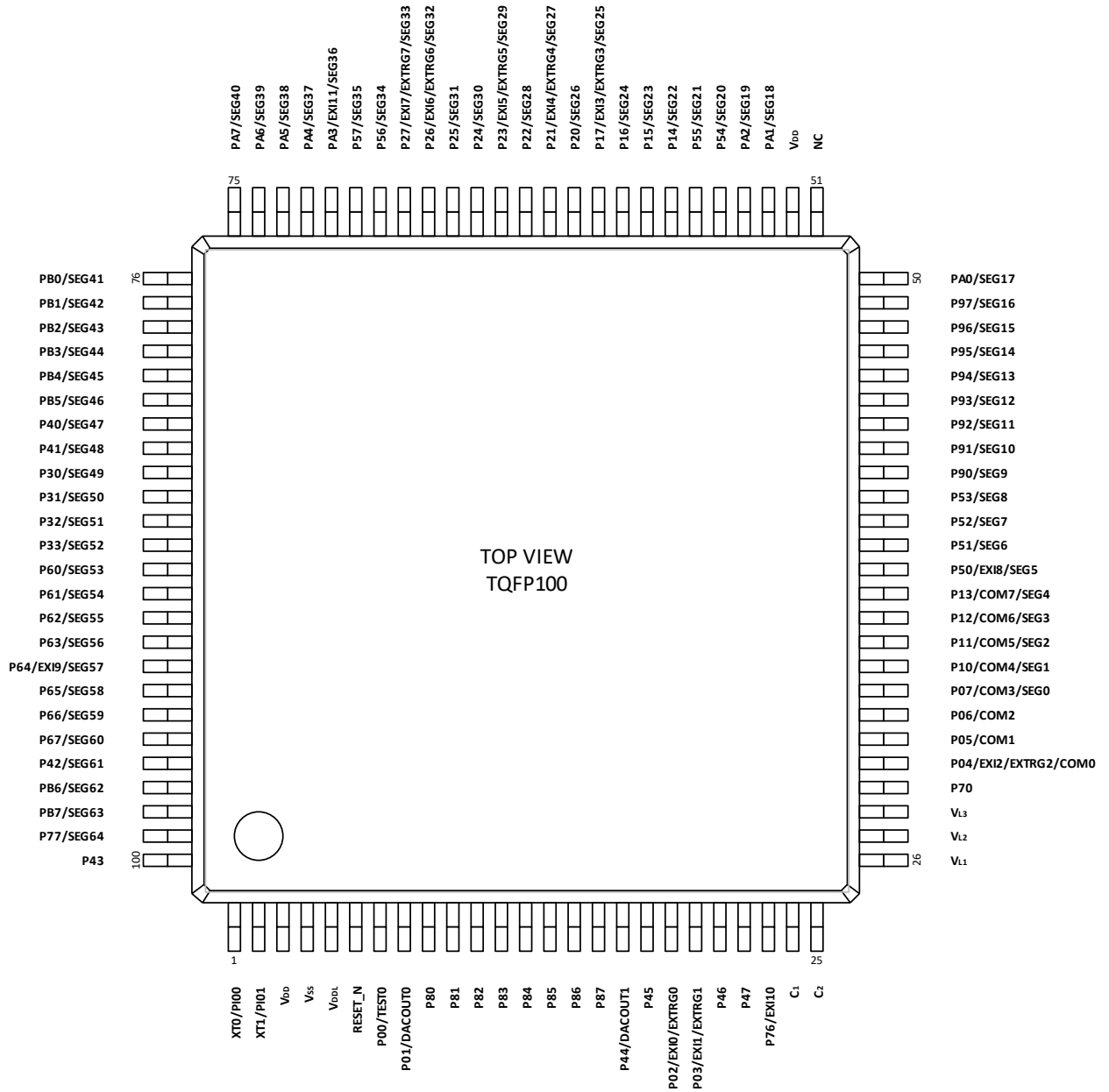

Figure 7 Pin Layout of 100pin TQFP Package

Pin Layout of 100pin QFP Package

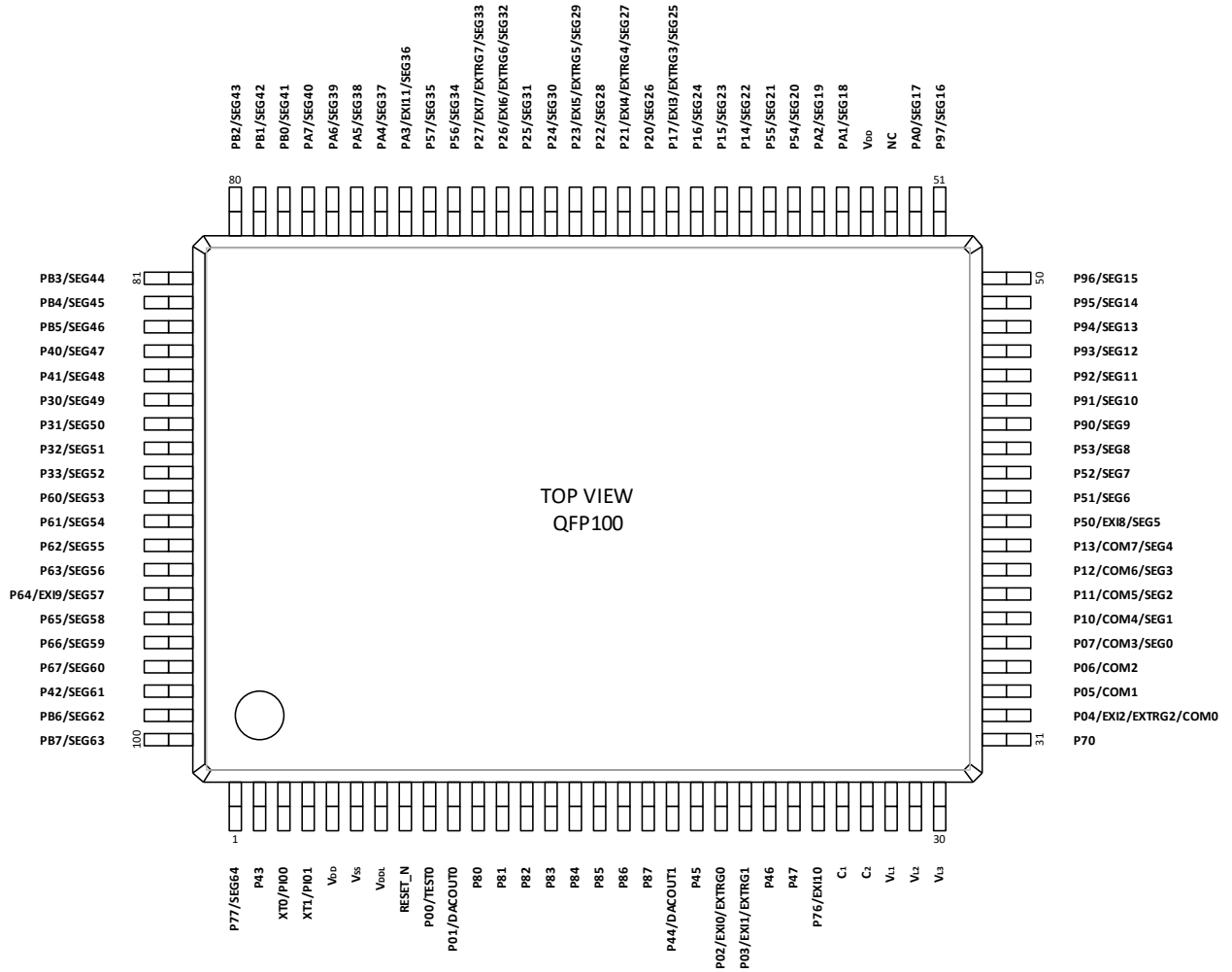

Figure 8 Pin Layout of 100pin QFP Package

PIN LIST

Table 3 Pin List (1/3)

Pin No.						Pin name (1 st func.)	1 st func. others	2 nd func. SIU	3 rd func. SIU	4 th func. I2C	5 th func. Timer	6 th func. others	7 th func. others	8 th func. ADC
48 Pin	52 Pin	64 Pin	80 pin	TOFP100	QFP100									
3	3	3	3	3	5	V _{DD}	-	-	-	-	-	-	-	-
-	-	-	42	52	54	V _{DD}	-	-	-	-	-	-	-	-
4	4	4	4	4	6	V _{SS}	-	-	-	-	-	-	-	-
-	-	-	41	51	53	NC	-	-	-	-	-	-	-	-
5	5	5	5	5	7	V _{DDL}	-	-	-	-	-	-	-	-
1	1	1	1	1	3	XT0	PI00	-	-	-	-	-	-	-
2	2	2	2	2	4	XT1	PI01	-	-	-	-	-	-	-
6	6	6	6	6	8	RESET_N	RESET_N	-	-	-	-	-	-	-
7	7	7	7	7	9	P00	TEST0	-	-	-	-	-	-	-
8	8	8	8	8	10	P01	DACOUT0	-	-	-	FTM3P*1	TBCOUT0	TBCOUT1	-
9	9	11	14	19	21	P02	EXI0 EXTRG0	SU0_RXD0 SU0_SIN	-	I2CU0_SCL*1	FTM0P	OUTLSCLK	CMP0M	-
10	10	12	15	20	22	P03	EXI1 EXTRG1	SU0_TXD0 SU0_SOUT	SU0_TXD1	I2CU0_SDA	FTM0N	OUTHCLK	CMP0P	AIN11
16	17	21	25	30	32	P04	EXI2 EXTRG2 COM0	SU0_SCLK	-	I2CU0_SCL	TMH0OUT	-	-	-
17	18	22	26	31	33	P05	COM1	-	-	-	-	-	-	-
18	19	23	27	32	34	P06	COM2	-	-	I2CM0_SDA	-	-	-	-
19	20	24	28	33	35	P07	COM3 SEG0	SU0_RXD1	SU0_RXD0	I2CM0_SCL	-	-	-	-
20	21	25	29	34	36	P10	COM4 SEG1	SU0_TXD1	-	-	-	-	-	-
21	22	26	30	35	37	P11	COM5 SEG2	SU0_SCLK	-	-	-	-	-	-
22	23	27	31	36	38	P12	COM6 SEG3	SU0_RXD0 SU0_SIN	-	-	TMH4OUT	-	-	-
23	24	28	32	37	39	P13	COM7 SEG4	SU0_TXD0 SU0_SOUT	SU0_TXD1	-	TMH1OUT	-	TMH3OUT	-
25	27	35	45	57	59	P14	SEG22	-	-	-	-	-	-	-
26	28	36	46	58	60	P15	SEG23	-	-	I2CU0_SDA	-	-	-	-
27	29	37	47	59	61	P16	SEG24	SU1_SCLK	-	I2CU0_SCL	TMH5OUT	-	-	-
28	30	38	48	60	62	P17	EXI3 EXTRG3 SEG25	SU0_RXD1	SU0_RXD0	-	FTM1P	TBCOUT0	BZ0P	AIN0
29	31	39	49	61	63	P20	SEG26	SU0_TXD1	-	-	FTM1N	TBCOUT1	BZ0N	AIN1
30	32	40	50	62	64	P21	EXI4 EXTRG4 SEG27	SU1_RXD0 SU1_SIN	-	-	FTM2P	OUTLSCLK	-	AIN2
31	33	41	51	63	65	P22	SEG28	SU1_TXD0 SU1_SOUT	SU1_TXD1	I2CM0_SDA	FTM2N	OUTHCLK	-	AIN3
32	34	42	52	64	66	P23	EXI5 EXTRG5 V _{REF} SEG29	SU1_SCLK	-	I2CM0_SCL	TMH2OUT	-	-	V _{REF0}
33	35	43	53	65	67	P24	SEG30	SU1_RXD0 SU1_SIN	-	-	-	-	-	AIN4
34	36	44	54	66	68	P25	SEG31	SU1_TXD0 SU1_SOUT	SU1_TXD1	-	-	-	-	AIN5
35	37	45	55	67	69	P26	EXI6 EXTRG6 SEG32	SU1_RXD1	SU1_RXD0	I2CU0_SDA	FTM3P	TBCOUT0	BZ0P	AIN6
36	38	46	56	68	70	P27	EXI7 EXTRG7 SEG33	SU1_TXD1	-	I2CU0_SCL	FTM3N	TBCOUT1	BZ0N	AIN7

*1: No assignment to ML62Q1500 Series.

Table 3 Pin List (2/3)

Pin No.						Pin name (1 st func.)	1 st func. others	2 nd func. SIU *3	3 rd func. SIU *3	4 th func. I2C	5 th func. Timer *3	6 th func. others	7 th func. others	8 th func. ADC *3
48 Pin	52 Pin	64 Pin	80 pin	TOFP100	QFP100									
37	41	51	67	84	86	P30	SEG49	-	-	-	-	-	-	-
38	42	52	68	85	87	P31	SEG50	-	-	-	-	TBCOUT0	TBCOUT1	-
39	43	53	69	86	88	P32	SEG51	SU1_RXD1	SU1_RXD0	-	-	-	-	-
40	44	54	70	87	89	P33	SEG52	SU1_TXD1	-	-	TMH3OUT	-	-	-
-	-	49	65	82	84	P40	SEG47	SU5_TXD1	-	-	-	-	-	-
-	40	50	66	83	85	P41	SEG48	-	-	-	-	-	-	-
-	-	63	79	96	98	P42	SEG61	SU3_TXD1	-	-	-	-	-	-
48	52	64	80	100	2	P43	-	-	-	-	-	TBCOUT0	TBCOUT1	AIN10
-	-	9	12	17	19	P44	DACOUT1	SU4_RXD1	SU4_RXD0	-	FTM3N *1	-	-	-
-	-	10	13	18	20	P45	-	SU4_TXD1	-	-	-	-	-	-
-	-	13	16	21	23	P46	-	-	-	I2CU0_SDA *1	FTM1N *1	-	-	-
-	11	14	17	22	24	P47	-	SU0_SCLK *1	-	I2CU0_SCL *2	FTM1P *1	-	-	-
24	25	29	33	38	40	P50	EXI8 SEG5	-	-	-	-	-	-	-
-	26	30	34	39	41	P51	SEG6	-	-	-	-	-	-	-
-	-	31	35	40	42	P52	SEG7	SU4_RXD1	SU4_RXD0	-	-	-	-	-
-	-	32	36	41	43	P53	SEG8	SU4_TXD1	-	-	-	-	-	-
-	-	33	43	55	57	P54	SEG20	SU2_RXD1	SU2_RXD0	-	TMH7OUT	-	-	-
-	-	34	44	56	58	P55	SEG21	SU2_TXD1	-	-	-	-	-	-
-	39	47	57	69	71	P56	SEG34	SU2_RXD0 SU2_SIN	-	-	-	-	-	AIN12
-	-	48	58	70	72	P57	SEG35	SU2_TXD0 SU2_SOUT	SU2_TXD1	-	-	-	-	AIN13
41	45	55	71	88	90	P60	SEG53	-	-	I2CM1_SCL	-	-	-	-
42	46	56	72	89	91	P61	SEG54	-	-	I2CM1_SDA	-	-	-	-
43	47	57	73	90	92	P62	SEG55	-	-	-	FTM4N	-	CMP1P	-
44	48	58	74	91	93	P63	SEG56	-	-	-	FTM4P	-	CMP1M	-
45	49	59	75	92	94	P64	EXI9 SEG57	SU3_RXD0 SU3_SIN	-	-	FTM5P	-	-	-
46	50	60	76	93	95	P65	SEG58	SU3_TXD0 SU3_SOUT	SU3_TXD1	-	FTM5N	-	-	AIN8
47	51	61	77	94	96	P66	SEG59	SU3_SCLK	-	-	-	-	-	AIN9
-	-	62	78	95	97	P67	SEG60	SU3_RXD1	SU3_RXD0	-	-	-	-	-
-	-	20	24	29	31	P70	-	-	-	-	TMH6OUT	-	-	-
15	16	19	23	28	30	V _{L3}	-	-	-	-	-	-	-	-
14	15	18	22	27	29	V _{L2}	-	-	-	-	-	-	-	-
13	14	17	21	26	28	V _{L1}	-	-	-	-	-	-	-	-
12	13	16	20	25	27	C ₂	-	-	-	-	-	-	-	-
11	12	15	19	24	26	C ₁	-	-	-	-	-	-	-	-
-	-	-	18	23	25	P76	EXI10	-	-	-	-	-	-	-
-	-	-	-	99	1	P77	SEG64	-	-	-	-	-	-	-

*1: No assignment to ML62Q1500 Series.

*2: No assignment to ML62Q1500 Series and products of 52 PIN-package.

*3: The pins of name with DACOUT1, SU2, SU3, SU4, SU5, TMH6, TMH7, AIN12 or AIN13 are not assigned to products of 48/52/64 PIN-packages.

Table 3 Pin List (3/3)

Pin No.					Pin name (1 st func)	1 st func. others	2 nd func. SIU	3 rd func. SIU	4 th func. I2C	5 th func. Timer	6 th func. others	7 th func. others	8 th func. ADC
48 Pin	52 Pin	64 Pin	80 pin	TOFP100									
-	-	-	9	9	11	P80	-	SU4_RXD0 SU4_SIN	-	-	-	-	-
-	-	-	10	10	12	P81	-	SU4_TXD0 SU4_SOUT	SU4_TXD1	-	-	-	-
-	-	-	11	11	13	P82	-	SU4_SCLK	-	-	-	-	-
-	-	-	-	12	14	P83	-	SU5_RXD0	-	-	-	-	-
-	-	-	-	13	15	P84	-	SU5_TXD0	SU5_TXD1 *1	-	-	-	-
-	-	-	-	14	16	P85	-	-	-	-	-	-	-
-	-	-	-	15	17	P86	-	-	-	FTM7P *1	-	-	-
-	-	-	-	16	18	P87	-	-	-	FTM7N *1	-	-	-
-	-	-	-	42	44	P90	SEG9	-	-	-	-	-	-
-	-	-	-	43	45	P91	SEG10	-	-	-	-	-	-
-	-	-	-	44	46	P92	SEG11	-	-	-	-	-	-
-	-	-	37	45	47	P93	SEG12	SU4_RXD0 SU4_SIN	-	-	FTM6P	-	-
-	-	-	38	46	48	P94	SEG13	SU4_TXD0 SU4_SOUT	SU4_TXD1	-	FTM6N	-	-
-	-	-	39	47	49	P95	SEG14	SU4_SCLK	-	-	-	-	-
-	-	-	40	48	50	P96	SEG15	-	-	-	-	-	-
-	-	-	-	49	51	P97	SEG16	-	-	-	-	-	-
-	-	-	-	50	52	PA0	SEG17	-	-	-	-	-	-
-	-	-	-	53	55	PA1	SEG18	-	-	-	-	-	-
-	-	-	-	54	56	PA2	SEG19	-	-	-	-	-	-
-	-	-	59	71	73	PA3	EXI11 SEG36	SU2_SCLK	-	-	FTM7P	-	AIN14
-	-	-	60	72	74	PA4	SEG37	-	-	-	FTM7N	-	AIN15
-	-	-	-	73	75	PA5	SEG38	-	-	-	-	-	-
-	-	-	-	74	76	PA6	SEG39	-	-	-	-	-	-
-	-	-	-	75	77	PA7	SEG40	-	-	-	-	-	-
-	-	-	-	76	78	PB0	SEG41	-	-	-	-	-	-
-	-	-	-	77	79	PB1	SEG42	-	-	-	-	-	-
-	-	-	61	78	80	PB2	SEG43	SU5_RXD0 SU5_SIN	-	-	-	-	-
-	-	-	62	79	81	PB3	SEG44	SU5_TXD0 SU5_SOUT	SU5_TXD1	-	-	-	-
-	-	-	63	80	82	PB4	SEG45	SU5_SCLK	-	-	-	-	-
-	-	-	64	81	83	PB5	SEG46	SU5_RXD1	SU5_RXD0	-	-	-	-
-	-	-	-	97	99	PB6	SEG62	-	-	-	-	-	-
-	-	-	-	98	100	PB7	SEG63	-	-	-	-	-	-

*1: No assignment to ML62Q1500 Series.

PIN DESCRIPTION

Table 4 Pin Description (1/7)

Function	Signal name	Pin name	I/O	Description	Logic
Power	—	V _{SS}	—	Negative power supply pin (-)	—
	—	V _{DD}	—	Positive power supply pin (+). Connect a capacitor C _V between this pin and V _{SS} to stabilize power supply.	—
	—	V _{DDL}	—	Power supply pin for internal logic (internal regulator's output). Connect a capacitor C _L (1μF) between this pin and V _{SS} .	—
Test	TEST0	P00	I/O	Input pin for testing. Also, used for on-chip debug interface or ISP function. P00 is initialized as pull-up input mode by the system reset (not high-impedance mode).	—
Un used	NC	NC	—	Recommended to connect to V _{SS} .	—
System	V _{REF}	P23	—	Reference voltage output. An internal reference voltage in the SA type A/D converter block can be externally used for a reference. The pin is shared with the SA type A/D converter external reference voltage input.	—
	RESET_N	RESET_N	I	Input for reset. Asserting "L" level to this pin enters the MCU into system reset mode and internal circuits are initialized, then releasing it to "H" level make CPU start running the program. Used for on-chip debug interface or ISP function. Internal pull-up resistor is not installed.	Negative
	XT0	XT0	I	Low speed crystal oscillation pins Connect 32.768kHz crystal resonator and have capacitors between the pin and V _{SS} .	—
	XT1	XT1	O		—
	OUTLSCLK	P02 P21	O	Low-speed clock output.	—
	OUTHCLK	P03 P22	O	High-speed clock output.	—
General input port (GPI)	PI00, PI01	XT0, XT1	I	General Input port. Not available to use as general inputs when using the crystal resonator.	Positive
General port (GPIO)	P00	P00	I/O	General I/O port - High-impedance - Input with Pull-UP (initial value) - Input without Pull-UP - CMOS output - N-channel open drain output P00 is only initialized as pulled-up input and other ports are initialized as high-impedance Not available to use as I/O pin when using for on-chip debug interface or ISP function.	Positive
	P01 – P07	P01 – P07	I/O	General I/O port - High-impedance (initial value) - Input with Pull-UP - Input without Pull-UP - CMOS output - N-channel open drain output	Positive
	P10 – P17	P10 – P17			
	P20 – P27	P20 – P27			
	P30 – P33	P30 – P33			
	P40 – P47	P40 – P47			
	P50 – P57	P50 – P57			
	P60 – P67	P60 – P67			
	P70, P76, P77	P70, P76, P77			
	P80 – P87	P80 – P87			
	P90 – P97	P90 – P97			
	PA0 – PA7	PA0 – PA7			
PB0 – PB7	PB0 – PB7				

Table 4 Pin Description (2/7)

Function	Signal name	Pin name	I/O	Description	Logic
UART	SU0_TXD0	P03	O	Serial communication unit0/UART0 data output pin.	Positive
		P13			
	SU0_RXD0	P02	I	Serial communication unit0/UART0 data input pin.	Positive
		P07			
		P12			
		P17			
	SU0_TXD1	P03	O	Serial communication unit0/UART1 data output pin.	Positive
		P10			
		P13			
		P20			
	SU0_RXD1	P07	I	Serial communication unit0/UART1 data input pin.	Positive
		P17			
	SU1_TXD0	P22	O	Serial communication unit1/UART0 data output pin.	Positive
		P25			
	SU1_RXD0	P21	I	Serial communication unit1/UART0 data input pin.	Positive
		P24			
		P26			
		P32			
	SU1_TXD1	P22	O	Serial communication unit1/UART1 data output pin.	Positive
		P25			
		P27			
		P33			
	SU1_RXD1	P26	I	Serial communication unit1/UART1 data input pin.	Positive
		P32			
	SU2_TXD0	P57	O	Serial communication unit2/UART0 data output pin.	Positive
	SU2_RXD0	P54	I	Serial communication unit2/UART0 data input pin.	Positive
		P56			
	SU2_TXD1	P55	O	Serial communication unit2/UART1 data output pin.	Positive
		P57			
	SU2_RXD1	P54	I	Serial communication unit2/UART1 data input pin.	Positive
SU3_TXD0	P65	O	Serial communication unit3/UART0 data output pin.	Positive	
SU3_RXD0	P64	I	Serial communication unit3/UART0 data input pin.	Positive	
	P67				
SU3_TXD1	P42	O	Serial communication unit3/UART1 data output pin.	Positive	
	P65				
SU3_RXD1	P67	I	Serial communication unit3/UART1 data input pin.	Positive	
SU4_TXD0	P81	O	Serial communication unit4/UART0 data output pin.	Positive	
	P94				
SU4_RXD0	P44	I	Serial communication unit4/UART0 data input pin.	Positive	
	P52				
	P80				
	P93				
SU4_TXD1	P45	O	Serial communication unit4/UART1 data output pin.	Positive	
	P53				
	P81				
	P94				
SU4_RXD1	P44	I	Serial communication unit4/UART1 data input pin.	Positive	
	P52				
SU5_TXD0	P84	O	Serial communication unit5/UART0 data output pin.	Positive	
	PB3				
SU5_RXD0	P83	I	Serial communication unit5/UART0 data input pin.	Positive	
	PB2				
	PB5				
SU5_TXD1	P40	O	Serial communication unit5/UART1 data output pin.	Positive	
	P84				
	PB3				
SU5_RXD1	PB5	I	Serial communication unit5/UART1 data input pin.	Positive	

Table 4 Pin Description (3/7)

Synchronous Serial Port	SU0_SIN	P02	I	Serial communication unit0/Synchronous serial data input pin.	Positive
		P12			
	SU0_SCLK	P04	I/O	Serial communication unit0/Synchronous serial clock I/O pin.	Positive
		P11			
		P47			
	SU0_SOUT	P03	O	Serial communication unit0/Synchronous serial data output pin.	Positive
		P13			
	SU1_SIN	P21	I	Serial communication unit1/Synchronous serial data input pin.	Positive
		P24			
	SU1_SCLK	P16	I/O	Serial communication unit1/Synchronous serial clock I/O pin.	Positive
		P23			
	SU1_SOUT	P22	O	Serial communication unit1/Synchronous serial data output pin.	Positive
		P25			
	SU2_SIN	P56	I	Serial communication unit2/Synchronous serial data input pin.	Positive
	SU2_SCLK	PA3	I/O	Serial communication unit2/Synchronous serial clock I/O pin.	Positive
	SU2_SOUT	P57	O	Serial communication unit2/Synchronous serial data output pin.	Positive
	SU3_SIN	P64	I	Serial communication unit3/Synchronous serial data input pin.	Positive
	SU3_SCLK	P66	I/O	Serial communication unit3/Synchronous serial clock I/O pin.	Positive
SU3_SOUT	P65	O	Serial communication unit3/Synchronous serial data output pin.	Positive	
SU4_SIN	P80	I	Serial communication unit4/Synchronous serial data input pin.	Positive	
	P93				
SU4_SCLK	P82	I/O	Serial communication unit4/Synchronous serial clock I/O pin.	Positive	
	P95				
SU4_SOUT	P81	O	Serial communication unit4/Synchronous serial data output pin.	Positive	
	P94				
SU5_SIN	PB2	I	Serial communication unit5/Synchronous serial data input pin.	Positive	
SU5_SCLK	PB4	I/O	Serial communication unit5/Synchronous serial clock I/O pin.	Positive	
SU5_SOUT	PB3	O	Serial communication unit5/Synchronous serial data output pin.	Positive	
I ² C Bus	I2CU0_SDA	P03	I/O	I ² C Unit0 (Master and Salve) Data I/O pin / N-ch open drain. Connect a pull-up resistor externally.	Positive
		P15			
		P26			
		P46			
	I2CU0_SCL	P02	I/O	I ² C Unit0 (Master and Salve) Clock I/O pin / N-ch open drain. Connect a pull-up resistor externally.	Positive
		P04			
		P16			
P27					
I2CM0_SDA	P06	I/O	I ² C Master0 Data I/O pin / N-ch open drain. Connect a pull-up resistor externally.	Positive	
	P22				
I2CM0_SCL	P07	I/O	I ² C Master0 Clock I/O pin / N-ch open drain. Connect a pull-up resistor externally.	Positive	
	P23				
I2CM1_SDA	P61	I/O	I ² C Master1 Data I/O pin / N-ch open drain. Connect a pull-up resistor externally.	Positive	
I2CM1_SCL	P60	I/O	I ² C Master1 Clock I/O pin / N-ch open drain. Connect a pull-up resistor externally.	Positive	

Table 4 Pin Description (4/7)

Function	Signal name	Pin name	I/O	Description	Logic
Functional Timer (FTM)	FTM0P	P02	O	Functional Timer0 output.	Positive
	FTM0N	P03	O	Functional Timer0 output.	Negative
	FTM1P	P17	O	Functional Timer1 output.	Positive
		P47			
	FTM1N	P20	O	Functional Timer1 output.	Negative
		P46			
	FTM2P	P21	O	Functional Timer2 output.	Positive
	FTM2N	P22	O	Functional Timer2 output.	Negative
	FTM3P	P01	O	Functional Timer3 output.	Positive
		P26			
	FTM3N	P27	O	Functional Timer3 output.	Negative
		P44			
	FTM4P	P63	O	Functional Timer4 output.	Positive
	FTM4N	P62	O	Functional Timer4 output.	Negative
	FTM5P	P64	O	Functional Timer5 output.	Positive
	FTM5N	P65	O	Functional Timer5 output.	Negative
	FTM6P	P93	O	Functional Timer6 output.	Positive
	FTM6N	P94	O	Functional Timer6 output.	Negative
	FTM7P	P86	O	Functional Timer7 output.	Positive
		PA3			
FTM7N	P87	O	Functional Timer7 output.	Negative	
	PA4				
EXTRG0	P02	I	Functional Timer event trigger input pin.	—	
EXTRG1	P03	I	Functional Timer event trigger input pin.	—	
EXTRG2	P04	I	Functional Timer event trigger input pin.	—	
EXTRG3	P17	I	Functional Timer event trigger input pin.	—	
EXTRG4	P21	I	Functional Timer event trigger input pin.	—	
EXTRG5	P23	I	Functional Timer event trigger input pin.	—	
EXTRG6	P26	I	Functional Timer event trigger input pin.	—	
EXTRG7	P27	I	Functional Timer event trigger input pin.	—	
16-bit Timer	TMH0OUT	P04	O	16-bit Timer 0 output pin	Positive
	TMH1OUT	P13	O	16-bit Timer 1 output pin	Positive
	TMH2OUT	P23	O	16-bit Timer 2 output pin	Positive
		P33			
	TMH3OUT	P13	O	16-bit Timer 3 output pin	Positive
	TMH4OUT	P12	O	16-bit Timer 4 output pin	Positive
	TMH5OUT	P16	O	16-bit Timer 5 output pin	Positive
	TMH6OUT	P70	O	16-bit Timer 6 output pin	Positive
	TMH7OUT	P54	O	16-bit Timer 7 output pin	Positive
EXTRG0	P02	I	16-bit Timer event trigger input pin.	—	
EXTRG1	P03	I	16-bit Timer event trigger input pin.	—	
Low-speed Time Base Counter (LTBC)	TBCOUT0	P01	O	The virtual frequency adjustment signal or Low-speed Time Base Counter 1Hz/2Hz output pin	Positive
		P17			
		P26			
		P31			
	TBCOUT1	P01	O	Low-speed Time Base Counter 1Hz/2Hz output pin	Positive
		P20			
		P27			
		P31			
Buzzer	BZ0P	P17	O	Buzzer output (positive phase)	Positive
		P26			
	BZ0N	P20	O	Buzzer output (negative phase)	Negative
		P27			

Table 4 Pin Description (5/7)

Function	Signal name	Pin name	I/O	Description	Logic
External Interrupt	EXI0	P02	I	GPIO maskable external interrupt pin	—
	EXI1	P03	I	GPIO maskable external interrupt pin	—
	EXI2	P04	I	GPIO maskable external interrupt pin	—
	EXI3	P17	I	GPIO maskable external interrupt pin	—
	EXI4	P21	I	GPIO maskable external interrupt pin	—
	EXI5	P23	I	GPIO maskable external interrupt pin	—
	EXI6	P26	I	GPIO maskable external interrupt pin	—
	EXI7	P27	I	GPIO maskable external interrupt pin	—
	EXI8	P50	I	GPIO maskable external interrupt pin	—
	EXI9	P64	I	GPIO maskable external interrupt pin	—
	EXI10	P76	I	GPIO maskable external interrupt pin	—
Successive approximation type A/D converter	V _{REF}	P23	—	SA type A/D converter external reference voltage input. The voltage provided to the pin is used as the reference voltage for the A/D conversion.	—
	AIN0	P17	I	SA type A/D converter channel 0 input pin	—
	AIN1	P20	I	SA type A/D converter channel 1 input pin	—
	AIN2	P21	I	SA type A/D converter channel 2 input pin	—
	AIN3	P22	I	SA type A/D converter channel 3 input pin	—
	AIN4	P24	I	SA type A/D converter channel 4 input pin	—
	AIN5	P25	I	SA type A/D converter channel 5 input pin	—
	AIN6	P26	I	SA type A/D converter channel 6 input pin	—
	AIN7	P27	I	SA type A/D converter channel 7 input pin	—
	AIN8	P65	I	SA type A/D converter channel 8 input pin	—
	AIN9	P66	I	SA type A/D converter channel 9 input pin	—
	AIN10	P43	I	SA type A/D converter channel 10 input pin	—
	AIN11	P03	I	SA type A/D converter channel 11 input pin	—
	AIN12	P56	I	SA type A/D converter channel 12 input pin	—
	AIN13	P57	I	SA type A/D converter channel 13 input pin	—
	AIN14	PA3	I	SA type A/D converter channel 14 input pin	—
AIN15	PA4	I	SA type A/D converter channel 15 input pin	—	
Analog comparator	CMP0P	P03	I	Comparator input 0 (noninverting input)	—
	CMP0M	P02	I	Comparator input 0 (inverting input)	—
	CMP1P	P62	I	Comparator input 1 (noninverting input)	—
	CMP1M	P63	I	Comparator input 1 (inverting input)	—
D/A converter	DACOUT0	P01	O	D/A converter0 output pin	—
	DACOUT1	P44	O	D/A converter1 output pin	—

Table 4 Pin Description (6/7)

Function	Signal name	Pin name	I/O	Description	Logic
LCD driver	COM0	P04	—	Common output pin	—
	COM1	P05	—	Common output pin	—
	COM2	P06	—	Common output pin	—
	COM3/SEG0	P07	—	Common/Segment output shared pin	—
	COM4/SEG1	P10	—	Common/Segment output shared pin	—
	COM5/SEG2	P11	—	Common/Segment output shared pin	—
	COM6/SEG3	P12	—	Common/Segment output shared pin	—
	COM7/SEG4	P13	—	Common/Segment output shared pin	—
	SEG5	P50	—	Segment output pin	—
	SEG6	P51	—	Segment output pin	—
	SEG7	P52	—	Segment output pin	—
	SEG8	P53	—	Segment output pin	—
	SEG9	P90	—	Segment output pin	—
	SEG10	P91	—	Segment output pin	—
	SEG11	P92	—	Segment output pin	—
	SEG12	P93	—	Segment output pin	—
	SEG13	P94	—	Segment output pin	—
	SEG14	P95	—	Segment output pin	—
	SEG15	P96	—	Segment output pin	—
	SEG16	P97	—	Segment output pin	—
	SEG17	PA0	—	Segment output pin	—
	SEG18	PA1	—	Segment output pin	—
	SEG19	PA2	—	Segment output pin	—
	SEG20	P54	—	Segment output pin	—
	SEG21	P55	—	Segment output pin	—
	SEG22	P14	—	Segment output pin	—
	SEG23	P15	—	Segment output pin	—
	SEG24	P16	—	Segment output pin	—
	SEG25	P17	—	Segment output pin	—
	SEG26	P20	—	Segment output pin	—
	SEG27	P21	—	Segment output pin	—
	SEG28	P22	—	Segment output pin	—
	SEG29	P23	—	Segment output pin	—
	SEG30	P24	—	Segment output pin	—
	SEG31	P25	—	Segment output pin	—
	SEG32	P26	—	Segment output pin	—
	SEG33	P27	—	Segment output pin	—
	SEG34	P56	—	Segment output pin	—
	SEG35	P57	—	Segment output pin	—
	SEG36	PA3	—	Segment output pin	—
	SEG37	PA4	—	Segment output pin	—
	SEG38	PA5	—	Segment output pin	—
	SEG39	PA6	—	Segment output pin	—
	SEG40	PA7	—	Segment output pin	—
	SEG41	PB0	—	Segment output pin	—
	SEG42	PB1	—	Segment output pin	—
SEG43	PB2	—	Segment output pin	—	
SEG44	PB3	—	Segment output pin	—	
SEG45	PB4	—	Segment output pin	—	
SEG46	PB5	—	Segment output pin	—	

Table 4 Pin Description (7/7)

Function	Signal name	Pin name	I/O	Description	Logic
LCD driver	SEG47	P40	—	Segment output pin	—
	SEG48	P41	—	Segment output pin	—
	SEG49	P30	—	Segment output pin	—
	SEG50	P31	—	Segment output pin	—
	SEG51	P32	—	Segment output pin	—
	SEG52	P33	—	Segment output pin	—
	SEG53	P60	—	Segment output pin	—
	SEG54	P61	—	Segment output pin	—
	SEG55	P62	—	Segment output pin	—
	SEG56	P63	—	Segment output pin	—
	SEG57	P64	—	Segment output pin	—
	SEG58	P65	—	Segment output pin	—
	SEG59	P66	—	Segment output pin	—
	SEG60	P67	—	Segment output pin	—
	SEG61	P42	—	Segment output pin	—
	SEG62	PB6	—	Segment output pin	—
	SEG63	PB7	—	Segment output pin	—
	SEG64	P77	—	Segment output pin	—
		C ₁ ,C ₂	C ₁ ,C ₂	—	LCD bias power source generation capacitor connection pin
	V _{L1} ~V _{L3}	V _{L1} ~V _{L3}	—	LCD bias power source pin. Connect the capacitors (C _{L1} ,C _{L2} ,C _{L3}) between the pin and V _{SS} .	—

TERMINATION OF UNUSED PINS

Table 5 Termination of unused pins

Pin	Recommended pin termination
NC	Connect to V _{SS}
RESET_N	Connect to V _{DD} through a resistor
P00/TEST0	Open the pin with the internal initial condition of pulled-up input mode.
XT0/PI00, XT1/PI01	Open the pins with the internal initial condition of Hi-impedance mode.
P01 to P07	
P10 to P17	
P20 to P27	
P30 to P33	
P40 to P47	
P50 to P57	
P60 to P67	
P70, P76, P77	
P80 to P87	
P90 to P97	
PA0 to PA7	
PB0 to PB7	
C ₁ ,C ₂	Open
V _{L1} ,V _{L2}	Open
V _{L3}	Connect to V _{DD} through a resistor

Note:

For unused input ports or unused input/output ports, if an unstable middle level voltage is supplied to the corresponding pins which are configured as inputs without pull-up register or input/output mode, supply current may become excessively large. Therefore, it is recommended to configure those pins as either input mode with a pull-up resistor or output mode.

ELECTRICAL CHARACTERISTICS

Absolute Maximum Ratings

(V_{SS} = 0V)

Parameter	Symbol	Condition	Rating	Unit	
Power supply voltage 1	V _{DD}	Ta = +25°C	-0.3 to +6.5	V	
Power supply voltage 2	V _{DDL}	Ta = +25°C	-0.3 to +2.0	V	
Power supply voltage 3	V _{L3}	Ta = +25°C	-0.3 to +6.5	V	
Power supply voltage 4	V _{L1} , V _{L2}	Ta = +25°C	-0.3 to V _{L3} +0.3 ^{*1}	V	
Input voltage	V _{IN}	Ta = +25°C	-0.3 to V _{DD} +0.3 ^{*1}	V	
Output voltage1	V _{OUT1}	Ta = +25°C	-0.3 to V _{DD} +0.3 ^{*1}	V	
Output voltage2	V _{OUT2}	Ta = +25°C	-0.3 to +6.5	V	
“H” level output current	I _{OUTH}	Ta = +25°C	1pin	-40 ^{*2}	mA
			Total	-110 ^{*2}	
“L” level output current	I _{OUTL}	Ta = +25°C	1pin	+40	mA
			Total	+110	
Power dissipation	PD	Ta = +25°C	1	W	
Storage temperature	T _{STG}	—	-55 to +150	°C	

^{*1} 6.5V or lower^{*2} The current flowing out the LSI through the pin is described in the negative number.

The applicable maximum current is the absolute value.

For example, -1mA means the maximum current 1mA flows out the LSI through the pin.

[Note] Use the product within absolute maximum ratings. The absolute maximum ratings are conditions which may physically deteriorate the quality of product.

Recommended Operating Conditions

(V_{SS} = 0V)

Parameter	Symbol	Condition	Range	Unit
Operating temperature	T _{OP}	—	-40 to +105	°C
Operating voltage 1	V _{DD}	—	1.6 to 5.5	V
Operating voltage 2	V _{L3}	External supply method	2.7 to 5.5	V
Operating voltage 3	V _{L2}	External supply method	2/3 x V _{L3}	V
Operating voltage 4	V _{L1}	External supply method	1/3 x V _{L3}	V
Operating frequency (CPU)	f _{OP}	V _{DD} = 1.6 to 5.5V	30k to 4M	Hz
		V _{DD} = 1.8 to 5.5V	30k to 25M	
V _{DDL} pin external capacitance	C _L	—	1.0 ±30%	μF
V _{L1} , V _{L2} , V _{L3} pin external capacitance	C _{L1} , C _{L2} , C _{L3}	—	0.47±30% or 1.0±30%	μF
C ₁ and C ₂ pin external capacitance	C ₁₂	—	0.47±30% or 1.0±30%	μF

Operation Confirmed Crystal Unit (32.768kHz)

(V_{DD}=1.6 to 5.5V, V_{SS}=0V)

manufacturer	Part number	Temperature [°C]	Load capacitance CL [pF]	Oscillation mode			Oscillation circuit parameter ^{*2*} (Reference data)	
				Low power	Standard	Tough	C _{DL} [pF]	C _{GL} [pF]
Kyocera	ST3215SB	-40 to +105	7	●	-	-	12	12
				-	●	●	13	13
				-	-	●	20	20
River-eletec	TFX-04	-40 to +105	5	●	-	-	8	8
				-	●	-	9	8
				-	-	●	10	10
Nihon Dempa Kogyo	NX3215SA	-40 to +85	9	●	●	●	15	15
SII	VT-200F	-40 to +85	6	●	-	-	9	9
			12.5	-	●	●	22	22
Daishinku	DST1610A	-40 to +85	6	-	●	●	10	10
	DT-26	-10 to +60	6	●	●	●	10	10
				-	●	●	22	22

* These are crystal units that operation with our reference board has been confirmed.

*² These include wiring and parasitic capacitance.*³ These are reference data. Please optimize them on user system.

Current Consumption 1

Product: ML62Q1700, ML62Q1701, ML62Q1702, ML62Q1703, ML62Q1704, ML62Q1710,
ML62Q1711, ML62Q1712, ML62Q1713, ML62Q1714, ML62Q1720, ML62Q1721,
ML62Q1722, ML62Q1723, ML62Q1724

(V_{DD}=1.6 to 5.5V, V_{SS}=0V, Ta=-40 to +105°C, unless otherwise specified)

Parameter	Symbol	Condition	Min.	Typ.* ³	Max.	Unit	Measuring circuit
Supply current 0	IDD0	CPU is in STOP-D state. Low-speed RC1K/RC32K and PLL oscillation are stopped.	Ta = -40 to +85 °C	—	0.8	37	μA
			Ta = -40 to +105 °C	—		75	
Supply current 1	IDD1	CPU is in STOP state. Low-speed RC1K/RC32K and PLL oscillation are stopped.	Ta = -40 to +85 °C	—	1.0	40	μA
			Ta = -40 to +105 °C	—		80	
Supply current 2-1	IDD2-1	Low-speed RC32K Oscillating. CPU is in HALT state (LTBC and WDT are operating ^{*1}). PLL oscillation is stopped.	Ta = -40 to +85 °C	—	4.9	42	μA
			Ta = -40 to +105 °C	—		85	
Supply current 2-2	IDD2-2	Low-speed Crystal Oscillating. ^{*4} CPU is in HALT state (LTBC and WDT are operating ^{*1}). PLL oscillation is stopped.	Ta = -40 to +85 °C	—	3.3	42	μA
			Ta = -40 to +105 °C	—		85	
Supply current 3	IDD3	CPU: Running with low-speed RC32K oscillation clock ^{*1*2} PLL oscillation is stopped.	Ta = -40 to +105 °C	—	17	105	μA
Supply current 4	IDD4	CPU: Running with 16MHz PLL oscillating clock ^{*2} PLL 16MHz is oscillating. V _{DD} =1.8~5.5V	Ta = -40 to +105 °C	—	3.4	4.5	mA
Supply current 5	IDD5	CPU: Running with 24MHz PLL oscillating clock ^{*2} PLL 24MHz is oscillating. V _{DD} =1.8~5.5V	Ta = -40 to +105 °C	—	4.8	6.0	

1

*¹ LTBC and WDT is operating, Significant bits of BLKCON0-3 and BRECON0-3 registers are all "1"

*² CPU running in wait mode

*³ On the condition of V_{DD}=3.0V, Ta=+25°C

*⁴ When the noise filter is not used in the low power consumption mode

Current Consumption 2

Product: ML62Q1725, ML62Q1726, ML62Q1727, ML62Q1733, ML62Q1734, ML62Q1735, ML62Q1736,
ML62Q1737, ML62Q1743, ML62Q1744, ML62Q1745, ML62Q1746, ML62Q1747

(V_{DD}=1.6 to 5.5V, V_{SS}=0V, Ta=-40 to +105°C, unless otherwise specified)

Parameter	Symbol	Condition	Min.	Typ.* ³	Max.	Unit	Measuring circuit
Supply current 0	IDD0	CPU is in STOP-D state. Low-speed RC1K/RC32K and PLL oscillation are stopped.	Ta = -40 to +85 °C	—	1.0	55	μA
			Ta = -40 to +105 °C	—		110	
Supply current 1	IDD1	CPU is in STOP state. Low-speed RC1K/RC32K and PLL oscillation are stopped.	Ta = -40 to +85 °C	—	1.5	60	μA
			Ta = -40 to +105 °C	—		120	
Supply current 2-1	IDD2-1	Low-speed RC32K Oscillating. CPU is in HALT state (LTBC and WDT are operating ^{*1}). PLL oscillation is stopped.	Ta = -40 to +85 °C	—	5.7	76	μA
			Ta = -40 to +105 °C	—		135	
Supply current 2-2	IDD2-2	Low-speed Crystal Oscillating. ^{*4} CPU is in HALT state (LTBC and WDT are operating ^{*1}). PLL oscillation is stopped.	Ta = -40 to +85 °C	—	4.5	76	μA
			Ta = -40 to +105 °C	—		135	
Supply current 3	IDD3	CPU: Running with low-speed RC32K oscillation clock ^{*1*2} PLL oscillation is stopped.	Ta = -40 to +105 °C	—	20	150	μA
Supply current 4	IDD4	CPU: Running with 16MHz PLL oscillating clock ^{*2} PLL 16MHz is oscillating. V _{DD} =1.8~5.5V	Ta = -40 to +105 °C	—	4.0	5.0	mA
Supply current 5	IDD5	CPU: Running with 24MHz PLL oscillating clock ^{*2} PLL 24MHz is oscillating. V _{DD} =1.8~5.5V	Ta = -40 to +105 °C	—	5.7	7.0	

1

*¹ LTBC and WDT is operating, Significant bits of BLKCON0-3 and BRECON0-3 registers are all "1"

*² CPU running in wait mode

*³ On the condition of V_{DD}=3.0V, Ta=+25°C

*⁴ When the noise filter is not used in the low power consumption mode

Current Consumption 3

Product: ML62Q1728, ML62Q1729, ML62Q1738, ML62Q1739, ML62Q1748, ML62Q1749

(V_{DD}=1.6 to 5.5V, V_{SS}=0V, Ta=-40 to +105°C, unless otherwise specified)

Parameter	Symbol	Condition	Min.	Typ.* ³	Max.	Unit	Measuring circuit
Supply current 0	IDD0	CPU is in STOP-D state. Low-speed RC1K/RC32K and PLL oscillation are stopped.	Ta = -40 to +85 °C	—	1.2	57	μA
			Ta = -40 to +105 °C	—		140	
Supply current 1	IDD1	CPU is in STOP state. Low-speed RC1K/RC32K and PLL oscillation are stopped.	Ta = -40 to +85 °C	—	1.8	62	μA
			Ta = -40 to +105 °C	—		150	
Supply current 2-1	IDD2-1	Low-speed RC32K Oscillating. CPU is in HALT state (LTBC and WDT are operating ^{*1}). PLL oscillation is stopped.	Ta = -40 to +85 °C	—	6.0	78	μA
			Ta = -40 to +105 °C	—		165	
Supply current 2-2	IDD2-2	Low-speed Crystal Oscillating. ^{*4} CPU is in HALT state (LTBC and WDT are operating ^{*1}). PLL oscillation is stopped.	Ta = -40 to +85 °C	—	4.5	78	μA
			Ta = -40 to +105 °C	—		165	
Supply current 3	IDD3	CPU: Running with low-speed RC32K oscillation clock ^{*1*2} PLL oscillation is stopped.	Ta = -40 to +105 °C	—	20	190	μA
Supply current 4	IDD4	CPU: Running with 16MHz PLL oscillating clock ^{*2} PLL 16MHz is oscillating. V _{DD} =1.8~5.5V	Ta = -40 to +105 °C	—	4.0	5.0	mA
Supply current 5	IDD5	CPU: Running with 24MHz PLL oscillating clock ^{*2} PLL 24MHz is oscillating. V _{DD} =1.8~5.5V	Ta = -40 to +105 °C	—	5.7	7.0	

1

*¹ LTBC and WDT is operating, Significant bits of BLKCON0-3 and BRECON0-3 registers are all "1"*² CPU running in wait mode*³ On the condition of V_{DD}=3.0V, Ta=+25°C*⁴ When the noise filter is not used in the low power consumption mode

Low speed Crystal Oscillation

(V_{DD}=1.6 to 5.5V, V_{SS}=0V, Ta=-40 to +105°C, unless otherwise specified)

Parameter	Symbol	Condition	Range			Unit
			Min.	Typ.	Max.	
Crystal oscillation frequency *1 *2	f _{XTL}	—	—	32.768	—	kHz
Crystal oscillation start time	T _{XTL}	—	—	—	2	s

*1: The oscillation frequency is determined by the oscillation circuit, crystal resonator and the external capacitance (C_{GL}/C_{DL}). As those parameters changes depending the crystal resonator, it requires evaluation on the actual PCB circuit for matching. Ask crystal resonator makers for matching and confirm the oscillation characteristics.

*2: The quality of oscillation characteristics might be lost, depending on material of PCB, condition of wiring capacitance or parasitic capacitance on the external circuits. Note for designing the external circuit.

- Make the wires on the external circuit as short as possible.
- Place the crystal resonator and oscillation circuit as close to the MCU as possible and make the wires between the external capacitance and crystal resonator as short as possible.
- Ensure no signal line flowing big current runs near the oscillation circuit.
- Ensure no signal line runs under and near the oscillation circuit.
- Make ground of external capacitance the same as MCU ground V_{SS} pin and connect them to the ground that has low variation of current and voltage.
- The quality of oscillation characteristics might be lost depending on operating environment due to moisture absorption of PCB and condensation of PCB surface, recommended to have measures such as covering the oscillation circuit with resin.

Low speed Crystal Oscillation external circuit example

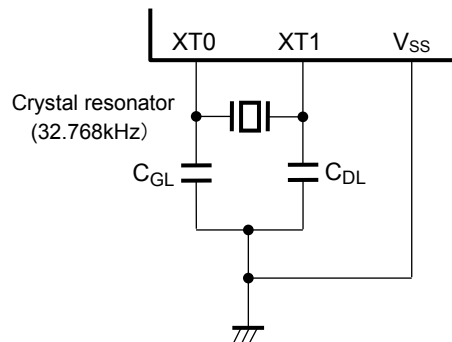

External Clock Input

(V_{DD}=1.6 to 5.5V, V_{SS}=0V, Ta=-40 to +105°C, unless otherwise specified)

Parameter	Symbol	Condition	Range			Unit
			Min.	Typ.	Max.	
Input Frequency	f _{EXCK}	—	Typ. -1.0%	32.768	Typ. +1.0%	kHz
Input pulse width	t _{EXCKW}	—	1/f _{EXCK} x 0.4		1/f _{EXCK} x 0.6	s

On-chip Oscillator

(V_{DD}=1.6 to 5.5V, V_{SS}=0V, Ta=-40 to +105°C, unless otherwise specified)

Parameter	Symbol	Condition	Min.	Typ.	Max.	Unit	Measuring circuit
Low-speed RC oscillator frequency accuracy 1	f _{RCL1}	Ta= +25°C V _{DD} = 1.8 to 5.5V Without software adjustment *1	Typ. -1.0%	32.768	Typ. +1.0%	kHz	1
		Ta= -40 to +85°C V _{DD} = 1.8 to 5.5V Without software adjustment *1	Typ. -2.5%	32.768	Typ. +2.5%		
		Ta= -40 to +105°C V _{DD} = 1.8 to 5.5V Without software adjustment *1	Typ. -3.0%	32.768	Typ. +3.0%		
		V _{DD} = 1.6 to 1.8V Without software adjustment *1	Typ. -3.5%	32.768	Typ. -3.5%		
Low-speed RC oscillator frequency accuracy 2	f _{RCL2}	Ta= -40 to +85°C V _{DD} = 1.8 to 5.5V With software adjustment *1	Typ. -1.0%	32.768	Typ. +1.0%		
		Ta= -40 to +105°C V _{DD} = 1.8 to 5.5V With software adjustment *1	Typ. -1.5%	32.768	Typ. +1.5%		
PLL oscillation frequency accuracy 1	f _{PLL1}	Ta= -40 to +85°C V _{DD} = 1.8 to 5.5V Without software adjustment *1	Typ. -2.5%	16/24	Typ. +2.5%	MHz	
		Ta= -40 to +105°C V _{DD} = 1.8 to 5.5V Without software adjustment *1	Typ. -3.0%	16/24	Typ. +3.0%		
		V _{DD} = 1.6 to 1.8V Without software adjustment *1	Typ. -3.5%	16/24	Typ. +3.5%		
PLL oscillation frequency accuracy 2	f _{PLL2}	Ta= -40 to +85°C V _{DD} = 1.8 to 5.5V With software adjustment *1	Typ. -1.0%	16/24	Typ. +1.0%		
		Ta= -40 to +105°C V _{DD} = 1.8 to 5.5V With software adjustment *1	Typ. -1.5%	16/24	Typ. +1.5%		
PLL oscillation start time	T _{PLL}	V _{DD} = 1.6 to 5.5V	—	—	2	ms	
1kHz Low-speed RC oscillator (for WDT) frequency accuracy	f _{RC1K}	Ta= -40 to +105°C V _{DD} = 1.6 to 5.5V	0.5	1	2.5	kHz	

*1 Adjust the frequency by using temperature sensor in ADC and a Specific Function Register (LRCADJ register)

Input / Output pin 1

(V_{DD}=1.6 to 5.5V, V_{SS}=0V, Ta=-40 to +105°C, unless otherwise specified)

Parameter	Symbol	Condition	Min.	Typ.	Max.	Unit	Measuring circuit	
Output voltage1 “H”/“L” level (P00-P07) (P10-P17) (P20-P27) (P30-P33) (P40-P47) (P50-P57) (P60-P67) (P70,P76,P77) (P80-P87) (P90-P97) (PA0-PA7) (PB0-PB7)	VOH1	IOH1=-10mA V _{DD} ≥4.5V	V _{DD} -1.5	—	—	V	2	
		IOH1=-1mA V _{DD} ≥1.6V	V _{DD} -0.5	—	—			
	VOL1	IOL1=+10mA V _{DD} ≥4.5V	—	—	1.5			
		IOL1=+1mA V _{DD} ≥1.6V	—	—	0.5			
Output voltage2 “L” level (P01-P07) (P10-P17) (P20-P27) (P30-P33) (P40-P47) (P50-P57) (P60-P67) (P70 P76,P77) (P80-P87) (P90-P97) (PA0-PA7) (PB0-PB7)	VOL2	When Nch open drain output mode is selected	IOL2=+15mA V _{DD} ≥4.5V	—	—	0.5		
			IOL2=+8mA V _{DD} ≥3.0V	—	—	0.5		
			IOL2=+3mA V _{DD} ≥2.0V	—	—	0.4		
			IOL2=+2mA V _{DD} ≥1.6V	—	—	0.4		
Output voltage 3 LCD COM/SEG (COM0~COM7) (SEG0~SEG64)	VOH3M	V _{L3} = 3V, V _{L2} = 2V, V _{L1} = 1V	IOH3M=-0.03mA V _{L3} output	V _{L3} -0.2	—	V	2	
	VOH3P		IOMH3P=+0.03mA V _{L2} output	—	—			V _{L2} +0.2
	VOMH3M		IOMH3M=-0.03mA V _{L2} output	V _{L2} -0.2	—			—
	VOML3P		IOML3P=+0.03mA V _{L1} output	—	—			V _{L1} +0.2
	VOML3M		IOML3M=-0.03mA V _{L1} output	V _{L1} -0.2	—			—
	VOL3P		IOL3P=+0.03mA V _{SS} output	—	—			0.2

Input / Output pin 2

(V_{DD}=1.6 to 5.5V, V_{SS}=0V, Ta=-40 to +105°C, unless otherwise specified)

Parameter	Symbol	Condition	Min.	Typ.	Max.	Unit	Measu ring circuit
“H” level output current1 *6	I _{OH1}	1pin	V _{DD} ≥4.5V	-10 ^{*3*5}	—	—	mA
			V _{DD} ≥1.6V	-1 ^{*3*5}	—	—	
“H” level output current1 *1*4 ^Å	IOH3	Total of ‘P00-P07, P10-P13, P44-P47, P50-P53, P70,P76, P80-P87, P90-P97, PA0’ or Total of ‘P14-P17, P20-P27, P30-P33, P40-P43, P54-P57 P60-P67,P77, PA1-PA7, PB0-PB7’ (duty≤50%)	V _{DD} ≥4.5V	-90 ^{*5}	—	—	
		V _{DD} ≥1.6V	-20 ^{*5}	—	—		
		All pin total (duty≤50%)	V _{DD} ≥4.5V	-180 ^{*5}	—	—	
“L” level output current1 *6	IOL1	1pin (CMOS output mode)	V _{DD} ≥4.5V	—	—	10 ^{*3}	
			V _{DD} ≥1.6V	—	—	1 ^{*3}	
“L” level output current2 *6	IOL2	1pin (Nch open drain output mode)	V _{DD} ≥4.5V	—	—	15 ^{*3}	
			V _{DD} ≥3.0V	—	—	8 ^{*3}	
			V _{DD} ≥2.0V	—	—	3 ^{*3}	
			V _{DD} ≥1.6V	—	—	2 ^{*3}	
“L” level output total current *2*4	IOL3	Total of P00-P07, P10-P13, P44-P47, P50-P53, P70,P76, P80-P87, P90-P97, PA0’ or Total of ‘P14-P17, P20-P27, P30-P33, P40-P43, P54-P57 P60-P67,P77, PA1-PA7, PB0-PB7’ (Nch open drain output mode,duty≤50%)	V _{DD} ≥4.5V	—	—	90	
			V _{DD} ≥3.0V	—	—	40	
		V _{DD} ≥2.0V	—	—	15		
		V _{DD} ≥1.6V	—	—	10		
		All pin total (Nch open drain output mode,duty≤50%)	V _{DD} ≥4.5V	—	—	180	
		V _{DD} ≥1.6V	—	—	20		
Output leak (P00-P07) (P10-P17) (P20-P27) (P30-P33) (P40-P47) (P50-P57) (P60-P67) (P70,P76,P77) (P80-P87) (P90-P97) (PA0-PA7) (PB0-PB7)	IOOH	VOH=V _{DD} (High impedance mode)	—	—	+1	µA	
	IOOL	VOL=V _{SS} (High impedance mode)	-1 ^{*5}	—	—		

3

*1 Sink-out current from V_{DD} to the output pin, which can guarantee the device operation.

*2 Sink-in current from the output pin to V_{SS} , which can guarantee the device operation.

*3 Do not exceed total current.

*4 The total current is on the condition of Duty \leq 50%(same applies to IOH1).

When the duty $>$ 50% the total current is calculated by following formula.

Total current = $IOL3 \times 50/n$ (When the duty is n%)

<For an example> When $IOL3=100mA$ and $n=80\%$,

Total current = $IOL3 \times 50/80 = 62.5mA$

Current allowed per 1pin is independent of the duty and specified as IOL1 and IOL2.

Do not apply current larger than Absolute Maximum Ratings.

*5 The current flowing out the LSI through the pin is described in the negative number.

The applicable maximum current is the absolute value.

For example, -1mA means the maximum current 1mA flows out the LSI through the pin.

*6 These values are satisfied with VOH1, VOL1 and VOL2.

Input / Output pin 3

(V_{DD}=1.6 to 5.5V, V_{SS}=0V, Ta=-40 to +105°C, unless otherwise specified)

Parameter	Symbol	Condition	Min.	Typ.	Max.	Unit	Measuring circuit
Input current1 (RESET_N)	I _{IH1}	V _{IH1} =V _{DD}	—	—	1	μA	4
	I _{IL1}	V _{IL1} =V _{SS}	-1* ¹	—	—		
Input current2 (P00/TEST0)	I _{IL2}	V _{IL2} =V _{SS} (pull-up mode) * ²	-1500* ¹	-300* ¹	-20* ¹	kΩ	
	V/I _{IL2}	V _{IL2} =V _{SS} (pull-up mode) * ²	3.7	10	80	μA	
	I _{IH2Z}	V _{IH2} =V _{DD} (High impedance mode)	—	—	1		
Input current3 (P01-P07) (P10-P17) (P20-P27) (P30-P33) (P40-P47) (P50-P57) (P60-P67) (P70,P76,P77) (P80-P87) (P90-P97) (PA0-PA7) (PB0-PB7)	I _{IL2Z}	V _{IL2} =V _{SS} (High impedance mode)	-1* ¹	—	—	μA	
	I _{IL3}	V _{IL1} =V _{SS} (pull-up mode) * ²	-250* ¹	-30* ¹	-2* ¹		
	V/I _{IL3}	V _{IL1} =V _{SS} (pull-up mode) * ²	22	100	800	μA	
	I _{IH3Z}	V _{IH1} =V _{DD} (High impedance mode)	—	—	1		
Input current4 (PI00-PI01)	I _{IL3Z}	V _{IL1} =V _{SS} (High impedance mode)	-1* ¹	—	—	μA	
	I _{IH4}	V _{IH1} =V _{DD}	—	—	1		
Input current4 (PI00-PI01)	I _{IL4}	V _{IL1} =V _{SS}	-1* ¹	—	—	μA	
	I _{IH4}	V _{IH1} =V _{DD}	—	—	1		
Input voltage1 (RESET_N) (P01-P07) (P10-P17) (P20-P27) (P30-P33) (P40-P47) (P50-P57) (P60-P67) (P70,P76,P77) (P80-P87) (P90-P97) (PA0-PA7) (PB0-PB7) (PI00-PI01)	V _{IH1}	—	0.7 x V _{DD}	—	V _{DD}	V	5
	V _{IL1}	—	0	—	0.3 x V _{DD}		
Input voltage2 (P00/TEST0)	V _{IH2}	—	0.7 x V _{DD}	—	V _{DD}	V	5
	V _{IL2}	—	0	—	0.25 x V _{DD}		
Pin capacitance (RESET_N) (P00/TEST0) (P01-P07) (P10-P17) (P20-P27) (P30-P33) (P40-P47) (P50-P57) (P60-P67) (P70,P76,P77) (P80-P87) (P90-P97) (PA0-PA7) (PB0-PB7) (PI00-PI01)	C _{PIN}	f = 10kHz Ta = +25°C	—	—	10	pF	—

*¹ The current flowing out the LSI through the pin is described in the negative number. The applicable maximum current is the absolute value. For example, -1mA means the maximum current 1mA flows out the LSI through the pin.

*² Measurement conditions: Typ. : V_{DD} = 3.0V, Max. : V_{DD} = 1.6V, Min. : V_{DD} = 5.5V

Synchronous Serial Port

Slave mode

($V_{DD}=1.8$ to $5.5V$, $V_{SS}=0V$, $T_a=-40$ to $+105^{\circ}C$, unless otherwise specified)

Parameter	Symbol	Condition	Min.	Typ.	Max.	Unit
SCK input cycle	t_{SCYC}	—	1 ^{*2}	—	—	μs
SCK input pulse width	t_{SW}	—	0.5 ^{*3}	—	—	μs
SOUT output delay time	t_{SD}	$V_{DD}=2.4$ to $5.5V$	—	—	100+ HSCLK ^{*1} $\times 3$	ns
		$V_{DD}=1.8$ to $5.5V$	—	—	200+ HSCLK ^{*1} $\times 3$	ns
SIN input setup time	t_{SS}	—	HSCLK ^{*1} $\times 1$	—	—	ns
SIN input hold time	t_{SH}	—	80+ HSCLK ^{*1} $\times 3$	—	—	ns

*1 Cycle of high speed clock

*2 Need input cycles of HSLCK x8 or longer

*3 Need input cycles of HSLCK x4 or longer

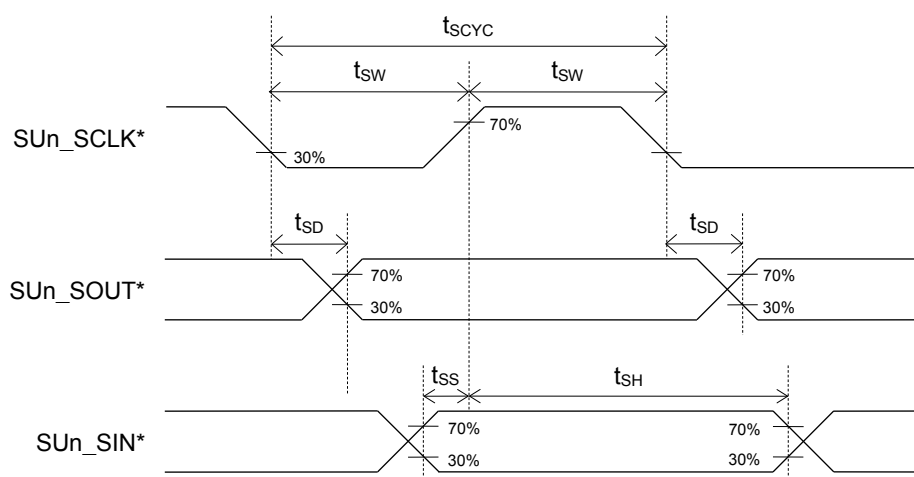

* 2nd to 8th function of port, n=0~5

Master mode

($V_{DD}=1.8$ to $5.5V$, $V_{SS}=0V$, $T_a=-40$ to $+105^{\circ}C$, unless otherwise specified)

Parameter	Symbol	Condition	Min.	Typ.	Max.	Unit
SCK output cycle	t_{SCYC}	—	—	$SCLK^{*1}$	—	ns
SCK output pulse width	t_{SW}	—	$SCLK^{*1} \times 0.4$	$SCLK^{*1} \times 0.5$	$SCLK^{*1} \times 0.6$	ns
SOUT output delay time	t_{SD}	$V_{DD}=2.4$ to $5.5V$	—	—	100	ns
		$V_{DD}=1.8$ to $5.5V$	—	—	160	ns
SIN input setup time	t_{SS}	$V_{DD}=2.4$ to $5.5V$	120	—	—	ns
		$V_{DD}=1.8$ to $5.5V$	180	—	—	ns
SIN input hold time	t_{SH}	$V_{DD}=2.4$ to $5.5V$	80	—	—	ns
		$V_{DD}=1.8$ to $5.5V$	100	—	—	ns

*1 Clock cycle selected by bit12~8(SnCK4~0) of the serial port n mode register (SIOOnMOD)
 $V_{DD} \geq 2.4V$: min250ns, $V_{DD} \geq 1.8V$: min500ns

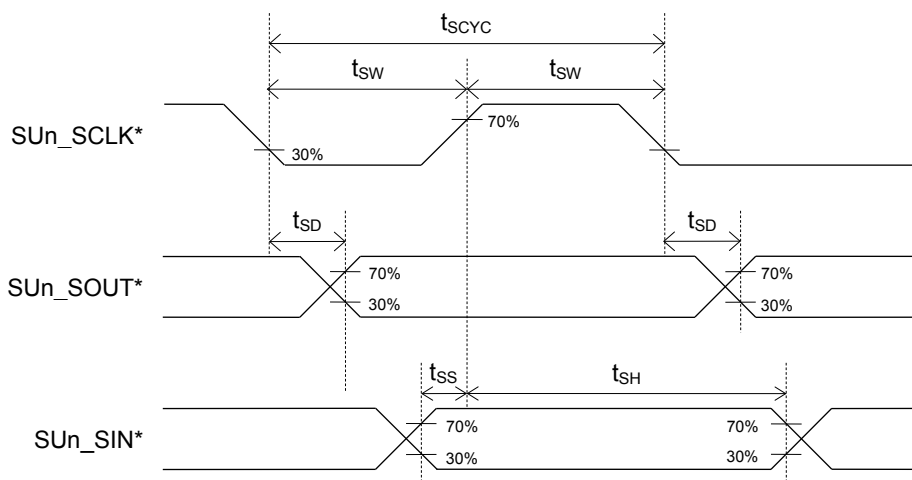

* 2nd to 8th function of port, n=0~5

I²C Bus Interface

Standard Mode 100kHz

(V_{DD}=1.8 to 5.5V, V_{SS}=0V, Ta=-40 to +105°C, unless otherwise specified)

Parameter	Symbol	Condition	Min.	Typ.	Max.	Unit
SCL clock frequency	f _{SCL}	—	0	—	100	kHz
SCL hold time (start/restart condition)	t _{HD:STA}	—	4.0	—	—	μs
SCL "L" level time	t _{LOW}	—	4.7	—	—	μs
SCL "H" level time	t _{HIGH}	—	4.0	—	—	μs
SCL setup time (restart condition)	t _{SU:STA}	—	4.7	—	—	μs
SDA hold time	t _{HD:DAT}	—	0	—	—	μs
SDA setup time	t _{SU:DAT}	—	0.25	—	—	μs
SDA setup time (stop condition)	t _{SU:STO}	—	4.0	—	—	μs
Bus-free time	t _{BUF}	—	4.7	—	—	μs

When using the I²C as the master, configure the I²C master n mode register(I2MnMOD) and I²C bus 0 mode register (master side, I2UM0MOD) so that meet these specifications.

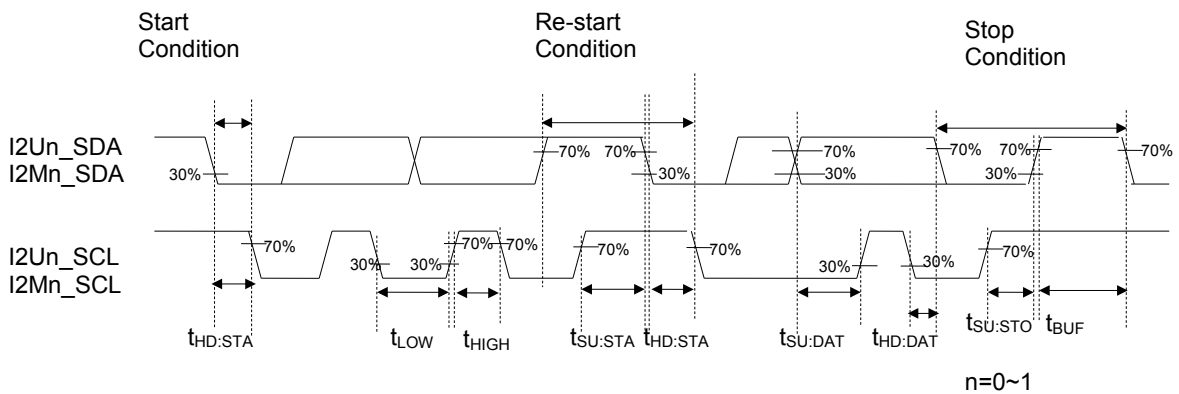

Fast Mode 400kHz

($V_{DD}=1.8$ to $5.5V$, $V_{SS}=0V$, $T_a=-40$ to $+105^{\circ}C$, unless otherwise specified)

Parameter	Symbol	Condition	Min.	Typ.	Max.	Unit
SCL clock frequency	f_{SCL}	—	0	—	400	kHz
SCL hold time (start/restart condition)	$t_{HD:STA}$	—	0.6	—	—	μs
SCL "L" level time	t_{LOW}	—	1.3	—	—	μs
SCL "H" level time	t_{HIGH}	—	0.6	—	—	μs
SCL setup time (restart condition)	$t_{SU:STA}$	—	0.6	—	—	μs
SDA hold time	$t_{HD:DAT}$	—	0	—	—	μs
SDA setup time	$t_{SU:DAT}$	—	0.1	—	—	μs
SDA setup time (stop condition)	$t_{SU:STO}$	—	0.6	—	—	μs
Bus-free time	t_{BUF}	—	1.3	—	—	μs

When using the I²C as the master, configure the I²C master n mode register(I2MnMOD) and I²C bus 0 mode register (master side, I2UM0MOD) so that meet these specifications.

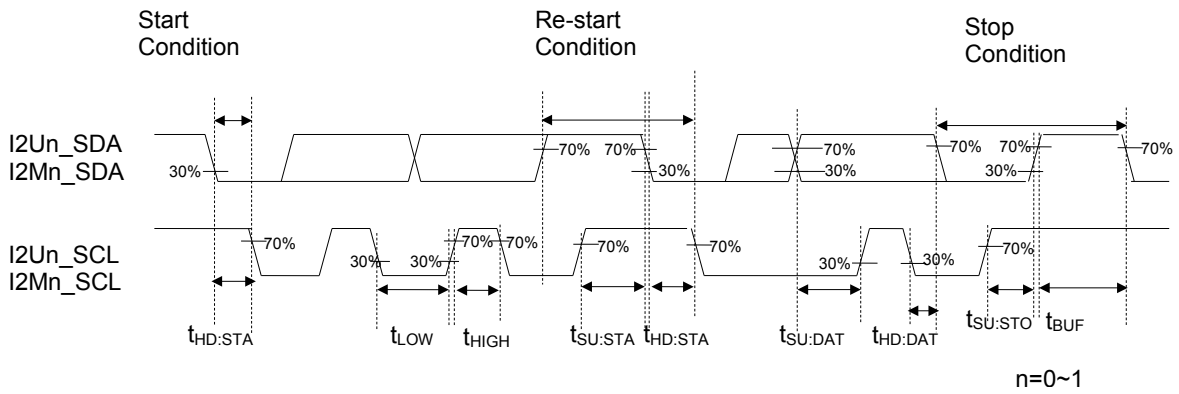

1Mbps Mode

($V_{DD}=2.7$ to $5.5V$, $V_{SS}=0V$, $T_a=-40$ to $+105^{\circ}C$, unless otherwise specified)

Parameter	Symbol	Condition	Min.	Typ.	Max.	Unit
SCL clock frequency	f_{SCL}	—	0	—	1000	kHz
SCL hold time (start/restart condition)	$t_{HD:STA}$	—	0.26	—	—	μs
SCL "L" level time	t_{LOW}	—	0.5	—	—	μs
SCL "H" level time	t_{HIGH}	—	0.26	—	—	μs
SCL setup time (restart condition)	$t_{SU:STA}$	—	0.26	—	—	μs
SDA hold time	$t_{HD:DAT}$	—	0	—	—	μs
SDA setup time	$t_{SU:DAT}$	—	0.1	—	—	μs
SDA setup time (stop condition)	$t_{SU:STO}$	—	0.26	—	—	μs
Bus-free time	t_{BUF}	—	0.5	—	—	μs

When using the I²C as the master, configure the I²C master n mode register(I2MnMOD) and I²C bus 0 mode register (master side, I2UM0MOD) so that meet these specifications.

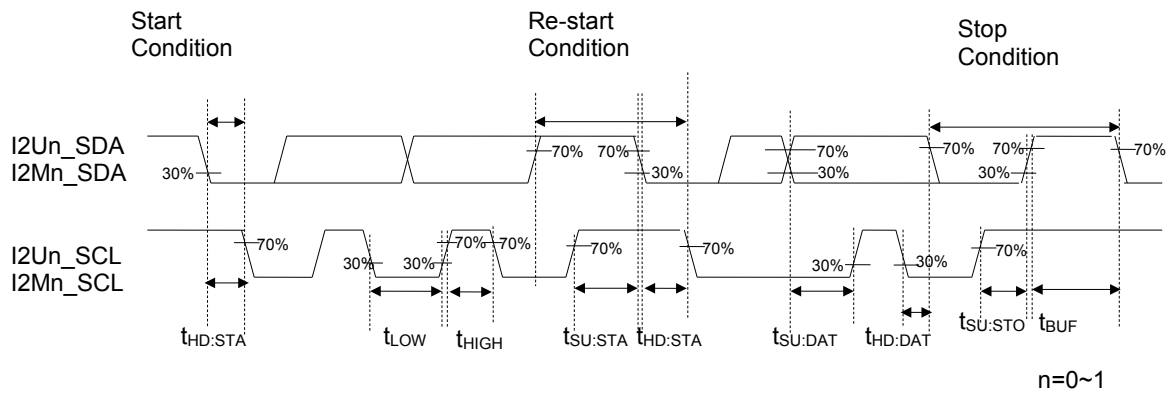

Reset

($V_{DD}=1.6$ to $5.5V$, $V_{SS}=0V$, $T_a=-40$ to $+105^{\circ}C$, unless otherwise specified)

Parameter	Symbol	Condition	Min.	Typ.	Max.	Unit	Measuring circuit
Reset pulse width	P_{RST}	—	2	—	—	ms	1
P00“H” level setup time	t_{SP00}	—	1	—	—	ms	
P00“H” level hold time	t_{HP00}	—	1	—	—	ms	

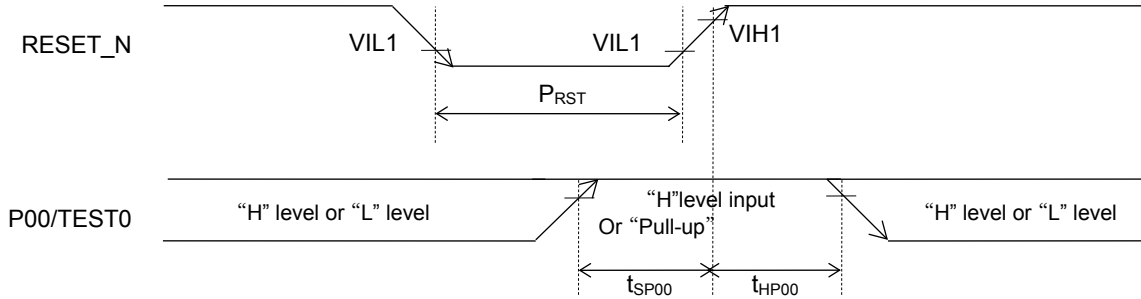

Power On Reset

($V_{SS}=0V$, $T_a=-40$ to $+105^{\circ}C$, unless otherwise specified)

Parameter	Symbol	Condition	Min.	Typ.	Max.	Unit	Measuring circuit
POR detect voltage	V_{POR}	Power down(falling)	1.43	1.49	1.58	V	1
		Power up(rising)	1.47	1.57	1.80	V	
Power on rising slope	R_{POR}^{*1}	—	—	—	60	V/ms	
POR response time	P_{POR}	*2	200	—	—	μs	

*1: Rise the V_{DD} to 1.8V or higher when powering on.

*2: This is the time from the V_{DD} gets 100mV lower than V_{POR} to the Power-On-Reset internally generates. Make the power down falling slope 2V/ms or lower(i.e. slower).

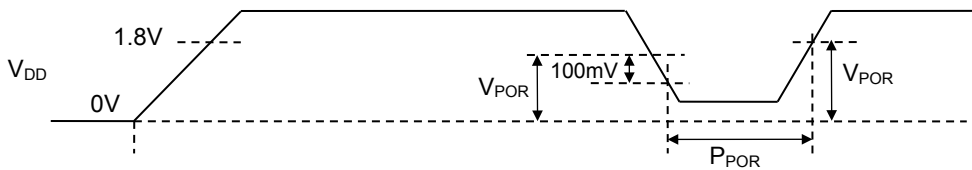

[Note for in case of instantaneous power failure]

In case of instantaneous power failure and a pulse shorter than the response time of VLS or POR is asserted to V_{DD} , it is possible to make the MCU cannot get the reset and make erroneous operation. In that case, please have countermeasures such as preventing the voltage down using bypass capacitor or making reset pin reset.

VLS

(V_{DD}=1.6 to 5.5V, V_{SS}=0V, Ta=-40 to +105°C, unless otherwise specified)

Parameter	Symbol	Condition		Min.	Typ.	Max.	Unit	Measuring circuit
		VLS0LV * ¹						
VLS threshold voltage * ²	V _{VLSR}	00H	Rising	3.86	4.06	4.26	V	1
	V _{VLSF}		Falling	3.84	4.00	4.16		
	V _{VLSR}	01H	Rising	3.57	3.76	3.95		
	V _{VLSF}		Falling	3.55	3.70	3.85		
	V _{VLSR}	02H	Rising	2.94	3.11	3.28		
	V _{VLSF}		Falling	2.92	3.05	3.18		
	V _{VLSR}	03H	Rising	2.85	3.01	3.17		
	V _{VLSF}		Falling	2.83	2.95	3.07		
	V _{VLSR}	04H	Rising	2.75	2.91	3.07		
	V _{VLSF}		Falling	2.73	2.85	2.97		
	V _{VLSR}	05H	Rising	2.66	2.81	2.96		
	V _{VLSF}		Falling	2.64	2.75	2.86		
	V _{VLSR}	06H	Rising	2.56	2.71	2.86		
	V _{VLSF}		Falling	2.54	2.65	2.76		
	V _{VLSR}	07H	Rising	2.46	2.61	2.76		
	V _{VLSF}		Falling	2.44	2.55	2.66		
	V _{VLSR}	08H	Rising	2.37	2.51	2.65		
	V _{VLSF}		Falling	2.35	2.45	2.55		
	V _{VLSR}	09H	Rising	1.98	2.11	2.24		
	V _{VLSF}		Falling	1.96	2.05	2.14		
V _{VLSR}	0AH	Rising	1.89	2.01	2.13			
V _{VLSF}		Falling	1.87	1.95	2.03			
V _{VLSR}	0BH	Rising	1.79	1.91	2.03			
V _{VLSF}		Falling	1.77	1.85	1.93			
VLS Current	I _{VLS}	—		—	50	—	nA	

*¹ Bit3~Bit0 of voltage level detection circuit 0 level register (VLS0LV).*² The Data VLS0LV = 0CH~0FH is not available to use, if the data is specified it will the same spec as that 0BH is specified.

Analog Comparator

(V_{DD}=1.8 to 5.5V, V_{SS}=0V, Ta=-40 to +105°C, unless otherwise specified)

Parameter	Symbol	Condition	Min.	Typ.	Max.	Unit	Measuring circuit
Comparator same phase input voltage range	V _{CMR}	—	0.1	—	V _{DD} -1.5	V	1
Comparator0 input offset	V _{CMOF}	Ta=+25°C, V _{DD} =5.0V	—	5	—	mV	
Comparator Reference Voltage	V _{CMREF}	—	0.75	0.8	0.85	V	

Successive Approximation Type A/D Converter

($V_{DD}=1.8$ to $5.5V$, $V_{SS}=0V$, $T_a=-40$ to $+105^{\circ}C$, unless otherwise specified)

Parameter	Symbol	Condition	Min.	Typ.	Max.	Unit
Resolution	n_{AD}	—	—	—	10	bit
Overall error	—	$4.5V \leq V_{REFP}^{*1} \leq 5.5V$	-3.5	1.2	3.5	LSB
Integral non-linearity error	INL _{AD}	$2.7V \leq V_{REFP}^{*1} \leq 5.5V$	-4	—	4	
		$2.2V \leq V_{REFP}^{*1} < 2.7V$	-6	—	6	
		$1.8V \leq V_{REFP}^{*1} < 2.2V$	-10	—	10	
		V_{REFP} =Internal reference voltage	-15	—	15	
Differential non-linearity error	DNL _{AD}	$2.7V \leq V_{REFP}^{*1} \leq 5.5V$	-3	—	3	
		$2.2V \leq V_{REFP}^{*1} < 2.7V$	-5	—	5	
		$1.8V \leq V_{REFP}^{*1} < 2.2V$	-9	—	9	
		V_{REFP} =Internal reference voltage	-14	—	14	
Zero-scale error	ZSE	$R_I \leq 1k\Omega$	-6	—	6	V
Full-scale error	FSE	$R_I \leq 1k\Omega$	-6	—	6	
A/D reference voltage	V_{REF}	—	1.8	—	V_{DD}	V
Internal reference voltage	V_{REFI}	—	1.5	1.55	1.6	
Conversion time	t_{CONV}	$4.5V \leq V_{DD} \leq 5.5V$	2.25	—	427	μs
		$2.2V \leq V_{DD} \leq 5.5V$	4.5	—	427	
		$1.8V \leq V_{DD} \leq 5.5V$	18	—	427	

*1 : V_{DD} or P23/ V_{REF} is selected for the reference voltage of Successive Approximation Type A/D Converter by setting bit5(VREFP1) and bit4(VREFP0) of Reference voltage control register (VREFCON).

The current flows during the ADC sampling as it takes charging. Make the output impedance of the analog signal source $1k\Omega$ or smaller. Also, putting $0.1\mu F$ capacitor on the ADC input pin is recommended to reduce the noise.

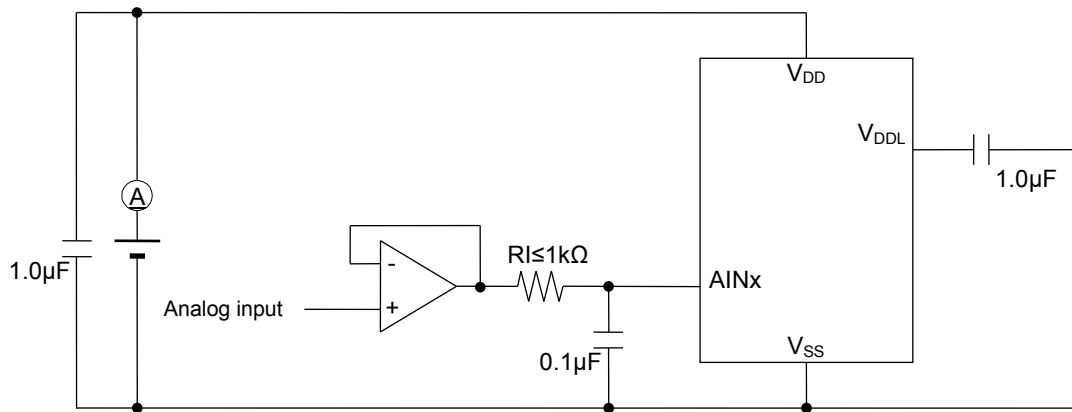

D/A Converter

(V_{DD}=1.8 to 5.5V, V_{SS}=0V, Ta=-40 to +105°C, unless otherwise specified)

Parameter	Symbol	Condition	Min.	Typ.	Max.	Unit
Resolution	n _{DA}	—	—	—	8	bit
Conversion cycle	t _C	—	10	—	—	μs
Integral non-linearity error	INL _{DA}	RL=4MΩ	-2	—	2	LSB
Differential non-linearity error	DNL _{DA}	RL=4MΩ	-1	—	1	
Output impedance	R _O	DACEN bit of D/A converter enable register =1	3	6	9	kΩ

Reference Voltage Output

(V_{DD}=1.8 to 5.5V, V_{SS}=0V, Ta=-40 to +105°C, unless otherwise specified)

Parameter	Symbol	Condition	Min.	Typ.	Max.	Unit
Output voltage	V _{REFO}	—	—	1.55	—	V
Output impedance	R _{VREFO}	—	—	—	500	kΩ

Flash Memory

(V_{SS}= 0V)

Parameter	Symbol	Condition	Range	Unit
Operating temperature	T _{OP}	Data flash memory, At write/erase	-40 to +85	°C
		Flash ROM, At write/erase	0 to +40	
Operating voltage	V _{DD}	At write/erase	+1.8 to +5.5	V
Maximum rewrite count	CEPD	Data Flash	10000	times
	CEPP	Program Flash	100	
Erase unit	—	Block erase	Program Flash	16K
			Data Flash	all area
	—	Sector erase	Program Flash	1K
			Data Flash	128
Erase time (Max.)	—	Block erase / Sector erase	50	ms
Write unit	—	Program Flash	4	B
		Data Flash	1	
Write time (Max.)	—	Program Flash	80	μs
	—	Data Flash	40	
Data retention period	YDR	—	15	years

LCD Driver

(V_{DD}=1.8 to 5.5V, V_{SS}=0V, Ta=-40 to +105°C, unless otherwise specified)

Parameter	Symbol	Condition	Range			Unit	Measuring circuit
			LCN ^{*1}	Min.	Typ.		
V _{L1} Voltage	V _{L1}	Ta=+25°C C _{L1,L2,L3} =1.0μF	00H	Typ. -0.05	0.950	Typ. +0.05	V
			01H		0.975		
			02H		1.000		
			03H		1.025		
			04H		1.050		
			05H		1.075		
			06H		1.100		
			07H		1.125		
			08H		1.150		
			09H		1.175		
			0AH		1.200		
			0BH		1.225		
			0CH		1.250		
			0DH		1.275		
			0EH		1.300		
			0FH		1.325		
			10H		1.350		
			11H		1.375		
			12H		1.400		
			13H		1.425		
14H	1.450						
15H	1.475						
16H	1.500						
17H	1.525						
18H	1.550						
19H	1.575						
1AH	1.600						
1BH	1.625						
1CH	1.650						
1DH	1.675						
1EH	1.700						
1FH	1.725						
V _{L2} Voltage	V _{L2}	Ta=+25°C C _{L1,C2,C3} =1.0μF C ₁₂ =1.0μF		V _{L1} x 1.8	V _{L1} x 2	—	V
V _{L3} Voltage	V _{L3}			V _{L1} x 2.7	V _{L1} x 3	—	
Bias generation circuit start-up time	t _{BIAS}			—	—	200	ms

6

*1: Value in LCN4~LCN0 bits of bias control register (BIASCON)

Measuring circuit

Measuring circuit 1

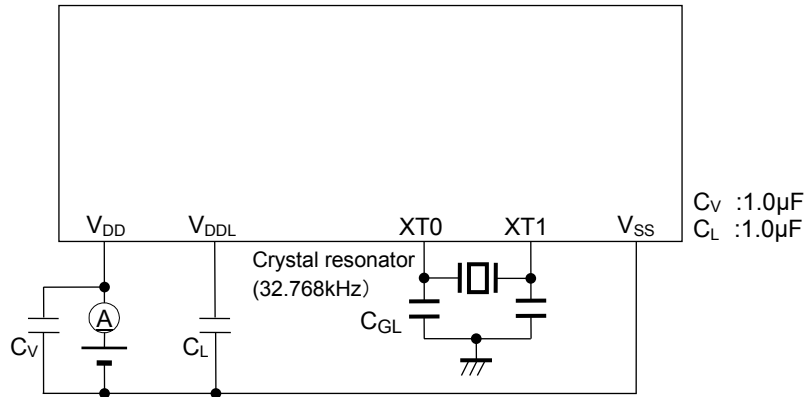

Measuring circuit 2

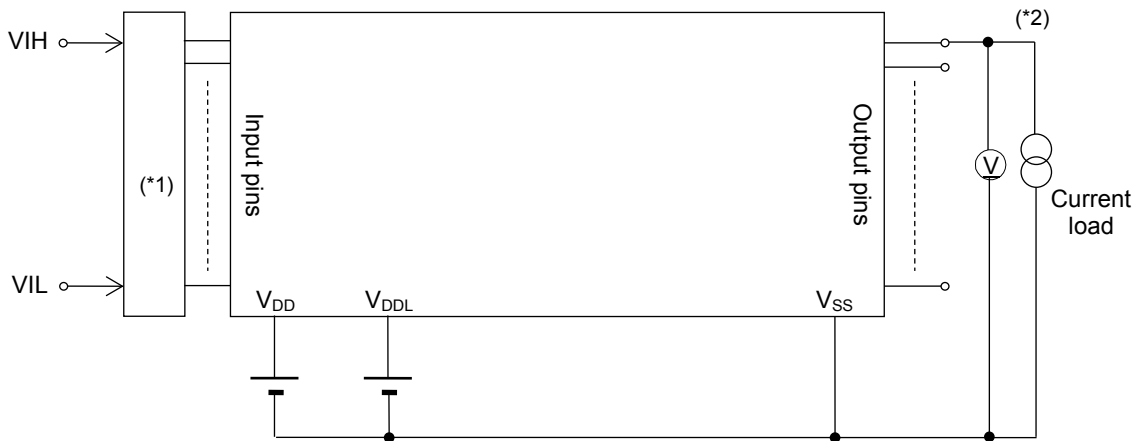

(*1) Input logic circuit to determine the specified measuring conditions
 (*2) Measured connecting specified pins

Measuring circuit 3

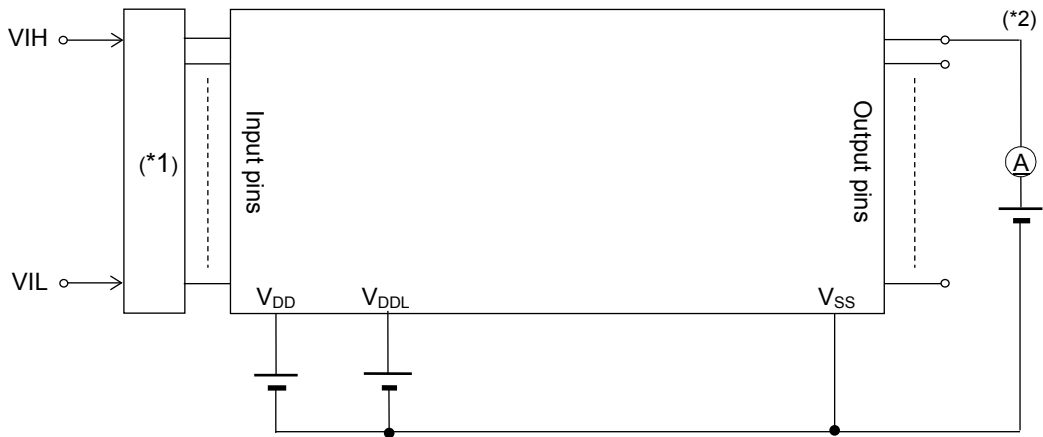

(*1) Input logic circuit to determine the specified measuring conditions
 (*2) Measured connecting specified pins

Measuring circuit 4

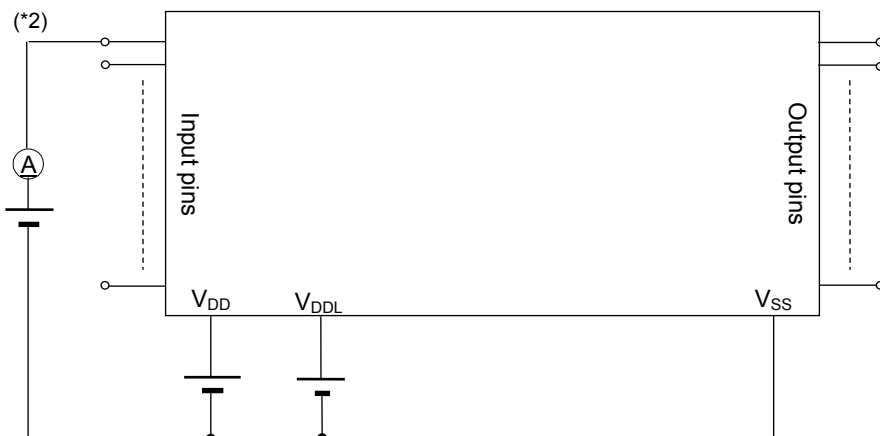

(*2) Measured connecting specified pins

Measuring circuit 5

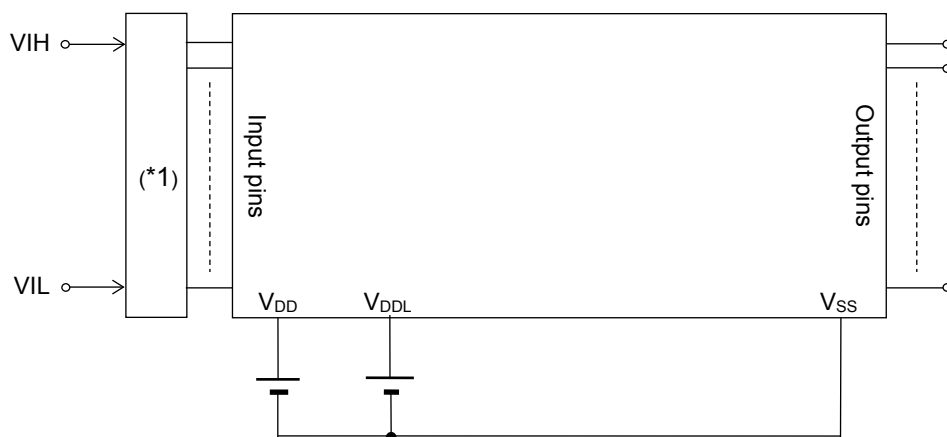

(*1) Input logic circuit to determine the specified measuring conditions

Measuring circuit 6

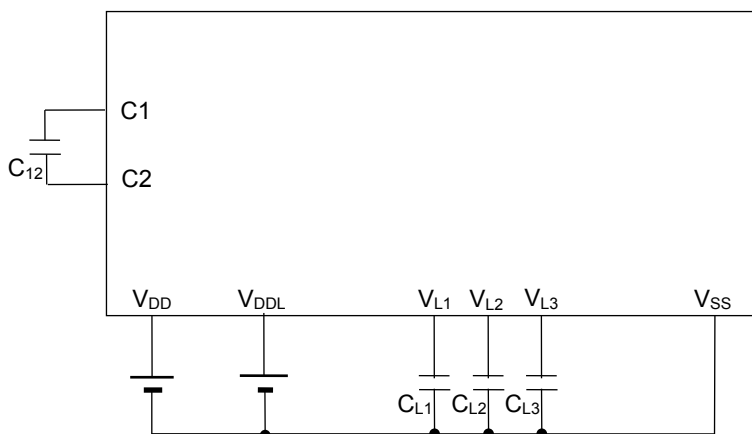

Characteristics graphs

These Graphs on the following pages are references for designing an application.

IOH vs VDD-VOH1 (VDD=5V TYP.)

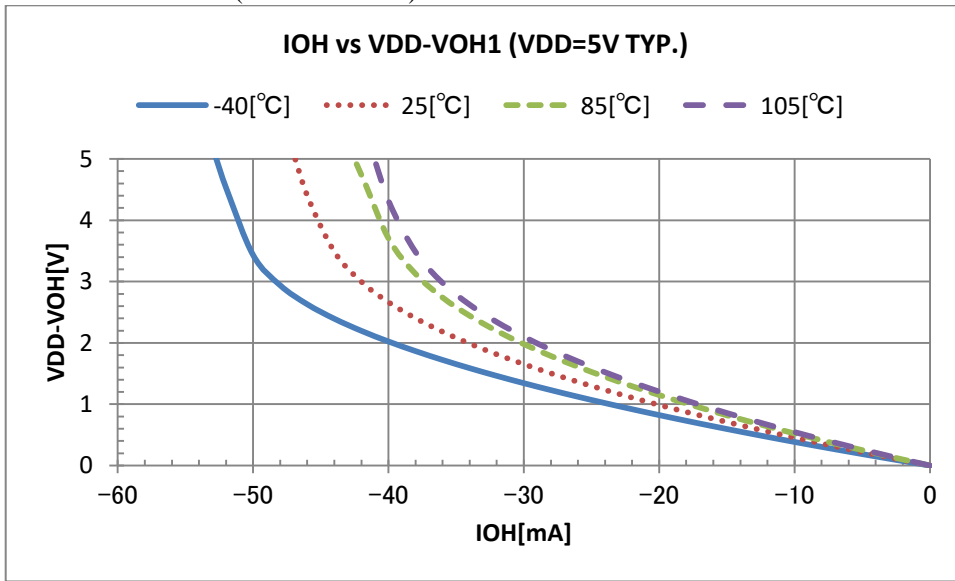

IOH vs VDD-VOH1 (VDD=3V TYP.)

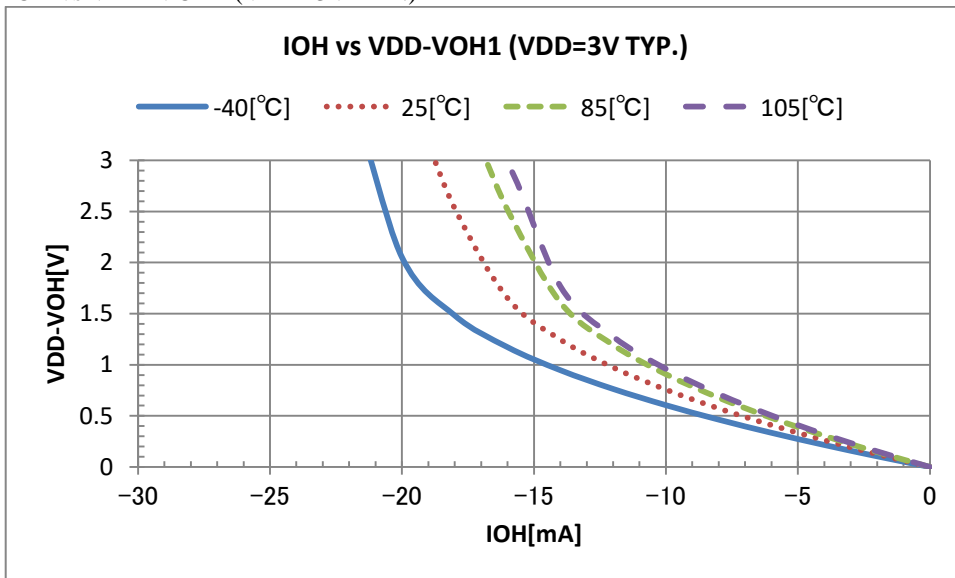

IOL vs VOL1 (VDD=5V TYP.)

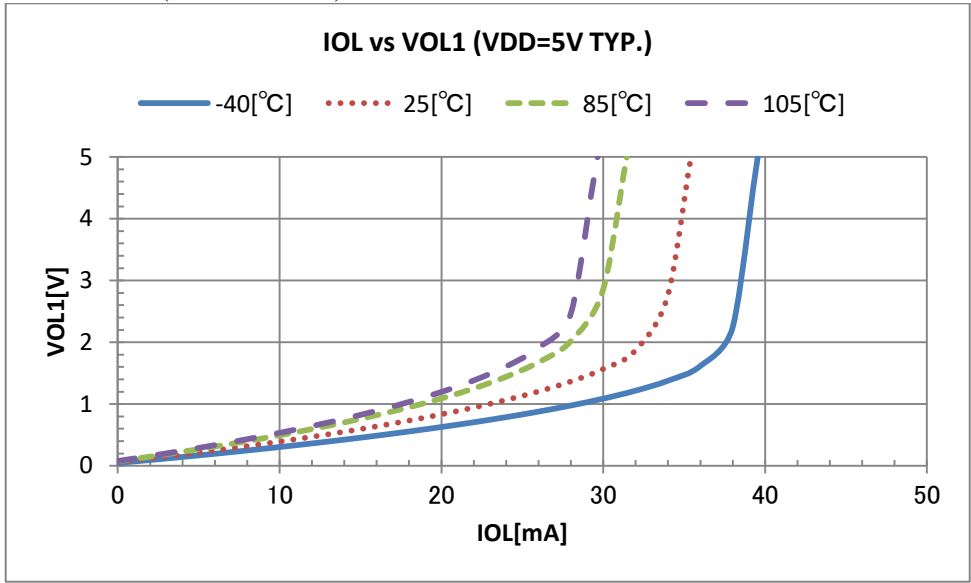

IOL vs VOL1 (VDD=3V TYP.)

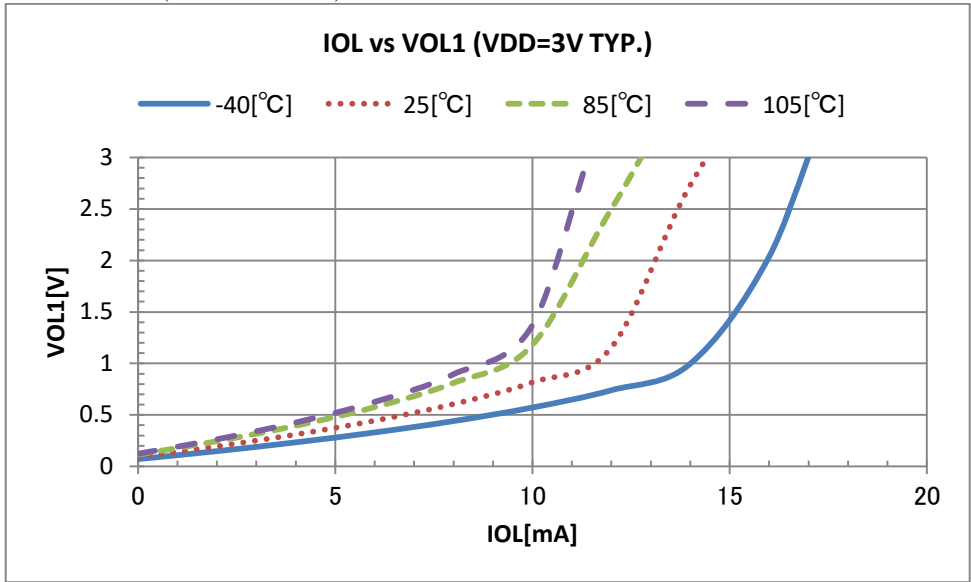

IOL vs VOL2 (VDD=5V TYP.)

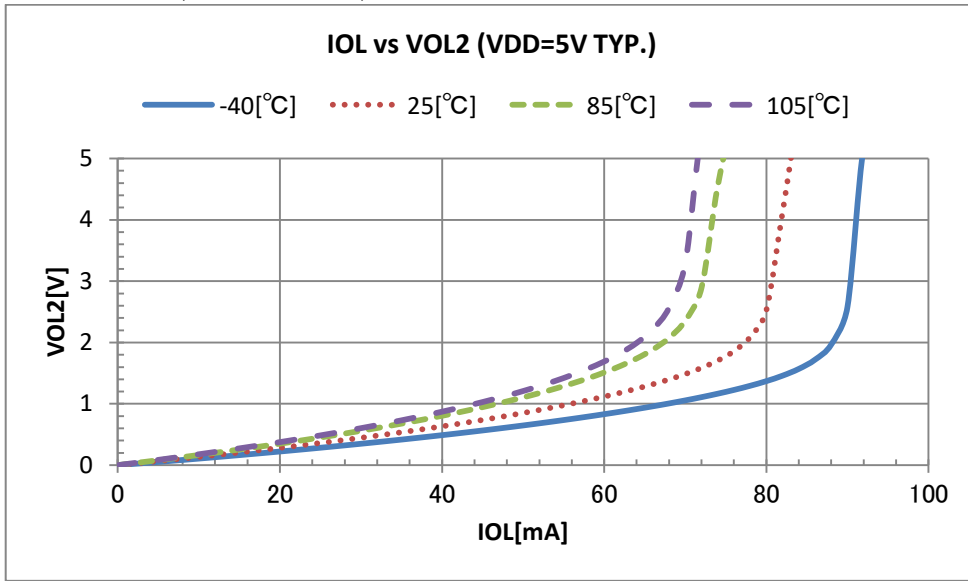

IOL vs VOL2 (VDD=3V TYP.)

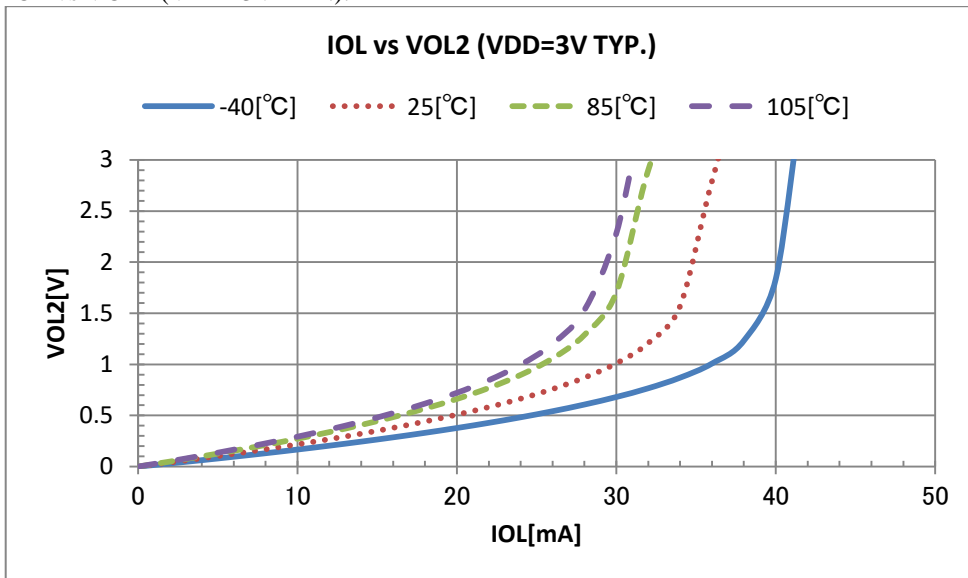

VDD VS IIL2 (TYP. VIL2=VSS)

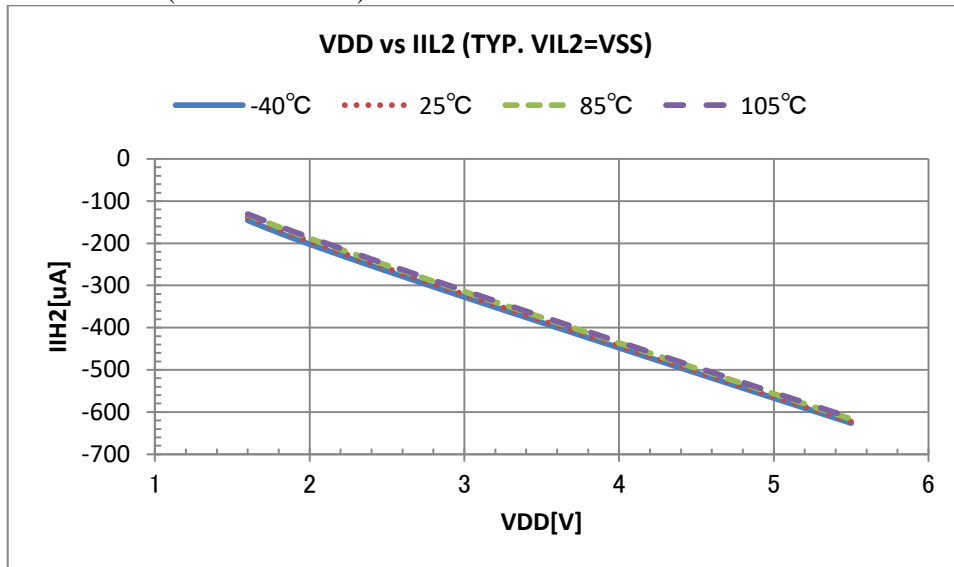

Pull-up resistor

VDD VS VDD/IIL2 (TYP. VIL2=VSS)

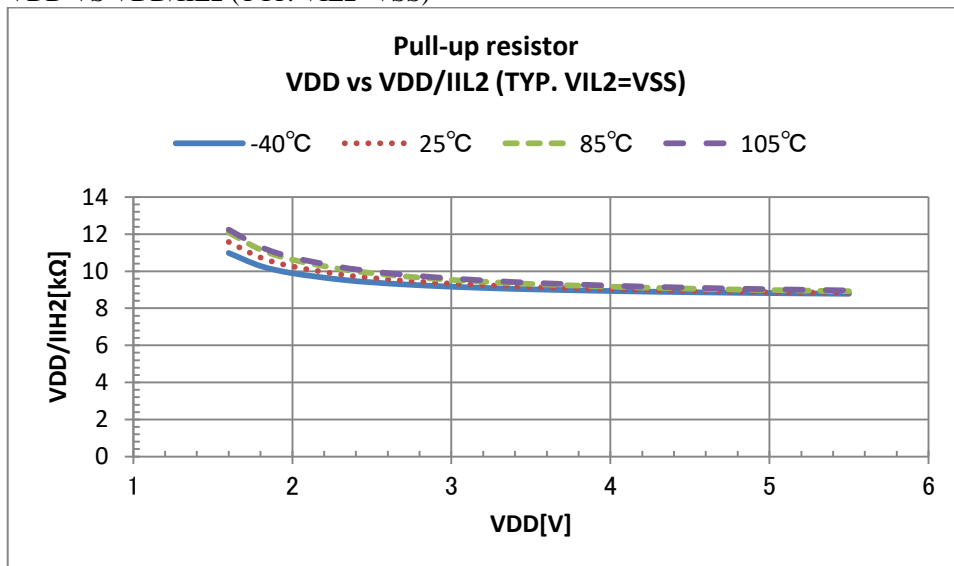

VDD vs IIL3 (TYP. VIL3=VSS)

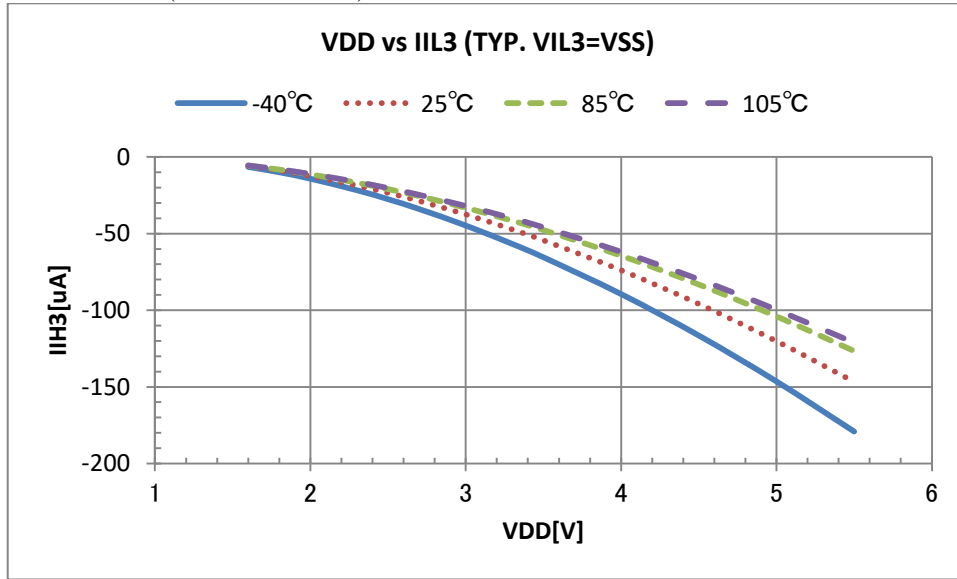

Pull-up resistor

VDD vs VDD/IIL3 (TYP. VIL3=VSS)

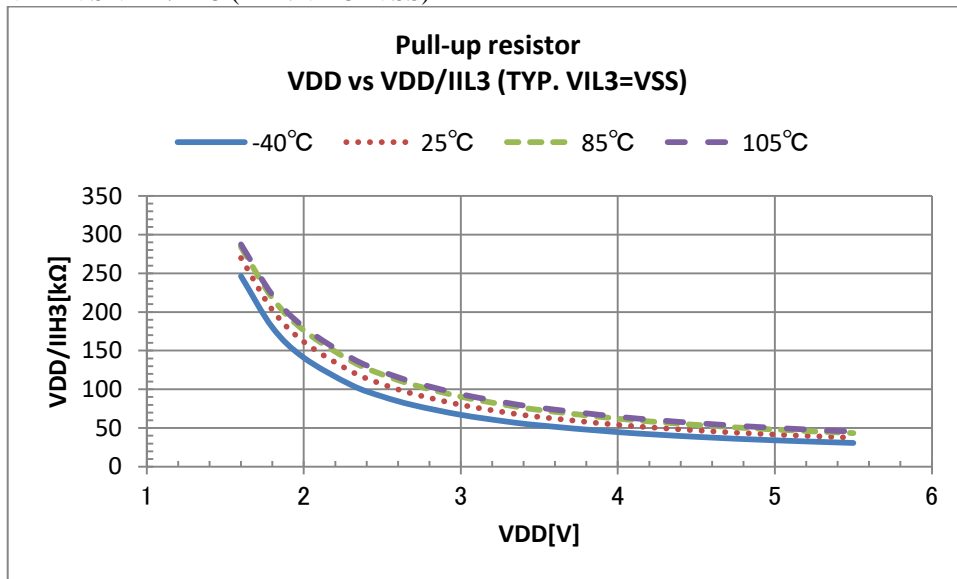

Product: ML62Q1700, ML62Q1701, ML62Q1702, ML62Q1703, ML62Q1704, ML62Q1710, ML62Q1711, ML62Q1712, ML62Q1713, ML62Q1714, ML62Q1720, ML62Q1721, ML62Q1722, ML62Q1723, ML62Q1724

Current consumption VS operating frequency of CPU
VDD=3V, temp=25°C CPU 16MHz Wait mode (TYP.)
Stop the clock supply to peripherals.

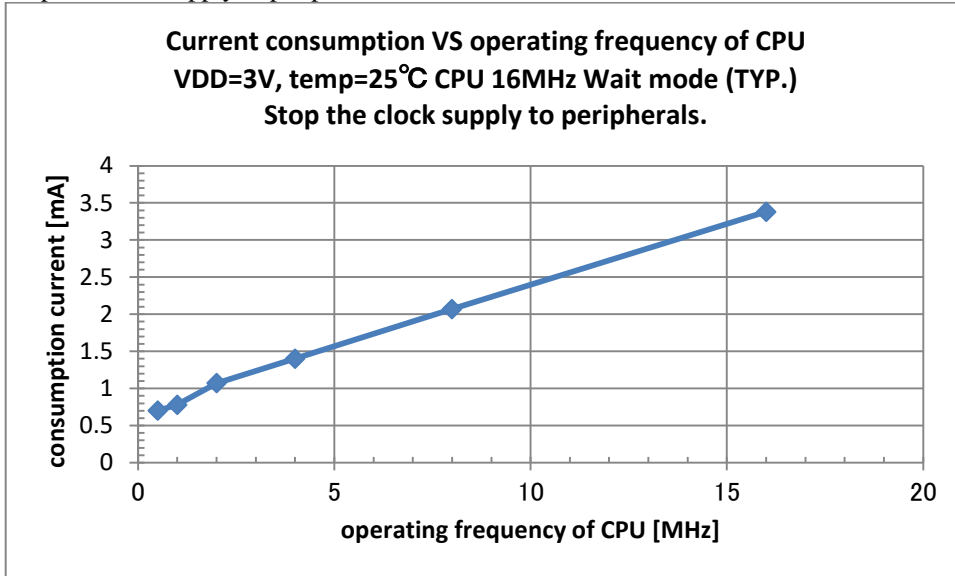

VDD=3V, temp=25°C CPU 16MHz no Wait mode (TYP.)

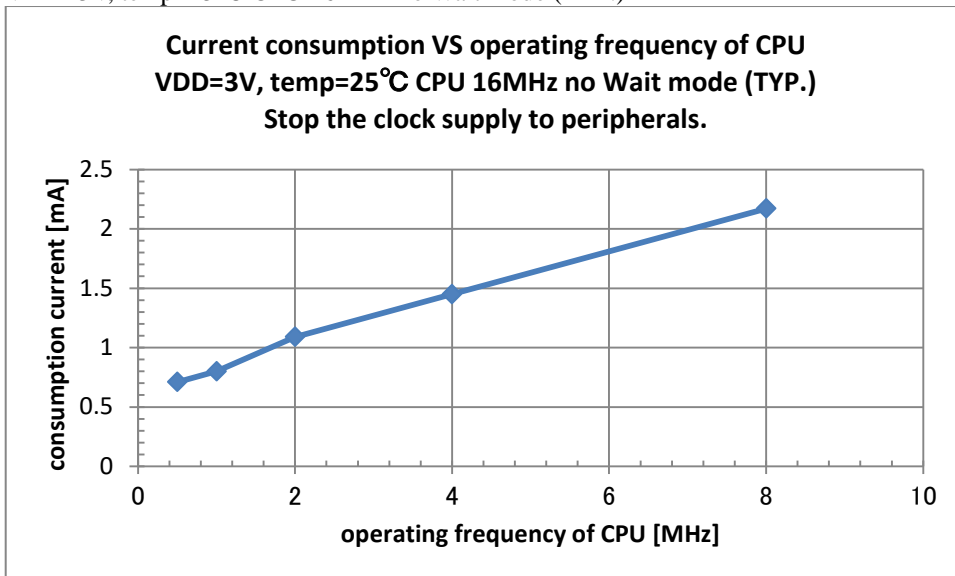

Product: ML62Q1700, ML62Q1701, ML62Q1702, ML62Q1703, ML62Q1704, ML62Q1710, ML62Q1711, ML62Q1712, ML62Q1713, ML62Q1714, ML62Q1720, ML62Q1721, ML62Q1722, ML62Q1723, ML62Q1724

Current consumption VS operating frequency of CPU
 VDD=3V, temp=25°C CPU 24MHz Wait mode (TYP.)
 Stop the clock supply to peripherals.

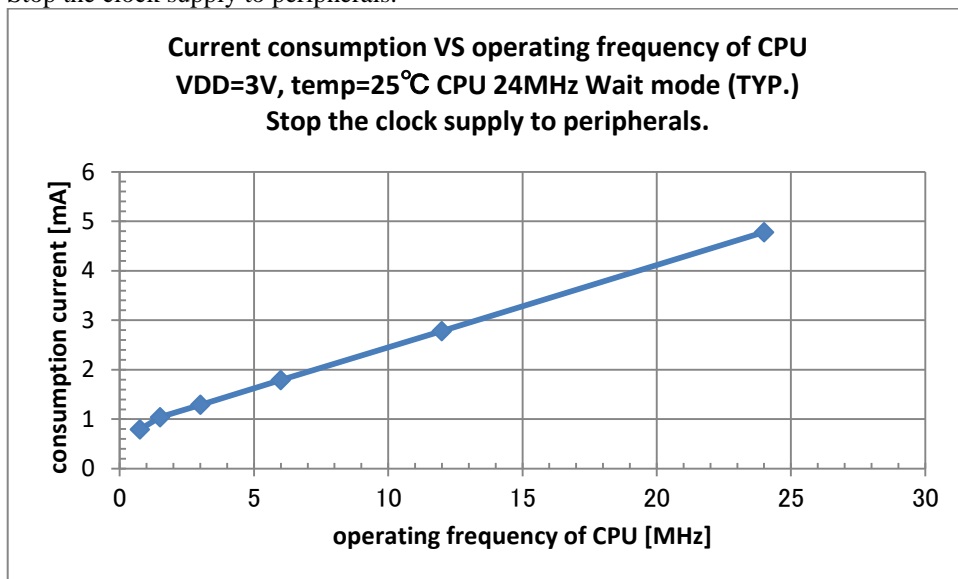

VDD=3V, temp=25°C CPU 24MHz no Wait mode (TYP.)

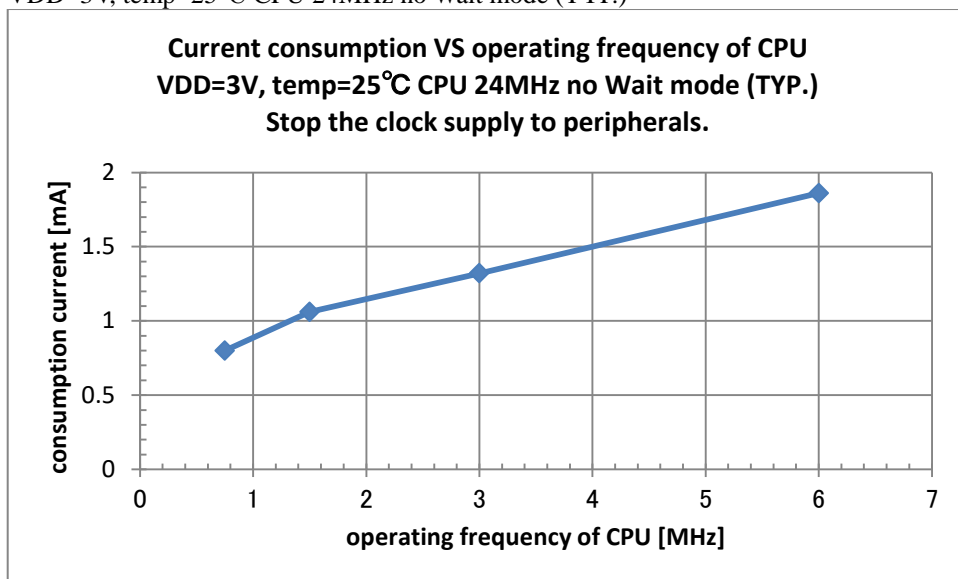

Product: ML62Q1725, ML62Q1726, ML62Q1727,
ML62Q1733, ML62Q1734, ML62Q1735, ML62Q1736, ML62Q1737
ML62Q1743, ML62Q1744, ML62Q1745, ML62Q1746, ML62Q1747

Current consumption VS operating frequency of CPU
VDD=3V, temp=25°C CPU 16MHz Wait mode (TYP.)
Stop the clock supply to peripherals.

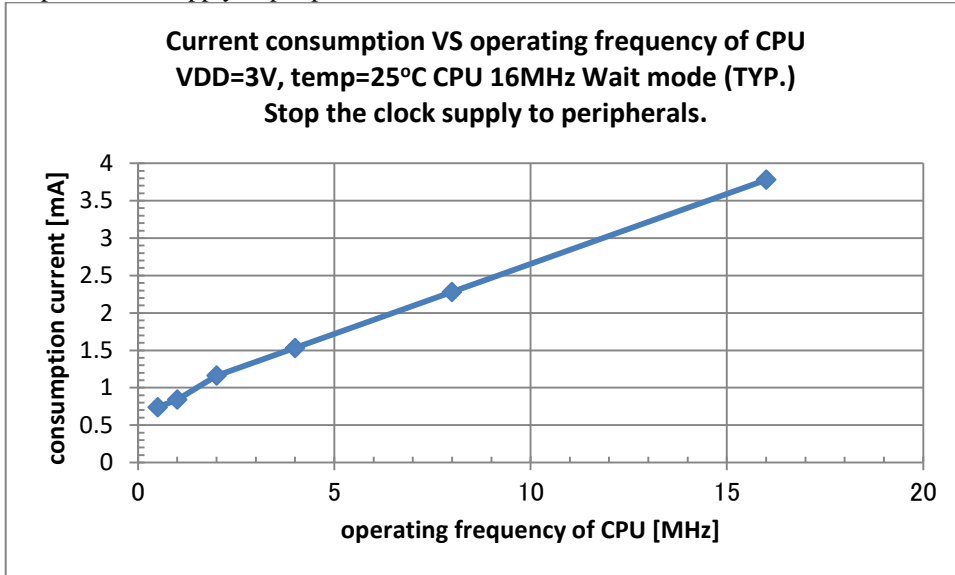

VDD=3V, temp=25°C CPU 16MHz no Wait mode (TYP.)

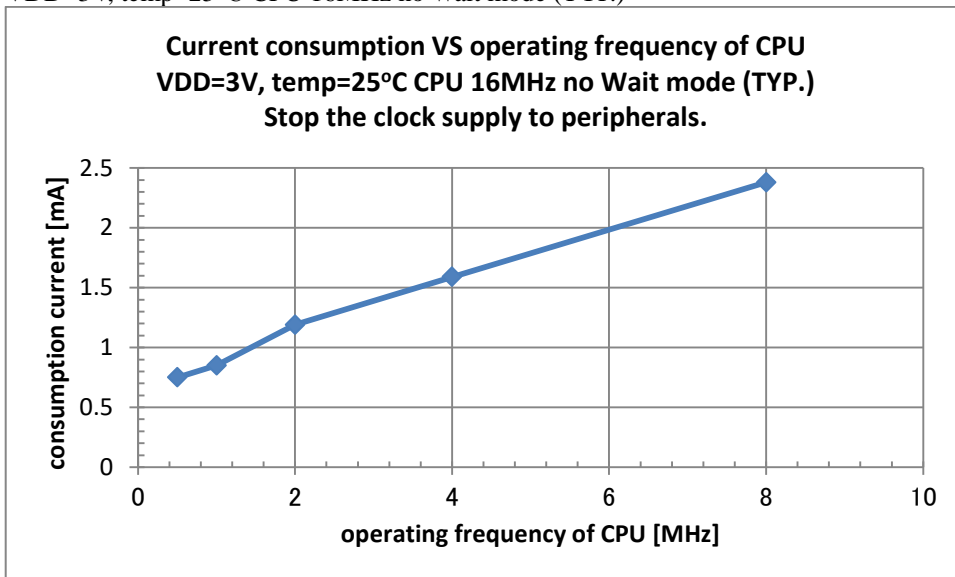

Product: ML62Q1725, ML62Q1726, ML62Q1727,
ML62Q1733, ML62Q1734, ML62Q1735, ML62Q 1736, ML62Q1737
ML62Q1743, ML62Q1744, ML62Q1745, ML62Q 1746, ML62Q1747

Current consumption VS operating frequency of CPU
VDD=3V, temp=25°C CPU 24MHz Wait mode (TYP.)
Stop the clock supply to peripherals.

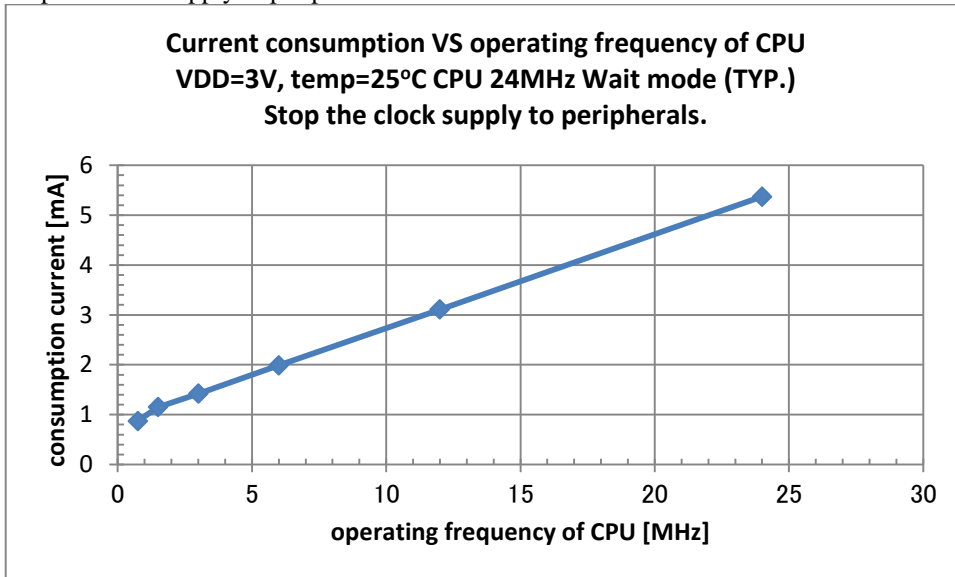

VDD=3V, temp=25°C CPU 24MHz no Wait mode (TYP.)

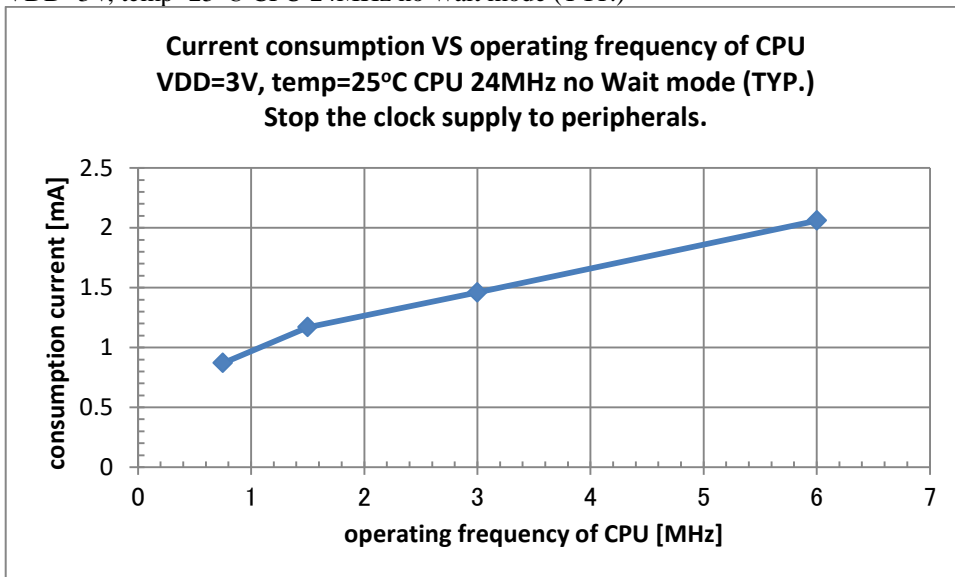

Product: ML62Q1728, ML62Q1729, ML62Q1738, ML62Q1739, ML62Q1748, ML62Q1749

Current consumption VS operating frequency of CPU
VDD=3V, temp=25°C CPU 16MHz Wait mode (TYP.)
Stop the clock supply to peripherals.

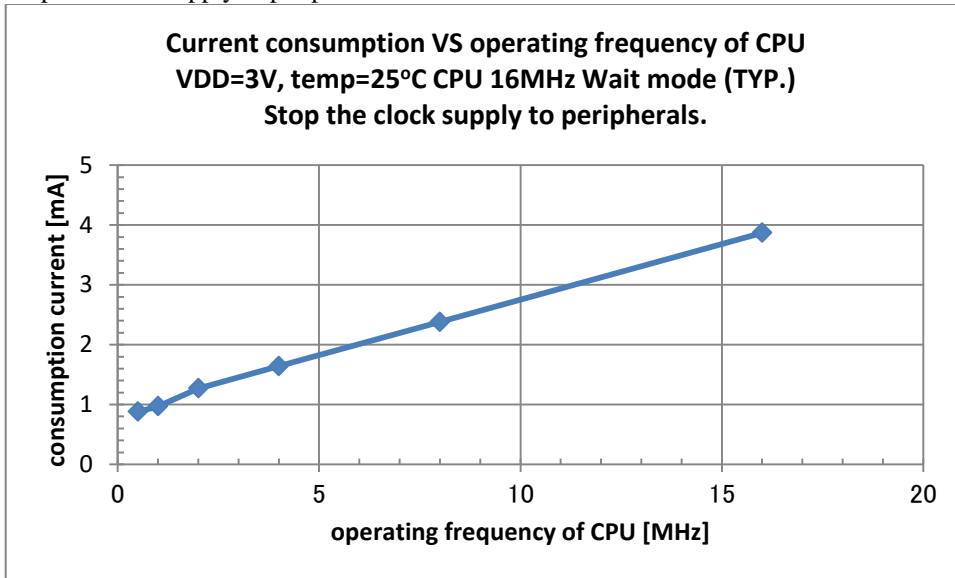

VDD=3V, temp=25°C CPU 16MHz no Wait mode (TYP.)

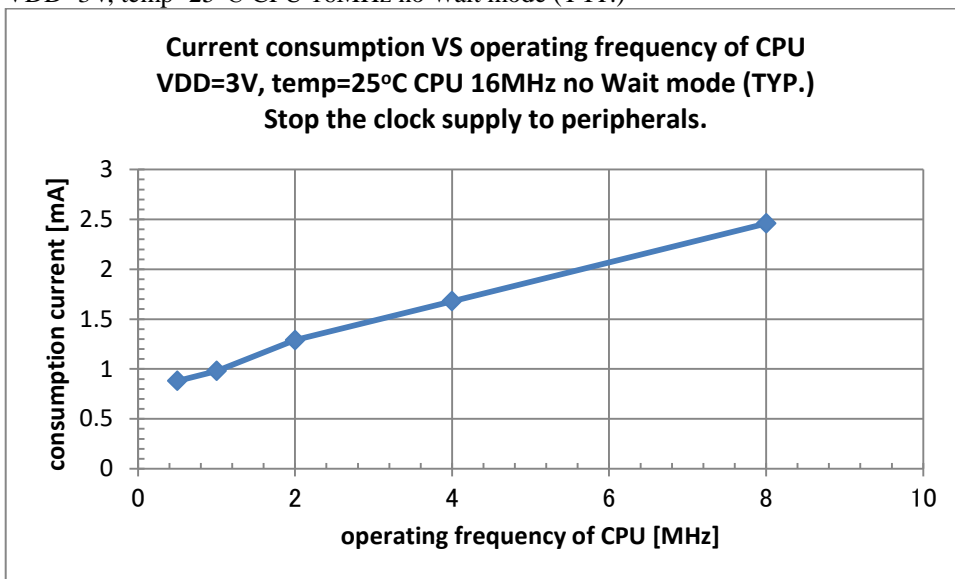

Product: ML62Q1728, ML62Q1729, ML62Q1738, ML62Q1739, ML62Q1748, ML62Q1749

Current consumption VS operating frequency of CPU
VDD=3V, temp=25°C CPU 24MHz Wait mode (TYP.)
Stop the clock supply to peripherals.

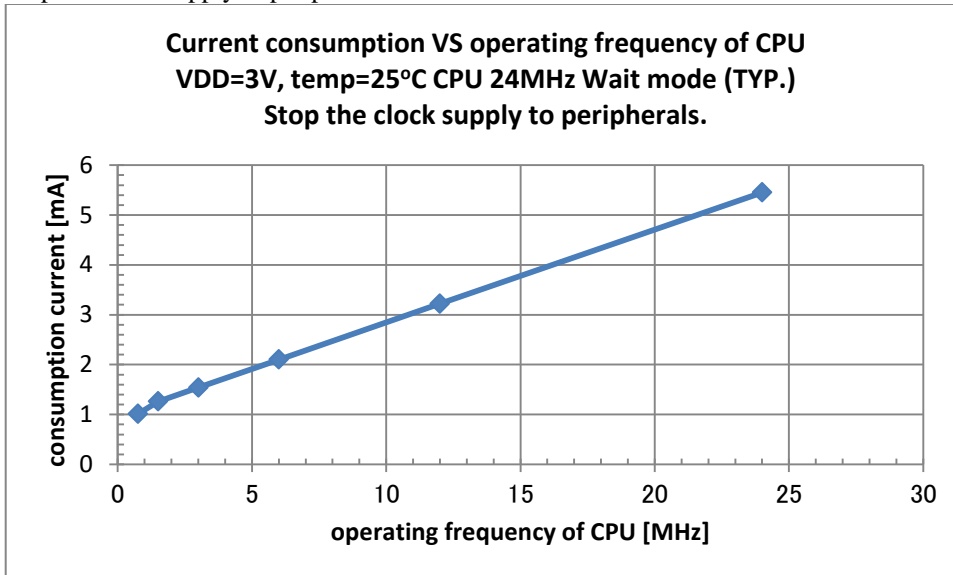

VDD=3V, temp=25°C CPU 24MHz no Wait mode (TYP.)

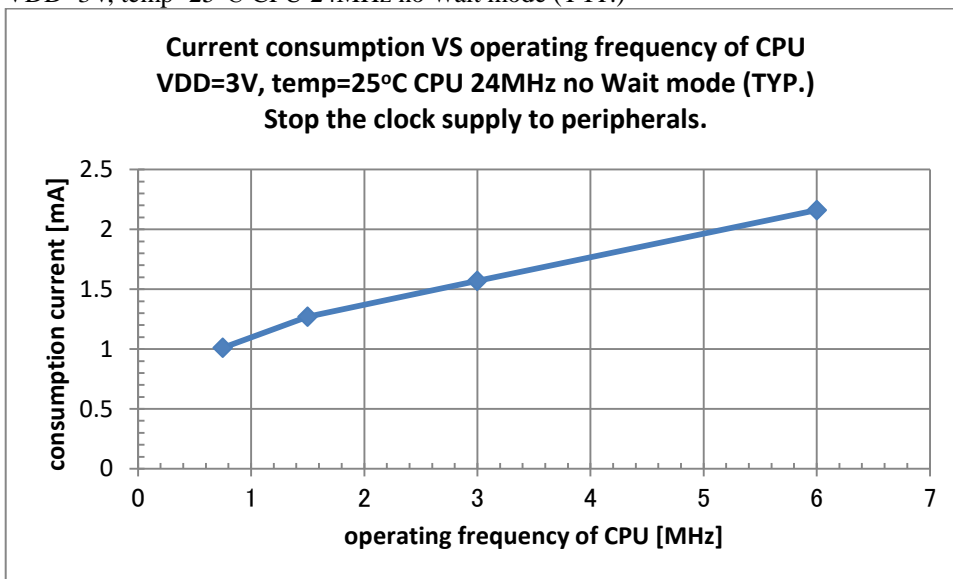

Consumption current of ADC VS operating voltage
PLL frequency=16MHz temp=25°C ch0 VREF=VDD

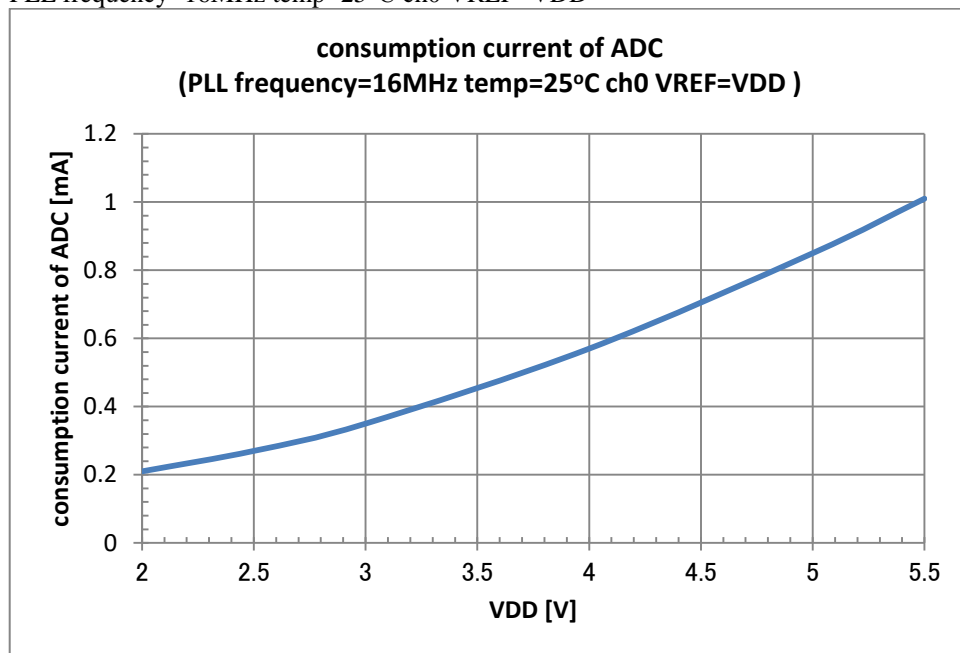

TEMP VS Low-speed RC oscillator frequency accuracy 1 without software adjustment (Typ.)

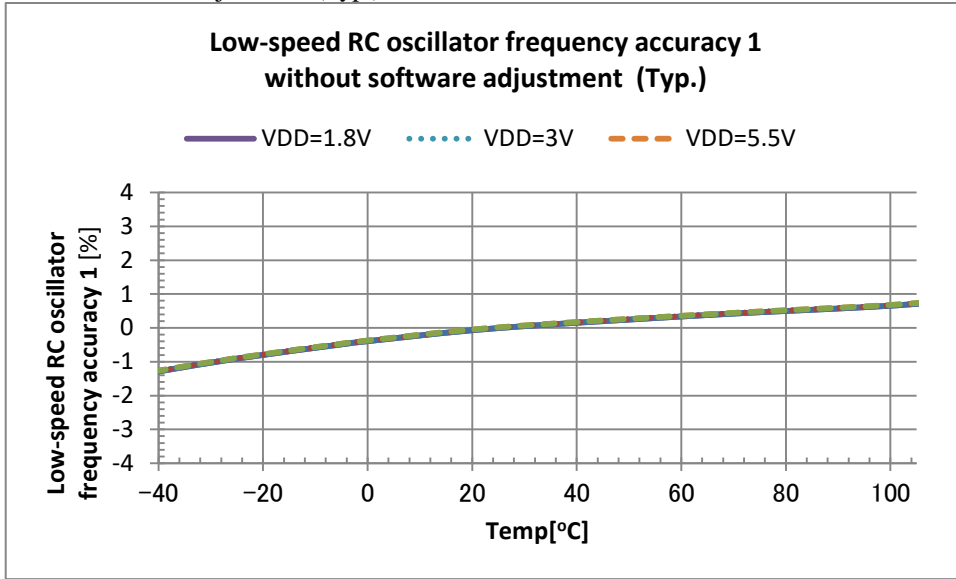

TEMP VS PLL oscillator frequency accuracy 1 without software adjustment (24MHz Typ.)

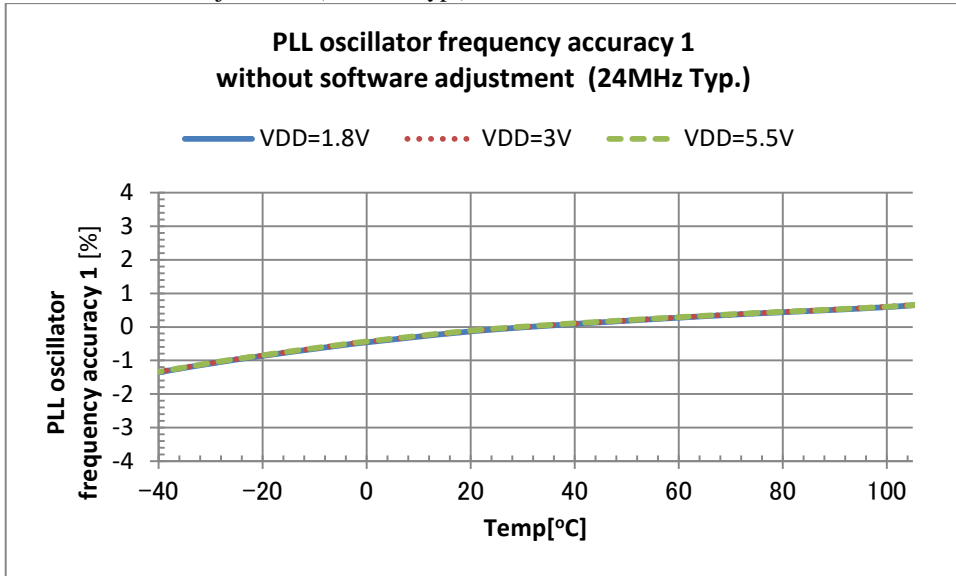

PACKAGE DIMENSIONS

48pin TQFP Package

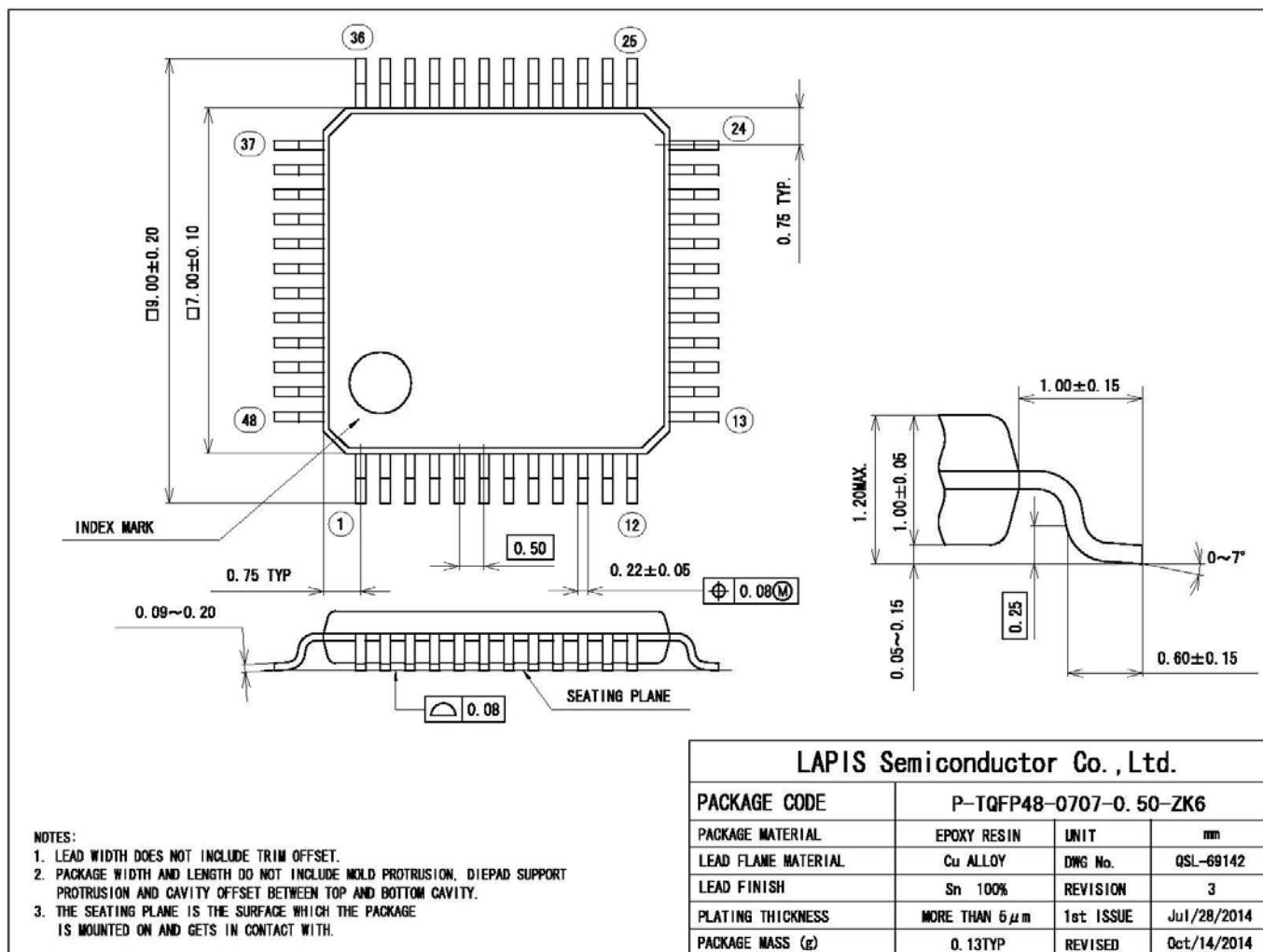

(Unit: mm)

Notes for Mounting the Surface Mount Type Package

The surface mount type packages are very susceptible to heat in reflow mounting and humidity absorbed in storage. Therefore, before you perform reflow mounting, contact a ROHM sales office for the product name, package name, pin number, package code and desired mounting conditions (reflow method, temperature and times).

52pin TQFP Package

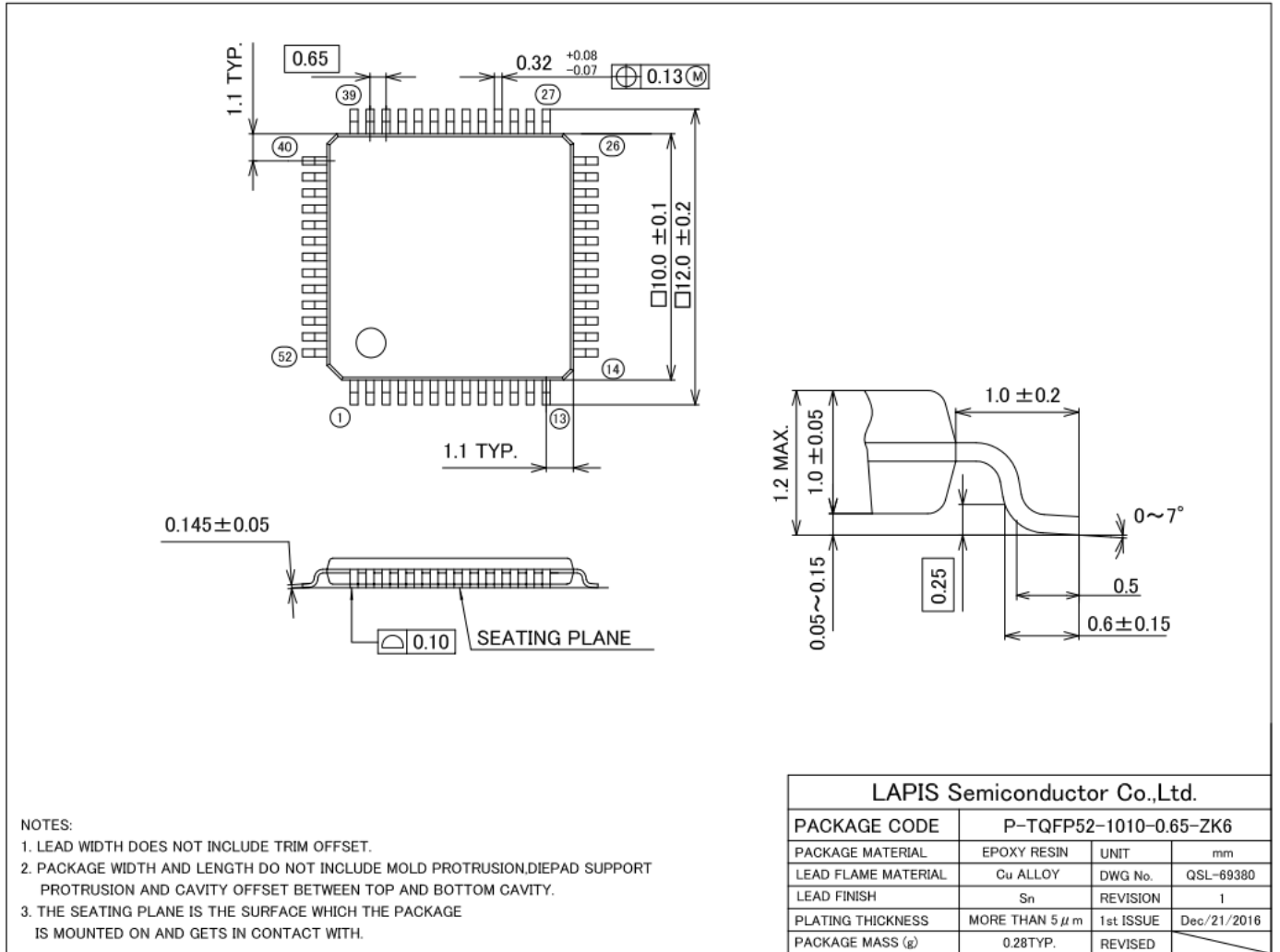

(Unit: mm)

Notes for Mounting the Surface Mount Type Package

The surface mount type packages are very susceptible to heat in reflow mounting and humidity absorbed in storage. Therefore, before you perform reflow mounting, contact a ROHM sales office for the product name, package name, pin number, package code and desired mounting conditions (reflow method, temperature and times).

64pin TQFP Package

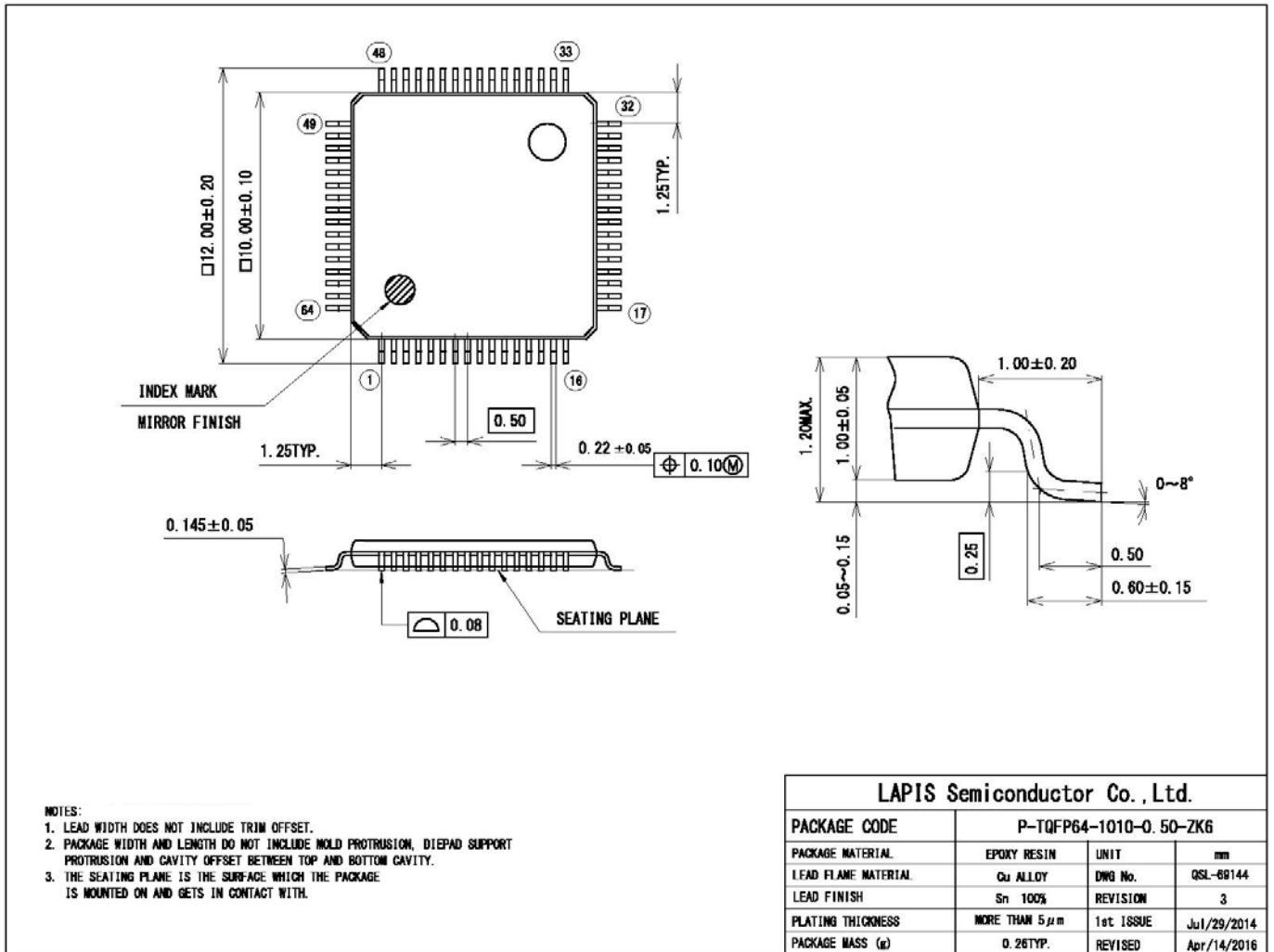

(Unit: mm)

Notes for Mounting the Surface Mount Type Package

The surface mount type packages are very susceptible to heat in reflow mounting and humidity absorbed in storage. Therefore, before you perform reflow mounting, contact a ROHM sales office for the product name, package name, pin number, package code and desired mounting conditions (reflow method, temperature and times).

64pin QFP Package

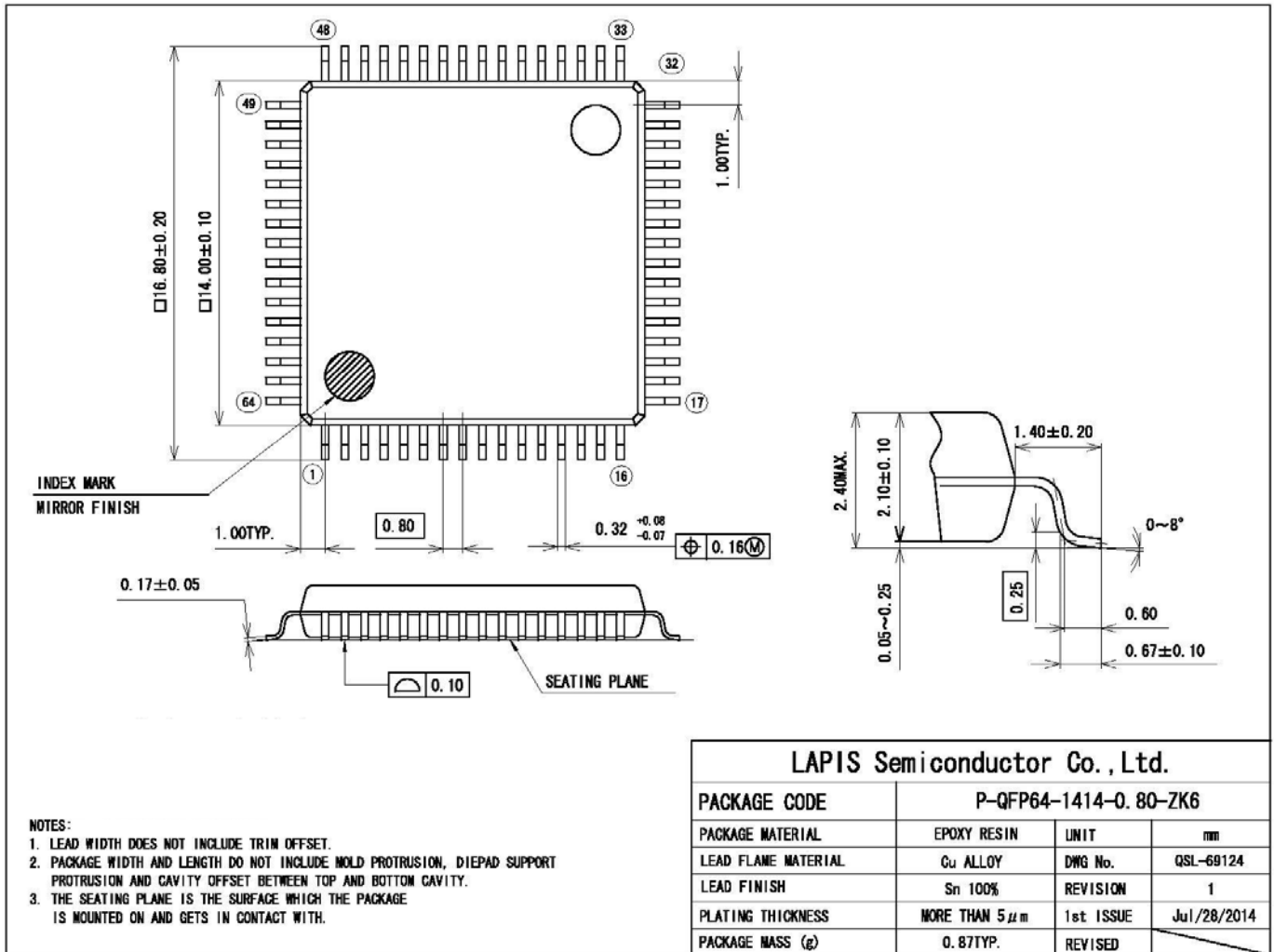

(Unit: mm)

Notes for Mounting the Surface Mount Type Package

The surface mount type packages are very susceptible to heat in reflow mounting and humidity absorbed in storage. Therefore, before you perform reflow mounting, contact a ROHM sales office for the product name, package name, pin number, package code and desired mounting conditions (reflow method, temperature and times).

80pin QFP Package

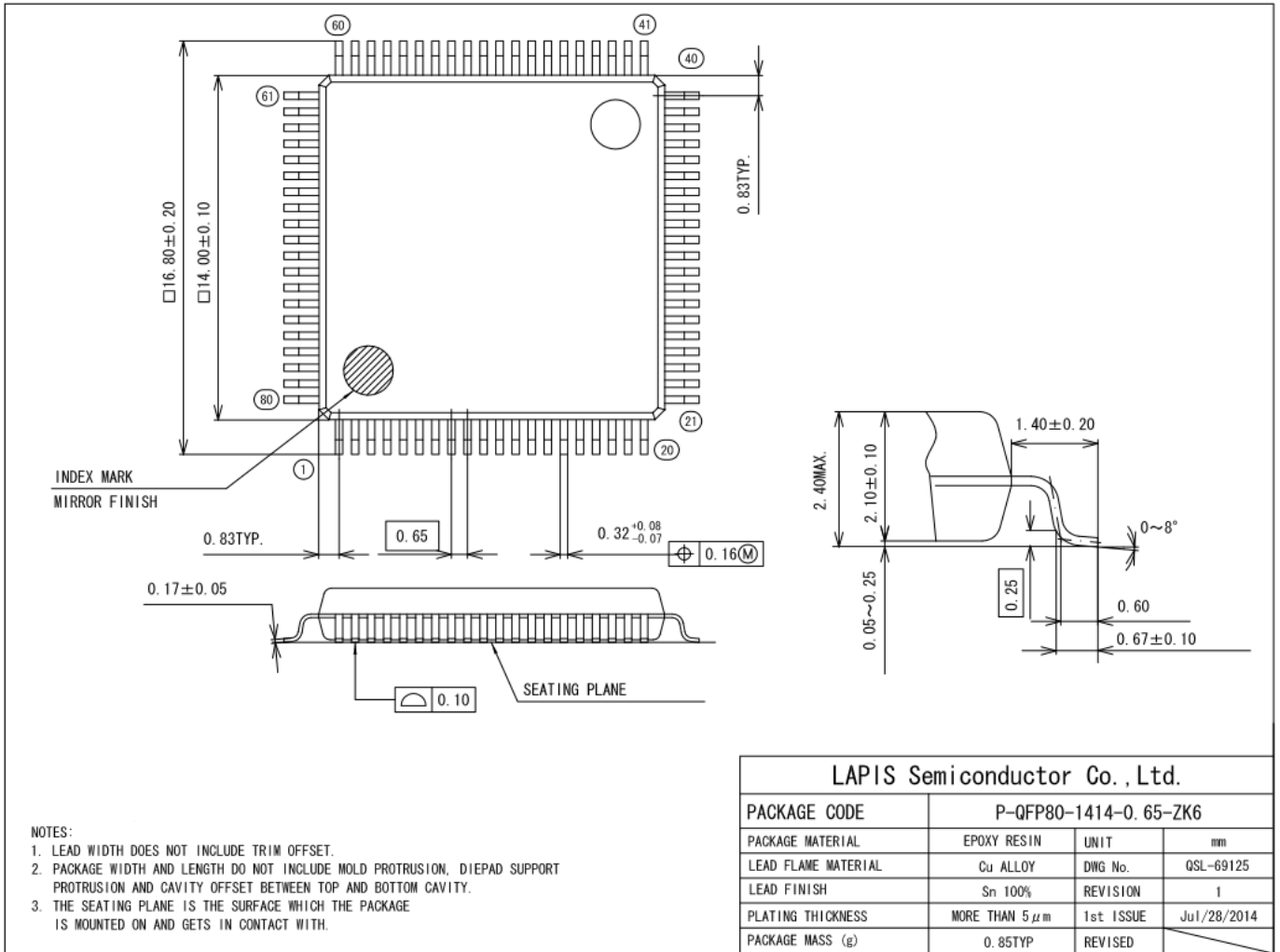

(Unit: mm)

Notes for Mounting the Surface Mount Type Package

The surface mount type packages are very susceptible to heat in reflow mounting and humidity absorbed in storage. Therefore, before you perform reflow mounting, contact a ROHM sales office for the product name, package name, pin number, package code and desired mounting conditions (reflow method, temperature and times).

100pin TQFP Package

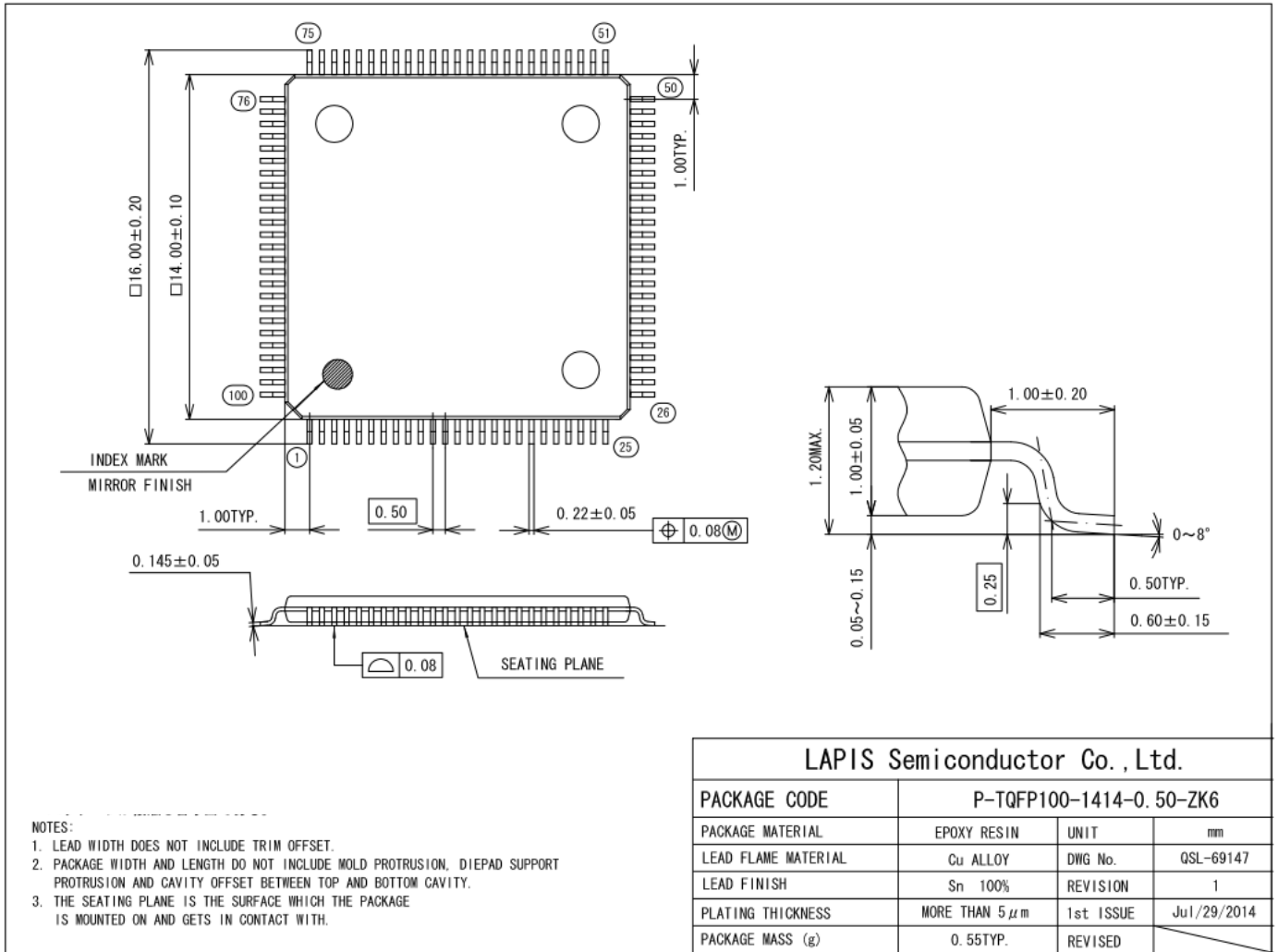

(Unit: mm)

Notes for Mounting the Surface Mount Type Package

The surface mount type packages are very susceptible to heat in reflow mounting and humidity absorbed in storage. Therefore, before you perform reflow mounting, contact a ROHM sales office for the product name, package name, pin number, package code and desired mounting conditions (reflow method, temperature and times).

100pin QFP Package

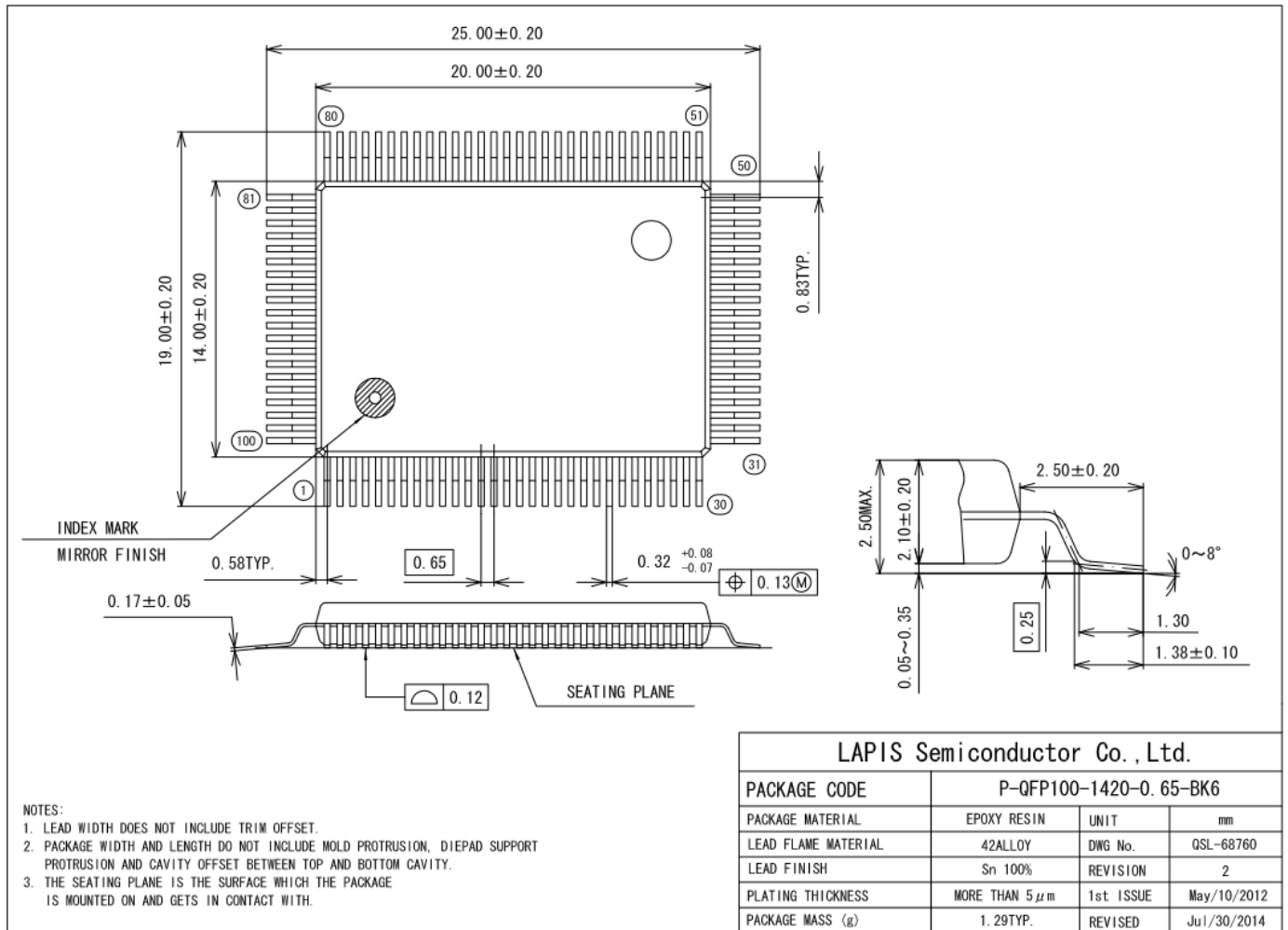

(Unit: mm)

Notes for Mounting the Surface Mount Type Package

The surface mount type packages are very susceptible to heat in reflow mounting and humidity absorbed in storage. Therefore, before you perform reflow mounting, contact a ROHM sales office for the product name, package name, pin number, package code and desired mounting conditions (reflow method, temperature and times).

REVISION HISTORY

Document No.	Date	Page		Description
		Previous Edition	Current Edition	
FEDL62Q1700-01	May 24, 2019	-	-	1 st Revision.

Notes

- 1) The information contained herein is subject to change without notice.
- 2) Although LAPIS Semiconductor is continuously working to improve product reliability and quality, semiconductors can break down and malfunction due to various factors. Therefore, in order to prevent personal injury or fire arising from failure, please take safety measures such as complying with the derating characteristics, implementing redundant and fire prevention designs, and utilizing backups and fail-safe procedures. LAPIS Semiconductor shall have no responsibility for any damages arising out of the use of our Products beyond the rating specified by LAPIS Semiconductor.
- 3) Examples of application circuits, circuit constants and any other information contained herein are provided only to illustrate the standard usage and operations of the Products. The peripheral conditions must be taken into account when designing circuits for mass production.
- 4) The technical information specified herein is intended only to show the typical functions of the Products and examples of application circuits for the Products. No license, expressly or implied, is granted hereby under any intellectual property rights or other rights of LAPIS Semiconductor or any third party with respect to the information contained in this document; therefore LAPIS Semiconductor shall have no responsibility whatsoever for any dispute, concerning such rights owned by third parties, arising out of the use of such technical information.
- 5) The Products are intended for use in general electronic equipment (i.e. AV/OA devices, communication, consumer systems, gaming/entertainment sets) as well as the applications indicated in this document.
- 6) The Products specified in this document are not designed to be radiation tolerant.
- 7) For use of our Products in applications requiring a high degree of reliability (as exemplified below), please contact and consult with a LAPIS Semiconductor representative: transportation equipment (i.e. cars, ships, trains), primary communication equipment, traffic lights, fire/crime prevention, safety equipment, medical systems, servers, solar cells, and power transmission systems.
- 8) Do not use our Products in applications requiring extremely high reliability, such as aerospace equipment, nuclear power control systems, and submarine repeaters.
- 9) LAPIS Semiconductor shall have no responsibility for any damages or injury arising from non-compliance with the recommended usage conditions and specifications contained herein.
- 10) LAPIS Semiconductor has used reasonable care to ensure the accuracy of the information contained in this document. However, LAPIS Semiconductor does not warrant that such information is error-free and LAPIS Semiconductor shall have no responsibility for any damages arising from any inaccuracy or misprint of such information.
- 11) Please use the Products in accordance with any applicable environmental laws and regulations, such as the RoHS Directive. For more details, including RoHS compatibility, please contact a ROHM sales office. LAPIS Semiconductor shall have no responsibility for any damages or losses resulting non-compliance with any applicable laws or regulations.
- 12) When providing our Products and technologies contained in this document to other countries, you must abide by the procedures and provisions stipulated in all applicable export laws and regulations, including without limitation the US Export Administration Regulations and the Foreign Exchange and Foreign Trade Act.
- 13) This document, in part or in whole, may not be reprinted or reproduced without prior consent of LAPIS Semiconductor.

Copyright 2019 LAPIS Semiconductor Co., Ltd.

LAPIS Semiconductor Co.,Ltd.

2-4-8 Shinyokohama, Kouhoku-ku,
Yokohama 222-8575, Japan
<http://www.lapis-semi.com/en/>