

To our customers,

---

## Old Company Name in Catalogs and Other Documents

---

On April 1<sup>st</sup>, 2010, NEC Electronics Corporation merged with Renesas Technology Corporation, and Renesas Electronics Corporation took over all the business of both companies. Therefore, although the old company name remains in this document, it is a valid Renesas Electronics document. We appreciate your understanding.

Renesas Electronics website: <http://www.renesas.com>

April 1<sup>st</sup>, 2010  
Renesas Electronics Corporation

Issued by: Renesas Electronics Corporation (<http://www.renesas.com>)

Send any inquiries to <http://www.renesas.com/inquiry>.

## Notice

1. All information included in this document is current as of the date this document is issued. Such information, however, is subject to change without any prior notice. Before purchasing or using any Renesas Electronics products listed herein, please confirm the latest product information with a Renesas Electronics sales office. Also, please pay regular and careful attention to additional and different information to be disclosed by Renesas Electronics such as that disclosed through our website.
2. Renesas Electronics does not assume any liability for infringement of patents, copyrights, or other intellectual property rights of third parties by or arising from the use of Renesas Electronics products or technical information described in this document. No license, express, implied or otherwise, is granted hereby under any patents, copyrights or other intellectual property rights of Renesas Electronics or others.
3. You should not alter, modify, copy, or otherwise misappropriate any Renesas Electronics product, whether in whole or in part.
4. Descriptions of circuits, software and other related information in this document are provided only to illustrate the operation of semiconductor products and application examples. You are fully responsible for the incorporation of these circuits, software, and information in the design of your equipment. Renesas Electronics assumes no responsibility for any losses incurred by you or third parties arising from the use of these circuits, software, or information.
5. When exporting the products or technology described in this document, you should comply with the applicable export control laws and regulations and follow the procedures required by such laws and regulations. You should not use Renesas Electronics products or the technology described in this document for any purpose relating to military applications or use by the military, including but not limited to the development of weapons of mass destruction. Renesas Electronics products and technology may not be used for or incorporated into any products or systems whose manufacture, use, or sale is prohibited under any applicable domestic or foreign laws or regulations.
6. Renesas Electronics has used reasonable care in preparing the information included in this document, but Renesas Electronics does not warrant that such information is error free. Renesas Electronics assumes no liability whatsoever for any damages incurred by you resulting from errors in or omissions from the information included herein.
7. Renesas Electronics products are classified according to the following three quality grades: “Standard”, “High Quality”, and “Specific”. The recommended applications for each Renesas Electronics product depends on the product’s quality grade, as indicated below. You must check the quality grade of each Renesas Electronics product before using it in a particular application. You may not use any Renesas Electronics product for any application categorized as “Specific” without the prior written consent of Renesas Electronics. Further, you may not use any Renesas Electronics product for any application for which it is not intended without the prior written consent of Renesas Electronics. Renesas Electronics shall not be in any way liable for any damages or losses incurred by you or third parties arising from the use of any Renesas Electronics product for an application categorized as “Specific” or for which the product is not intended where you have failed to obtain the prior written consent of Renesas Electronics. The quality grade of each Renesas Electronics product is “Standard” unless otherwise expressly specified in a Renesas Electronics data sheets or data books, etc.
  - “Standard”: Computers; office equipment; communications equipment; test and measurement equipment; audio and visual equipment; home electronic appliances; machine tools; personal electronic equipment; and industrial robots.
  - “High Quality”: Transportation equipment (automobiles, trains, ships, etc.); traffic control systems; anti-disaster systems; anti-crime systems; safety equipment; and medical equipment not specifically designed for life support.
  - “Specific”: Aircraft; aerospace equipment; submersible repeaters; nuclear reactor control systems; medical equipment or systems for life support (e.g. artificial life support devices or systems), surgical implantations, or healthcare intervention (e.g. excision, etc.), and any other applications or purposes that pose a direct threat to human life.
8. You should use the Renesas Electronics products described in this document within the range specified by Renesas Electronics, especially with respect to the maximum rating, operating supply voltage range, movement power voltage range, heat radiation characteristics, installation and other product characteristics. Renesas Electronics shall have no liability for malfunctions or damages arising out of the use of Renesas Electronics products beyond such specified ranges.
9. Although Renesas Electronics endeavors to improve the quality and reliability of its products, semiconductor products have specific characteristics such as the occurrence of failure at a certain rate and malfunctions under certain use conditions. Further, Renesas Electronics products are not subject to radiation resistance design. Please be sure to implement safety measures to guard them against the possibility of physical injury, and injury or damage caused by fire in the event of the failure of a Renesas Electronics product, such as safety design for hardware and software including but not limited to redundancy, fire control and malfunction prevention, appropriate treatment for aging degradation or any other appropriate measures. Because the evaluation of microcomputer software alone is very difficult, please evaluate the safety of the final products or system manufactured by you.
10. Please contact a Renesas Electronics sales office for details as to environmental matters such as the environmental compatibility of each Renesas Electronics product. Please use Renesas Electronics products in compliance with all applicable laws and regulations that regulate the inclusion or use of controlled substances, including without limitation, the EU RoHS Directive. Renesas Electronics assumes no liability for damages or losses occurring as a result of your noncompliance with applicable laws and regulations.
11. This document may not be reproduced or duplicated, in any form, in whole or in part, without prior written consent of Renesas Electronics.
12. Please contact a Renesas Electronics sales office if you have any questions regarding the information contained in this document or Renesas Electronics products, or if you have any other inquiries.

(Note 1) “Renesas Electronics” as used in this document means Renesas Electronics Corporation and also includes its majority-owned subsidiaries.

(Note 2) “Renesas Electronics product(s)” means any product developed or manufactured by or for Renesas Electronics.

## 1. Overview

These MCUs are fabricated using a high-performance silicon gate CMOS process, embedding the R8C CPU core, and are packaged in a 32-pin molded-plastic LQFP. It implements sophisticated instructions for a high level of instruction efficiency. With 1 Mbyte of address space, they are capable of executing instructions at high speed.

Furthermore, the R8C/27 Group has on-chip data flash (1 KB × 2 blocks).

The difference between the R8C/26 Group and R8C/27 Group is only the presence or absence of data flash.

Their peripheral functions are the same.

### 1.1 Applications

Electronic household appliances, office equipment, audio equipment, consumer products, automotive, etc.

## 1.2 Performance Overview

Table 1.1 outlines the Functions and Specifications for R8C/26 Group and Table 1.2 outlines the Functions and Specifications for R8C/27 Group.

**Table 1.1 Functions and Specifications for R8C/26 Group**

	Item	Specification
CPU	Number of fundamental instructions	89 instructions
	Minimum instruction execution time	50 ns (f(XIN) = 20 MHz, VCC = 3.0 to 5.5 V) (other than K version) 62.5 ns (f(XIN) = 16 MHz, VCC = 3.0 to 5.5 V) (K version) 100 ns (f(XIN) = 10 MHz, VCC = 2.7 to 5.5 V) 200 ns (f(XIN) = 5 MHz, VCC = 2.2 to 5.5 V) (N, D version)
	Operating mode	Single-chip
	Address space	1 Mbyte
	Memory capacity	Refer to <b>Table 1.3 Product Information for R8C/26 Group</b>
Peripheral Functions	Ports	I/O ports: 25 pins, Input port: 3 pins
	LED drive ports	I/O ports: 8 pins (N, D version)
	Timers	Timer RA: 8 bits × 1 channel Timer RB: 8 bits × 1 channel (Each timer equipped with 8-bit prescaler) Timer RC: 16 bits × 1 channel (Input capture and output compare circuits) Timer RE: With real-time clock and compare match function (For J, K version, compare match function only.)
	Serial interfaces	2 channels (UART0, UART1) Clock synchronous serial I/O, UART
	Clock synchronous serial interface	1 channel I <sup>2</sup> C bus Interface <sup>(1)</sup> Clock synchronous serial I/O with chip select
	LIN module	Hardware LIN: 1 channel (timer RA, UART0)
	A/D converter	10-bit A/D converter: 1 circuit, 12 channels
	Watchdog timer	15 bits × 1 channel (with prescaler) Start-on-reset selectable
	Interrupts	Internal: 15 sources, External: 4 sources, Software: 4 sources, Priority levels: 7 levels
	Clock generation circuits	3 circuits <ul style="list-style-type: none"> <li>• XIN clock generation circuit (with on-chip feedback resistor)</li> <li>• On-chip oscillator (high speed, low speed) High-speed on-chip oscillator has a frequency adjustment function</li> <li>• XCIN clock generation circuit (32 kHz) (N, D version)</li> <li>• Real-time clock (timer RE) (N, D version)</li> </ul>
	Oscillation-stopped detector	XIN clock oscillation stop detection function
	Voltage detection circuit	On-chip
	Power-on reset circuit	On-chip
Electrical Characteristics	Supply voltage	VCC = 3.0 to 5.5 V (f(XIN) = 20 MHz) (other than K version) VCC = 3.0 to 5.5 V (f(XIN) = 16 MHz) (K version) VCC = 2.7 to 5.5 V (f(XIN) = 10 MHz) VCC = 2.2 to 5.5 V (f(XIN) = 5 MHz) (N, D version)
	Current consumption (N, D version)	Typ. 10 mA (VCC = 5.0 V, f(XIN) = 20 MHz) Typ. 6 mA (VCC = 3.0 V, f(XIN) = 10 MHz) Typ. 2.0 μA (VCC = 3.0 V, wait mode (f(XCIN) = 32 kHz)) Typ. 0.7 μA (VCC = 3.0 V, stop mode)
Flash Memory	Programming and erasure voltage	VCC = 2.7 to 5.5 V
	Programming and erasure endurance	100 times
Operating Ambient Temperature		-20 to 85°C (N version)
		-40 to 85°C (D, J version) <sup>(2)</sup> , -40 to 125°C (K version) <sup>(2)</sup>
Package		32-pin molded-plastic LQFP

NOTES:

1. I<sup>2</sup>C bus is a trademark of Koninklijke Philips Electronics N. V.
2. Specify the D, K version if D, K version functions are to be used.

**Table 1.2 Functions and Specifications for R8C/27 Group**

	Item	Specification
CPU	Number of fundamental instructions	89 instructions
	Minimum instruction execution time	50 ns (f(XIN) = 20 MHz, VCC = 3.0 to 5.5 V) (other than K version) 62.5 ns (f(XIN) = 16 MHz, VCC = 3.0 to 5.5 V) (K version) 100 ns (f(XIN) = 10 MHz, VCC = 2.7 to 5.5 V) 200 ns (f(XIN) = 5 MHz, VCC = 2.2 to 5.5 V) (N, D version)
	Operating mode	Single-chip
	Address space	1 Mbyte
	Memory capacity	Refer to <b>Table 1.4 Product Information of R8C/27 Group</b>
Peripheral Functions	Ports	I/O ports: 25 pins, Input port: 3 pins
	LED drive ports	I/O ports: 8 pins (N, D version)
	Timers	Timer RA: 8 bits × 1 channel Timer RB: 8 bits × 1 channel (Each timer equipped with 8-bit prescaler) Timer RC: 16 bits × 1 channel (Input capture and output compare circuits) Timer RE: With real-time clock and compare match function (For J, K version, compare match function only.)
	Serial interfaces	2 channels (UART0, UART1) Clock synchronous serial I/O, UART
	Clock synchronous serial interface	1 channel I <sup>2</sup> C bus Interface <sup>(1)</sup> Clock synchronous serial I/O with chip select
	LIN module	Hardware LIN: 1 channel (timer RA, UART0)
	A/D converter	10-bit A/D converter: 1 circuit, 12 channels
	Watchdog timer	15 bits × 1 channel (with prescaler) Start-on-reset selectable
	Interrupts	Internal: 15 sources, External: 4 sources, Software: 4 sources, Priority levels: 7 levels
	Clock generation circuits	3 circuits <ul style="list-style-type: none"> <li>XIN clock generation circuit (with on-chip feedback resistor)</li> <li>On-chip oscillator (high speed, low speed) High-speed on-chip oscillator has a frequency adjustment function</li> <li>XCIN clock generation circuit (32 kHz) (N, D version)</li> <li>Real-time clock (timer RE) (N, D version)</li> </ul>
	Oscillation-stopped detector	XIN clock oscillation stop detection function
	Voltage detection circuit	On-chip
	Power-on reset circuit	On-chip
	Electrical Characteristics	Supply voltage
Current consumption (N, D version)		Typ. 10 mA (VCC = 5.0 V, f(XIN) = 20 MHz) Typ. 6 mA (VCC = 3.0 V, f(XIN) = 10 MHz) Typ. 2.0 μA (VCC = 3.0 V, wait mode (f(XCIN) = 32 kHz)) Typ. 0.7 μA (VCC = 3.0 V, stop mode)
Flash Memory	Programming and erasure voltage	VCC = 2.7 to 5.5 V
	Programming and erasure endurance	10,000 times (data flash) 1,000 times (program ROM)
Operating Ambient Temperature		-20 to 85°C (N version) -40 to 85°C (D, J version) <sup>(2)</sup> , -40 to 125°C (K version) <sup>(2)</sup>
	Package	32-pin molded-plastic LQFP

## NOTES:

- I<sup>2</sup>C bus is a trademark of Koninklijke Philips Electronics N. V.
- Specify the D, K version if D, K version functions are to be used.

### 1.3 Block Diagram

Figure 1.1 shows a Block Diagram.

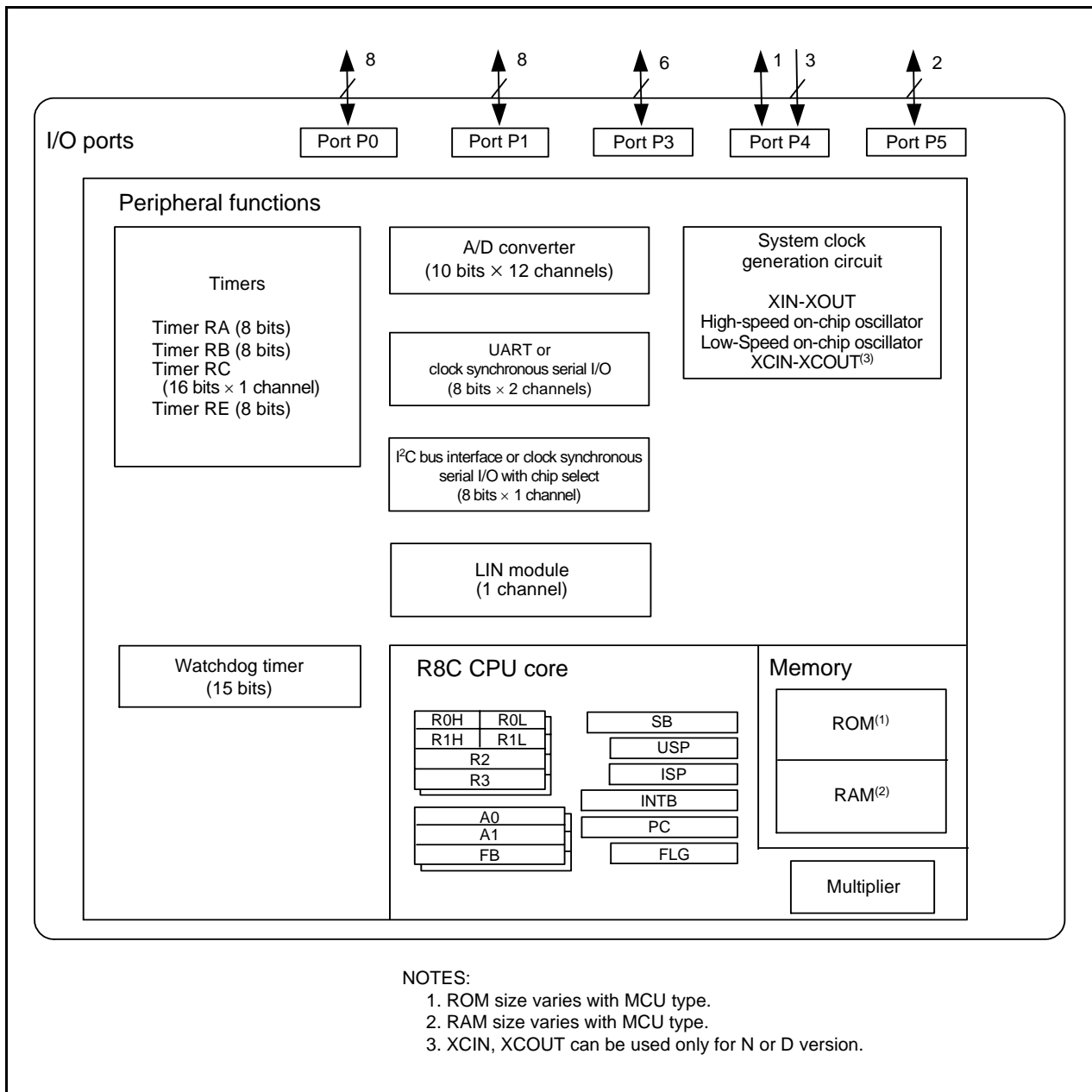

Figure 1.1 Block Diagram

## 1.4 Product Information

Table 1.3 lists the Product Information for R8C/26 Group and Table 1.4 lists the Product Information for R8C/27 Group.

**Table 1.3 Product Information for R8C/26 Group**

**Current of Sep. 2008**

Part No.	ROM Capacity	RAM Capacity	Package Type	Remarks	
R5F21262SNFP	8 Kbytes	512 bytes	PLQP0032GB-A	N version	
R5F21264SNFP	16 Kbytes	1 Kbyte	PLQP0032GB-A		
R5F21265SNFP	24 Kbytes	1.5 Kbytes	PLQP0032GB-A		
R5F21266SNFP	32 Kbytes	1.5 Kbytes	PLQP0032GB-A		
R5F21262SDFP	8 Kbytes	512 bytes	PLQP0032GB-A	D version	
R5F21264SDFP	16 Kbytes	1 Kbyte	PLQP0032GB-A		
R5F21265SDFP	24 Kbytes	1.5 Kbytes	PLQP0032GB-A		
R5F21266SDFP	32 Kbytes	1.5 Kbytes	PLQP0032GB-A		
R5F21264JFP	16 Kbytes	1 Kbyte	PLQP0032GB-A	J version	
R5F21266JFP	32 Kbytes	1.5 Kbytes	PLQP0032GB-A		
R5F21264KFP	16 Kbytes	1 Kbyte	PLQP0032GB-A	K version	
R5F21266KFP	32 Kbytes	1.5 Kbytes	PLQP0032GB-A		
R5F21262SNXXXFP	8 Kbytes	512 bytes	PLQP0032GB-A	N version	Factory programming product <sup>(1)</sup>
R5F21264SNXXXFP	16 Kbytes	1 Kbyte	PLQP0032GB-A		
R5F21265SNXXXFP	24 Kbytes	1.5 Kbytes	PLQP0032GB-A		
R5F21266SNXXXFP	32 Kbytes	1.5 Kbytes	PLQP0032GB-A		
R5F21262SDXXXFP	8 Kbytes	512 bytes	PLQP0032GB-A	D version	
R5F21264SDXXXFP	16 Kbytes	1 Kbyte	PLQP0032GB-A		
R5F21265SDXXXFP	24 Kbytes	1.5 Kbytes	PLQP0032GB-A		
R5F21266SDXXXFP	32 Kbytes	1.5 Kbytes	PLQP0032GB-A		
R5F21264JXXXFP	16 Kbytes	1 Kbyte	PLQP0032GB-A	J version	
R5F21266JXXXFP	32 Kbytes	1.5 Kbytes	PLQP0032GB-A		
R5F21264KXXXFP	16 Kbytes	1 Kbyte	PLQP0032GB-A	K version	
R5F21266KXXXFP	32 Kbytes	1.5 Kbytes	PLQP0032GB-A		

NOTE:

1. The user ROM is programmed before shipment.

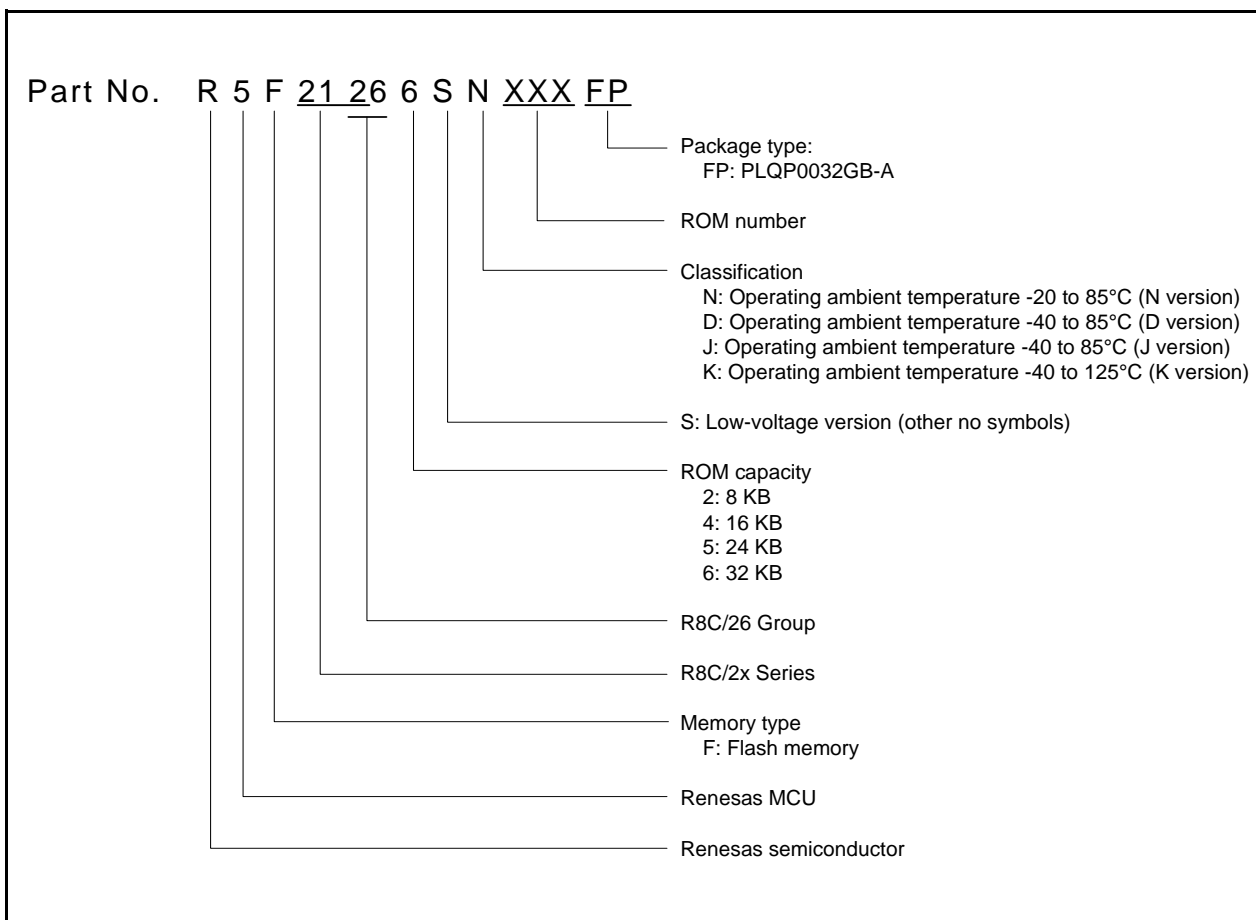

**Figure 1.2 Part Number, Memory Size, and Package of R8C/26 Group**



Table 1.4 Product Information for R8C/27 Group

Current of Sep. 2008

Part No.	ROM Capacity		RAM Capacity	Package Type	Remarks		
	Program ROM	Data flash					
R5F21272SNFP	8 Kbytes	1 Kbyte × 2	512 bytes	PLQP0032GB-A	N version		
R5F21274SNFP	16 Kbytes	1 Kbyte × 2	1 Kbyte	PLQP0032GB-A			
R5F21275SNFP	24 Kbytes	1 Kbyte × 2	1.5 Kbytes	PLQP0032GB-A			
R5F21276SNFP	32 Kbytes	1 Kbyte × 2	1.5 Kbytes	PLQP0032GB-A			
R5F21272SDFP	8 Kbytes	1 Kbyte × 2	512 bytes	PLQP0032GB-A	D version		
R5F21274SDFP	16 Kbytes	1 Kbyte × 2	1 Kbyte	PLQP0032GB-A			
R5F21275SDFP	24 Kbytes	1 Kbyte × 2	1.5 Kbytes	PLQP0032GB-A			
R5F21276SDFP	32 Kbytes	1 Kbyte × 2	1.5 Kbytes	PLQP0032GB-A			
R5F21274JFP	16 Kbytes	1 Kbyte × 2	1 Kbyte	PLQP0032GB-A	J version		
R5F21276JFP	32 Kbytes	1 Kbyte × 2	1.5 Kbytes	PLQP0032GB-A			
R5F21274KFP	16 Kbytes	1 Kbyte × 2	1 Kbyte	PLQP0032GB-A	K version		
R5F21276KFP	32 Kbytes	1 Kbyte × 2	1.5 Kbytes	PLQP0032GB-A			
R5F21272SNXXXFP	8 Kbytes	1 Kbyte × 2	512 bytes	PLQP0032GB-A	N version	Factory programming product <sup>(1)</sup>	
R5F21274SNXXXFP	16 Kbytes	1 Kbyte × 2	1 Kbyte	PLQP0032GB-A			
R5F21275SNXXXFP	24 Kbytes	1 Kbyte × 2	1.5 Kbytes	PLQP0032GB-A			
R5F21276SNXXXFP	32 Kbytes	1 Kbyte × 2	1.5 Kbytes	PLQP0032GB-A			
R5F21272SDXXXFP	8 Kbytes	1 Kbyte × 2	512 bytes	PLQP0032GB-A	D version		
R5F21274SDXXXFP	16 Kbytes	1 Kbyte × 2	1 Kbyte	PLQP0032GB-A			
R5F21275SDXXXFP	24 Kbytes	1 Kbyte × 2	1.5 Kbytes	PLQP0032GB-A			
R5F21276SDXXXFP	32 Kbytes	1 Kbyte × 2	1.5 Kbytes	PLQP0032GB-A			
R5F21274JXXXFP	16 Kbytes	1 Kbyte × 2	1 Kbyte	PLQP0032GB-A	J version		
R5F21276JXXXFP	32 Kbytes	1 Kbyte × 2	1.5 Kbytes	PLQP0032GB-A			
R5F21274KXXXFP	16 Kbytes	1 Kbyte × 2	1 Kbyte	PLQP0032GB-A	K version		
R5F21276KXXXFP	32 Kbytes	1 Kbyte × 2	1.5 Kbytes	PLQP0032GB-A			

## NOTE:

1. The user ROM is programmed before shipment.

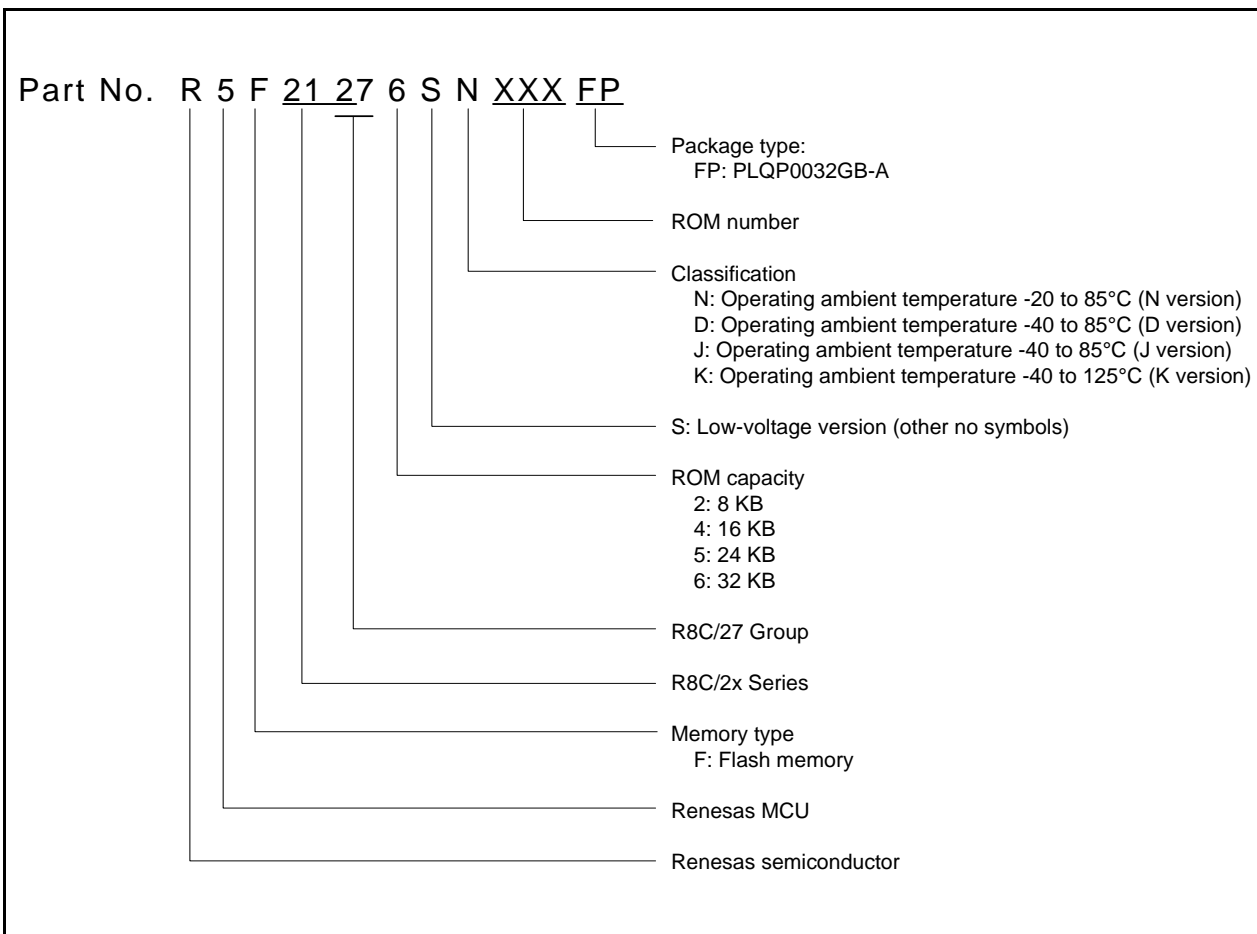

Figure 1.3 Part Number, Memory Size, and Package of R8C/27 Group

### 1.5 Pin Assignments

Figure 1.4 shows Pin Assignments (Top View).

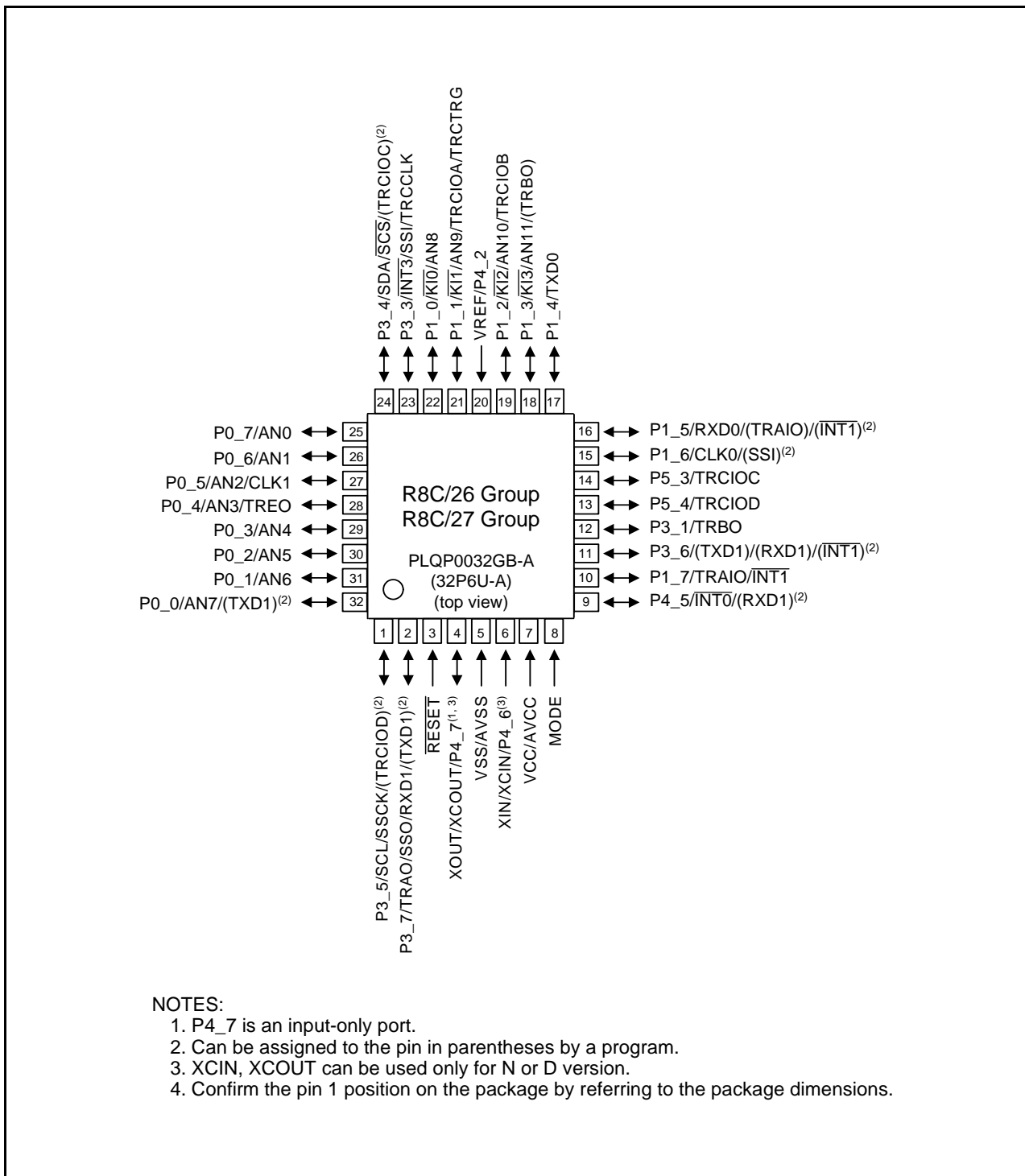

Figure 1.4 Pin Assignments (Top View)

## 1.6 Pin Functions

Table 1.5 lists Pin Functions.

**Table 1.5 Pin Functions**

Type	Symbol	I/O Type	Description
Power supply input	VCC, VSS	I	Apply 2.2 to 5.5 V (J, K version are 2.7 to 5.5 V) to the VCC pin. Apply 0 V to the VSS pin.
Analog power supply input	AVCC, AVSS	I	Power supply for the A/D converter. Connect a capacitor between AVCC and AVSS.
Reset input	$\overline{\text{RESET}}$	I	Input "L" on this pin resets the MCU.
MODE	MODE	I	Connect this pin to VCC via a resistor.
XIN clock input	XIN	I	These pins are provided for XIN clock generation circuit I/O. Connect a ceramic resonator or a crystal oscillator between the XIN and XOUT pins. To use an external clock, input it to the XIN pin and leave the XOUT pin open.
XIN clock output	XOUT	O	
XCIN clock input (N, D version)	XCIN	I	These pins are provided for XCIN clock generation circuit I/O. Connect a crystal oscillator between the XCIN and XCOU pins. To use an external clock, input it to the XCIN pin and leave the XCOU pin open.
XCIN clock output (N, D version)	XCOU	O	
$\overline{\text{INT}}$ interrupt input	$\overline{\text{INT0}}, \overline{\text{INT1}}, \overline{\text{INT3}}$	I	$\overline{\text{INT}}$ interrupt input pins
Key input interrupt	$\overline{\text{KI0}}$ to $\overline{\text{KI3}}$	I	Key input interrupt input pins
Timer RA	TRA0	O	Timer RA output pin
	TRAIO	I/O	Timer RA I/O pin
Timer RB	TRBO	O	Timer RB output pin
Timer RC	TRCLK	I	External clock input pin
	TRCTR	I	External trigger input pin
	TRCIOA, TRCIOB, TRCIO, TRCIOD	I/O	Sharing output-compare output / input-capture input / PWM / PWM2 output pins
Timer RE	TREO	O	Timer RE output pin
Serial interface	CLK0, CLK1	I/O	Clock I/O pin
	RXD0, RXD1	I	Receive data input pin
	TXD0, TXD1	O	Transmit data output pin
I <sup>2</sup> C bus interface	SCL	I/O	Clock I/O pin
	SDA	I/O	Data I/O pin
Clock synchronous serial I/O with chip select	SSI	I/O	Data I/O pin
	$\overline{\text{SCS}}$	I/O	Chip-select signal I/O pin
	SSCK	I/O	Clock I/O pin
	SSO	I/O	Data I/O pin
Reference voltage input	VREF	I	Reference voltage input pin to A/D converter
A/D converter	AN0 to AN11	I	Analog input pins to A/D converter
I/O port	P0_0 to P0_7, P1_0 to P1_7, P3_1, P3_3 to P3_7, P4_5, P5_3, P5_4	I/O	CMOS I/O ports. Each port has an I/O select direction register, allowing each pin in the port to be directed for input or output individually. Any port set to input can be set to use a pull-up resistor or not by a program. P1_0 to P1_7 also function as LED drive ports (N, D version).
Input port	P4_2, P4_6, P4_7	I	Input-only ports

I: Input      O: Output      I/O: Input and output

**Table 1.6 Pin Name Information by Pin Number**

Pin Number	Control Pin	Port	I/O Pin Functions for of Peripheral Modules					
			Interrupt	Timer	Serial Interface	Clock Synchronous Serial I/O with Chip Select	I <sup>2</sup> C bus Interface	A/D Converter
1		P3_5		(TRCIOD) <sup>(1)</sup>		SSCK	SCL	
2		P3_7		TRAO	RXD1/ (TXD1) <sup>(1, 3)</sup>	SSO		
3	RESET							
4	XOUT/XCOUT <sup>(2)</sup>	P4_7						
5	VSS/AVSS							
6	XIN/XCIN <sup>(2)</sup>	P4_6						
7	VCC/AVCC							
8	MODE							
9		P4_5	$\overline{\text{INT0}}$		(RXD1) <sup>(1, 3)</sup>			
10		P1_7	$\overline{\text{INT1}}$	TRAIO				
11		P3_6	$\overline{(\text{INT1})}^{(1)}$		(TXD1)/ (RXD1) <sup>(1, 3)</sup>			
12		P3_1		TRBO				
13		P5_4		TRCIOD				
14		P5_3		TRCIOC				
15		P1_6			CLK0	(SSI) <sup>(1)</sup>		
16		P1_5	$\overline{(\text{INT1})}^{(1)}$	(TRAIO) <sup>(1)</sup>	RXD0			
17		P1_4			TXD0			
18		P1_3	$\overline{\text{KI3}}$	(TRBO)				AN11
19		P1_2	$\overline{\text{KI2}}$	TRCIOB				AN10
20	VRFF	P4_2						
21		P1_1	$\overline{\text{KI1}}$	TRCIOA/ TRCTRG				AN9
22		P1_0	$\overline{\text{KI0}}$					AN8
23		P3_3	$\overline{\text{INT3}}$	TRCCLK		SSI		
24		P3_4		(TRCIOC) <sup>(1)</sup>		$\overline{\text{SCS}}$	SDA	
25		P0_7						AN0
26		P0_6						AN1
27		P0_5			CLK1			AN2
28		P0_4		TREO				AN3
29		P0_3						AN4
30		P0_2						AN5
31		P0_1						AN6
32		P0_0			(TXD1) <sup>(1, 3)</sup>			AN7

## NOTES:

1. This can be assigned to the pin in parentheses by a program.
2. XCIN, XCOU can be used only for N or D version.
3. For the combination of using pins TXD1 and RXD1, refer to **Figure 15.7 Registers PINSR1 and PMR** of Hardware Manual (REJ09B0278).

## 2. Central Processing Unit (CPU)

Figure 2.1 shows the CPU Registers. The CPU contains 13 registers. R0, R1, R2, R3, A0, A1, and FB configure a register bank. There are two sets of register bank.

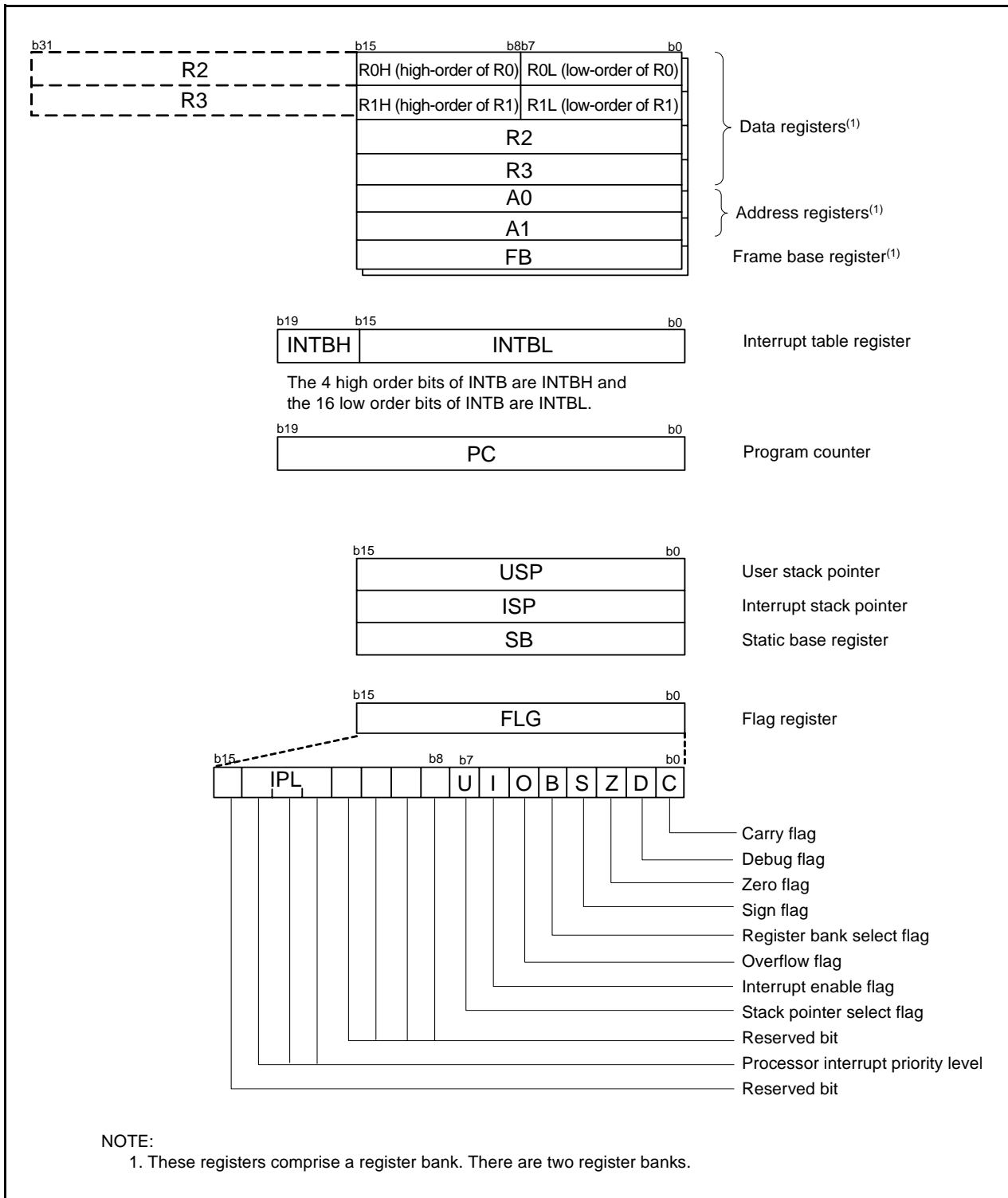

Figure 2.1 CPU Registers

## 2.1 Data Registers (R0, R1, R2, and R3)

R0 is a 16-bit register for transfer, arithmetic, and logic operations. The same applies to R1 to R3. R0 can be split into high-order bits (R0H) and low-order bits (R0L) to be used separately as 8-bit data registers. R1H and R1L are analogous to R0H and R0L. R2 can be combined with R0 and used as a 32-bit data register (R2R0). R3R1 is analogous to R2R0.

## 2.2 Address Registers (A0 and A1)

A0 is a 16-bit register for address register indirect addressing and address register relative addressing. It is also used for transfer, arithmetic, and logic operations. A1 is analogous to A0. A1 can be combined with A0 to be used as a 32-bit address register (A1A0).

## 2.3 Frame Base Register (FB)

FB is a 16-bit register for FB relative addressing.

## 2.4 Interrupt Table Register (INTB)

INTB is a 20-bit register that indicates the start address of an interrupt vector table.

## 2.5 Program Counter (PC)

PC is 20 bits wide and indicates the address of the next instruction to be executed.

## 2.6 User Stack Pointer (USP) and Interrupt Stack Pointer (ISP)

The stack pointers (SP), USP, and ISP, are each 16 bits wide. The U flag of FLG is used to switch between USP and ISP.

## 2.7 Static Base Register (SB)

SB is a 16-bit register for SB relative addressing.

## 2.8 Flag Register (FLG)

FLG is an 11-bit register indicating the CPU state.

### 2.8.1 Carry Flag (C)

The C flag retains carry, borrow, or shift-out bits that have been generated by the arithmetic and logic unit.

### 2.8.2 Debug Flag (D)

The D flag is for debugging only. Set it to 0.

### 2.8.3 Zero Flag (Z)

The Z flag is set to 1 when an arithmetic operation results in 0; otherwise to 0.

### 2.8.4 Sign Flag (S)

The S flag is set to 1 when an arithmetic operation results in a negative value; otherwise to 0.

### 2.8.5 Register Bank Select Flag (B)

Register bank 0 is selected when the B flag is 0. Register bank 1 is selected when this flag is set to 1.

### 2.8.6 Overflow Flag (O)

The O flag is set to 1 when an operation results in an overflow; otherwise to 0.

### **2.8.7 Interrupt Enable Flag (I)**

The I flag enables maskable interrupts.

Interrupt are disabled when the I flag is set to 0, and are enabled when the I flag is set to 1. The I flag is set to 0 when an interrupt request is acknowledged.

### **2.8.8 Stack Pointer Select Flag (U)**

ISP is selected when the U flag is set to 0; USP is selected when the U flag is set to 1.

The U flag is set to 0 when a hardware interrupt request is acknowledged or the INT instruction of software interrupt numbers 0 to 31 is executed.

### **2.8.9 Processor Interrupt Priority Level (IPL)**

IPL is 3 bits wide and assigns processor interrupt priority levels from level 0 to level 7.

If a requested interrupt has higher priority than IPL, the interrupt is enabled.

### **2.8.10 Reserved Bit**

If necessary, set to 0. When read, the content is undefined.



### 3. Memory

#### 3.1 R8C/26 Group

Figure 3.1 is a Memory Map of R8C/26 Group. The R8C/26 group has 1 Mbyte of address space from addresses 00000h to FFFFFh.

The internal ROM is allocated lower addresses, beginning with address 0FFFFh. For example, a 16-Kbyte internal ROM area is allocated addresses 0C000h to 0FFFFh.

The fixed interrupt vector table is allocated addresses 0FFDCh to 0FFFFh. They store the starting address of each interrupt routine.

The internal RAM is allocated higher addresses beginning with address 00400h. For example, a 1-Kbyte internal RAM area is allocated addresses 00400h to 007FFh. The internal RAM is used not only for storing data but also for calling subroutines and as stacks when interrupt requests are acknowledged.

Special function registers (SFRs) are allocated addresses 00000h to 002FFh. The peripheral function control registers are allocated here. All addresses within the SFR, which have nothing allocated are reserved for future use and cannot be accessed by users.

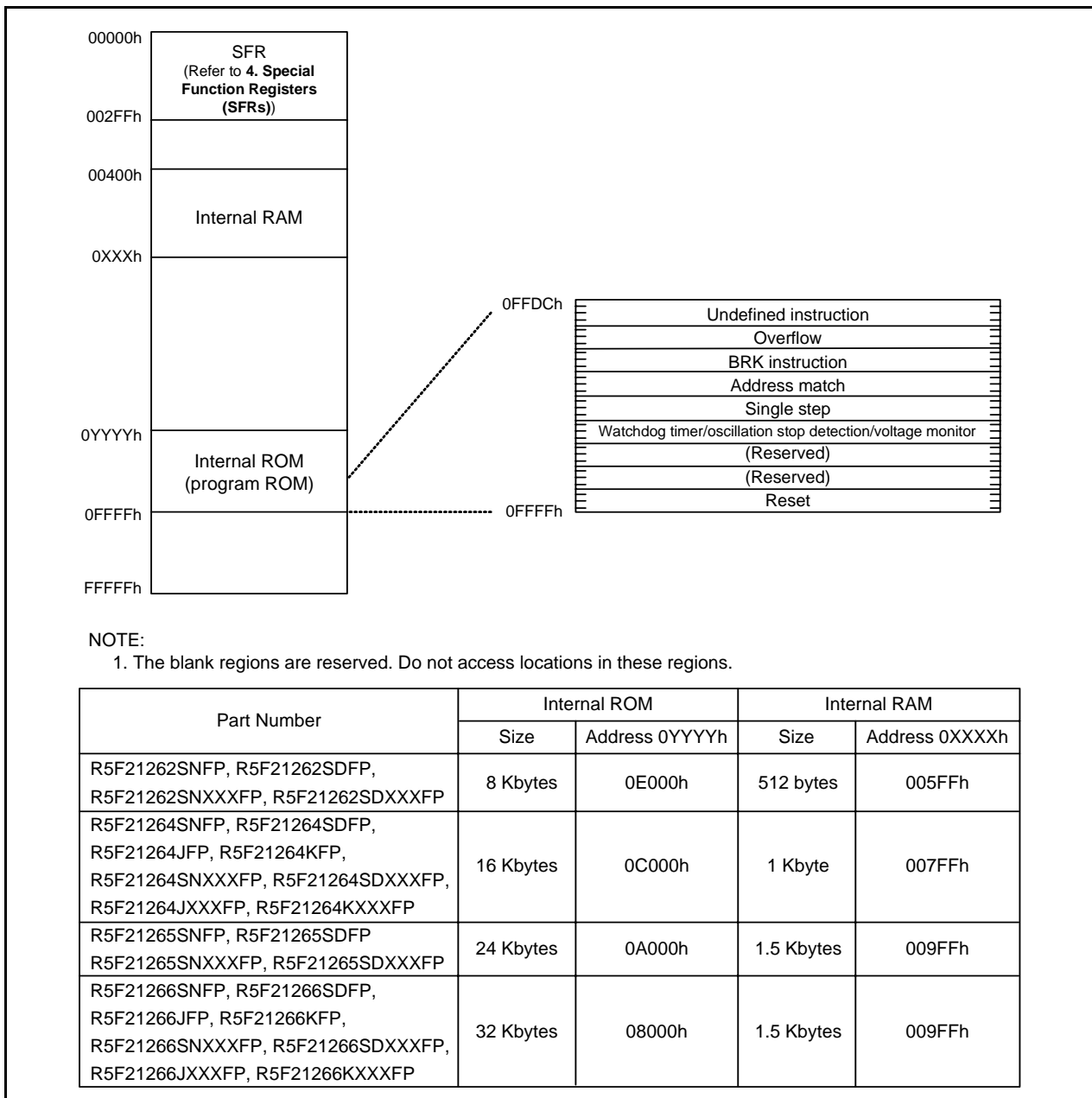

**Figure 3.1 Memory Map of R8C/26 Group**

### 3.2 R8C/27 Group

Figure 3.2 is a Memory Map of R8C/27 Group. The R8C/27 group has 1 Mbyte of address space from addresses 00000h to FFFFFh.

The internal ROM (program ROM) is allocated lower addresses, beginning with address 0FFFFh. For example, a 16-Kbyte internal ROM area is allocated addresses 0C000h to 0FFFFh.

The fixed interrupt vector table is allocated addresses 0FFDCh to 0FFFFh. They store the starting address of each interrupt routine.

The internal ROM (data flash) is allocated addresses 02400h to 02BFFh.

The internal RAM area is allocated higher addresses, beginning with address 00400h. For example, a 1-Kbyte internal RAM is allocated addresses 00400h to 007FFh. The internal RAM is used not only for storing data but also for calling subroutines and as stacks when interrupt requests are acknowledged.

Special function registers (SFRs) are allocated addresses 00000h to 002FFh. The peripheral function control registers are allocated here. All addresses within the SFR, which have nothing allocated are reserved for future use and cannot be accessed by users.

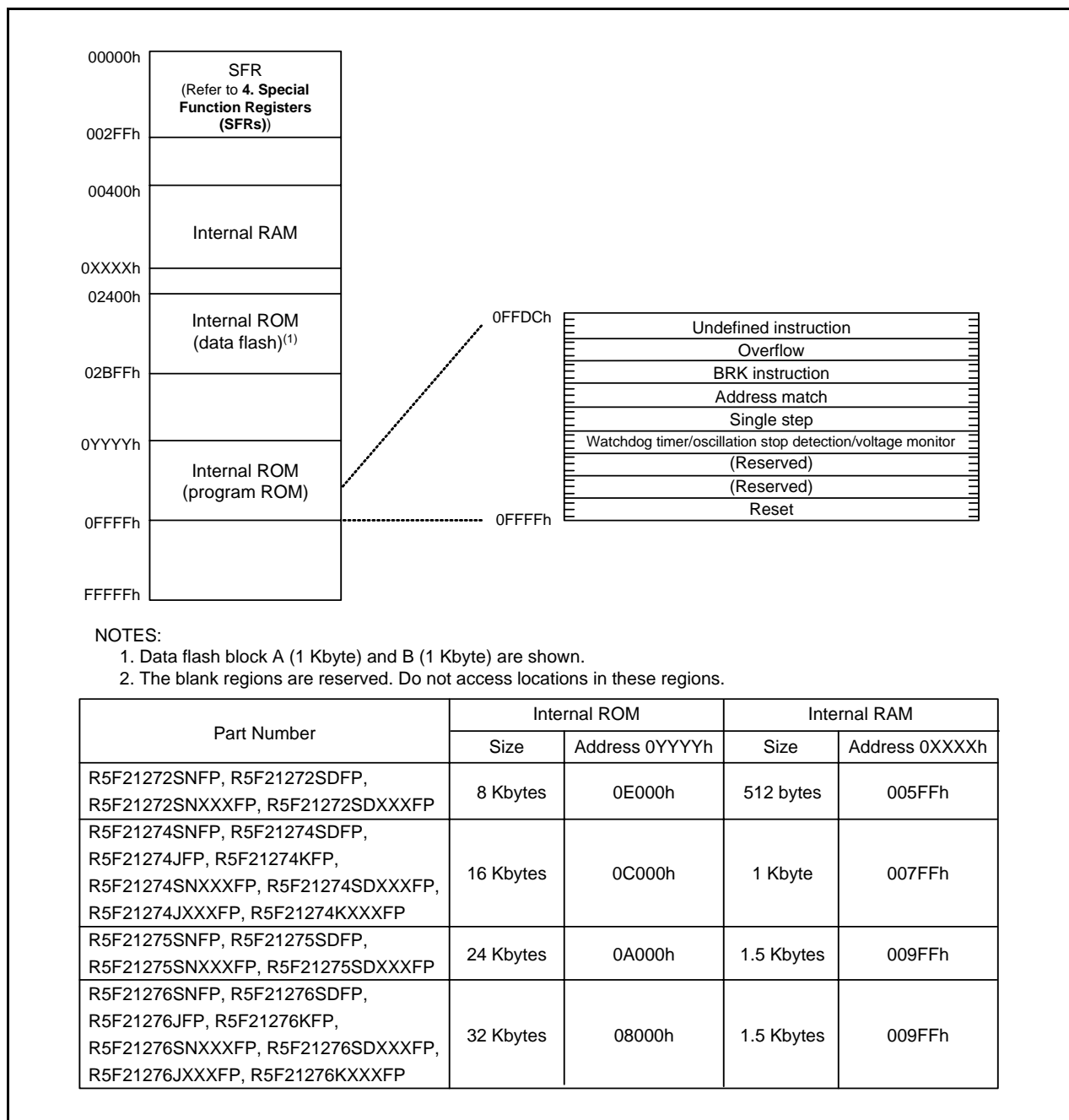

Figure 3.2 Memory Map of R8C/27 Group

## 4. Special Function Registers (SFRs)

An SFR (special function register) is a control register for a peripheral function. Tables 4.1 to 4.7 list the special function registers.

**Table 4.1 SFR Information (1)(1)**

Address	Register	Symbol	After reset
0000h			
0001h			
0002h			
0003h			
0004h	Processor Mode Register 0	PM0	00h
0005h	Processor Mode Register 1	PM1	00h
0006h	System Clock Control Register 0	CM0	01101000b
0007h	System Clock Control Register 1	CM1	00100000b
0008h			
0009h			
000Ah	Protect Register	PRCR	00h
000Bh			
000Ch	Oscillation Stop Detection Register	OCD	00000100b
000Dh	Watchdog Timer Reset Register	WDTR	XXh
000Eh	Watchdog Timer Start Register	WDTS	XXh
000Fh	Watchdog Timer Control Register	WDC	00X11111b
0010h	Address Match Interrupt Register 0	RMAD0	00h
0011h			00h
0012h			00h
0013h	Address Match Interrupt Enable Register	AIER	00h
0014h	Address Match Interrupt Register 1	RMAD1	00h
0015h			00h
0016h			00h
0017h			00h
0018h			
0019h			
001Ah			
001Bh			
001Ch	Count Source Protection Mode Register	CSPR	00h 10000000b <sup>(2)</sup>
001Dh			
001Eh			
001Fh			
0020h			
0021h			
0022h			
0023h	High-Speed On-Chip Oscillator Control Register 0	FRA0	00h
0024h	High-Speed On-Chip Oscillator Control Register 1	FRA1	When shipping
0025h	High-Speed On-Chip Oscillator Control Register 2	FRA2	00h
0026h			
0027h			
0028h	Clock Prescaler Reset Flag	CPSRF	00h
0029h	High-Speed On-Chip Oscillator Control Register 4 <sup>(3)</sup>	FRA4	When shipping
002Ah			
002Bh	High-Speed On-Chip Oscillator Control Register 6 <sup>(3)</sup>	FRA6	When shipping
002Ch	High-Speed On-Chip Oscillator Control Register 7 <sup>(3)</sup>	FRA7	When shipping
002Dh			
002Eh			
002Fh			

X: Undefined

NOTES:

1. The blank regions are reserved. Do not access locations in these regions.
2. The CSPROINI bit in the OFS register is set to 0.
3. In J, K version these regions are reserved. Do not access locations in these regions.

**Table 4.2 SFR Information (2)(1)**

Address	Register	Symbol	After reset
0030h			
0031h	Voltage Detection Register 1 (2)	VCA1	00001000b
0032h	Voltage Detection Register 2 (2)	VCA2	• N, D version 00h(3) 00100000b(4) • J, K version 00h(7) 01000000b(8)
0033h			
0034h			
0035h			
0036h	Voltage Monitor 1 Circuit Control Register (5)	VW1C	• N, D version 00001000b • J, K version 0000X000b(7) 0100X001b(8)
0037h	Voltage Monitor 2 Circuit Control Register (5)	VW2C	00h
0038h	Voltage Monitor 0 Circuit Control Register (6)	VW0C	0000X000b(3) 0100X001b(4)
0039h			
003Fh			
0040h			
0041h			
0042h			
0043h			
0044h			
0045h			
0046h			
0047h	Timer RC Interrupt Control Register	TRCIC	XXXXX000b
0048h			
0049h			
004Ah	Timer RE Interrupt Control Register	TREIC	XXXXX000b
004Bh			
004Ch			
004Dh	Key Input Interrupt Control Register	KUPIC	XXXXX000b
004Eh	A/D Conversion Interrupt Control Register	ADIC	XXXXX000b
004Fh	SSU/IIC bus Interrupt Control Register(9)	SSUIC/IICIC	XXXXX000b
0050h			
0051h	UART0 Transmit Interrupt Control Register	S0TIC	XXXXX000b
0052h	UART0 Receive Interrupt Control Register	S0RIC	XXXXX000b
0053h	UART1 Transmit Interrupt Control Register	S1TIC	XXXXX000b
0054h	UART1 Receive Interrupt Control Register	S1RIC	XXXXX000b
0055h			
0056h	Timer RA Interrupt Control Register	TRAIC	XXXXX000b
0057h			
0058h	Timer RB Interrupt Control Register	TRBIC	XXXXX000b
0059h	INT1 Interrupt Control Register	INT1IC	XX00X000b
005Ah	INT3 Interrupt Control Register	INT3IC	XX00X000b
005Bh			
005Ch			
005Dh	INT0 Interrupt Control Register	INT0IC	XX00X000b
005Eh			
005Fh			
0060h			
006Fh			
0070h			
007Fh			

X: Undefined

## NOTES:

- The blank regions are reserved. Do not access locations in these regions.
- (N, D version) Software reset, watchdog timer reset, voltage monitor 1 reset, or voltage monitor 2 reset do not affect this register.  
(J, K version) Software reset, watchdog timer reset, or voltage monitor 2 reset do not affect this register.
- The LVD0ON bit in the OFS register is set to 1 and hardware reset.
- Power-on reset, voltage monitor 0 reset or the LVD0ON bit in the OFS register is set to 0, and hardware reset.
- (N, D version) Software reset, watchdog timer reset, voltage monitor 1 reset, or voltage monitor 2 reset do not affect b2 and b3.  
(J, K version) Software reset, watchdog timer reset, or voltage monitor 2 reset do not affect b2 and b3.
- (N, D version) Software reset, watchdog timer reset, voltage monitor 1 reset, or voltage monitor 2 reset do not affect this register.  
(J, K version) These regions are reserved. Do not access locations in these regions.
- The LVD1ON bit in the OFS register is set to 1 and hardware reset.
- Power-on reset, voltage monitor 1 reset, or the LVD1ON bit in the OFS register is set to 0 and hardware reset.
- Selected by the IICSEL bit in the PMR register.

**Table 4.3 SFR Information (3)(1)**

Address	Register	Symbol	After reset
0080h			
0081h			
0082h			
0083h			
0084h			
0085h			
0086h			
0087h			
0088h			
0089h			
008Ah			
008Bh			
008Ch			
008Dh			
008Eh			
008Fh			
0090h			
0091h			
0092h			
0093h			
0094h			
0095h			
0096h			
0097h			
0098h			
0099h			
009Ah			
009Bh			
009Ch			
009Dh			
009Eh			
009Fh			
00A0h	UART0 Transmit/Receive Mode Register	U0MR	00h
00A1h	UART0 Bit Rate Register	U0BRG	XXh
00A2h	UART0 Transmit Buffer Register	U0TB	XXh
00A3h			XXh
00A4h	UART0 Transmit/Receive Control Register 0	U0C0	00001000b
00A5h	UART0 Transmit/Receive Control Register 1	U0C1	00000010b
00A6h	UART0 Receive Buffer Register	U0RB	XXh
00A7h			XXh
00A8h	UART1 Transmit/Receive Mode Register	U1MR	00h
00A9h	UART1 Bit Rate Register	U1BRG	XXh
00AAh	UART1 Transmit Buffer Register	U1TB	XXh
00ABh			XXh
00ACh	UART1 Transmit/Receive Control Register 0	U1C0	00001000b
00ADh	UART1 Transmit/Receive Control Register 1	U1C1	00000010b
00AEh	UART1 Receive Buffer Register	U1RB	XXh
00AFh			XXh
00B0h			
00B1h			
00B2h			
00B3h			
00B4h			
00B5h			
00B6h			
00B7h			
00B8h	SS Control Register H / IIC bus Control Register 1 <sup>(2)</sup>	SSCRH / ICCR1	00h
00B9h	SS Control Register L / IIC bus Control Register 2 <sup>(2)</sup>	SSCRL / ICCR2	01111101b
00BAh	SS Mode Register / IIC bus Mode Register <sup>(2)</sup>	SSMR / ICMR	00011000b
00BBh	SS Enable Register / IIC bus Interrupt Enable Register <sup>(2)</sup>	SSER / ICIER	00h
00BCh	SS Status Register / IIC bus Status Register <sup>(2)</sup>	SSSR / ICSR	00h / 0000X000b
00BDh	SS Mode Register 2 / Slave Address Register <sup>(2)</sup>	SSMR2 / SAR	00h
00BEh	SS Transmit Data Register / IIC bus Transmit Data Register <sup>(2)</sup>	SSTDR / ICDRT	FFh
00BFh	SS Receive Data Register / IIC bus Receive Data Register <sup>(2)</sup>	SSRDR / ICDDR	FFh

X: Undefined

## NOTES:

1. The blank regions are reserved. Do not access locations in these regions.
2. Selected by the IICSEL bit in the PMR register.

**Table 4.4 SFR Information (4)<sup>(1)</sup>**

Address	Register	Symbol	After reset
00C0h	A/D Register	AD	XXh
00C1h			XXh
00C2h			
00C3h			
00C4h			
00C5h			
00C6h			
00C7h			
00C8h			
00C9h			
00CAh			
00CBh			
00CCh			
00CDh			
00CEh			
00CFh			
00D0h			
00D1h			
00D2h			
00D3h			
00D4h	A/D Control Register 2	ADCON2	00h
00D5h			
00D6h	A/D Control Register 0	ADCON0	00h
00D7h	A/D Control Register 1	ADCON1	00h
00D8h			
00D9h			
00DAh			
00DBh			
00DCh			
00DDh			
00DEh			
00DFh			
00E0h	Port P0 Register	P0	00h
00E1h	Port P1 Register	P1	00h
00E2h	Port P0 Direction Register	PD0	00h
00E3h	Port P1 Direction Register	PD1	00h
00E4h			
00E5h	Port P3 Register	P3	00h
00E6h			
00E7h	Port P3 Direction Register	PD3	00h
00E8h	Port P4 Register	P4	00h
00E9h	Port P5 Register	P5	00h
00EAh	Port P4 Direction Register	PD4	00h
00EBh	Port P5 Direction Register	PD5	00h
00ECh			
00EDh			
00EEh			
00EFh			
00F0h			
00F1h			
00F2h			
00F3h			
00F4h			
00F5h	Pin Select Register 1	PINSR1	00h
00F6h	Pin Select Register 2	PINSR2	00h
00F7h	Pin Select Register 3	PINSR3	00h
00F8h	Port Mode Register	PMR	00h
00F9h	External Input Enable Register	INTEN	00h
00FAh	INT Input Filter Select Register	INTF	00h
00FBh	Key Input Enable Register	KIEN	00h
00FCh	Pull-Up Control Register 0	PUR0	00h
00FDh	Pull-Up Control Register 1	PUR1	00h
00FEh	Port P1 Drive Capacity Control Register <sup>(2)</sup>	P1DRR	00h
00FFh			

X: Undefined

NOTES:

1. The blank regions are reserved. Do not access locations in these regions.
2. In J, K version these regions are reserved. Do not access locations in these regions.

**Table 4.5 SFR Information (5)<sup>(1)</sup>**

Address	Register	Symbol	After reset
0100h	Timer RA Control Register	TRACR	00h
0101h	Timer RA I/O Control Register	TRAIOC	00h
0102h	Timer RA Mode Register	TRAMR	00h
0103h	Timer RA Prescaler Register	TRAPRE	FFh
0104h	Timer RA Register	TRA	FFh
0105h			
0106h	LIN Control Register	LINCR	00h
0107h	LIN Status Register	LINST	00h
0108h	Timer RB Control Register	TRBCR	00h
0109h	Timer RB One-Shot Control Register	TRBOCR	00h
010Ah	Timer RB I/O Control Register	TRBIOC	00h
010Bh	Timer RB Mode Register	TRBMR	00h
010Ch	Timer RB Prescaler Register	TRBPRES	FFh
010Dh	Timer RB Secondary Register	TRBSC	FFh
010Eh	Timer RB Primary Register	TRBPR	FFh
010Fh			
0110h			
0111h			
0112h			
0113h			
0114h			
0115h			
0116h			
0117h			
0118h	Timer RE Second Data Register / Counter Data Register	TRESEC	00h
0119h	Timer RE Minute Data Register / Compare Data Register	TREMIN	00h
011Ah	Timer RE Hour Data Register <sup>(2)</sup>	TREHR	00h
011Bh	Timer RE Day of Week Data Register <sup>(2)</sup>	TREWK	00h
011Ch	Timer RE Control Register 1	TRECR1	00h
011Dh	Timer RE Control Register 2	TRECR2	00h
011Eh	Timer RE Count Source Select Register	TRECSR	00001000b
011Fh			
0120h	Timer RC Mode Register	TRCMR	01001000b
0121h	Timer RC Control Register 1	TRCCR1	00h
0122h	Timer RC Interrupt Enable Register	TRCIER	01110000b
0123h	Timer RC Status Register	TRCSR	01110000b
0124h	Timer RC I/O Control Register 0	TRCIOR0	10001000b
0125h	Timer RC I/O Control Register 1	TRCIOR1	10001000b
0126h	Timer RC Counter	TRC	00h
0127h			00h
0128h	Timer RC General Register A	TRCGRA	FFh
0129h			FFh
012Ah	Timer RC General Register B	TRCGRB	FFh
012Bh			FFh
012Ch	Timer RC General Register C	TRCGRC	FFh
012Dh			FFh
012Eh	Timer RC General Register D	TRCGRD	FFh
012Fh			FFh
0130h	Timer RC Control Register 2	TRCCR2	00011111b
0131h	Timer RC Digital Filter Function Select Register	TRCDF	00h
0132h	Timer RC Output Master Enable Register	TRCOER	01111111b
0133h			
0134h			
0135h			
0136h			
0137h			
0138h			
0139h			
013Ah			
013Bh			
013Ch			
013Dh			
013Eh			
013Fh			

## NOTES:

1. The blank regions are reserved. Do not access locations in these regions.
2. In J, K version these regions are reserved. Do not access locations in these regions.

**Table 4.6 SFR Information (6)<sup>(1)</sup>**

Address	Register	Symbol	After reset
0140h			
0141h			
0142h			
0143h			
0144h			
0145h			
0146h			
0147h			
0148h			
0149h			
014Ah			
014Bh			
014Ch			
014Dh			
014Eh			
014Fh			
0150h			
0151h			
0152h			
0153h			
0154h			
0155h			
0156h			
0157h			
0158h			
0159h			
015Ah			
015Bh			
015Ch			
015Dh			
015Eh			
015Fh			
0160h			
0161h			
0162h			
0163h			
0164h			
0165h			
0166h			
0167h			
0168h			
0169h			
016Ah			
016Bh			
016Ch			
016Dh			
016Eh			
016Fh			
0170h			
0171h			
0172h			
0173h			
0174h			
0175h			
0176h			
0177h			
0178h			
0179h			
017Ah			
017Bh			
017Ch			
017Dh			
017Eh			
017Fh			

NOTE:

1. The blank regions are reserved. Do not access locations in these regions.



**Table 4.7 SFR Information (7)(1)**

Address	Register	Symbol	After reset
0180h			
0181h			
0182h			
0183h			
0184h			
0185h			
0186h			
0187h			
0188h			
0189h			
018Ah			
018Bh			
018Ch			
018Dh			
018Eh			
018Fh			
0190h			
0191h			
0192h			
0193h			
0194h			
0195h			
0196h			
0197h			
0198h			
0199h			
019Ah			
019Bh			
019Ch			
019Dh			
019Eh			
019Fh			
01A0h			
01A1h			
01A2h			
01A3h			
01A4h			
01A5h			
01A6h			
01A7h			
01A8h			
01A9h			
01AAh			
01ABh			
01ACh			
01ADh			
01AEh			
01AFh			
01B0h			
01B1h			
01B2h			
01B3h	Flash Memory Control Register 4	FMR4	01000000b
01B4h			
01B5h	Flash Memory Control Register 1	FMR1	1000000Xb
01B6h			
01B7h	Flash Memory Control Register 0	FMR0	00000001b
01B8h			
01B9h			
01BAh			
01BBh			
01BCh			
01BDh			
01BEh			
01BFh			

FFFFh	Option Function Select Register	OFS	(Note 2)
-------	---------------------------------	-----	----------

X: Undefined

NOTES:

1. The blank regions are reserved. Do not access locations in these regions.
2. The OFS register cannot be changed by a program. Use a flash programmer to write to it.

## 5. Electrical Characteristics

### 5.1 N, D Version

**Table 5.1 Absolute Maximum Ratings**

Symbol	Parameter	Condition	Rated Value	Unit
V <sub>CC</sub> /AV <sub>CC</sub>	Supply voltage		-0.3 to 6.5	V
V <sub>I</sub>	Input voltage		-0.3 to V <sub>CC</sub> + 0.3	V
V <sub>O</sub>	Output voltage		-0.3 to V <sub>CC</sub> + 0.3	V
P <sub>d</sub>	Power dissipation	T <sub>opr</sub> = 25°C	500	mW
T <sub>opr</sub>	Operating ambient temperature		-20 to 85 (N version) / -40 to 85 (D version)	°C
T <sub>stg</sub>	Storage temperature		-65 to 150	°C

**Table 5.2 Recommended Operating Conditions**

Symbol	Parameter		Conditions	Standard			Unit	
				Min.	Typ.	Max.		
V <sub>CC</sub> /AV <sub>CC</sub>	Supply voltage			2.2	–	5.5	V	
V <sub>SS</sub> /AV <sub>SS</sub>	Supply voltage			–	0	–	V	
V <sub>IH</sub>	Input “H” voltage			0.8 V <sub>CC</sub>	–	V <sub>CC</sub>	V	
V <sub>IL</sub>	Input “L” voltage			0	–	0.2 V <sub>CC</sub>	V	
I <sub>OH</sub> (sum)	Peak sum output “H” current	Sum of all pins I <sub>OH</sub> (peak)		–	–	-160	mA	
I <sub>OH</sub> (sum)	Average sum output “H” current	Sum of all pins I <sub>OH</sub> (avg)		–	–	-80	mA	
I <sub>OH</sub> (peak)	Peak output “H” current	Except P1_0 to P1_7		–	–	-10	mA	
		P1_0 to P1_7		–	–	-40	mA	
I <sub>OH</sub> (avg)	Average output “H” current	Except P1_0 to P1_7		–	–	-5	mA	
		P1_0 to P1_7		–	–	-20	mA	
I <sub>OL</sub> (sum)	Peak sum output “L” currents	Sum of all pins I <sub>OL</sub> (peak)		–	–	160	mA	
I <sub>OL</sub> (sum)	Average sum output “L” currents	Sum of all pins I <sub>OL</sub> (avg)		–	–	80	mA	
I <sub>OL</sub> (peak)	Peak output “L” currents	Except P1_0 to P1_7		–	–	10	mA	
		P1_0 to P1_7		–	–	40	mA	
I <sub>OL</sub> (avg)	Average output “L” current	Except P1_0 to P1_7		–	–	5	mA	
		P1_0 to P1_7		–	–	20	mA	
f(XIN)	XIN clock input oscillation frequency		3.0 V ≤ V <sub>CC</sub> ≤ 5.5 V	0	–	20	MHz	
			2.7 V ≤ V <sub>CC</sub> < 3.0 V	0	–	10	MHz	
			2.2 V ≤ V <sub>CC</sub> < 2.7 V	0	–	5	MHz	
f(XCIN)	XCIN clock input oscillation frequency		2.2 V ≤ V <sub>CC</sub> ≤ 5.5 V	0	–	70	kHz	
–	System clock	OCD2 = 0 XIN clock selected	3.0 V ≤ V <sub>CC</sub> ≤ 5.5 V	0	–	20	MHz	
			2.7 V ≤ V <sub>CC</sub> < 3.0 V	0	–	10	MHz	
			2.2 V ≤ V <sub>CC</sub> < 2.7 V	0	–	5	MHz	
		OCD2 = 1 On-chip oscillator clock selected	FRA01 = 0 Low-speed on-chip oscillator clock selected	–	125	–	–	kHz
			FRA01 = 1 High-speed on-chip oscillator clock selected 3.0 V ≤ V <sub>CC</sub> ≤ 5.5 V	–	–	–	20	MHz
			FRA01 = 1 High-speed on-chip oscillator clock selected 2.7 V ≤ V <sub>CC</sub> ≤ 5.5 V	–	–	–	10	MHz
FRA01 = 1 High-speed on-chip oscillator clock selected 2.2 V ≤ V <sub>CC</sub> ≤ 5.5 V	–	–	–	5	MHz			

**NOTES:**

- V<sub>CC</sub> = 2.2 to 5.5 V at T<sub>opr</sub> = -20 to 85°C (N version) / -40 to 85°C (D version), unless otherwise specified.
- The average output current indicates the average value of current measured during 100 ms.

**Table 5.3 A/D Converter Characteristics**

Symbol	Parameter		Conditions	Standard			Unit
				Min.	Typ.	Max.	
–	Resolution		$V_{ref} = AV_{CC}$	–	–	10	Bits
–	Absolute accuracy	10-bit mode	$\phi_{AD} = 10 \text{ MHz}, V_{ref} = AV_{CC} = 5.0 \text{ V}$	–	–	$\pm 3$	LSB
		8-bit mode	$\phi_{AD} = 10 \text{ MHz}, V_{ref} = AV_{CC} = 5.0 \text{ V}$	–	–	$\pm 2$	LSB
		10-bit mode	$\phi_{AD} = 10 \text{ MHz}, V_{ref} = AV_{CC} = 3.3 \text{ V}$	–	–	$\pm 5$	LSB
		8-bit mode	$\phi_{AD} = 10 \text{ MHz}, V_{ref} = AV_{CC} = 3.3 \text{ V}$	–	–	$\pm 2$	LSB
		10-bit mode	$\phi_{AD} = 5 \text{ MHz}, V_{ref} = AV_{CC} = 2.2 \text{ V}$	–	–	$\pm 5$	LSB
		8-bit mode	$\phi_{AD} = 5 \text{ MHz}, V_{ref} = AV_{CC} = 2.2 \text{ V}$	–	–	$\pm 2$	LSB
$R_{ladder}$	Resistor ladder		$V_{ref} = AV_{CC}$	10	–	40	$k\Omega$
$t_{conv}$	Conversion time	10-bit mode	$\phi_{AD} = 10 \text{ MHz}, V_{ref} = AV_{CC} = 5.0 \text{ V}$	3.3	–	–	$\mu\text{s}$
		8-bit mode	$\phi_{AD} = 10 \text{ MHz}, V_{ref} = AV_{CC} = 5.0 \text{ V}$	2.8	–	–	$\mu\text{s}$
$V_{ref}$	Reference voltage			2.2	–	$AV_{CC}$	V
$V_{IA}$	Analog input voltage <sup>(2)</sup>			0	–	$AV_{CC}$	V
–	A/D operating clock frequency	Without sample and hold	$V_{ref} = AV_{CC} = 2.7 \text{ to } 5.5 \text{ V}$	0.25	–	10	MHz
		With sample and hold	$V_{ref} = AV_{CC} = 2.7 \text{ to } 5.5 \text{ V}$	1	–	10	MHz
		Without sample and hold	$V_{ref} = AV_{CC} = 2.2 \text{ to } 5.5 \text{ V}$	0.25	–	5	MHz
		With sample and hold	$V_{ref} = AV_{CC} = 2.2 \text{ to } 5.5 \text{ V}$	1	–	5	MHz

NOTES:

1.  $AV_{CC} = 2.2 \text{ to } 5.5 \text{ V}$  at  $T_{opr} = -20 \text{ to } 85^\circ\text{C}$  (N version) /  $-40 \text{ to } 85^\circ\text{C}$  (D version), unless otherwise specified.
2. When the analog input voltage is over the reference voltage, the A/D conversion result will be 3FFh in 10-bit mode and FFh in 8-bit mode.

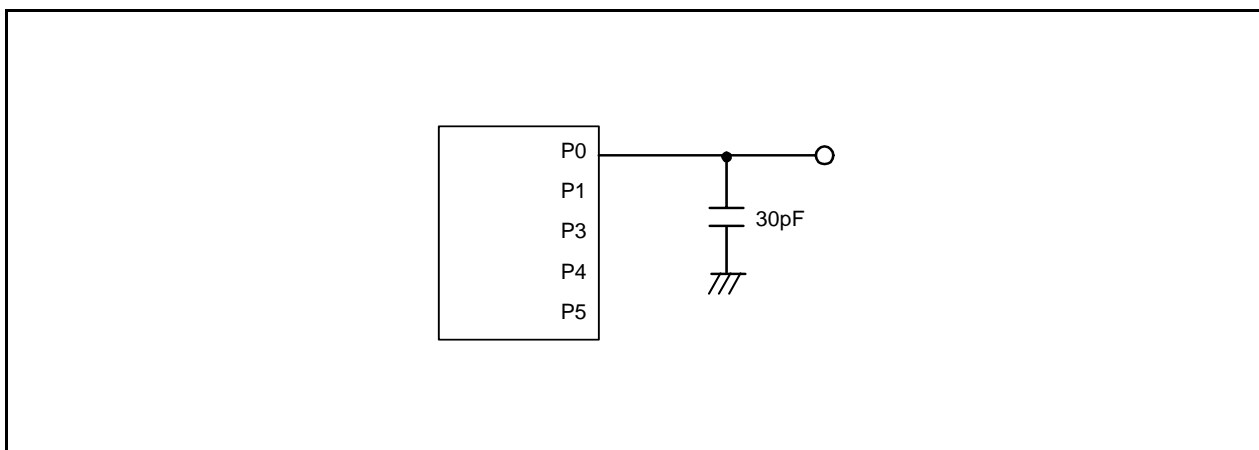

**Figure 5.1 Ports P0, P1, and P3 to P5 Timing Measurement Circuit**

**Table 5.4 Flash Memory (Program ROM) Electrical Characteristics**

Symbol	Parameter	Conditions	Standard			Unit
			Min.	Typ.	Max.	
–	Program/erase endurance <sup>(2)</sup>	R8C/26 Group	100 <sup>(3)</sup>	–	–	times
		R8C/27 Group	1,000 <sup>(3)</sup>	–	–	times
–	Byte program time		–	50	400	μs
–	Block erase time		–	0.4	9	s
t <sub>d</sub> (SR-SUS)	Time delay from suspend request until suspend		–	–	97 + CPU clock x 6 cycles	μs
–	Interval from erase start/restart until following suspend request		650	–	–	μs
–	Interval from program start/restart until following suspend request		0	–	–	ns
–	Time from suspend until program/erase restart		–	–	3 + CPU clock x 4 cycles	μs
–	Program, erase voltage		2.7	–	5.5	V
–	Read voltage		2.2	–	5.5	V
–	Program, erase temperature		0	–	60	°C
–	Data hold time <sup>(7)</sup>	Ambient temperature = 55°C	20	–	–	year

**NOTES:**

- V<sub>CC</sub> = 2.7 to 5.5 V at T<sub>opr</sub> = 0 to 60°C, unless otherwise specified.
- Definition of programming/erasure endurance  
The programming and erasure endurance is defined on a per-block basis.  
If the programming and erasure endurance is n (n = 100 or 1,000), each block can be erased n times. For example, if 1,024 1-byte writes are performed to different addresses in block A, a 1 Kbyte block, and then the block is erased, the programming/erasure endurance still stands at one.  
However, the same address must not be programmed more than once per erase operation (overwriting prohibited).
- Endurance to guarantee all electrical characteristics after program and erase. (1 to Min. value can be guaranteed).
- In a system that executes multiple programming operations, the actual erasure count can be reduced by writing to sequential addresses in turn so that as much of the block as possible is used up before performing an erase operation. For example, when programming groups of 16 bytes, the effective number of rewrites can be minimized by programming up to 128 groups before erasing them all in one operation. It is also advisable to retain data on the erasure endurance of each block and limit the number of erase operations to a certain number.
- If an error occurs during block erase, attempt to execute the clear status register command, then execute the block erase command at least three times until the erase error does not occur.
- Customers desiring program/erase failure rate information should contact their Renesas technical support representative.
- The data hold time includes time that the power supply is off or the clock is not supplied.

**Table 5.5 Flash Memory (Data flash Block A, Block B) Electrical Characteristics<sup>(4)</sup>**

Symbol	Parameter	Conditions	Standard			Unit
			Min.	Typ.	Max.	
–	Program/erase endurance <sup>(2)</sup>		10,000 <sup>(3)</sup>	–	–	times
–	Byte program time (program/erase endurance ≤ 1,000 times)		–	50	400	μs
–	Byte program time (program/erase endurance > 1,000 times)		–	65	–	μs
–	Block erase time (program/erase endurance ≤ 1,000 times)		–	0.2	9	s
–	Block erase time (program/erase endurance > 1,000 times)		–	0.3	–	s
t <sub>d</sub> (SR-SUS)	Time delay from suspend request until suspend		–	–	97 + CPU clock × 6 cycles	μs
–	Interval from erase start/restart until following suspend request		650	–	–	μs
–	Interval from program start/restart until following suspend request		0	–	–	ns
–	Time from suspend until program/erase restart		–	–	3 + CPU clock × 4 cycles	μs
–	Program, erase voltage		2.7	–	5.5	V
–	Read voltage		2.2	–	5.5	V
–	Program, erase temperature		-20 <sup>(8)</sup>	–	85	°C
–	Data hold time <sup>(9)</sup>	Ambient temperature = 55°C	20	–	–	year

**NOTES:**

- V<sub>CC</sub> = 2.7 to 5.5 V at T<sub>opr</sub> = -20 to 85°C (N version) / -40 to 85°C (D version), unless otherwise specified.
- Definition of programming/erasure endurance  
The programming and erasure endurance is defined on a per-block basis.  
If the programming and erasure endurance is n (n = 10,000), each block can be erased n times. For example, if 1,024 1-byte writes are performed to different addresses in block A, a 1 Kbyte block, and then the block is erased, the programming/erasure endurance still stands at one.  
However, the same address must not be programmed more than once per erase operation (overwriting prohibited).
- Endurance to guarantee all electrical characteristics after program and erase. (1 to Min. value can be guaranteed).
- Standard of block A and block B when program and erase endurance exceeds 1,000 times. Byte program time to 1,000 times is the same as that in program ROM.
- In a system that executes multiple programming operations, the actual erasure count can be reduced by writing to sequential addresses in turn so that as much of the block as possible is used up before performing an erase operation. For example, when programming groups of 16 bytes, the effective number of rewrites can be minimized by programming up to 128 groups before erasing them all in one operation. In addition, averaging the erasure endurance between blocks A and B can further reduce the actual erasure endurance. It is also advisable to retain data on the erasure endurance of each block and limit the number of erase operations to a certain number.
- If an error occurs during block erase, attempt to execute the clear status register command, then execute the block erase command at least three times until the erase error does not occur.
- Customers desiring program/erase failure rate information should contact their Renesas technical support representative.
- 40°C for D version.
- The data hold time includes time that the power supply is off or the clock is not supplied.

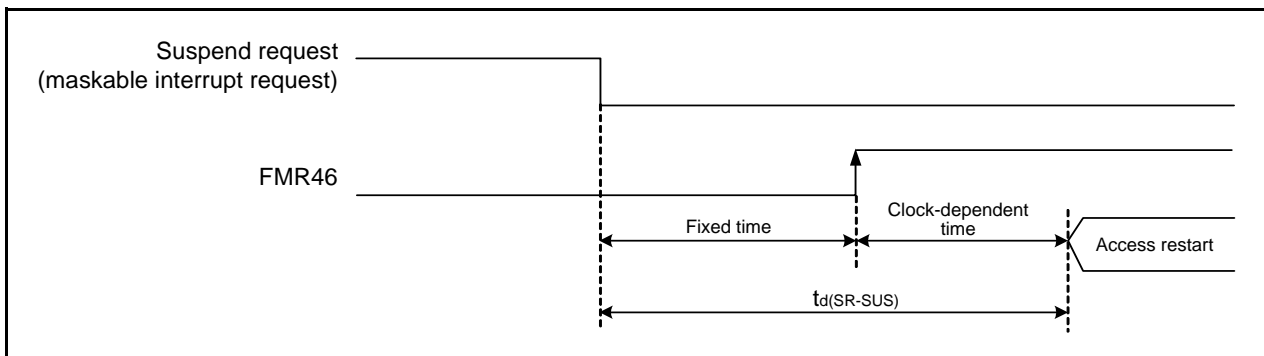

Figure 5.2 Time delay until Suspend

Table 5.6 Voltage Detection 0 Circuit Electrical Characteristics

Symbol	Parameter	Condition	Standard			Unit
			Min.	Typ.	Max.	
V <sub>det0</sub>	Voltage detection level		2.2	2.3	2.4	V
–	Voltage detection circuit self power consumption	VCA25 = 1, V <sub>CC</sub> = 5.0 V	–	0.9	–	μA
t <sub>d(E-A)</sub>	Waiting time until voltage detection circuit operation starts <sup>(2)</sup>		–	–	300	μs
V <sub>ccmin</sub>	MCU operating voltage minimum value		2.2	–	–	V

## NOTES:

1. The measurement condition is V<sub>CC</sub> = 2.2 to 5.5 V and T<sub>opr</sub> = -20 to 85°C (N version) / -40 to 85°C (D version).
2. Necessary time until the voltage detection circuit operates when setting to 1 again after setting the VCA25 bit in the VCA2 register to 0.

Table 5.7 Voltage Detection 1 Circuit Electrical Characteristics

Symbol	Parameter	Condition	Standard			Unit
			Min.	Typ.	Max.	
V <sub>det1</sub>	Voltage detection level <sup>(4)</sup>		2.70	2.85	3.00	V
–	Voltage monitor 1 interrupt request generation time <sup>(2)</sup>		–	40	–	μs
–	Voltage detection circuit self power consumption	VCA26 = 1, V <sub>CC</sub> = 5.0 V	–	0.6	–	μA
t <sub>d(E-A)</sub>	Waiting time until voltage detection circuit operation starts <sup>(3)</sup>		–	–	100	μs

## NOTES:

1. The measurement condition is V<sub>CC</sub> = 2.2 to 5.5 V and T<sub>opr</sub> = -20 to 85°C (N version) / -40 to 85°C (D version).
2. Time until the voltage monitor 1 interrupt request is generated after the voltage passes V<sub>det1</sub>.
3. Necessary time until the voltage detection circuit operates when setting to 1 again after setting the VCA26 bit in the VCA2 register to 0.
4. This parameter shows the voltage detection level when the power supply drops.  
The voltage detection level when the power supply rises is higher than the voltage detection level when the power supply drops by approximately 0.1 V.

Table 5.8 Voltage Detection 2 Circuit Electrical Characteristics

Symbol	Parameter	Condition	Standard			Unit
			Min.	Typ.	Max.	
V <sub>det2</sub>	Voltage detection level		3.3	3.6	3.9	V
–	Voltage monitor 2 interrupt request generation time <sup>(2)</sup>		–	40	–	μs
–	Voltage detection circuit self power consumption	VCA27 = 1, V <sub>CC</sub> = 5.0 V	–	0.6	–	μA
t <sub>d(E-A)</sub>	Waiting time until voltage detection circuit operation starts <sup>(3)</sup>		–	–	100	μs

## NOTES:

1. The measurement condition is V<sub>CC</sub> = 2.2 to 5.5 V and T<sub>opr</sub> = -20 to 85°C (N version) / -40 to 85°C (D version).
2. Time until the voltage monitor 2 interrupt request is generated after the voltage passes V<sub>det2</sub>.
3. Necessary time until the voltage detection circuit operates after setting to 1 again after setting the VCA27 bit in the VCA2 register to 0.

**Table 5.9 Power-on Reset Circuit, Voltage Monitor 0 Reset Electrical Characteristics<sup>(3)</sup>**

Symbol	Parameter	Condition	Standard			Unit
			Min.	Typ.	Max.	
V <sub>por1</sub>	Power-on reset valid voltage <sup>(4)</sup>		–	–	0.1	V
V <sub>por2</sub>	Power-on reset or voltage monitor 0 reset valid voltage		0	–	V <sub>det0</sub>	V
tr <sub>th</sub>	External power V <sub>CC</sub> rise gradient <sup>(2)</sup>		20	–	–	mV/msec

## NOTES:

1. The measurement condition is T<sub>opr</sub> = -20 to 85°C (N version) / -40 to 85°C (D version), unless otherwise specified.
2. This condition (external power V<sub>CC</sub> rise gradient) does not apply if V<sub>CC</sub> ≥ 1.0 V.
3. To use the power-on reset function, enable voltage monitor 0 reset by setting the LVD0ON bit in the OFS register to 0, the VW0C0 and VW0C6 bits in the VW0C register to 1 respectively, and the VCA25 bit in the VCA2 register to 1.
4. t<sub>w(por1)</sub> indicates the duration the external power V<sub>CC</sub> must be held below the effective voltage (V<sub>por1</sub>) to enable a power on reset. When turning on the power for the first time, maintain t<sub>w(por1)</sub> for 30 s or more if -20°C ≤ T<sub>opr</sub> ≤ 85°C, maintain t<sub>w(por1)</sub> for 3,000 s or more if -40°C ≤ T<sub>opr</sub> < -20°C.

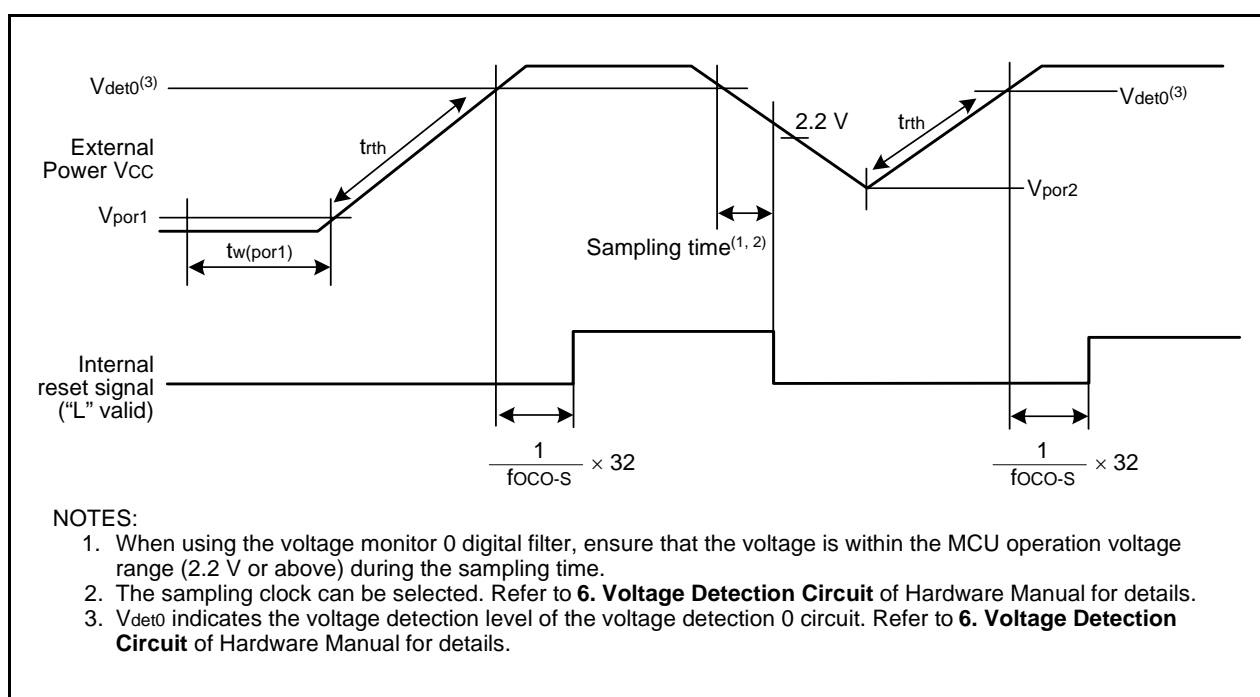
**Figure 5.3 Reset Circuit Electrical Characteristics**

**Table 5.10 High-speed On-Chip Oscillator Circuit Electrical Characteristics**

Symbol	Parameter	Condition	Standard			Unit
			Min.	Typ.	Max.	
fOCO40M	High-speed on-chip oscillator frequency temperature • supply voltage dependence	V <sub>CC</sub> = 4.75 to 5.25 V 0°C ≤ T <sub>opr</sub> ≤ 60°C <sup>(2)</sup>	39.2	40	40.8	MHz
		V <sub>CC</sub> = 3.0 to 5.5 V -20°C ≤ T <sub>opr</sub> ≤ 85°C <sup>(2)</sup>	38.8	40	41.2	MHz
		V <sub>CC</sub> = 3.0 to 5.5 V -40°C ≤ T <sub>opr</sub> ≤ 85°C <sup>(2)</sup>	38.4	40	41.6	MHz
		V <sub>CC</sub> = 2.7 to 5.5 V -20°C ≤ T <sub>opr</sub> ≤ 85°C <sup>(2)</sup>	38	40	42	MHz
		V <sub>CC</sub> = 2.7 to 5.5 V -40°C ≤ T <sub>opr</sub> ≤ 85°C <sup>(2)</sup>	37.6	40	42.4	MHz
		V <sub>CC</sub> = 2.2 to 5.5 V -20°C ≤ T <sub>opr</sub> ≤ 85°C <sup>(3)</sup>	35.2	40	44.8	MHz
		V <sub>CC</sub> = 2.2 to 5.5 V -40°C ≤ T <sub>opr</sub> ≤ 85°C <sup>(3)</sup>	34	40	46	MHz
		V <sub>CC</sub> = 5.0 V ± 10% -20°C ≤ T <sub>opr</sub> ≤ 85°C <sup>(2)</sup>	38.8	40	40.8	MHz
		V <sub>CC</sub> = 5.0 V ± 10% -40°C ≤ T <sub>opr</sub> ≤ 85°C <sup>(2)</sup>	38.4	40	40.8	MHz
		High-speed on-chip oscillator frequency when correction value in FRA7 register is written to FRA1 register <sup>(4)</sup>	V <sub>CC</sub> = 5.0 V, T <sub>opr</sub> = 25°C	–	36.864	–
V <sub>CC</sub> = 3.0 to 5.5 V -20°C ≤ T <sub>opr</sub> ≤ 85°C	-3%		–	3%	%	
–	Value in FRA1 register after reset		08h <sup>(3)</sup>	–	F7h <sup>(3)</sup>	–
–	Oscillation frequency adjustment unit of high-speed on-chip oscillator	Adjust FRA1 register (value after reset) to -1	–	+0.3	–	MHz
–	Oscillation stability time		–	10	100	μs
–	Self power consumption at oscillation	V <sub>CC</sub> = 5.0 V, T <sub>opr</sub> = 25°C	–	400	–	μA

## NOTES:

- V<sub>CC</sub> = 2.2 to 5.5 V, T<sub>opr</sub> = -20 to 85°C (N version) / -40 to 85°C (D version), unless otherwise specified.
- These standard values show when the FRA1 register value after reset is assumed.
- These standard values show when the corrected value of the FRA6 register is written to the FRA1 register.
- This enables the setting errors of bit rates such as 9600 bps and 38400 bps to be 0% when the serial interface is used in UART mode.

**Table 5.11 Low-speed On-Chip Oscillator Circuit Electrical Characteristics**

Symbol	Parameter	Condition	Standard			Unit
			Min.	Typ.	Max.	
fOCO-S	Low-speed on-chip oscillator frequency		30	125	250	kHz
–	Oscillation stability time		–	10	100	μs
–	Self power consumption at oscillation	V <sub>CC</sub> = 5.0 V, T <sub>opr</sub> = 25°C	–	15	–	μA

## NOTE:

- V<sub>CC</sub> = 2.2 to 5.5 V, T<sub>opr</sub> = -20 to 85°C (N version) / -40 to 85°C (D version), unless otherwise specified.

**Table 5.12 Power Supply Circuit Timing Characteristics**

Symbol	Parameter	Condition	Standard			Unit
			Min.	Typ.	Max.	
t <sub>d</sub> (P-R)	Time for internal power supply stabilization during power-on <sup>(2)</sup>		1	–	2000	μs
t <sub>d</sub> (R-S)	STOP exit time <sup>(3)</sup>		–	–	150	μs

## NOTES:

- The measurement condition is V<sub>CC</sub> = 2.2 to 5.5 V and T<sub>opr</sub> = 25°C.
- Waiting time until the internal power supply generation circuit stabilizes during power-on.
- Time until system clock supply starts after the interrupt is acknowledged to exit stop mode.



**Table 5.13 Timing Requirements of Clock Synchronous Serial I/O with Chip Select<sup>(1)</sup>**

Symbol	Parameter		Conditions	Standard			Unit
				Min.	Typ.	Max.	
tsucyc	SSCK clock cycle time			4	–	–	tcyc <sup>(2)</sup>
tHI	SSCK clock "H" width			0.4	–	0.6	tsucyc
tLO	SSCK clock "L" width			0.4	–	0.6	tsucyc
tRISE	SSCK clock rising time	Master		–	–	1	tcyc <sup>(2)</sup>
		Slave		–	–	1	μs
tFALL	SSCK clock falling time	Master		–	–	1	tcyc <sup>(2)</sup>
		Slave		–	–	1	μs
tsu	SSO, SSI data input setup time			100	–	–	ns
tH	SSO, SSI data input hold time			1	–	–	tcyc <sup>(2)</sup>
tLEAD	$\overline{\text{SCS}}$ setup time	Slave		1tcyc + 50	–	–	ns
tLAG	$\overline{\text{SCS}}$ hold time	Slave		1tcyc + 50	–	–	ns
tOD	SSO, SSI data output delay time			–	–	1	tcyc <sup>(2)</sup>
tSA	SSI slave access time		2.7 V ≤ Vcc ≤ 5.5 V	–	–	1.5tcyc + 100	ns
			2.2 V ≤ Vcc < 2.7 V	–	–	1.5tcyc + 200	ns
tOR	SSI slave out open time		2.7 V ≤ Vcc ≤ 5.5 V	–	–	1.5tcyc + 100	ns
			2.2 V ≤ Vcc < 2.7 V	–	–	1.5tcyc + 200	ns

## NOTES:

1. Vcc = 2.2 to 5.5 V, Vss = 0 V at Topr = -20 to 85°C (N version) / -40 to 85°C (D version), unless otherwise specified.
2. 1tcyc = 1/f1(s)

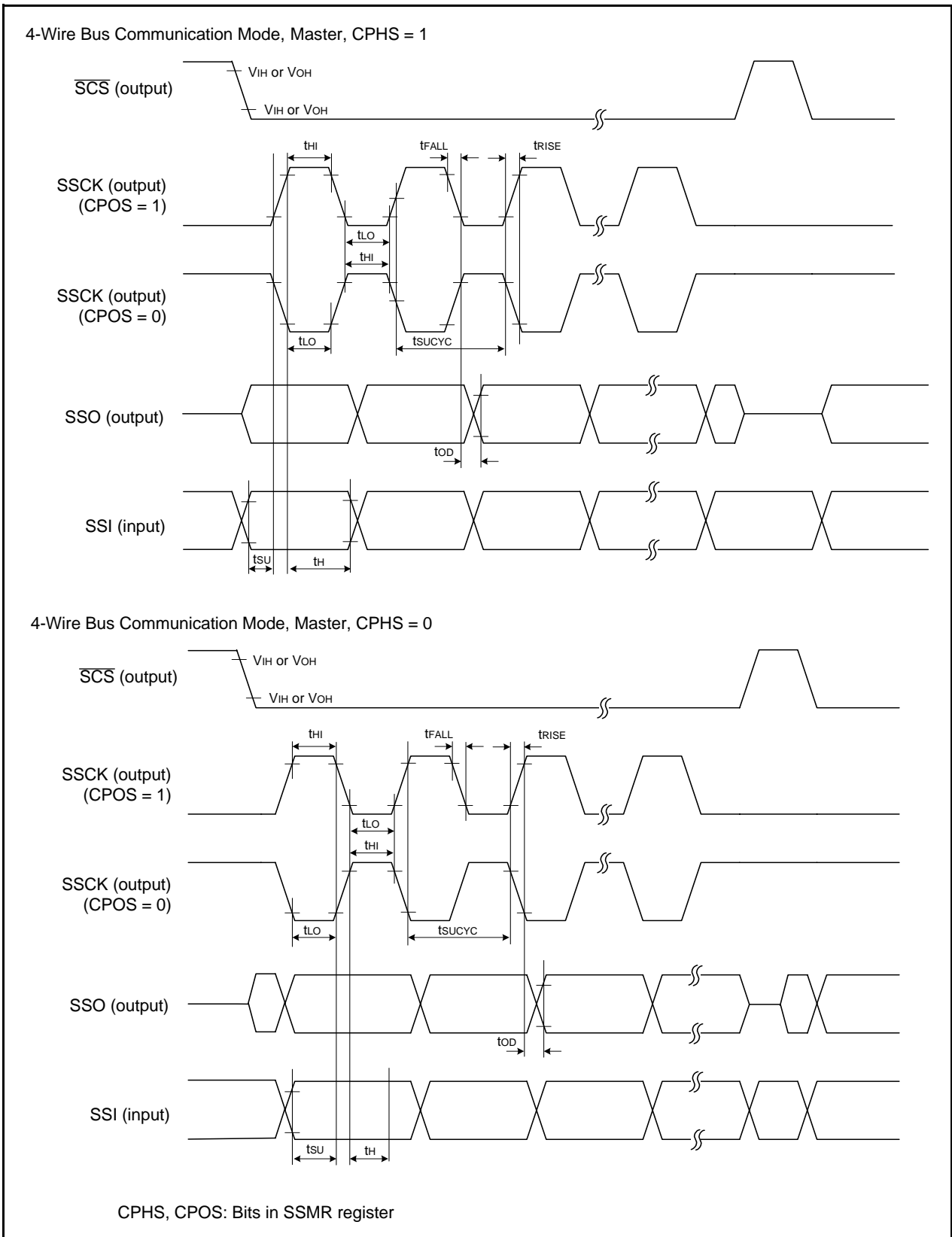

Figure 5.4 I/O Timing of Clock Synchronous Serial I/O with Chip Select (Master)

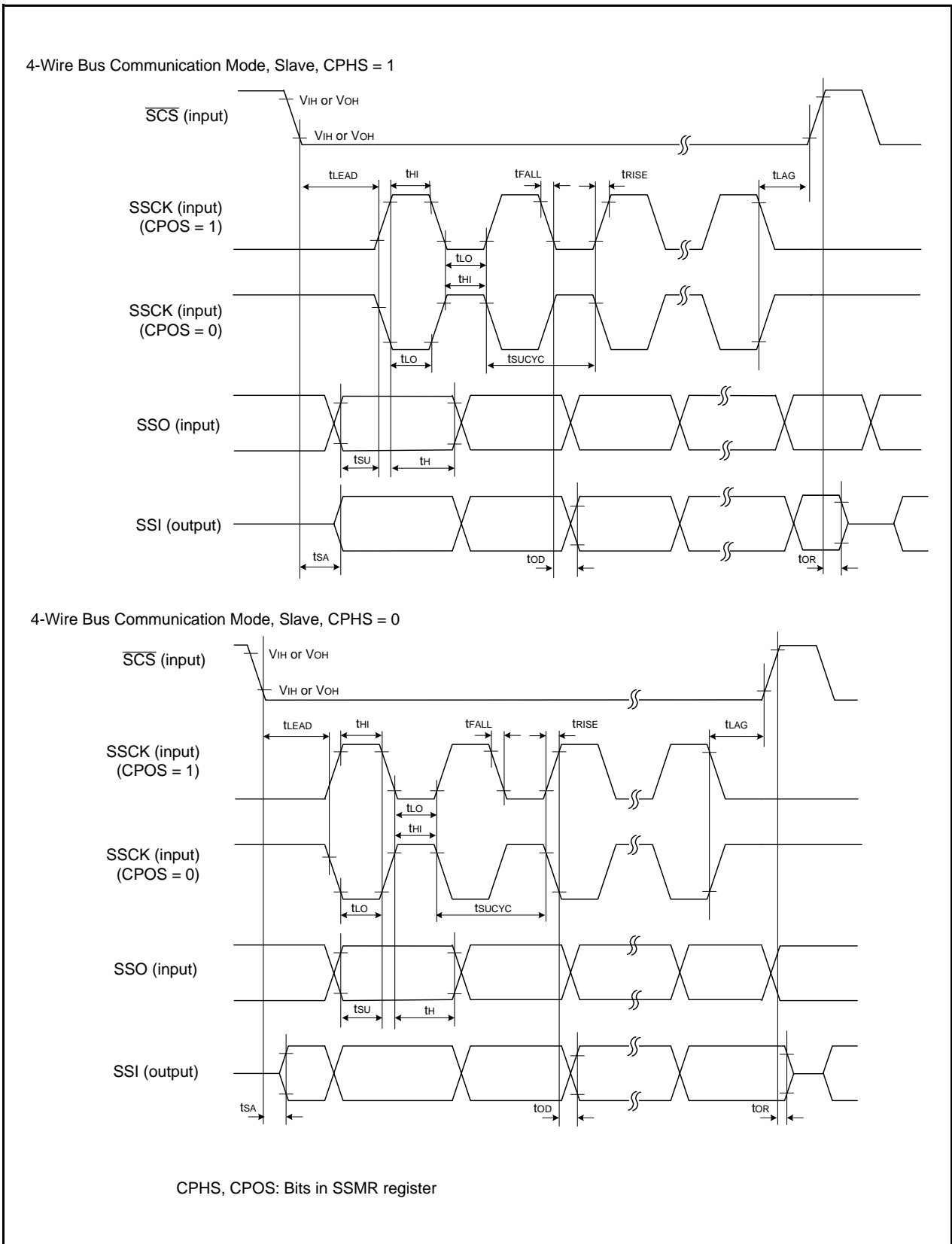
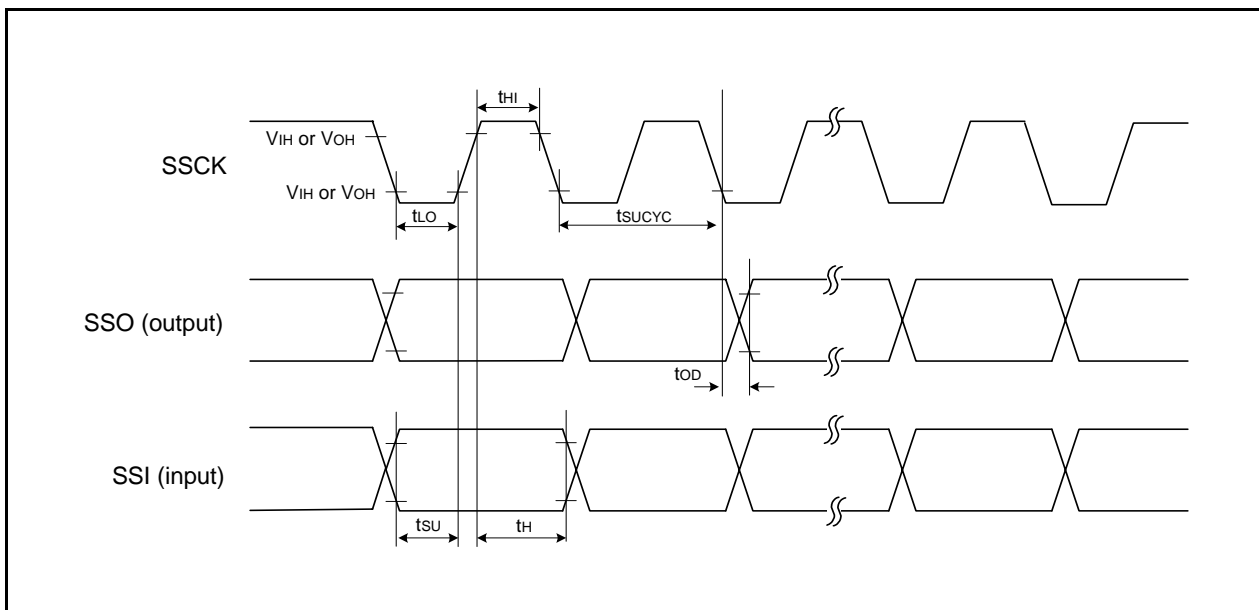

Figure 5.5 I/O Timing of Clock Synchronous Serial I/O with Chip Select (Slave)



**Figure 5.6 I/O Timing of Clock Synchronous Serial I/O with Chip Select (Clock Synchronous Communication Mode)**

**Table 5.14 Timing Requirements of I<sup>2</sup>C bus Interface<sup>(1)</sup>**

Symbol	Parameter	Condition	Standard			Unit
			Min.	Typ.	Max.	
t <sub>SCL</sub>	SCL input cycle time		12t <sub>CYC</sub> + 600 <sup>(2)</sup>	–	–	ns
t <sub>SCLH</sub>	SCL input “H” width		3t <sub>CYC</sub> + 300 <sup>(2)</sup>	–	–	ns
t <sub>SCLL</sub>	SCL input “L” width		5t <sub>CYC</sub> + 500 <sup>(2)</sup>	–	–	ns
t <sub>sf</sub>	SCL, SDA input fall time		–	–	300	ns
t <sub>SP</sub>	SCL, SDA input spike pulse rejection time		–	–	1t <sub>CYC</sub> <sup>(2)</sup>	ns
t <sub>BUF</sub>	SDA input bus-free time		5t <sub>CYC</sub> <sup>(2)</sup>	–	–	ns
t <sub>STAH</sub>	Start condition input hold time		3t <sub>CYC</sub> <sup>(2)</sup>	–	–	ns
t <sub>STAS</sub>	Retransmit start condition input setup time		3t <sub>CYC</sub> <sup>(2)</sup>	–	–	ns
t <sub>STOP</sub>	Stop condition input setup time		3t <sub>CYC</sub> <sup>(2)</sup>	–	–	ns
t <sub>SDAS</sub>	Data input setup time		1t <sub>CYC</sub> + 20 <sup>(2)</sup>	–	–	ns
t <sub>SDAH</sub>	Data input hold time		0	–	–	ns

## NOTES:

1. V<sub>CC</sub> = 2.2 to 5.5 V, V<sub>SS</sub> = 0 V and T<sub>opr</sub> = -20 to 85°C (N version) / -40 to 85°C (D version), unless otherwise specified.
2. 1t<sub>CYC</sub> = 1/f<sub>1</sub>(s)

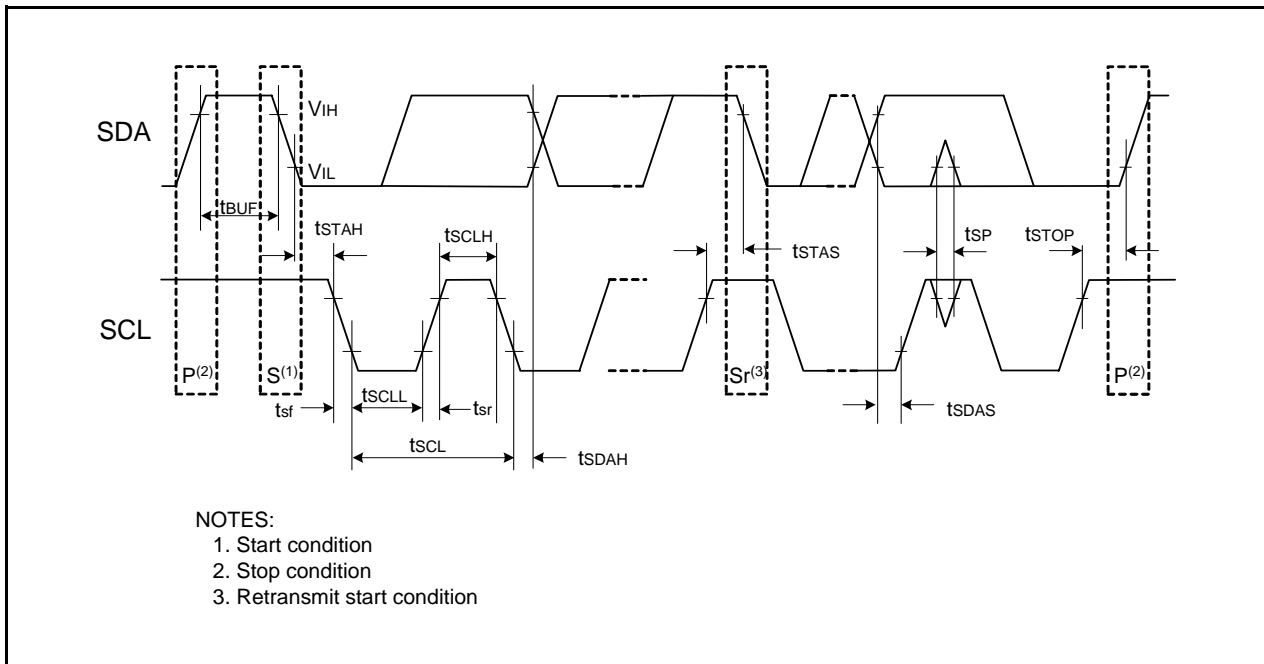
**Figure 5.7 I/O Timing of I<sup>2</sup>C bus Interface**

**Table 5.15 Electrical Characteristics (1) [V<sub>CC</sub> = 5 V]**

Symbol	Parameter		Condition	Standard			Unit		
				Min.	Typ.	Max.			
V <sub>OH</sub>	Output "H" voltage	Except P1_0 to P1_7, XOUT	I <sub>OH</sub> = -5 mA		V <sub>CC</sub> - 2.0	-	V <sub>CC</sub>	V	
			I <sub>OH</sub> = -200 μA		V <sub>CC</sub> - 0.5	-	V <sub>CC</sub>	V	
	P1_0 to P1_7		Drive capacity HIGH	I <sub>OH</sub> = -20 mA	V <sub>CC</sub> - 2.0	-	V <sub>CC</sub>	V	
			Drive capacity LOW	I <sub>OH</sub> = -5 mA	V <sub>CC</sub> - 2.0	-	V <sub>CC</sub>	V	
	XOUT		Drive capacity HIGH	I <sub>OH</sub> = -1 mA	V <sub>CC</sub> - 2.0	-	V <sub>CC</sub>	V	
			Drive capacity LOW	I <sub>OH</sub> = -500 μA	V <sub>CC</sub> - 2.0	-	V <sub>CC</sub>	V	
V <sub>OL</sub>	Output "L" voltage	Except P1_0 to P1_7, XOUT	I <sub>OL</sub> = 5 mA		-	-	2.0	V	
			I <sub>OL</sub> = 200 μA		-	-	0.45	V	
	P1_0 to P1_7		Drive capacity HIGH	I <sub>OL</sub> = 20 mA	-	-	2.0	V	
			Drive capacity LOW	I <sub>OL</sub> = 5 mA	-	-	2.0	V	
	XOUT		Drive capacity HIGH	I <sub>OL</sub> = 1 mA	-	-	2.0	V	
			Drive capacity LOW	I <sub>OL</sub> = 500 μA	-	-	2.0	V	
V <sub>T+</sub> -V <sub>T-</sub>	Hysteresis	$\overline{\text{INT0}}, \overline{\text{INT1}}, \overline{\text{INT3}},$ $\overline{\text{KI0}}, \overline{\text{KI1}}, \overline{\text{KI2}}, \overline{\text{KI3}},$ $\overline{\text{TRAIO}}, \overline{\text{RXD0}}, \overline{\text{RXD1}},$ $\overline{\text{CLK0}}, \overline{\text{CLK1}},$ $\overline{\text{SSI}}, \overline{\text{SCL}}, \overline{\text{SDA}}, \overline{\text{SSO}}$			0.1	0.5	-	V	
		$\overline{\text{RESET}}$			0.1	1.0	-	V	
I <sub>IH</sub>	Input "H" current			V <sub>I</sub> = 5 V, V <sub>CC</sub> = 5 V		-	-	5.0	μA
I <sub>IL</sub>	Input "L" current			V <sub>I</sub> = 0 V, V <sub>CC</sub> = 5 V		-	-	-5.0	μA
R <sub>PULLUP</sub>	Pull-up resistance			V <sub>I</sub> = 0 V, V <sub>CC</sub> = 5 V		30	50	167	kΩ
R <sub>fXIN</sub>	Feedback resistance	XIN			-	1.0	-	MΩ	
R <sub>fXCIN</sub>	Feedback resistance	XCIN			-	18	-	MΩ	
V <sub>RAM</sub>	RAM hold voltage			During stop mode		1.8	-	-	V

## NOTE:

- V<sub>CC</sub> = 4.2 to 5.5 V at T<sub>opr</sub> = -20 to 85°C (N version) / -40 to 85°C (D version), f(XIN) = 20 MHz, unless otherwise specified.

**Table 5.16 Electrical Characteristics (2) [V<sub>CC</sub> = 5 V]  
(T<sub>opr</sub> = -20 to 85°C (N version) / -40 to 85°C (D version), unless otherwise specified.)**

Symbol	Parameter	Condition	Standard			Unit	
			Min.	Typ.	Max.		
I <sub>CC</sub>	Power supply current (V <sub>CC</sub> = 3.3 to 5.5 V) Single-chip mode, output pins are open, other pins are V <sub>SS</sub>	High-speed clock mode	XIN = 20 MHz (square wave) High-speed on-chip oscillator off Low-speed on-chip oscillator on = 125 kHz No division	–	10	17	mA
			XIN = 16 MHz (square wave) High-speed on-chip oscillator off Low-speed on-chip oscillator on = 125 kHz No division	–	9	15	mA
			XIN = 10 MHz (square wave) High-speed on-chip oscillator off Low-speed on-chip oscillator on = 125 kHz No division	–	6	–	mA
			XIN = 20 MHz (square wave) High-speed on-chip oscillator off Low-speed on-chip oscillator on = 125 kHz Divide-by-8	–	5	–	mA
			XIN = 16 MHz (square wave) High-speed on-chip oscillator off Low-speed on-chip oscillator on = 125 kHz Divide-by-8	–	4	–	mA
			XIN = 10 MHz (square wave) High-speed on-chip oscillator off Low-speed on-chip oscillator on = 125 kHz Divide-by-8	–	2.5	–	mA
		High-speed on-chip oscillator mode	XIN clock off High-speed on-chip oscillator on f <sub>OCO</sub> = 20 MHz Low-speed on-chip oscillator on = 125 kHz No division	–	10	15	mA
			XIN clock off High-speed on-chip oscillator on f <sub>OCO</sub> = 20 MHz Low-speed on-chip oscillator on = 125 kHz Divide-by-8	–	4	–	mA
			XIN clock off High-speed on-chip oscillator on f <sub>OCO</sub> = 10 MHz Low-speed on-chip oscillator on = 125 kHz No division	–	5.5	10	mA
			XIN clock off High-speed on-chip oscillator on f <sub>OCO</sub> = 10 MHz Low-speed on-chip oscillator on = 125 kHz Divide-by-8	–	2.5	–	mA
		Low-speed on-chip oscillator mode	XIN clock off High-speed on-chip oscillator off Low-speed on-chip oscillator on = 125 kHz Divide-by-8, FMR47 = 1	–	130	300	μA
		Low-speed clock mode	XIN clock off High-speed on-chip oscillator off Low-speed on-chip oscillator off XCIN clock oscillator on = 32 kHz FMR47 = 1	–	130	300	μA
			XIN clock off High-speed on-chip oscillator off Low-speed on-chip oscillator off XCIN clock oscillator on = 32 kHz Program operation on RAM Flash memory off, FMSTP = 1	–	30	–	μA

**Table 5.17 Electrical Characteristics (3) [V<sub>CC</sub> = 5 V]  
(T<sub>opr</sub> = -20 to 85°C (N version) / -40 to 85°C (D version), unless otherwise specified.)**

Symbol	Parameter	Condition	Standard			Unit	
			Min.	Typ.	Max.		
I <sub>CC</sub>	Power supply current (V <sub>CC</sub> = 3.3 to 5.5 V) Single-chip mode, output pins are open, other pins are V <sub>SS</sub>	Wait mode	XIN clock off High-speed on-chip oscillator off Low-speed on-chip oscillator on = 125 kHz While a WAIT instruction is executed Peripheral clock operation VCA27 = VCA26 = VCA25 = 0 VCA20 = 1	–	25	75	μA
			XIN clock off High-speed on-chip oscillator off Low-speed on-chip oscillator on = 125 kHz While a WAIT instruction is executed Peripheral clock off VCA27 = VCA26 = VCA25 = 0 VCA20 = 1	–	23	60	μA
			XIN clock off High-speed on-chip oscillator off Low-speed on-chip oscillator off XCIN clock oscillator on = 32 kHz (high drive) While a WAIT instruction is executed VCA27 = VCA26 = VCA25 = 0 VCA20 = 1	–	4.0	–	μA
			XIN clock off High-speed on-chip oscillator off Low-speed on-chip oscillator off XCIN clock oscillator on = 32 kHz (low drive) While a WAIT instruction is executed VCA27 = VCA26 = VCA25 = 0 VCA20 = 1	–	2.2	–	μA
		Stop mode	XIN clock off, T <sub>opr</sub> = 25°C High-speed on-chip oscillator off Low-speed on-chip oscillator off CM10 = 1 Peripheral clock off VCA27 = VCA26 = VCA25 = 0	–	0.8	3.0	μA
			XIN clock off, T <sub>opr</sub> = 85°C High-speed on-chip oscillator off Low-speed on-chip oscillator off CM10 = 1 Peripheral clock off VCA27 = VCA26 = VCA25 = 0	–	1.2	–	μA



**Timing Requirements****(Unless Otherwise Specified:  $V_{CC} = 5\text{ V}$ ,  $V_{SS} = 0\text{ V}$  at  $T_{opr} = 25^{\circ}\text{C}$ ) [ $V_{CC} = 5\text{ V}$ ]****Table 5.18 XIN Input, XCIN Input**

Symbol	Parameter	Standard		Unit
		Min.	Max.	
$t_{c(XIN)}$	XIN input cycle time	50	–	ns
$t_{WH(XIN)}$	XIN input "H" width	25	–	ns
$t_{WL(XIN)}$	XIN input "L" width	25	–	ns
$t_{c(XCIN)}$	XCIN input cycle time	14	–	$\mu\text{s}$
$t_{WH(XCIN)}$	XCIN input "H" width	7	–	$\mu\text{s}$
$t_{WL(XCIN)}$	XCIN input "L" width	7	–	$\mu\text{s}$

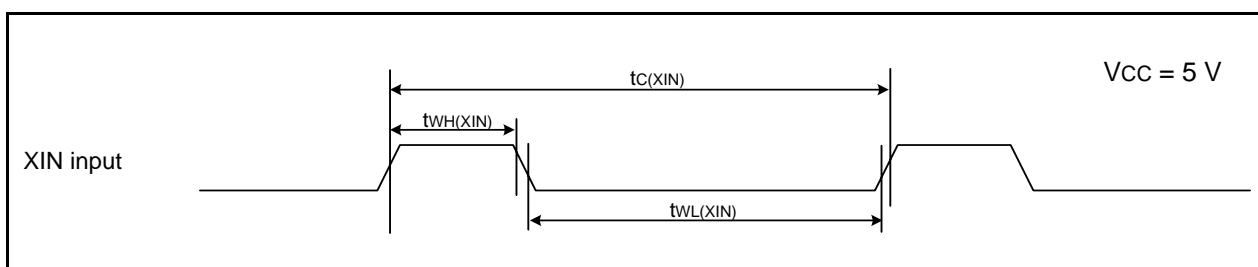
**Figure 5.8 XIN Input and XCIN Input Timing Diagram when  $V_{CC} = 5\text{ V}$** **Table 5.19 TRAI0 Input**

Symbol	Parameter	Standard		Unit
		Min.	Max.	
$t_{c(TRAIO)}$	TRAIO input cycle time	100	–	ns
$t_{WH(TRAIO)}$	TRAIO input "H" width	40	–	ns
$t_{WL(TRAIO)}$	TRAIO input "L" width	40	–	ns

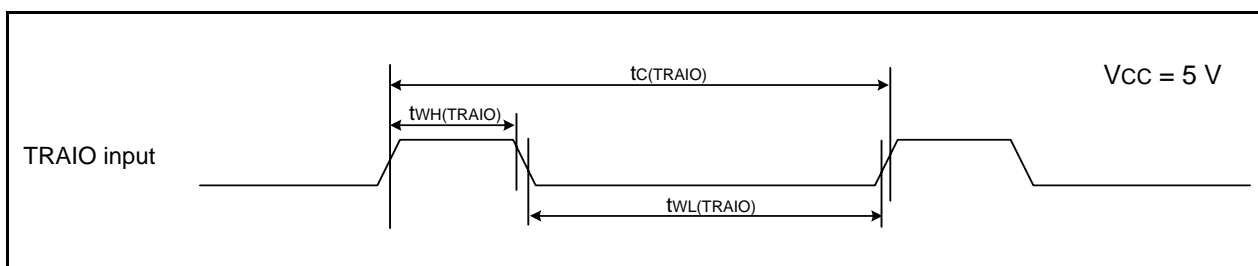
**Figure 5.9 TRAI0 Input Timing Diagram when  $V_{CC} = 5\text{ V}$**

**Table 5.20 Serial Interface**

Symbol	Parameter	Standard		Unit
		Min.	Max.	
$t_{c(CK)}$	CLKi input cycle time	200	–	ns
$t_{w(CKH)}$	CLKi input “H” width	100	–	ns
$t_{w(CKL)}$	CLKi input “L” width	100	–	ns
$t_{d(C-Q)}$	TXDi output delay time	–	50	ns
$t_{h(C-Q)}$	TXDi hold time	0	–	ns
$t_{su(D-C)}$	RXDi input setup time	50	–	ns
$t_{h(C-D)}$	RXDi input hold time	90	–	ns

$i = 0$  or  $1$

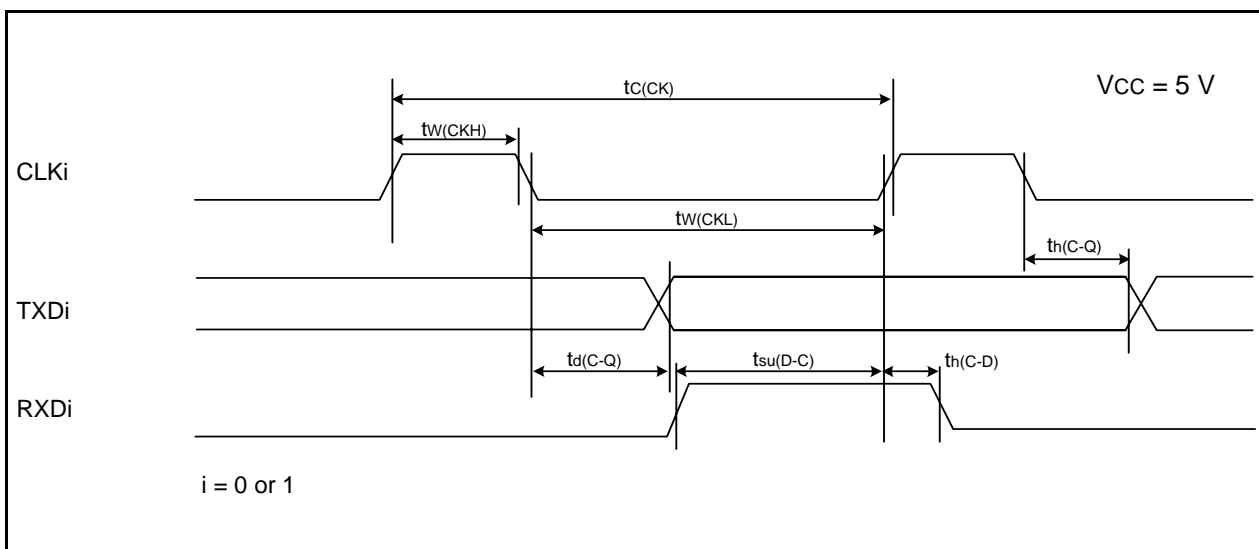

**Figure 5.10 Serial Interface Timing Diagram when Vcc = 5 V**

**Table 5.21 External Interrupt  $\overline{INTi}$  ( $i = 0, 1, 3$ ) Input**

Symbol	Parameter	Standard		Unit
		Min.	Max.	
$t_{w(INH)}$	$\overline{INTi}$ input “H” width	250 <sup>(1)</sup>	–	ns
$t_{w(INL)}$	$\overline{INTi}$ input “L” width	250 <sup>(2)</sup>	–	ns

NOTES:

1. When selecting the digital filter by the  $\overline{INTi}$  input filter select bit, use an  $\overline{INTi}$  input HIGH width of either (1/digital filter clock frequency × 3) or the minimum value of standard, whichever is greater.
2. When selecting the digital filter by the  $\overline{INTi}$  input filter select bit, use an  $\overline{INTi}$  input LOW width of either (1/digital filter clock frequency × 3) or the minimum value of standard, whichever is greater.

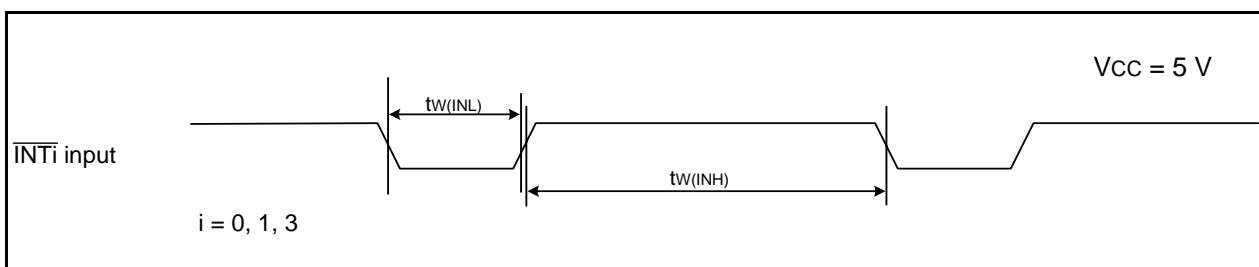

**Figure 5.11 External Interrupt  $\overline{INTi}$  Input Timing Diagram when Vcc = 5 V**

**Table 5.22 Electrical Characteristics (3) [V<sub>CC</sub> = 3 V]**

Symbol	Parameter		Condition		Standard			Unit		
					Min.	Typ.	Max.			
V <sub>OH</sub>	Output "H" voltage	Except P1_0 to P1_7, XOUT	I <sub>OH</sub> = -1 mA		V <sub>CC</sub> - 0.5	–	V <sub>CC</sub>	V		
		P1_0 to P1_7	Drive capacity HIGH	I <sub>OH</sub> = -5 mA	V <sub>CC</sub> - 0.5	–	V <sub>CC</sub>	V		
			Drive capacity LOW	I <sub>OH</sub> = -1 mA	V <sub>CC</sub> - 0.5	–	V <sub>CC</sub>	V		
		XOUT	Drive capacity HIGH	I <sub>OH</sub> = -0.1 mA	V <sub>CC</sub> - 0.5	–	V <sub>CC</sub>	V		
			Drive capacity LOW	I <sub>OH</sub> = -50 μA	V <sub>CC</sub> - 0.5	–	V <sub>CC</sub>	V		
V <sub>OL</sub>	Output "L" voltage	Except P1_0 to P1_7, XOUT	I <sub>OL</sub> = 1 mA		–	–	0.5	V		
		P1_0 to P1_7	Drive capacity HIGH	I <sub>OL</sub> = 5 mA	–	–	0.5	V		
			Drive capacity LOW	I <sub>OL</sub> = 1 mA	–	–	0.5	V		
		XOUT	Drive capacity HIGH	I <sub>OL</sub> = 0.1 mA	–	–	0.5	V		
			Drive capacity LOW	I <sub>OL</sub> = 50 μA	–	–	0.5	V		
V <sub>T+</sub> -V <sub>T-</sub>	Hysteresis	INT0, INT1, INT3, KI0, KI1, KI2, KI3, TRAIO, RXD0, RXD1, CLK0, CLK1, SSI, SCL, SDA, SSO			0.1	0.3	–	V		
		RESET			0.1	0.4	–	V		
I <sub>IH</sub>	Input "H" current			V <sub>I</sub> = 3 V, V <sub>CC</sub> = 3 V		–	–	4.0	μA	
I <sub>IL</sub>	Input "L" current			V <sub>I</sub> = 0 V, V <sub>CC</sub> = 3 V		–	–	-4.0	μA	
R <sub>PULLUP</sub>	Pull-up resistance			V <sub>I</sub> = 0 V, V <sub>CC</sub> = 3 V		66	160	500	kΩ	
R <sub>FXIN</sub>	Feedback resistance	XIN					–	3.0	–	MΩ
R <sub>FXCIN</sub>	Feedback resistance	XCIN					–	18	–	MΩ
V <sub>RAM</sub>	RAM hold voltage			During stop mode		1.8	–	–	V	

## NOTE:

- V<sub>CC</sub> = 2.7 to 3.3 V at T<sub>opr</sub> = -20 to 85°C (N version) / -40 to 85°C (D version), f(XIN) = 10 MHz, unless otherwise specified.

**Table 5.23 Electrical Characteristics (4) [V<sub>CC</sub> = 3 V]  
(T<sub>opr</sub> = -20 to 85°C (N version) / -40 to 85°C (D version), unless otherwise specified.)**

Symbol	Parameter	Condition	Standard			Unit	
			Min.	Typ.	Max.		
I <sub>CC</sub>	Power supply current (V <sub>CC</sub> = 2.7 to 3.3 V) Single-chip mode, output pins are open, other pins are V <sub>SS</sub>	High-speed clock mode	XIN = 10 MHz (square wave) High-speed on-chip oscillator off Low-speed on-chip oscillator on = 125 kHz No division	–	6	–	mA
			XIN = 10 MHz (square wave) High-speed on-chip oscillator off Low-speed on-chip oscillator on = 125 kHz Divide-by-8	–	2	–	mA
		High-speed on-chip oscillator mode	XIN clock off High-speed on-chip oscillator on f <sub>OCO</sub> = 10 MHz Low-speed on-chip oscillator on = 125 kHz No division	–	5	9	mA
			XIN clock off High-speed on-chip oscillator on f <sub>OCO</sub> = 10 MHz Low-speed on-chip oscillator on = 125 kHz Divide-by-8	–	2	–	mA
		Low-speed on-chip oscillator mode	XIN clock off High-speed on-chip oscillator off Low-speed on-chip oscillator on = 125 kHz Divide-by-8, FMR47 = 1	–	130	300	μA
		Low-speed clock mode	XIN clock off High-speed on-chip oscillator off Low-speed on-chip oscillator off XCIN clock oscillator on = 32 kHz FMR47 = 1	–	130	300	μA
			XIN clock off High-speed on-chip oscillator off Low-speed on-chip oscillator off XCIN clock oscillator on = 32 kHz Program operation on RAM Flash memory off, FMSTP = 1	–	30	–	μA
		Wait mode	XIN clock off High-speed on-chip oscillator off Low-speed on-chip oscillator on = 125 kHz While a WAIT instruction is executed Peripheral clock operation VCA27 = VCA26 = VCA25 = 0 VCA20 = 1	–	25	70	μA
			XIN clock off High-speed on-chip oscillator off Low-speed on-chip oscillator on = 125 kHz While a WAIT instruction is executed Peripheral clock off VCA27 = VCA26 = VCA25 = 0 VCA20 = 1	–	23	55	μA
			XIN clock off High-speed on-chip oscillator off Low-speed on-chip oscillator off XCIN clock oscillator on = 32 kHz (high drive) While a WAIT instruction is executed VCA27 = VCA26 = VCA25 = 0 VCA20 = 1	–	3.8	–	μA
			XIN clock off High-speed on-chip oscillator off Low-speed on-chip oscillator off XCIN clock oscillator on = 32 kHz (low drive) While a WAIT instruction is executed VCA27 = VCA26 = VCA25 = 0 VCA20 = 1	–	2.0	–	μA
		Stop mode	XIN clock off, T <sub>opr</sub> = 25°C High-speed on-chip oscillator off Low-speed on-chip oscillator off CM10 = 1 Peripheral clock off VCA27 = VCA26 = VCA25 = 0	–	0.7	3.0	μA
			XIN clock off, T <sub>opr</sub> = 85°C High-speed on-chip oscillator off Low-speed on-chip oscillator off CM10 = 1 Peripheral clock off VCA27 = VCA26 = VCA25 = 0	–	1.1	–	μA

**Timing requirements****(Unless Otherwise Specified:  $V_{CC} = 3\text{ V}$ ,  $V_{SS} = 0\text{ V}$  at  $T_{opr} = 25^{\circ}\text{C}$ ) [ $V_{CC} = 3\text{ V}$ ]****Table 5.24 XIN Input, XCIN Input**

Symbol	Parameter	Standard		Unit
		Min.	Max.	
$t_{c(XIN)}$	XIN input cycle time	100	–	ns
$t_{WH(XIN)}$	XIN input "H" width	40	–	ns
$t_{WL(XIN)}$	XIN input "L" width	40	–	ns
$t_{c(XCIN)}$	XCIN input cycle time	14	–	$\mu\text{s}$
$t_{WH(XCIN)}$	XCIN input "H" width	7	–	$\mu\text{s}$
$t_{WL(XCIN)}$	XCIN input "L" width	7	–	$\mu\text{s}$

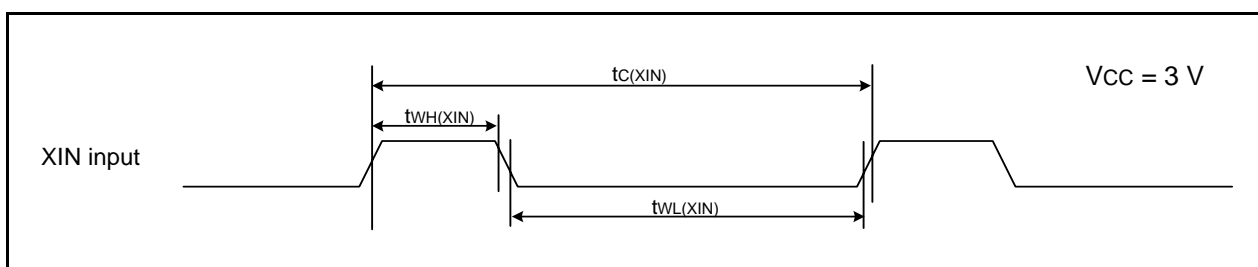
**Figure 5.12 XIN Input and XCIN Input Timing Diagram when  $V_{CC} = 3\text{ V}$** **Table 5.25 TRAI0 Input**

Symbol	Parameter	Standard		Unit
		Min.	Max.	
$t_{c(TRAIO)}$	TRAIO input cycle time	300	–	ns
$t_{WH(TRAIO)}$	TRAIO input "H" width	120	–	ns
$t_{WL(TRAIO)}$	TRAIO input "L" width	120	–	ns

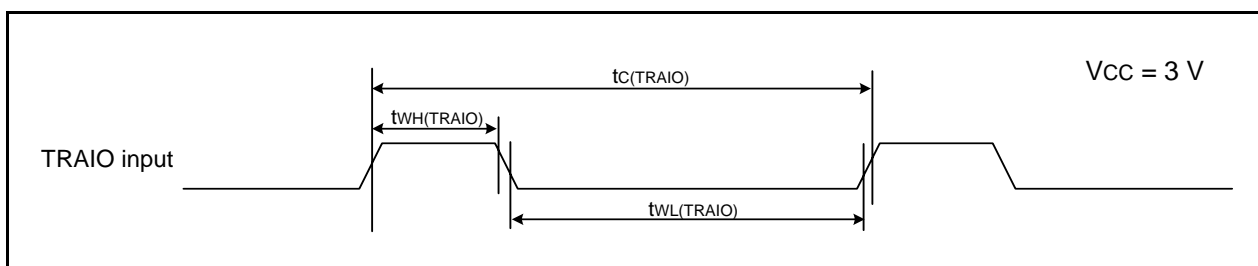
**Figure 5.13 TRAI0 Input Timing Diagram when  $V_{CC} = 3\text{ V}$**

**Table 5.26 Serial Interface**

Symbol	Parameter	Standard		Unit
		Min.	Max.	
$t_{c(CK)}$	CLKi input cycle time	300	–	ns
$t_{w(CKH)}$	CLKi input “H” width	150	–	ns
$t_{w(CKL)}$	CLKi Input “L” width	150	–	ns
$t_{d(C-Q)}$	TXDi output delay time	–	80	ns
$t_{h(C-Q)}$	TXDi hold time	0	–	ns
$t_{su(D-C)}$	RXDi input setup time	70	–	ns
$t_{h(C-D)}$	RXDi input hold time	90	–	ns

i = 0 or 1

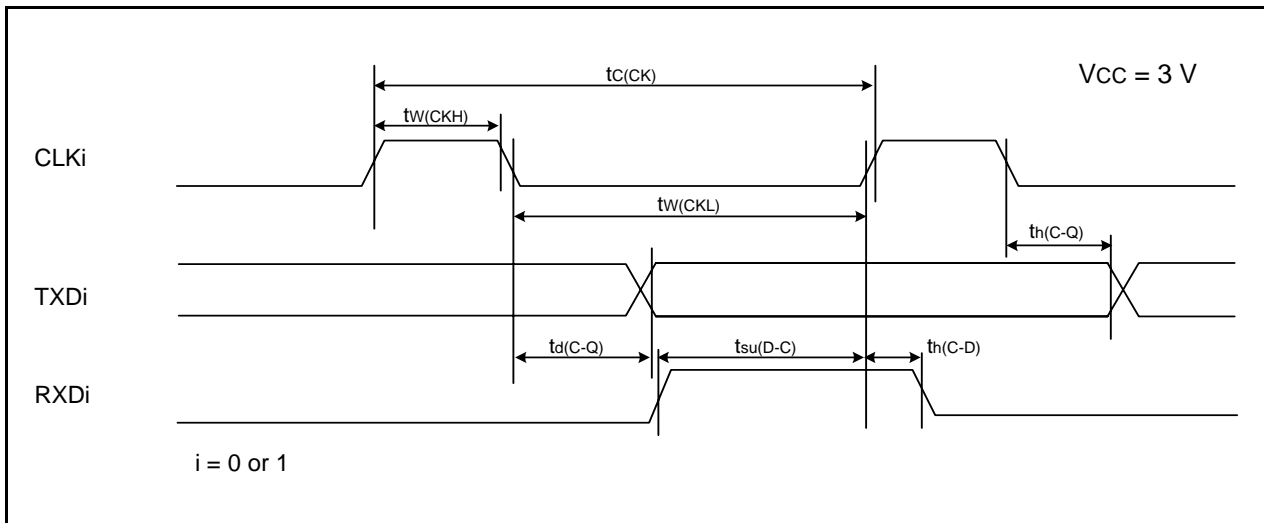
**Figure 5.14 Serial Interface Timing Diagram when Vcc = 3 V****Table 5.27 External Interrupt  $\overline{INTi}$  (i = 0, 1, 3) Input**

Symbol	Parameter	Standard		Unit
		Min.	Max.	
$t_{w(INH)}$	$\overline{INTi}$ input “H” width	380 <sup>(1)</sup>	–	ns
$t_{w(INL)}$	$\overline{INTi}$ input “L” width	380 <sup>(2)</sup>	–	ns

## NOTES:

- When selecting the digital filter by the  $\overline{INTi}$  input filter select bit, use an  $\overline{INTi}$  input HIGH width of either (1/digital filter clock frequency × 3) or the minimum value of standard, whichever is greater.
- When selecting the digital filter by the  $\overline{INTi}$  input filter select bit, use an  $\overline{INTi}$  input LOW width of either (1/digital filter clock frequency × 3) or the minimum value of standard, whichever is greater.

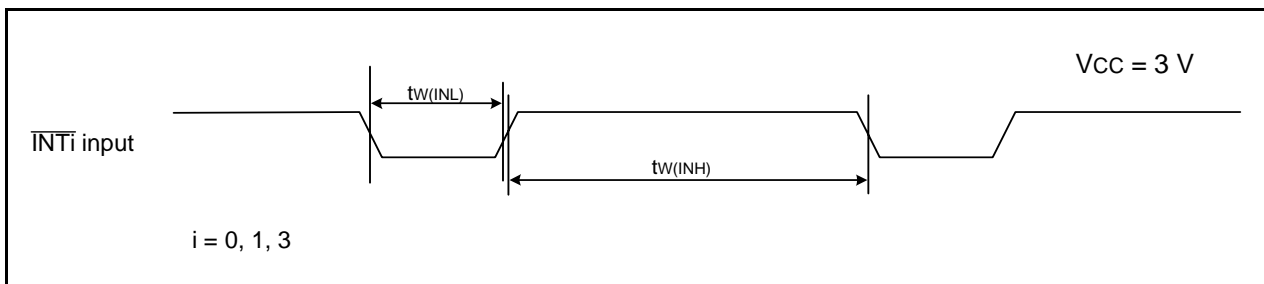
**Figure 5.15 External Interrupt  $\overline{INTi}$  Input Timing Diagram when Vcc = 3 V**

**Table 5.28 Electrical Characteristics (5) [V<sub>CC</sub> = 2.2 V]**

Symbol	Parameter		Condition		Standard			Unit
					Min.	Typ.	Max.	
V <sub>OH</sub>	Output "H" voltage	Except P1_0 to P1_7, XOUT	I <sub>OH</sub> = -1 mA		V <sub>CC</sub> - 0.5	–	V <sub>CC</sub>	V
		P1_0 to P1_7	Drive capacity HIGH	I <sub>OH</sub> = -2 mA	V <sub>CC</sub> - 0.5	–	V <sub>CC</sub>	V
			Drive capacity LOW	I <sub>OH</sub> = -1 mA	V <sub>CC</sub> - 0.5	–	V <sub>CC</sub>	V
		XOUT	Drive capacity HIGH	I <sub>OH</sub> = -0.1 mA	V <sub>CC</sub> - 0.5	–	V <sub>CC</sub>	V
			Drive capacity LOW	I <sub>OH</sub> = -50 μA	V <sub>CC</sub> - 0.5	–	V <sub>CC</sub>	V
V <sub>OL</sub>	Output "L" voltage	Except P1_0 to P1_7, XOUT	I <sub>OL</sub> = 1 mA		–	–	0.5	V
		P1_0 to P1_7	Drive capacity HIGH	I <sub>OL</sub> = 2 mA	–	–	0.5	V
			Drive capacity LOW	I <sub>OL</sub> = 1 mA	–	–	0.5	V
		XOUT	Drive capacity HIGH	I <sub>OL</sub> = 0.1 mA	–	–	0.5	V
			Drive capacity LOW	I <sub>OL</sub> = 50 μA	–	–	0.5	V
V <sub>T+</sub> -V <sub>T-</sub>	Hysteresis	$\overline{\text{INT0}}, \overline{\text{INT1}}, \overline{\text{INT3}},$ $\text{KI0}, \text{KI1}, \text{KI2}, \text{KI3},$ $\text{TRAIO}, \text{RXD0}, \text{RXD1},$ $\text{CLK0}, \text{CLK1},$ $\text{SSI}, \text{SCL}, \text{SDA}, \text{SSO}$			0.05	0.3	–	V
		$\overline{\text{RESET}}$			0.05	0.15	–	V
I <sub>IH</sub>	Input "H" current	V <sub>I</sub> = 2.2 V		–	–	4.0	μA	
I <sub>IL</sub>	Input "L" current	V <sub>I</sub> = 0 V		–	–	-4.0	μA	
R <sub>PULLUP</sub>	Pull-up resistance	V <sub>I</sub> = 0 V		100	200	600	kΩ	
R <sub>FXIN</sub>	Feedback resistance	XIN			–	5	–	MΩ
R <sub>FXCIN</sub>	Feedback resistance	XCIN			–	35	–	MΩ
V <sub>RAM</sub>	RAM hold voltage	During stop mode		1.8	–	–	V	

## NOTE:

- V<sub>CC</sub> = 2.2 V at T<sub>opr</sub> = -20 to 85°C (N version) / -40 to 85°C (D version), f(XIN) = 5 MHz, unless otherwise specified.

**Table 5.29 Electrical Characteristics (6) [V<sub>CC</sub> = 2.2 V]  
(T<sub>opr</sub> = -20 to 85°C (N version) / -40 to 85°C (D version), unless otherwise specified.)**

Symbol	Parameter	Condition	Standard			Unit	
			Min.	Typ.	Max.		
I <sub>CC</sub>	Power supply current (V <sub>CC</sub> = 2.2 to 2.7 V) Single-chip mode, output pins are open, other pins are V <sub>SS</sub>	High-speed clock mode	XIN = 5 MHz (square wave) High-speed on-chip oscillator off Low-speed on-chip oscillator on = 125 kHz No division	–	3.5	–	mA
			XIN = 5 MHz (square wave) High-speed on-chip oscillator off Low-speed on-chip oscillator on = 125 kHz Divide-by-8	–	1.5	–	mA
		High-speed on-chip oscillator mode	XIN clock off High-speed on-chip oscillator on f <sub>OCO</sub> = 5 MHz Low-speed on-chip oscillator on = 125 kHz No division	–	3.5	–	mA
			XIN clock off High-speed on-chip oscillator on f <sub>OCO</sub> = 5 MHz Low-speed on-chip oscillator on = 125 kHz Divide-by-8	–	1.5	–	mA
		Low-speed on-chip oscillator mode	XIN clock off High-speed on-chip oscillator off Low-speed on-chip oscillator on = 125 kHz Divide-by-8, FMR47 = 1	–	100	230	μA
		Low-speed clock mode	XIN clock off High-speed on-chip oscillator off Low-speed on-chip oscillator off XCIN clock oscillator on = 32 kHz FMR47 = 1	–	100	230	μA
			XIN clock off High-speed on-chip oscillator off Low-speed on-chip oscillator off XCIN clock oscillator on = 32 kHz Program operation on RAM Flash memory off, FMSTP = 1	–	25	–	μA
		Wait mode	XIN clock off High-speed on-chip oscillator off Low-speed on-chip oscillator on = 125 kHz While a WAIT instruction is executed Peripheral clock operation VCA27 = VCA26 = VCA25 = 0 VCA20 = 1	–	22	60	μA
			XIN clock off High-speed on-chip oscillator off Low-speed on-chip oscillator on = 125 kHz While a WAIT instruction is executed Peripheral clock off VCA27 = VCA26 = VCA25 = 0 VCA20 = 1	–	20	55	μA
			XIN clock off High-speed on-chip oscillator off Low-speed on-chip oscillator off XCIN clock oscillator on = 32 kHz (high drive) While a WAIT instruction is executed VCA27 = VCA26 = VCA25 = 0 VCA20 = 1	–	3.0	–	μA
			XIN clock off High-speed on-chip oscillator off Low-speed on-chip oscillator off XCIN clock oscillator on = 32 kHz (low drive) While a WAIT instruction is executed VCA27 = VCA26 = VCA25 = 0 VCA20 = 1	–	1.8	–	μA
		Stop mode	XIN clock off, T <sub>opr</sub> = 25°C High-speed on-chip oscillator off Low-speed on-chip oscillator off CM10 = 1 Peripheral clock off VCA27 = VCA26 = VCA25 = 0	–	0.7	3.0	μA
			XIN clock off, T <sub>opr</sub> = 85°C High-speed on-chip oscillator off Low-speed on-chip oscillator off CM10 = 1 Peripheral clock off VCA27 = VCA26 = VCA25 = 0	–	1.1	–	μA



**Timing requirements****(Unless Otherwise Specified:  $V_{CC} = 2.2\text{ V}$ ,  $V_{SS} = 0\text{ V}$  at  $T_{opr} = 25^{\circ}\text{C}$ ) [ $V_{CC} = 2.2\text{ V}$ ]****Table 5.30 XIN Input, XCIN Input**

Symbol	Parameter	Standard		Unit
		Min.	Max.	
$t_{c(XIN)}$	XIN input cycle time	200	–	ns
$t_{WH(XIN)}$	XIN input "H" width	90	–	ns
$t_{WL(XIN)}$	XIN input "L" width	90	–	ns
$t_{c(XCIN)}$	XCIN input cycle time	14	–	$\mu\text{s}$
$t_{WH(XCIN)}$	XCIN input "H" width	7	–	$\mu\text{s}$
$t_{WL(XCIN)}$	XCIN input "L" width	7	–	$\mu\text{s}$

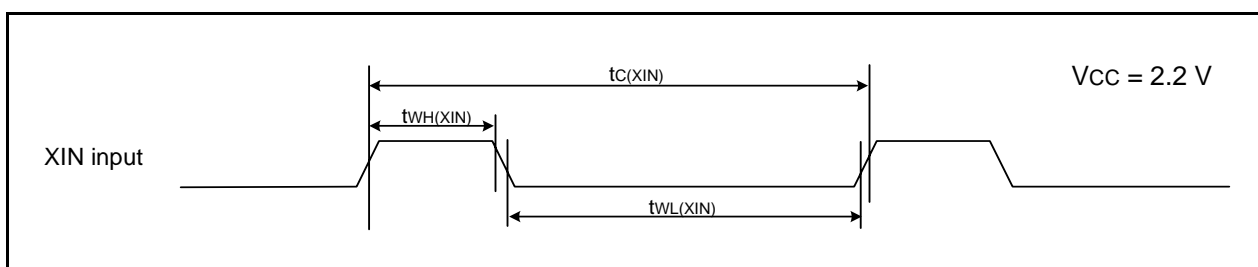
**Figure 5.16 XIN Input and XCIN Input Timing Diagram when  $V_{CC} = 2.2\text{ V}$** **Table 5.31 TRAI0 Input**

Symbol	Parameter	Standard		Unit
		Min.	Max.	
$t_{c(TRAIO)}$	TRAIO input cycle time	500	–	ns
$t_{WH(TRAIO)}$	TRAIO input "H" width	200	–	ns
$t_{WL(TRAIO)}$	TRAIO input "L" width	200	–	ns

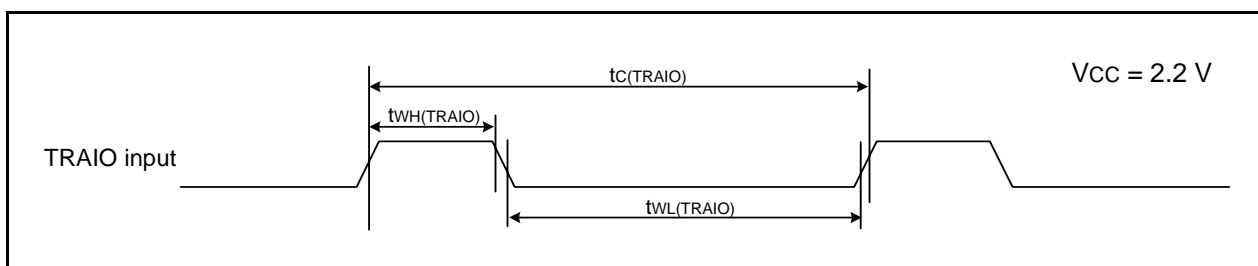
**Figure 5.17 TRAI0 Input Timing Diagram when  $V_{CC} = 2.2\text{ V}$**

**Table 5.32 Serial Interface**

Symbol	Parameter	Standard		Unit
		Min.	Max.	
$t_{c(CK)}$	CLKi input cycle time	800	–	ns
$t_{w(CKH)}$	CLKi input “H” width	400	–	ns
$t_{w(CKL)}$	CLKi input “L” width	400	–	ns
$t_{d(C-Q)}$	TXDi output delay time	–	200	ns
$t_{h(C-Q)}$	TXDi hold time	0	–	ns
$t_{su(D-C)}$	RXDi input setup time	150	–	ns
$t_{h(C-D)}$	RXDi input hold time	90	–	ns

i = 0 or 1

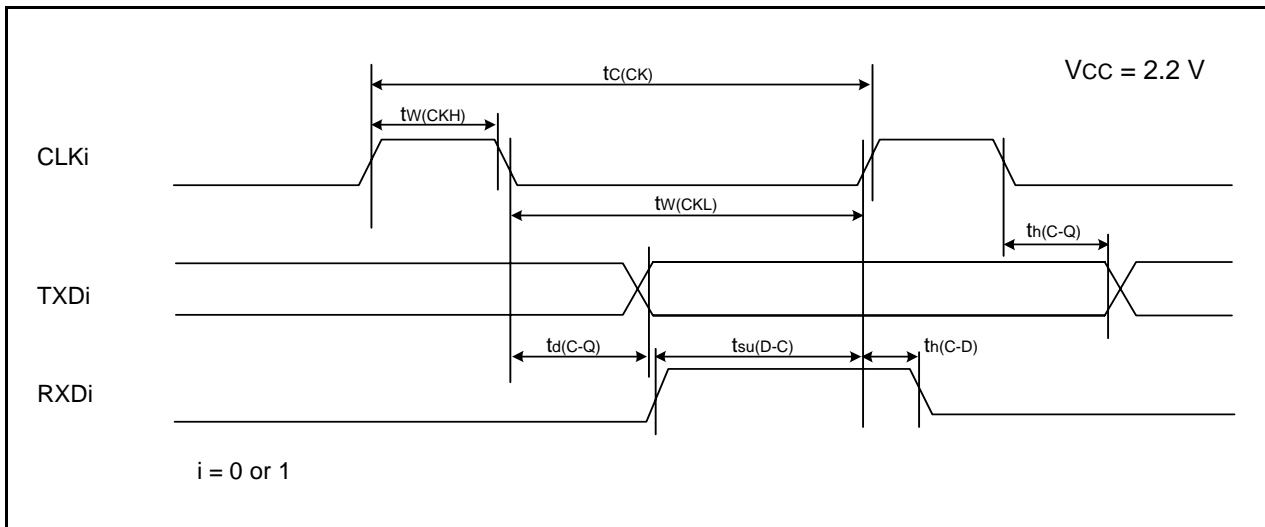
**Figure 5.18 Serial Interface Timing Diagram when Vcc = 2.2 V****Table 5.33 External Interrupt  $\overline{INTi}$  (i = 0, 1, 3) Input**

Symbol	Parameter	Standard		Unit
		Min.	Max.	
$t_{w(INH)}$	$\overline{INTi}$ input “H” width	1000 <sup>(1)</sup>	–	ns
$t_{w(INL)}$	$\overline{INTi}$ input “L” width	1000 <sup>(2)</sup>	–	ns

## NOTES:

- When selecting the digital filter by the  $\overline{INTi}$  input filter select bit, use an  $\overline{INTi}$  input HIGH width of either (1/digital filter clock frequency × 3) or the minimum value of standard, whichever is greater.
- When selecting the digital filter by the  $\overline{INTi}$  input filter select bit, use an  $\overline{INTi}$  input LOW width of either (1/digital filter clock frequency × 3) or the minimum value of standard, whichever is greater.

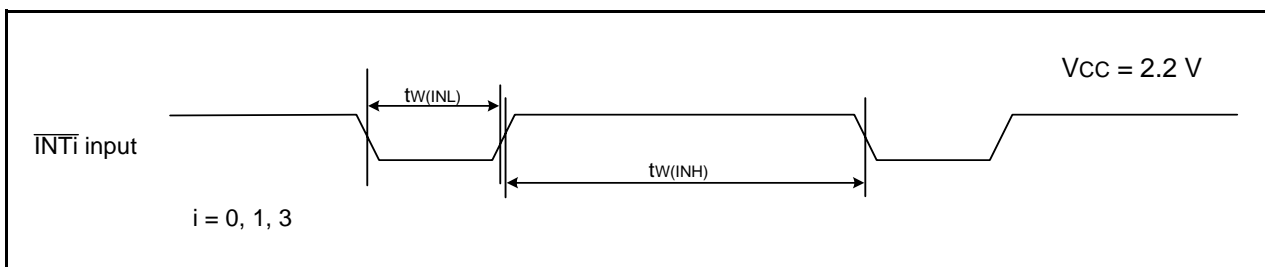
**Figure 5.19 External Interrupt  $\overline{INTi}$  Input Timing Diagram when Vcc = 2.2 V**

## 5.2 J, K Version

**Table 5.34 Absolute Maximum Ratings**

Symbol	Parameter	Condition	Rated Value	Unit
V <sub>CC</sub> /AV <sub>CC</sub>	Supply voltage		-0.3 to 6.5	V
V <sub>I</sub>	Input voltage		-0.3 to V <sub>CC</sub> + 0.3	V
V <sub>O</sub>	Output voltage		-0.3 to V <sub>CC</sub> + 0.3	V
P <sub>d</sub>	Power dissipation	-40 °C ≤ T <sub>opr</sub> ≤ 85 °C	300	mW
		85 °C ≤ T <sub>opr</sub> ≤ 125 °C	125	mW
T <sub>opr</sub>	Operating ambient temperature		-40 to 85 (J version) / -40 to 125 (K version)	°C
T <sub>stg</sub>	Storage temperature		-65 to 150	°C

**Table 5.35 Recommended Operating Conditions**

Symbol	Parameter		Conditions	Standard			Unit		
				Min.	Typ.	Max.			
V <sub>CC</sub> /AV <sub>CC</sub>	Supply voltage			2.7	–	5.5	V		
V <sub>SS</sub> /AV <sub>SS</sub>	Supply voltage			–	0	–	V		
V <sub>IH</sub>	Input “H” voltage			0.8 V <sub>CC</sub>	–	V <sub>CC</sub>	V		
V <sub>IL</sub>	Input “L” voltage			0	–	0.2 V <sub>CC</sub>	V		
I <sub>OH(sum)</sub>	Peak sum output “H” current	Sum of all pins I <sub>OH(peak)</sub>		–	–	-60	mA		
I <sub>OH(peak)</sub>	Peak output “H” current			–	–	-10	mA		
I <sub>OH(avg)</sub>	Average output “H” current			–	–	-5	mA		
I <sub>OL(sum)</sub>	Peak sum output “L” currents	Sum of all pins I <sub>OL(peak)</sub>		–	–	60	mA		
I <sub>OL(peak)</sub>	Peak output “L” currents			–	–	10	mA		
I <sub>OL(avg)</sub>	Average output “L” current			–	–	5	mA		
f <sub>(XIN)</sub>	XIN clock input oscillation frequency		3.0 V ≤ V <sub>CC</sub> ≤ 5.5 V (other than K version)	0	–	20	MHz		
			3.0 V ≤ V <sub>CC</sub> ≤ 5.5 V (K version)	0	–	16	MHz		
			2.7 V ≤ V <sub>CC</sub> < 3.0 V	0	–	10	MHz		
–	System clock		OCD2 = 0 XIN clock selected	3.0 V ≤ V <sub>CC</sub> ≤ 5.5 V (other than K version)	0	–	20	MHz	
				3.0 V ≤ V <sub>CC</sub> ≤ 5.5 V (K version)	0	–	16	MHz	
				2.7 V ≤ V <sub>CC</sub> < 3.0 V	0	–	10	MHz	
			OCD2 = 1 On-chip oscillator clock selected	FRA01 = 0 Low-speed on-chip oscillator clock selected	–	125	–	–	kHz
				FRA01 = 1 High-speed on-chip oscillator clock selected (other than K version)	–	–	–	20	MHz
				FRA01 = 1 High-speed on-chip oscillator clock selected	–	–	–	10	MHz

**NOTES:**

- V<sub>CC</sub> = 2.7 to 5.5 V at T<sub>opr</sub> = -40 to 85°C (J version) / -40 to 125°C (K version), unless otherwise specified.
- The average output current indicates the average value of current measured during 100 ms.

**Table 5.36 A/D Converter Characteristics**

Symbol	Parameter		Conditions	Standard			Unit
				Min.	Typ.	Max.	
–	Resolution		$V_{ref} = AV_{CC}$	–	–	10	Bits
–	Absolute accuracy	10-bit mode	$\phi_{AD} = 10 \text{ MHz}, V_{ref} = AV_{CC} = 5.0 \text{ V}$	–	–	$\pm 3$	LSB
		8-bit mode	$\phi_{AD} = 10 \text{ MHz}, V_{ref} = AV_{CC} = 5.0 \text{ V}$	–	–	$\pm 2$	LSB
		10-bit mode	$\phi_{AD} = 10 \text{ MHz}, V_{ref} = AV_{CC} = 3.3 \text{ V}$	–	–	$\pm 5$	LSB
		8-bit mode	$\phi_{AD} = 10 \text{ MHz}, V_{ref} = AV_{CC} = 3.3 \text{ V}$	–	–	$\pm 2$	LSB
$R_{ladder}$	Resistor ladder		$V_{ref} = AV_{CC}$	10	–	40	$k\Omega$
$t_{conv}$	Conversion time	10-bit mode	$\phi_{AD} = 10 \text{ MHz}, V_{ref} = AV_{CC} = 5.0 \text{ V}$	3.3	–	–	$\mu\text{s}$
		8-bit mode	$\phi_{AD} = 10 \text{ MHz}, V_{ref} = AV_{CC} = 5.0 \text{ V}$	2.8	–	–	$\mu\text{s}$
$V_{ref}$	Reference voltage			2.7	–	$AV_{CC}$	V
$V_{IA}$	Analog input voltage <sup>(2)</sup>			0	–	$AV_{CC}$	V
–	A/D operating clock frequency	Without sample and hold		0.25	–	10	MHz
		With sample and hold		1	–	10	MHz

**NOTES:**

- $AV_{CC} = 2.7$  to  $5.5 \text{ V}$  at  $T_{opr} = -40$  to  $85^\circ\text{C}$  (J version) /  $-40$  to  $125^\circ\text{C}$  (K version), unless otherwise specified.
- When the analog input voltage is over the reference voltage, the A/D conversion result will be 3FFh in 10-bit mode and FFh in 8-bit mode.

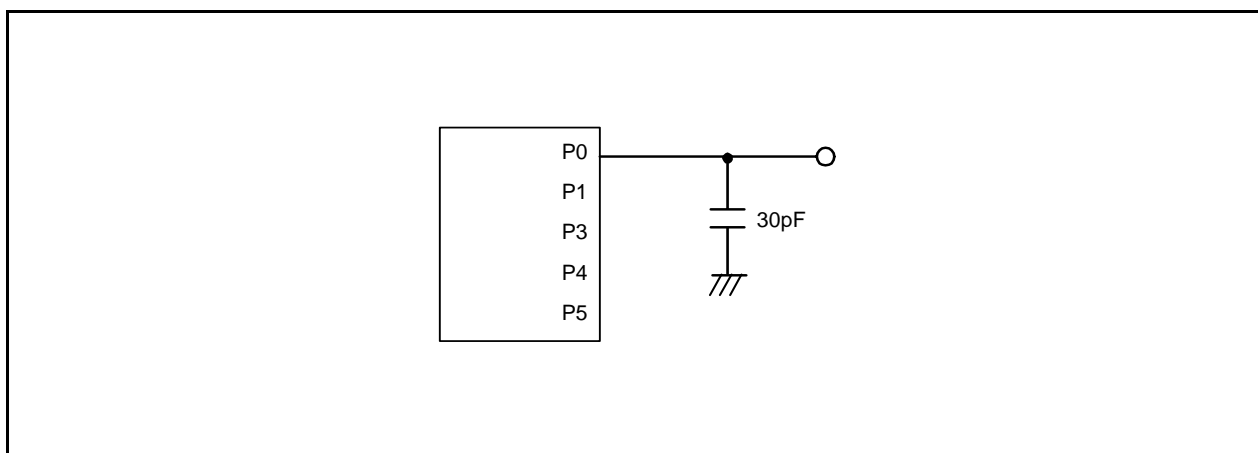
**Figure 5.20 Ports P0, P1, and P3 to P5 Timing Measurement Circuit**

**Table 5.37 Flash Memory (Program ROM) Electrical Characteristics**

Symbol	Parameter	Conditions	Standard			Unit
			Min.	Typ.	Max.	
–	Program/erase endurance <sup>(2)</sup>	R8C/26 Group	100 <sup>(3)</sup>	–	–	times
		R8C/27 Group	1,000 <sup>(3)</sup>	–	–	times
–	Byte program time		–	50	400	μs
–	Block erase time		–	0.4	9	s
t <sub>d</sub> (SR-SUS)	Time delay from suspend request until suspend		–	–	97 + CPU clock x 6 cycles	μs
–	Interval from erase start/restart until following suspend request		650	–	–	μs
–	Interval from program start/restart until following suspend request		0	–	–	ns
–	Time from suspend until program/erase restart		–	–	3 + CPU clock x 4 cycles	μs
–	Program, erase voltage		2.7	–	5.5	V
–	Read voltage		2.7	–	5.5	V
–	Program, erase temperature		0	–	60	°C
–	Data hold time <sup>(7)</sup>	Ambient temperature = 55°C	20	–	–	year

**NOTES:**

- V<sub>CC</sub> = 2.7 to 5.5 V at T<sub>opr</sub> = 0 to 60°C, unless otherwise specified.
- Definition of programming/erasure endurance  
The programming and erasure endurance is defined on a per-block basis.  
If the programming and erasure endurance is n (n = 100 or 1,000), each block can be erased n times. For example, if 1,024 1-byte writes are performed to different addresses in block A, a 1 Kbyte block, and then the block is erased, the programming/erasure endurance still stands at one.  
However, the same address must not be programmed more than once per erase operation (overwriting prohibited).
- Endurance to guarantee all electrical characteristics after program and erase. (1 to Min. value can be guaranteed).
- In a system that executes multiple programming operations, the actual erasure count can be reduced by writing to sequential addresses in turn so that as much of the block as possible is used up before performing an erase operation. For example, when programming groups of 16 bytes, the effective number of rewrites can be minimized by programming up to 128 groups before erasing them all in one operation. It is also advisable to retain data on the erasure endurance of each block and limit the number of erase operations to a certain number.
- If an error occurs during block erase, attempt to execute the clear status register command, then execute the block erase command at least three times until the erase error does not occur.
- Customers desiring program/erase failure rate information should contact their Renesas technical support representative.
- The data hold time includes time that the power supply is off or the clock is not supplied.

**Table 5.38 Flash Memory (Data flash Block A, Block B) Electrical Characteristics<sup>(4)</sup>**

Symbol	Parameter	Conditions	Standard			Unit
			Min.	Typ.	Max.	
–	Program/erase endurance <sup>(2)</sup>		10,000 <sup>(3)</sup>	–	–	times
–	Byte program time (program/erase endurance ≤ 1,000 times)		–	50	400	μs
–	Byte program time (program/erase endurance > 1,000 times)		–	65	–	μs
–	Block erase time (program/erase endurance ≤ 1,000 times)		–	0.2	9	s
–	Block erase time (program/erase endurance > 1,000 times)		–	0.3	–	s
t <sub>d(SR-SUS)</sub>	Time delay from suspend request until suspend		–	–	97 + CPU clock × 6 cycles	μs
–	Interval from erase start/restart until following suspend request		650	–	–	μs
–	Interval from program start/restart until following suspend request		0	–	–	ns
–	Time from suspend until program/erase restart		–	–	3 + CPU clock × 4 cycles	μs
–	Program, erase voltage		2.7	–	5.5	V
–	Read voltage		2.7	–	5.5	V
–	Program, erase temperature		-40	–	85 <sup>(8)</sup>	°C
–	Data hold time <sup>(9)</sup>	Ambient temperature = 55°C	20	–	–	year

**NOTES:**

- V<sub>CC</sub> = 2.7 to 5.5 V at T<sub>opr</sub> = -40 to 85°C (J version) / -40 to 125°C (K version), unless otherwise specified.
- Definition of programming/erasure endurance  
The programming and erasure endurance is defined on a per-block basis.  
If the programming and erasure endurance is n (n = 10,000), each block can be erased n times. For example, if 1,024 1-byte writes are performed to different addresses in block A, a 1 Kbyte block, and then the block is erased, the programming/erasure endurance still stands at one.  
However, the same address must not be programmed more than once per erase operation (overwriting prohibited).
- Endurance to guarantee all electrical characteristics after program and erase. (1 to Min. value can be guaranteed).
- Standard of block A and block B when program and erase endurance exceeds 1,000 times. Byte program time to 1,000 times is the same as that in program ROM.
- In a system that executes multiple programming operations, the actual erasure count can be reduced by writing to sequential addresses in turn so that as much of the block as possible is used up before performing an erase operation. For example, when programming groups of 16 bytes, the effective number of rewrites can be minimized by programming up to 128 groups before erasing them all in one operation. In addition, averaging the erasure endurance between blocks A and B can further reduce the actual erasure endurance. It is also advisable to retain data on the erasure endurance of each block and limit the number of erase operations to a certain number.
- If an error occurs during block erase, attempt to execute the clear status register command, then execute the block erase command at least three times until the erase error does not occur.
- Customers desiring program/erase failure rate information should contact their Renesas technical support representative.
- 125°C for K version.
- The data hold time includes time that the power supply is off or the clock is not supplied.

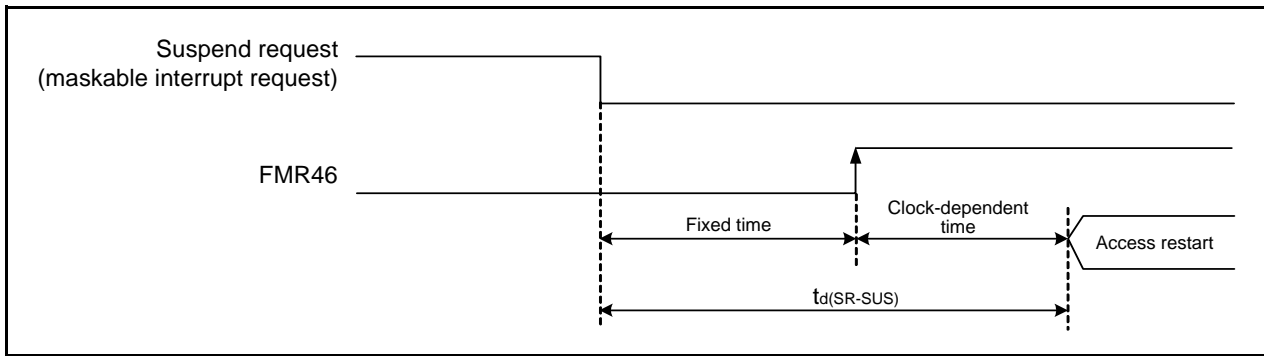

Figure 5.21 Time delay until Suspend

Table 5.39 Voltage Detection 1 Circuit Electrical Characteristics

Symbol	Parameter	Condition	Standard			Unit
			Min.	Typ.	Max.	
V <sub>det1</sub>	Voltage detection level <sup>(2, 4)</sup>		2.70	2.85	3.0	V
t <sub>d</sub> (V <sub>det1</sub> -A)	Voltage monitor 1 reset generation time <sup>(5)</sup>		–	40	200	μs
–	Voltage detection circuit self power consumption	VCA26 = 1, V <sub>CC</sub> = 5.0 V	–	0.6	–	μA
t <sub>d</sub> (E-A)	Waiting time until voltage detection circuit operation starts <sup>(3)</sup>		–	–	100	μs
V <sub>ccmin</sub>	MCU operating voltage minimum value		2.70	–	–	V

## NOTES:

- The measurement condition is V<sub>CC</sub> = 2.7 to 5.5 V and T<sub>opr</sub> = -40 to 85°C (J version) / -40 to 125°C (K version).
- Hold V<sub>det2</sub> > V<sub>det1</sub>.
- Necessary time until the voltage detection circuit operates when setting to 1 again after setting the VCA26 bit in the VCA2 register to 0.
- This parameter shows the voltage detection level when the power supply drops.  
The voltage detection level when the power supply rises is higher than the voltage detection level when the power supply drops by approximately 0.1 V.
- Time until the voltage monitor 1 reset is generated after the voltage passes V<sub>det1</sub> when V<sub>CC</sub> falls. When using the digital filter, its sampling time is added to t<sub>d</sub>(V<sub>det1</sub>-A). When using the voltage monitor 1 reset, maintain this time until V<sub>CC</sub> = 2.0 V after the voltage passes V<sub>det1</sub> when the power supply falls.

Table 5.40 Voltage Detection 2 Circuit Electrical Characteristics

Symbol	Parameter	Condition	Standard			Unit
			Min.	Typ.	Max.	
V <sub>det2</sub>	Voltage detection level <sup>(2)</sup>		3.3	3.6	3.9	V
t <sub>d</sub> (V <sub>det2</sub> -A)	Voltage monitor 2 reset/interrupt request generation time <sup>(3, 5)</sup>		–	40	200	μs
–	Voltage detection circuit self power consumption	VCA27 = 1, V <sub>CC</sub> = 5.0 V	–	0.6	–	μA
t <sub>d</sub> (E-A)	Waiting time until voltage detection circuit operation starts <sup>(4)</sup>		–	–	100	μs

## NOTES:

- The measurement condition is V<sub>CC</sub> = 2.7 to 5.5 V and T<sub>opr</sub> = -40 to 85°C (J version) / -40 to 125°C (K version).
- Hold V<sub>det2</sub> > V<sub>det1</sub>.
- Time until the voltage monitor 2 reset/interrupt request is generated after the voltage passes V<sub>det2</sub>.
- Necessary time until the voltage detection circuit operates after setting to 1 again after setting the VCA27 bit in the VCA2 register to 0.
- When using the digital filter, its sampling time is added to t<sub>d</sub>(V<sub>det2</sub>-A). When using the voltage monitor 2 reset, maintain this time until V<sub>CC</sub> = 2.0 V after the voltage passes V<sub>det2</sub> when the power supply falls.

**Table 5.41 Power-on Reset Circuit, Voltage Monitor 1 Reset Electrical Characteristics<sup>(3)</sup>**

Symbol	Parameter	Condition	Standard			Unit
			Min.	Typ.	Max.	
$V_{por1}$	Power-on reset valid voltage <sup>(4)</sup>		–	–	0.1	V
$V_{por2}$	Power-on reset or voltage monitor 1 reset valid voltage		0	–	$V_{det1}$	V
$t_{rth}$	External power $V_{cc}$ rise gradient	$V_{cc} \leq 3.6$ V	20 <sup>(2)</sup>	–	–	mV/msec
		$V_{cc} > 3.6$ V	20 <sup>(2)</sup>	–	2,000	mV/msec

**NOTES:**

- The measurement condition is  $T_{opr} = -40$  to  $85^{\circ}\text{C}$  (J version) /  $-40$  to  $125^{\circ}\text{C}$  (K version), unless otherwise specified.
- This condition (the minimum value of external power  $V_{cc}$  rise gradient) does not apply if  $V_{por2} \geq 1.0$  V.
- To use the power-on reset function, enable voltage monitor 1 reset by setting the LVD1ON bit in the OFS register to 0, the VW1C0 and VW1C6 bits in the VW1C register to 1 respectively, and the VCA26 bit in the VCA2 register to 1.
- $t_{w(por1)}$  indicates the duration the external power  $V_{cc}$  must be held below the effective voltage ( $V_{por1}$ ) to enable a power on reset. When turning on the power for the first time, maintain  $t_{w(por1)}$  for 30 s or more if  $-20^{\circ}\text{C} \leq T_{opr} \leq 125^{\circ}\text{C}$ , maintain  $t_{w(por1)}$  for 3,000 s or more if  $-40^{\circ}\text{C} \leq T_{opr} < -20^{\circ}\text{C}$ .

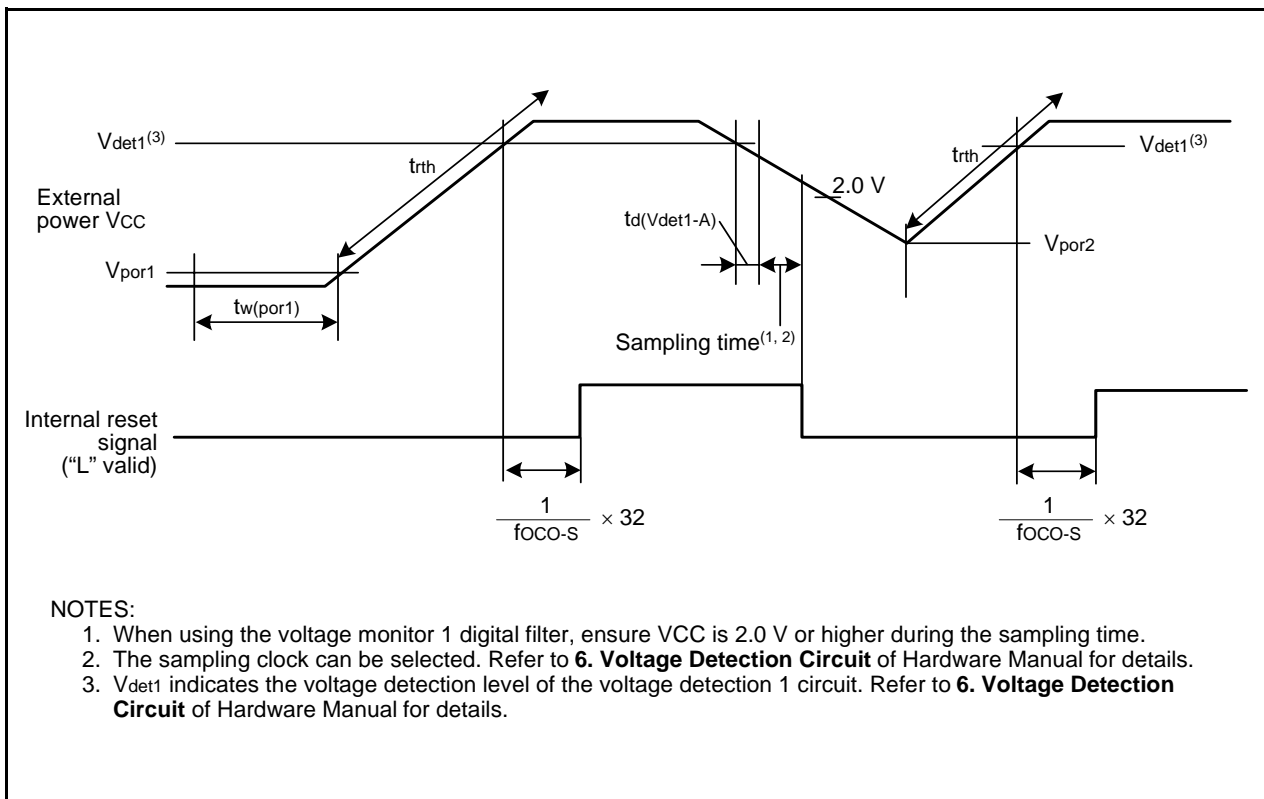
**Figure 5.22 Reset Circuit Electrical Characteristics**



**Table 5.42 High-speed On-Chip Oscillator Circuit Electrical Characteristics**

Symbol	Parameter	Condition	Standard			Unit
			Min.	Typ.	Max.	
fOCO40M	High-speed on-chip oscillator frequency temperature · supply voltage dependence	V <sub>CC</sub> = 4.75 to 5.25 V 0°C ≤ T <sub>opr</sub> ≤ 60°C <sup>(2)</sup>	39.2	40	40.8	MHz
		V <sub>CC</sub> = 3.0 to 5.5 V -20°C ≤ T <sub>opr</sub> ≤ 85°C <sup>(2)</sup>	38.8	40	41.2	MHz
		V <sub>CC</sub> = 3.0 to 5.5 V -40°C ≤ T <sub>opr</sub> ≤ 85°C <sup>(2)</sup>	38.4	40	41.6	MHz
		V <sub>CC</sub> = 3.0 to 5.5 V -40°C ≤ T <sub>opr</sub> ≤ 125°C <sup>(2)</sup>	38	40	42	MHz
		V <sub>CC</sub> = 2.7 to 5.5 V -40°C ≤ T <sub>opr</sub> ≤ 125°C <sup>(2)</sup>	37.6	40	42.4	MHz
–	Value in FRA1 register after reset		08h	–	F7h	–
–	Oscillation frequency adjustment unit of high-speed on-chip oscillator	Adjust FRA1 register (value after reset) to -1	–	+0.3	–	MHz
–	Oscillation stability time		–	10	100	μs
–	Self power consumption at oscillation	V <sub>CC</sub> = 5.0 V, T <sub>opr</sub> = 25°C	–	400	–	μA

## NOTES:

- V<sub>CC</sub> = 2.7 to 5.5 V, T<sub>opr</sub> = -40 to 85°C (J version) / -40 to 125°C (K version), unless otherwise specified.
- These standard values show when the FRA1 register value after reset is assumed.

**Table 5.43 Low-speed On-Chip Oscillator Circuit Electrical Characteristics**

Symbol	Parameter	Condition	Standard			Unit
			Min.	Typ.	Max.	
fOCO-S	Low-speed on-chip oscillator frequency		40	125	250	kHz
–	Oscillation stability time		–	10	100	μs
–	Self power consumption at oscillation	V <sub>CC</sub> = 5.0 V, T <sub>opr</sub> = 25°C	–	15	–	μA

## NOTE:

- V<sub>CC</sub> = 2.7 to 5.5 V, T<sub>opr</sub> = -40 to 85°C (J version) / -40 to 125°C (K version), unless otherwise specified.

**Table 5.44 Power Supply Circuit Timing Characteristics**

Symbol	Parameter	Condition	Standard			Unit
			Min.	Typ.	Max.	
t <sub>d</sub> (P-R)	Time for internal power supply stabilization during power-on <sup>(2)</sup>		1	–	2000	μs
t <sub>d</sub> (R-S)	STOP exit time <sup>(3)</sup>		–	–	150	μs

## NOTES:

- The measurement condition is V<sub>CC</sub> = 2.7 to 5.5 V and T<sub>opr</sub> = 25°C.
- Waiting time until the internal power supply generation circuit stabilizes during power-on.
- Time until system clock supply starts after the interrupt is acknowledged to exit stop mode.

**Table 5.45 Timing Requirements of Clock Synchronous Serial I/O with Chip Select<sup>(1)</sup>**

Symbol	Parameter		Conditions	Standard			Unit
				Min.	Typ.	Max.	
tsucyc	SSCK clock cycle time			4	–	–	tcyc <sup>(2)</sup>
tHI	SSCK clock "H" width			0.4	–	0.6	tsucyc
tLO	SSCK clock "L" width			0.4	–	0.6	tsucyc
tRISE	SSCK clock rising time	Master		–	–	1	tcyc <sup>(2)</sup>
		Slave		–	–	1	μs
tFALL	SSCK clock falling time	Master		–	–	1	tcyc <sup>(2)</sup>
		Slave		–	–	1	μs
tsu	SSO, SSI data input setup time			100	–	–	ns
tH	SSO, SSI data input hold time			1	–	–	tcyc <sup>(2)</sup>
tLEAD	$\overline{\text{SCS}}$ setup time	Slave		1tcyc + 50	–	–	ns
tLAG	$\overline{\text{SCS}}$ hold time	Slave		1tcyc + 50	–	–	ns
tOD	SSO, SSI data output delay time			–	–	1	tcyc <sup>(2)</sup>
tSA	SSI slave access time			–	–	1.5tcyc + 100	ns
tOR	SSI slave out open time			–	–	1.5tcyc + 100	ns

## NOTES:

1.  $V_{CC} = 2.7$  to  $5.5$  V,  $V_{SS} = 0$  V at  $T_{opr} = -40$  to  $85^{\circ}\text{C}$  (J version) /  $-40$  to  $125^{\circ}\text{C}$  (K version), unless otherwise specified.
2.  $1tcyc = 1/f_1(\text{s})$

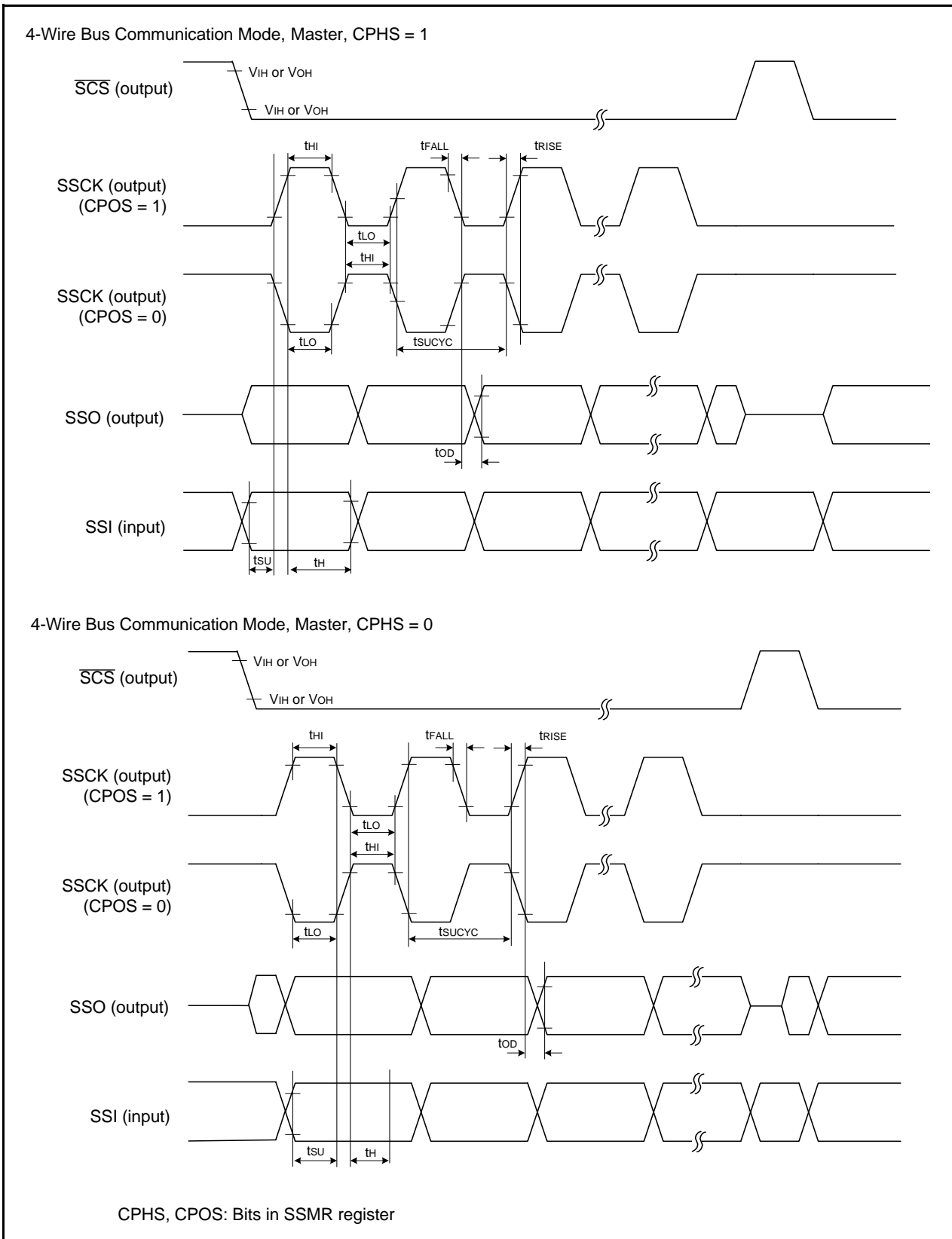

Figure 5.23 I/O Timing of Clock Synchronous Serial I/O with Chip Select (Master)

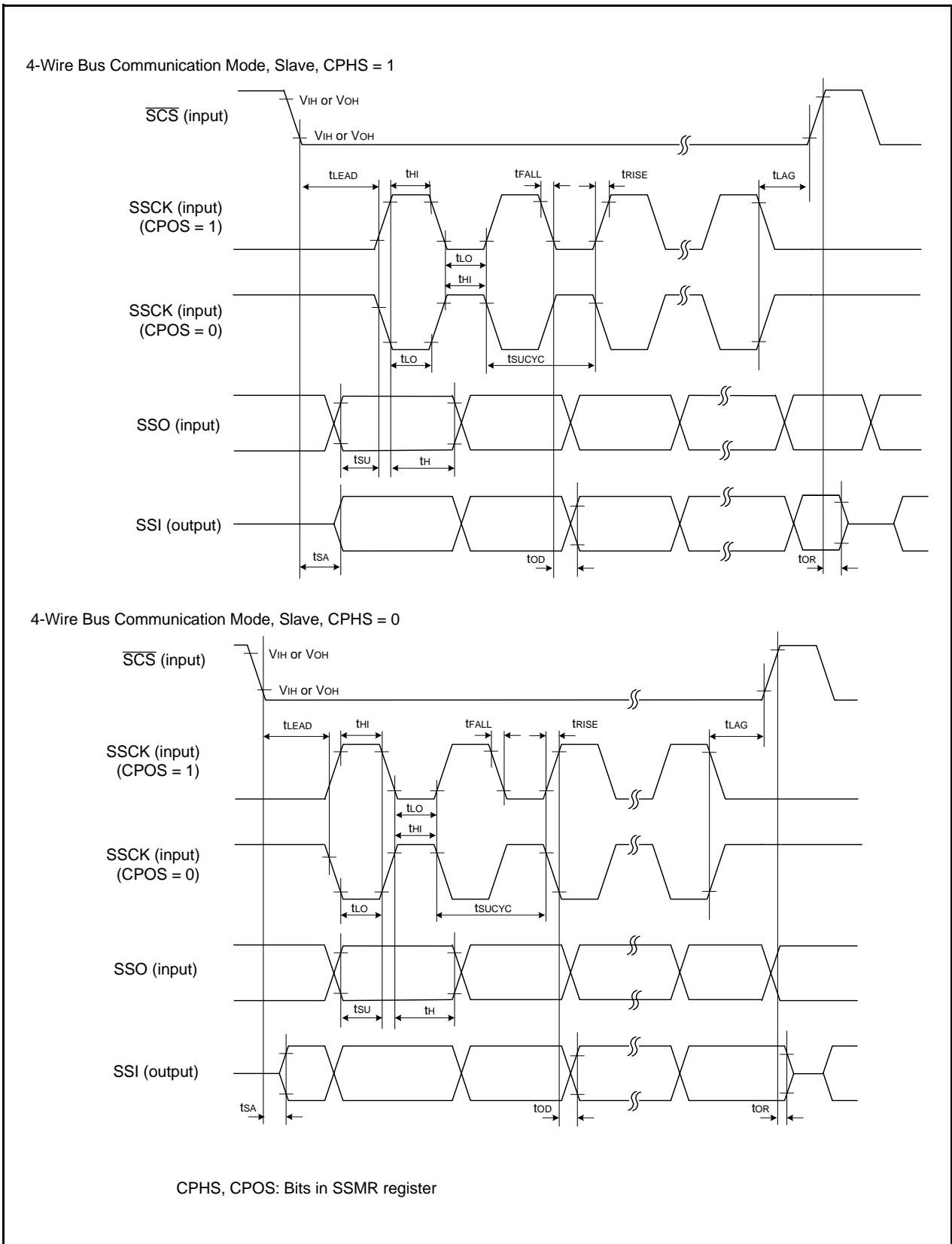
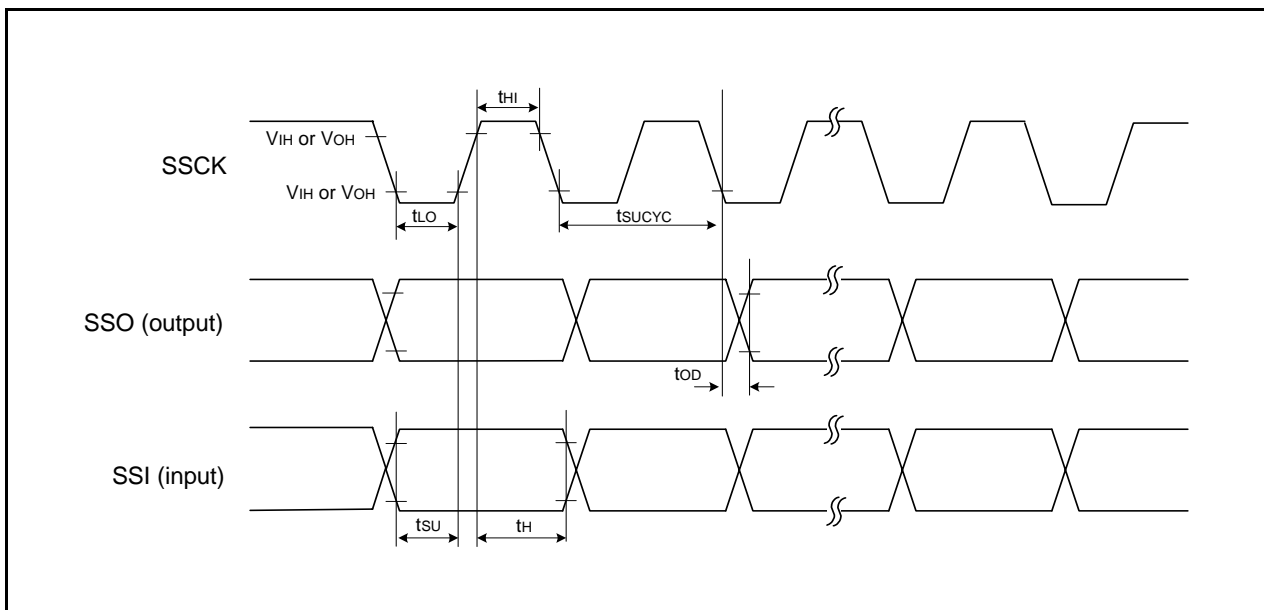

Figure 5.24 I/O Timing of Clock Synchronous Serial I/O with Chip Select (Slave)



**Figure 5.25 I/O Timing of Clock Synchronous Serial I/O with Chip Select (Clock Synchronous Communication Mode)**

**Table 5.46 Timing Requirements of I<sup>2</sup>C bus Interface(1)**

Symbol	Parameter	Condition	Standard			Unit
			Min.	Typ.	Max.	
t <sub>SCL</sub>	SCL input cycle time		12t <sub>CYC</sub> + 600 <sup>(2)</sup>	–	–	ns
t <sub>SCLH</sub>	SCL input “H” width		3t <sub>CYC</sub> + 300 <sup>(2)</sup>	–	–	ns
t <sub>SCLL</sub>	SCL input “L” width		5t <sub>CYC</sub> + 500 <sup>(2)</sup>	–	–	ns
t <sub>sf</sub>	SCL, SDA input fall time		–	–	300	ns
t <sub>SP</sub>	SCL, SDA input spike pulse rejection time		–	–	1t <sub>CYC</sub> <sup>(2)</sup>	ns
t <sub>BUF</sub>	SDA input bus-free time		5t <sub>CYC</sub> <sup>(2)</sup>	–	–	ns
t <sub>STAH</sub>	Start condition input hold time		3t <sub>CYC</sub> <sup>(2)</sup>	–	–	ns
t <sub>STAS</sub>	Retransmit start condition input setup time		3t <sub>CYC</sub> <sup>(2)</sup>	–	–	ns
t <sub>STOP</sub>	Stop condition input setup time		3t <sub>CYC</sub> <sup>(2)</sup>	–	–	ns
t <sub>SDAS</sub>	Data input setup time		1t <sub>CYC</sub> + 20 <sup>(2)</sup>	–	–	ns
t <sub>SDAH</sub>	Data input hold time		0	–	–	ns

NOTES:

1. V<sub>CC</sub> = 2.7 to 5.5 V, V<sub>SS</sub> = 0 V at T<sub>opr</sub> = -40 to 85°C (J version) / -40 to 125°C (K version), unless otherwise specified.
2. 1t<sub>CYC</sub> = 1/f<sub>1</sub>(s)

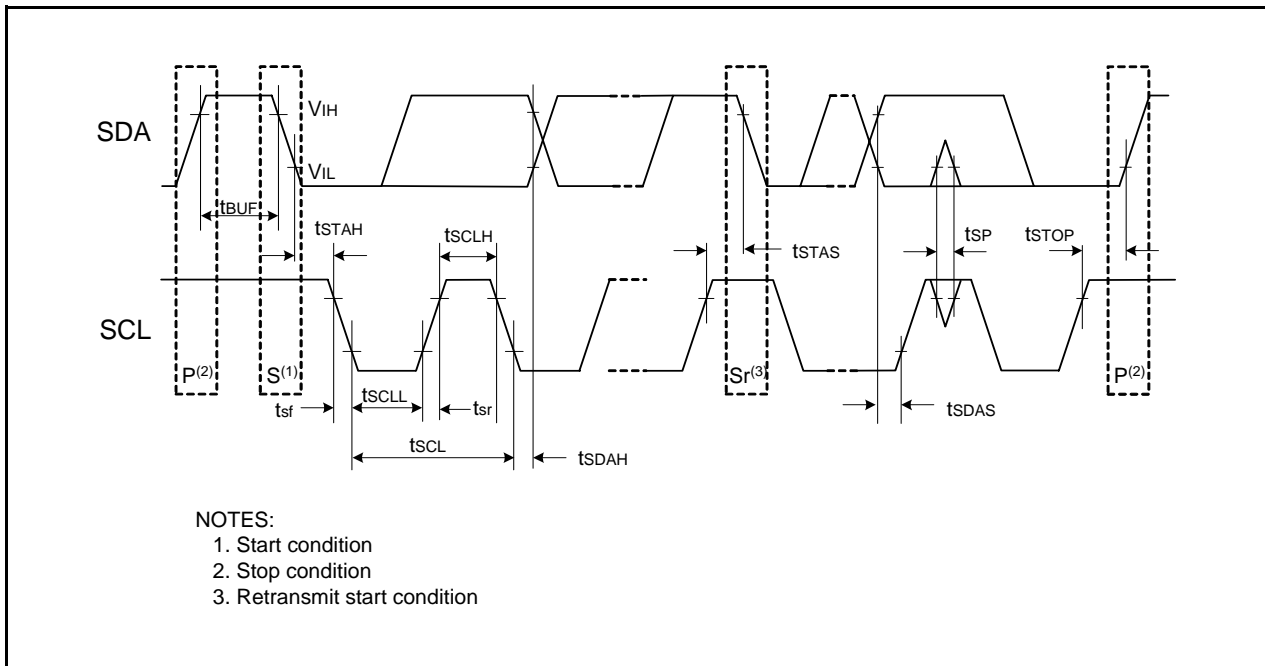

**Figure 5.26 I/O Timing of I<sup>2</sup>C bus Interface**

**Table 5.47 Electrical Characteristics (1) [V<sub>CC</sub> = 5 V]**

Symbol	Parameter		Condition	Standard			Unit	
				Min.	Typ.	Max.		
V <sub>OH</sub>	Output "H" voltage	Except XOUT	I <sub>OH</sub> = -5 mA		V <sub>CC</sub> - 2.0	–	V <sub>CC</sub>	V
			I <sub>OH</sub> = -200 μA		V <sub>CC</sub> - 0.3	–	V <sub>CC</sub>	V
	XOUT		Drive capacity HIGH	I <sub>OH</sub> = -1 mA	V <sub>CC</sub> - 2.0	–	V <sub>CC</sub>	V
			Drive capacity LOW	I <sub>OH</sub> = -500 μA	V <sub>CC</sub> - 2.0	–	V <sub>CC</sub>	V
V <sub>OL</sub>	Output "L" voltage	Except XOUT	I <sub>OL</sub> = 5 mA		–	–	2.0	V
			I <sub>OL</sub> = 200 μA		–	–	0.45	V
	XOUT		Drive capacity HIGH	I <sub>OL</sub> = 1 mA	–	–	2.0	V
			Drive capacity LOW	I <sub>OL</sub> = 500 μA	–	–	2.0	V
V <sub>T+</sub> -V <sub>T-</sub>	Hysteresis	INT0, INT1, INT3, K10, K11, K12, K13, TRAIO, RXD0, RXD1, CLK0, CLK1, SSI, SCL, SDA, SSO			0.1	0.5	–	V
		RESET			0.1	1.0	–	V
I <sub>IH</sub>	Input "H" current		V <sub>I</sub> = 5 V, V <sub>CC</sub> = 5V		–	–	5.0	μA
I <sub>IL</sub>	Input "L" current		V <sub>I</sub> = 0 V, V <sub>CC</sub> = 5V		–	–	-5.0	μA
R <sub>PULLUP</sub>	Pull-up resistance		V <sub>I</sub> = 0 V, V <sub>CC</sub> = 5V		30	50	167	kΩ
R <sub>fXIN</sub>	Feedback resistance	XIN			–	1.0	–	MΩ
V <sub>RAM</sub>	RAM hold voltage		During stop mode		2.0	–	–	V

## NOTE:

1. V<sub>CC</sub> = 4.2 to 5.5 V at T<sub>opr</sub> = -40 to 85°C (J version) / -40 to 125°C (K version), f(XIN) = 20 MHz, unless otherwise specified.

**Table 5.48 Electrical Characteristics (2) [V<sub>CC</sub> = 5 V]  
(T<sub>opr</sub> = -40 to 85°C (J version) / -40 to 125°C (K version), unless otherwise specified.)**

Symbol	Parameter	Condition	Standard			Unit	
			Min.	Typ.	Max.		
I <sub>CC</sub>	Power supply current (V <sub>CC</sub> = 3.3 to 5.5 V) Single-chip mode, output pins are open, other pins are V <sub>SS</sub>	High-speed clock mode	XIN = 20 MHz (square wave) High-speed on-chip oscillator off Low-speed on-chip oscillator on = 125 kHz No division	–	10	17	mA
			XIN = 16 MHz (square wave) High-speed on-chip oscillator off Low-speed on-chip oscillator on = 125 kHz No division	–	9	15	mA
			XIN = 10 MHz (square wave) High-speed on-chip oscillator off Low-speed on-chip oscillator on = 125 kHz No division	–	6	–	mA
			XIN = 20 MHz (square wave) High-speed on-chip oscillator off Low-speed on-chip oscillator on = 125 kHz Divide-by-8	–	5	–	mA
			XIN = 16 MHz (square wave) High-speed on-chip oscillator off Low-speed on-chip oscillator on = 125 kHz Divide-by-8	–	4	–	mA
			XIN = 10 MHz (square wave) High-speed on-chip oscillator off Low-speed on-chip oscillator on = 125 kHz Divide-by-8	–	2.5	–	mA
		High-speed on-chip oscillator mode	XIN clock off High-speed on-chip oscillator on f <sub>OCO</sub> = 20 MHz (J version) Low-speed on-chip oscillator on = 125 kHz No division	–	10	15	mA
			XIN clock off High-speed on-chip oscillator on f <sub>OCO</sub> = 20 MHz (J version) Low-speed on-chip oscillator on = 125 kHz Divide-by-8	–	4	–	mA
			XIN clock off High-speed on-chip oscillator on f <sub>OCO</sub> = 10 MHz Low-speed on-chip oscillator on = 125 kHz No division	–	5.5	10	mA
			XIN clock off High-speed on-chip oscillator on f <sub>OCO</sub> = 10 MHz Low-speed on-chip oscillator on = 125 kHz Divide-by-8	–	2.5	–	mA
		Low-speed on-chip oscillator mode	XIN clock off High-speed on-chip oscillator off Low-speed on-chip oscillator on = 125 kHz Divide-by-8, FMR47 = 1	–	130	300	μA
		Wait mode	XIN clock off High-speed on-chip oscillator off Low-speed on-chip oscillator on = 125 kHz While a WAIT instruction is executed Peripheral clock operation VCA27 = VCA26 = VCA25 = 0 VCA20 = 1	–	25	75	μA
			XIN clock off High-speed on-chip oscillator off Low-speed on-chip oscillator on = 125 kHz While a WAIT instruction is executed Peripheral clock off VCA27 = VCA26 = VCA25 = 0 VCA20 = 1	–	23	60	μA
		Stop mode	XIN clock off, T <sub>opr</sub> = 25°C High-speed on-chip oscillator off Low-speed on-chip oscillator off CM10 = 1 Peripheral clock off VCA27 = VCA26 = VCA25 = 0	–	0.8	3.0	μA
			XIN clock off, T <sub>opr</sub> = 85°C High-speed on-chip oscillator off Low-speed on-chip oscillator off CM10 = 1 Peripheral clock off VCA27 = VCA26 = VCA25 = 0	–	1.2	–	μA
			XIN clock off, T <sub>opr</sub> = 125°C High-speed on-chip oscillator off Low-speed on-chip oscillator off CM10 = 1 Peripheral clock off VCA27 = VCA26 = VCA25 = 0	–	4.0	–	μA



**Timing Requirements****(Unless Otherwise Specified:  $V_{CC} = 5\text{ V}$ ,  $V_{SS} = 0\text{ V}$  at  $T_{opr} = 25^\circ\text{C}$ ) [ $V_{CC} = 5\text{ V}$ ]****Table 5.49 XIN Input**

Symbol	Parameter	Standard		Unit
		Min.	Max.	
$t_{c(XIN)}$	XIN input cycle time	50	–	ns
$t_{WH(XIN)}$	XIN input "H" width	25	–	ns
$t_{WL(XIN)}$	XIN input "L" width	25	–	ns

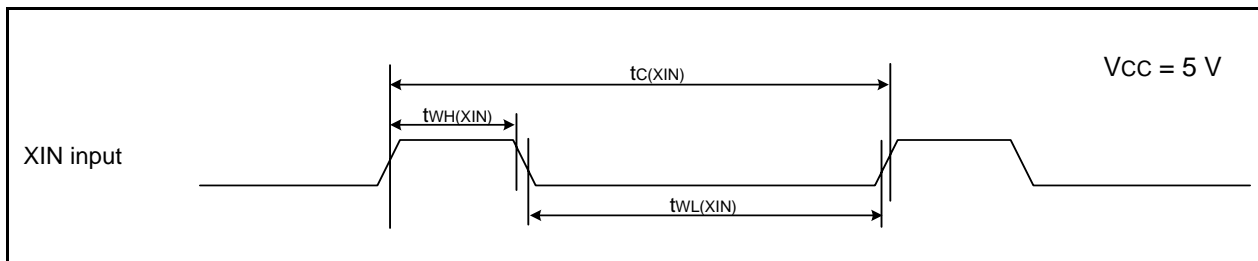
**Figure 5.27 XIN Input Timing Diagram when  $V_{CC} = 5\text{ V}$** **Table 5.50 TRAIO Input**

Symbol	Parameter	Standard		Unit
		Min.	Max.	
$t_{c(TRAIO)}$	TRAIO input cycle time	100	–	ns
$t_{WH(TRAIO)}$	TRAIO input "H" width	40	–	ns
$t_{WL(TRAIO)}$	TRAIO input "L" width	40	–	ns

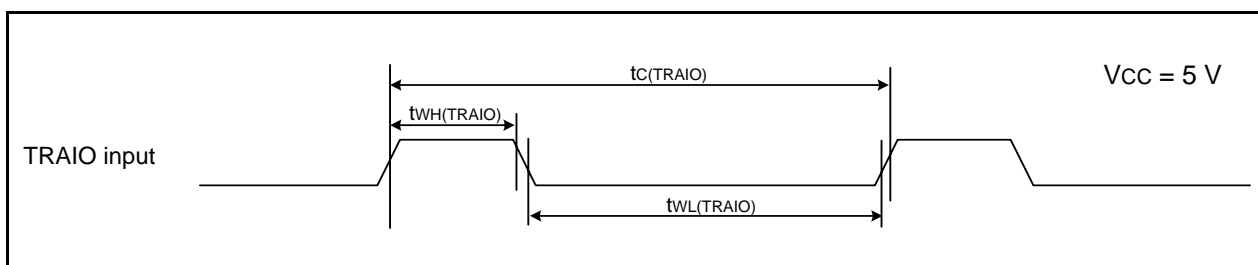
**Figure 5.28 TRAIO Input Timing Diagram when  $V_{CC} = 5\text{ V}$**

**Table 5.51 Serial Interface**

Symbol	Parameter	Standard		Unit
		Min.	Max.	
$t_{c(CK)}$	CLKi input cycle time	200	–	ns
$t_{w(CKH)}$	CLKi input “H” width	100	–	ns
$t_{w(CKL)}$	CLKi input “L” width	100	–	ns
$t_{d(C-Q)}$	TXDi output delay time	–	50	ns
$t_{h(C-Q)}$	TXDi hold time	0	–	ns
$t_{su(D-C)}$	RXDi input setup time	50	–	ns
$t_{h(C-D)}$	RXDi input hold time	90	–	ns

$i = 0$  or  $1$

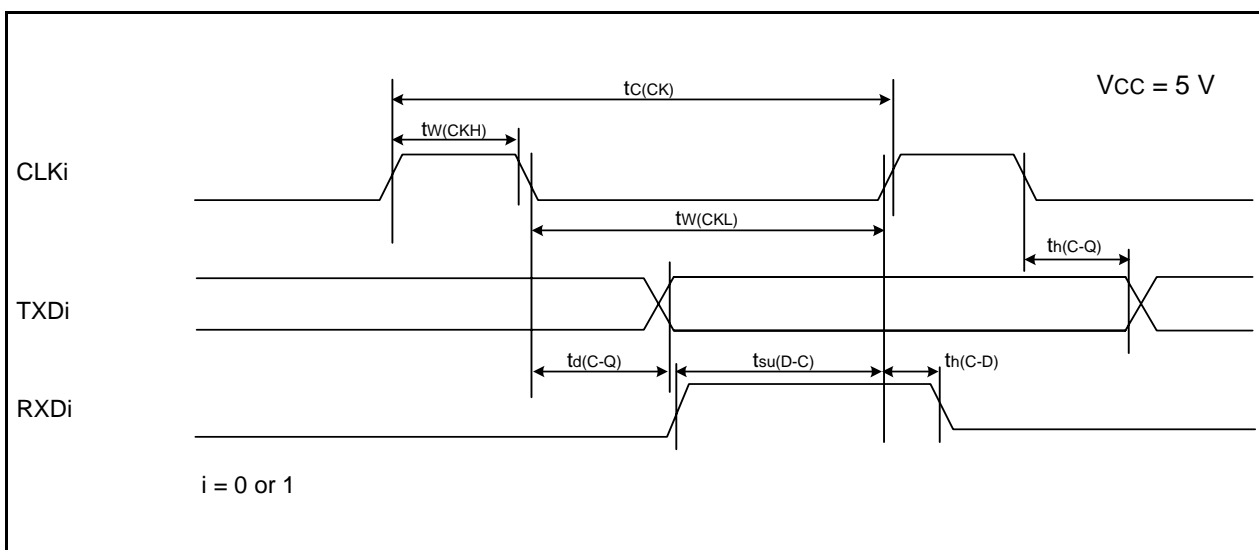

**Figure 5.29 Serial Interface Timing Diagram when Vcc = 5 V**

**Table 5.52 External Interrupt  $\overline{INTi}$  ( $i = 0, 1, 3$ ) Input**

Symbol	Parameter	Standard		Unit
		Min.	Max.	
$t_{w(INH)}$	$\overline{INTi}$ input “H” width	250 <sup>(1)</sup>	–	ns
$t_{w(INL)}$	$\overline{INTi}$ input “L” width	250 <sup>(2)</sup>	–	ns

NOTES:

- When selecting the digital filter by the  $\overline{INTi}$  input filter select bit, use an  $\overline{INTi}$  input HIGH width of either (1/digital filter clock frequency × 3) or the minimum value of standard, whichever is greater.
- When selecting the digital filter by the  $\overline{INTi}$  input filter select bit, use an  $\overline{INTi}$  input LOW width of either (1/digital filter clock frequency × 3) or the minimum value of standard, whichever is greater.

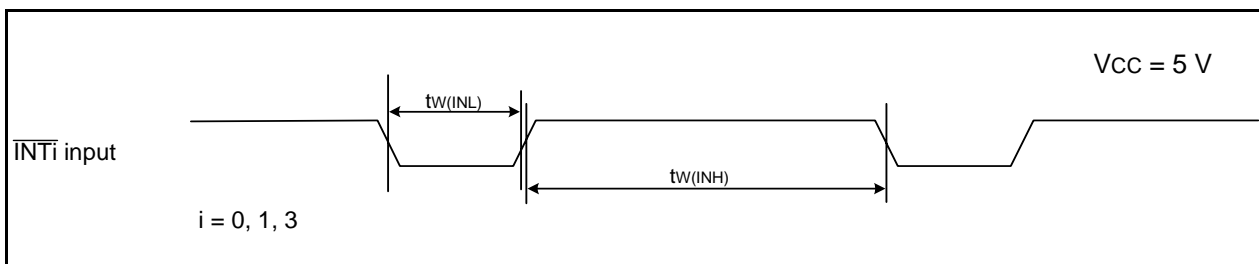

**Figure 5.30 External Interrupt  $\overline{INTi}$  Input Timing Diagram when Vcc = 5 V**

**Table 5.53 Electrical Characteristics (3) [V<sub>CC</sub> = 3 V]**

Symbol	Parameter		Condition		Standard			Unit
					Min.	Typ.	Max.	
V <sub>OH</sub>	Output "H" voltage	Except XOUT	I <sub>OH</sub> = -1 mA		V <sub>CC</sub> - 0.5	–	V <sub>CC</sub>	V
		XOUT	Drive capacity HIGH	I <sub>OH</sub> = -0.1 mA	V <sub>CC</sub> - 0.5	–	V <sub>CC</sub>	V
			Drive capacity LOW	I <sub>OH</sub> = -50 μA	V <sub>CC</sub> - 0.5	–	V <sub>CC</sub>	V
V <sub>OL</sub>	Output "L" voltage	Except XOUT	I <sub>OL</sub> = 1 mA		–	–	0.5	V
		XOUT	Drive capacity HIGH	I <sub>OL</sub> = 0.1 mA	–	–	0.5	V
			Drive capacity LOW	I <sub>OL</sub> = 50 μA	–	–	0.5	V
V <sub>T+</sub> -V <sub>T-</sub>	Hysteresis	$\overline{\text{INT0}}, \overline{\text{INT1}}, \overline{\text{INT3}},$ $\text{K10}, \text{K11}, \text{K12}, \text{K13},$ $\text{TRAIO}, \text{RXD0}, \text{RXD1},$ $\text{CLK0}, \text{CLK1},$ $\text{SSI}, \text{SCL}, \text{SDA}, \text{SSO}$			0.1	0.3	–	V
		$\overline{\text{RESET}}$			0.1	0.4	–	V
I <sub>IH</sub>	Input "H" current		V <sub>I</sub> = 3 V, V <sub>CC</sub> = 3V		–	–	4.0	μA
I <sub>IL</sub>	Input "L" current		V <sub>I</sub> = 0 V, V <sub>CC</sub> = 3V		–	–	-4.0	μA
R <sub>PULLUP</sub>	Pull-up resistance		V <sub>I</sub> = 0 V, V <sub>CC</sub> = 3V		66	160	500	kΩ
R <sub>fXIN</sub>	Feedback resistance	XIN			–	3.0	–	MΩ
V <sub>RAM</sub>	RAM hold voltage		During stop mode		2.0	–	–	V

## NOTE:

- V<sub>CC</sub> = 2.7 to 3.3 V at T<sub>opr</sub> = -40 to 85°C (J version) / -40 to 125°C (K version), f(XIN) = 10 MHz, unless otherwise specified.

**Table 5.54 Electrical Characteristics (4) [V<sub>CC</sub> = 3 V]  
(T<sub>opr</sub> = -40 to 85°C (J version) / -40 to 125°C (K version), unless otherwise specified.)**

Symbol	Parameter	Condition	Standard			Unit	
			Min.	Typ.	Max.		
I <sub>CC</sub>	Power supply current (V <sub>CC</sub> = 2.7 to 3.3 V) Single-chip mode, output pins are open, other pins are V <sub>SS</sub>	High-speed clock mode	XIN = 10 MHz (square wave) High-speed on-chip oscillator off Low-speed on-chip oscillator on = 125 kHz No division	–	6	–	mA
			XIN = 10 MHz (square wave) High-speed on-chip oscillator off Low-speed on-chip oscillator on = 125 kHz Divide-by-8	–	2	–	mA
		High-speed on-chip oscillator mode	XIN clock off High-speed on-chip oscillator on f <sub>OCO</sub> = 10 MHz Low-speed on-chip oscillator on = 125 kHz No division	–	5	9	mA
			XIN clock off High-speed on-chip oscillator on f <sub>OCO</sub> = 10 MHz Low-speed on-chip oscillator on = 125 kHz Divide-by-8	–	2	–	mA
		Low-speed on-chip oscillator mode	XIN clock off High-speed on-chip oscillator off Low-speed on-chip oscillator on = 125 kHz Divide-by-8, FMR47 = 1	–	130	300	μA
		Wait mode	XIN clock off High-speed on-chip oscillator off Low-speed on-chip oscillator on = 125 kHz While a WAIT instruction is executed Peripheral clock operation VCA27 = VCA26 = VCA25 = 0 VCA20 = 1	–	25	70	μA
			XIN clock off High-speed on-chip oscillator off Low-speed on-chip oscillator on = 125 kHz While a WAIT instruction is executed Peripheral clock off VCA27 = VCA26 = VCA25 = 0 VCA20 = 1	–	23	55	μA
		Stop mode	XIN clock off, T <sub>opr</sub> = 25°C High-speed on-chip oscillator off Low-speed on-chip oscillator off CM10 = 1 Peripheral clock off VCA27 = VCA26 = VCA25 = 0	–	0.7	3.0	μA
			XIN clock off, T <sub>opr</sub> = 85°C High-speed on-chip oscillator off Low-speed on-chip oscillator off CM10 = 1 Peripheral clock off VCA27 = VCA26 = VCA25 = 0	–	1.1	–	μA
			XIN clock off, T <sub>opr</sub> = 125°C High-speed on-chip oscillator off Low-speed on-chip oscillator off CM10 = 1 Peripheral clock off VCA27 = VCA26 = VCA25 = 0	–	3.8	–	μA

**Timing requirements****(Unless Otherwise Specified:  $V_{CC} = 3\text{ V}$ ,  $V_{SS} = 0\text{ V}$  at  $T_{opr} = 25^{\circ}\text{C}$ ) [ $V_{CC} = 3\text{ V}$ ]****Table 5.55 XIN Input**

Symbol	Parameter	Standard		Unit
		Min.	Max.	
$t_{c(XIN)}$	XIN input cycle time	100	–	ns
$t_{WH(XIN)}$	XIN input "H" width	40	–	ns
$t_{WL(XIN)}$	XIN input "L" width	40	–	ns

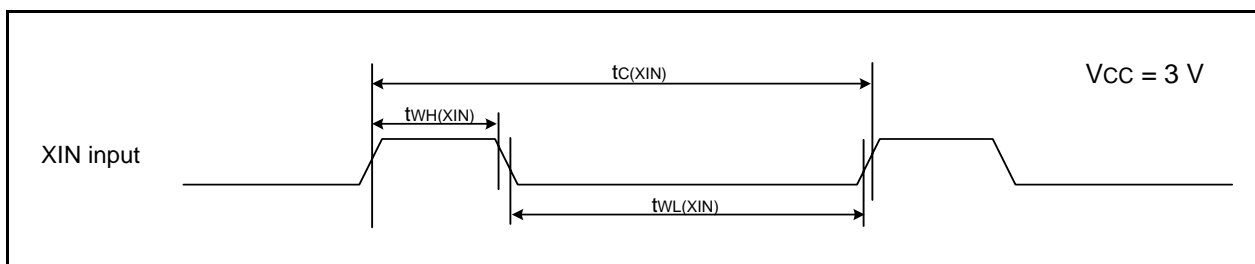
**Figure 5.31 XIN Input Timing Diagram when  $V_{CC} = 3\text{ V}$** **Table 5.56 TRAI0 Input**

Symbol	Parameter	Standard		Unit
		Min.	Max.	
$t_{c(TRAIO)}$	TRAIO input cycle time	300	–	ns
$t_{WH(TRAIO)}$	TRAIO input "H" width	120	–	ns
$t_{WL(TRAIO)}$	TRAIO input "L" width	120	–	ns

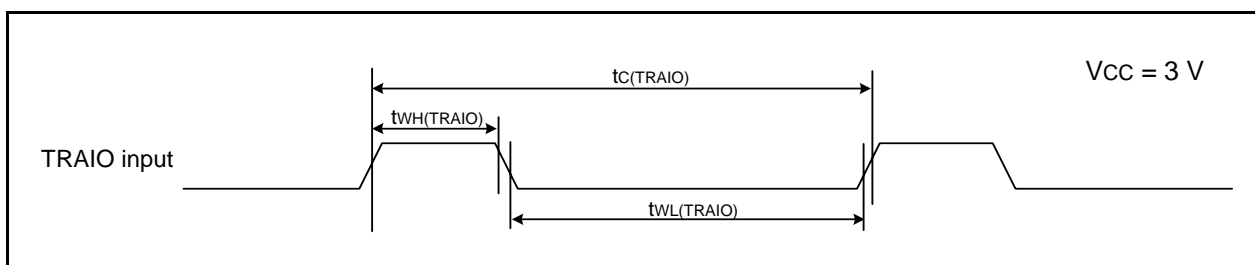
**Figure 5.32 TRAI0 Input Timing Diagram when  $V_{CC} = 3\text{ V}$**

**Table 5.57 Serial Interface**

Symbol	Parameter	Standard		Unit
		Min.	Max.	
$t_{c(CK)}$	CLKi input cycle time	300	–	ns
$t_{w(CKH)}$	CLKi input “H” width	150	–	ns
$t_{w(CKL)}$	CLKi Input “L” width	150	–	ns
$t_{d(C-Q)}$	TXDi output delay time	–	80	ns
$t_{h(C-Q)}$	TXDi hold time	0	–	ns
$t_{su(D-C)}$	RXDi input setup time	70	–	ns
$t_{h(C-D)}$	RXDi input hold time	90	–	ns

$i = 0$  or  $1$

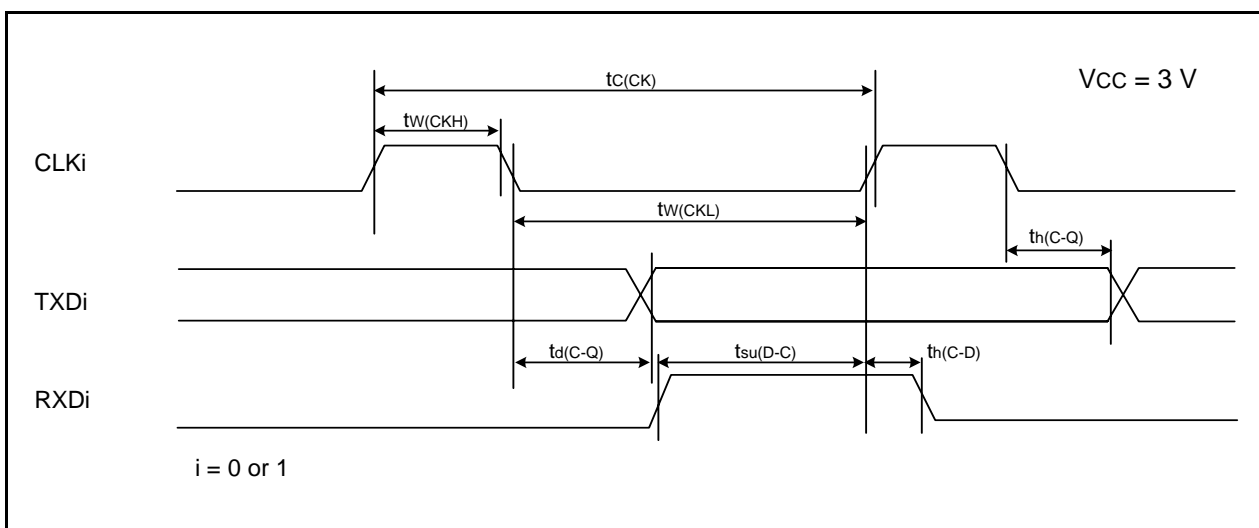

**Figure 5.33 Serial Interface Timing Diagram when Vcc = 3 V**

**Table 5.58 External Interrupt  $\overline{INTi}$  ( $i = 0, 1, 3$ ) Input**

Symbol	Parameter	Standard		Unit
		Min.	Max.	
$t_{w(INH)}$	$\overline{INTi}$ input “H” width	380 <sup>(1)</sup>	–	ns
$t_{w(INL)}$	$\overline{INTi}$ input “L” width	380 <sup>(2)</sup>	–	ns

NOTES:

1. When selecting the digital filter by the  $\overline{INTi}$  input filter select bit, use an  $\overline{INTi}$  input HIGH width of either (1/digital filter clock frequency × 3) or the minimum value of standard, whichever is greater.
2. When selecting the digital filter by the  $\overline{INTi}$  input filter select bit, use an  $\overline{INTi}$  input LOW width of either (1/digital filter clock frequency × 3) or the minimum value of standard, whichever is greater.

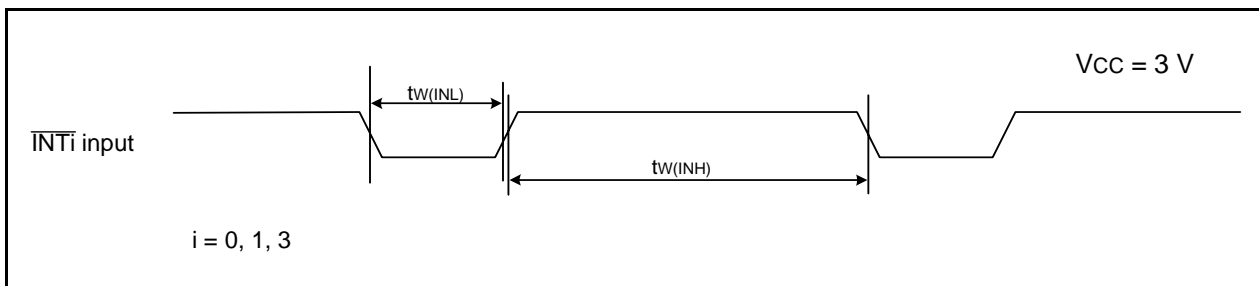

**Figure 5.34 External Interrupt  $\overline{INTi}$  Input Timing Diagram when Vcc = 3 V**

# Package Dimensions

Diagrams showing the latest package dimensions and mounting information are available in the “Packages” section of the Renesas Technology website.

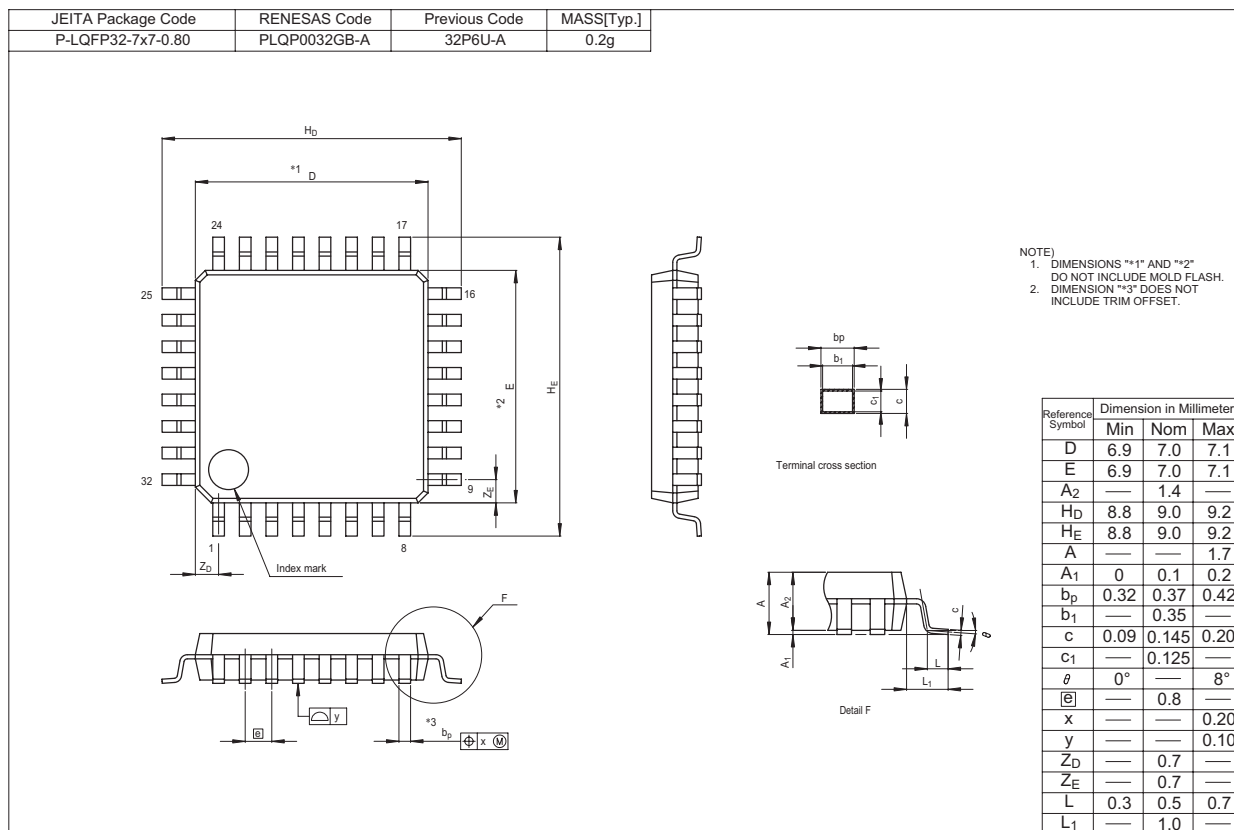

REVISION HISTORY

R8C/26 Group, R8C/27 Group Datasheet

Rev.	Date	Description	
		Page	Summary
0.10	Nov 14, 2005	–	First edition issued
0.20	Feb 06, 2006	2, 3	Table 1.1 Functions and Specifications for R8C/26Group and Table 1.2 Functions and Specifications for R8C/27 Group; Minimum instruction execution time and Supply voltage revised
		9	Table 1.6 Pin Name Information by Pin Number; “XOUT” → “XOUT/XCOUT” and “XIN” → “XIN/XCIN” revised
		18	Table 4.4 SFR Information (4); 00FEh: “DRR” → “P1DRR” revised
		19	Table 4.5 SFR Information (5); -0119h: “Timer RE Minute Data Register / Compare Register” → “Timer RE Minute Data Register / Compare Data Register” -011Ah: “Timer RE Time Data Register” → “Timer RE Hour Data Register” -011Bh: “Timer RE Day Data Register” → “Timer RE Day of Week Data Register” revised
		22 to 45	5. Electrical Characteristics added
1.00	Nov 08, 2006	All pages	“Preliminary” deleted
		2	Table 1.1 revised
		3	Table 1.2 revised
		4	Figure 1.1 revised
		5	Table 1.3 revised
		6	Table 1.4 revised
		7	Figure 1.4 revised
		9	Table 1.6 revised
		15	Table 4.1; • 001Ch: “00h” → “00h, 10000000b” revised • 000Fh: “000XXXXXb” → “00X11111b” revised • 0029h: “High-Speed On-Chip Oscillator Control Register 4, FRA4, When shipping” added • 002Bh: “High-Speed On-Chip Oscillator Control Register 6, FRA6, When shipping” added • 0032h: “00h, 01000000b” → “00h, 00100000b” revised • 0038h: “00001000b, 01001001b” → “0000X000b, 0100X001b” revised • NOTE3 and 4 revised; NOTE6 added
		18	Table 4.4; • 00E0h, 00E1h, 00E5h, 00E8h, 00E9h: “XXh” → “00h” revised • 00FDh: “XX00000000b” → “00h” revised
		22	Table 5.2 revised
		23	Figure 5.1 title revised
		24	Table 5.4 revised
25	Table 5.5 revised		
26	Figure 5.2 title revised and Table 5.7 NOTE4 added		



REVISION HISTORY

R8C/26 Group, R8C/27 Group Datasheet

Rev.	Date	Description	
		Page	Summary
1.00	Nov 08, 2006	27	Table 5.9, Figure 5.3 revised and Table 5.10 deleted
		28	Table 5.10, Table 5.11 revised
		34	Table 5.15 revised
		35	Table 5.16 revised
		36	Table 5.17 revised
		39	Table 5.22 revised
		40	Table 5.23 revised
		44	Table 5.29 revised
		47	Package Dimensions; "Diagrams showing the latest...website." added
1.10	Nov 29, 2006	All pages	"J, K version" added
		1	1 "J and K versions are under development...notice." added 1.1 revised
		2	Table 1.1 revised
		3	Table 1.2 revised
		4	Figure 1.1 NOTE3 added
		5	Table 1.3, Figure 1.2 revised
		6	Table 1.4, Figure 1.3 revised
		7	Figure 1.4 NOTE3 added
		8	Table 1.5 revised
		9	Table 1.6 NOTE2 added
		13	Figure 3.1 revised
		14	Figure 3.2 revised
		15	Table 4.1; "0000h to 003Fh" → "0000h to 002Fh" revised • NOTE3 added
		16	Table 4.2; "0040h to 007Fh" → "0030h to 007Fh" revised • 0032h, 0036h: "After reset" is revised • 0038h: NOTE revised • NOTES 2, 5, 6 revised and NOTE 7, 8 added
		19	Table 4.5 NOTE2 added
28	Table 5.10 revised		
48 to 66	5.2 J, K Version added		
1.20	Jan 17, 2007	18	Table 4.4 NOTE2 added
1.30	May 25, 2007	2	Table 1.1 revised
		3	Table 1.2 revised
		5	Table 1.3 revised
		6	Figure 1.2 revised
		7	Table 1.4 revised
		8	Figure 1.3 revised
		9	Figure 1.4 NOTE4 added
		15	Figure 3.1 part number revised

REVISION HISTORY

R8C/26 Group, R8C/27 Group Datasheet

Rev.	Date	Description	
		Page	Summary
1.30	May 25, 2007	16	Figure 3.2 part number revised
		30	Table 5.10 revised
		53	Table 5.39 NOTE4 added
		55	Table 5.42 revised
1.40a	Jun 14, 2007	5, 7	Table 1.3 and Table 1.4 revised
2.00	Mar 01, 2008	1, 49	1.1, 5.2 "J and K versions are ..." deleted
		5, 7	Table 1.3, Table 1.4 revised
		11	Table 1.6 NOTE3 added
		15, 16	Figure 3.1, Figure 3.2; "Expanded area" deleted
		17	Table 4.1 "002Ch" added
		18	Table 4.2 "0036h"; J, K version "0100X000b" → "0100X001b"
		24, 49	Table 5.2, Table 5.35; NOTE2 revised
30	Table 5.10 revised, NOTE4 added		
2.10	Sep 26, 2008	–	"RENESAS TECHNICAL UP DATE" reflected: TN-16C-A172A/E
		26, 51	Table 5.4, Table 5.37 NOTE2, NOTE4 revised
		27, 52	Table 5.5, Table 5.38 NOTE2, NOTE5 revised
		53	Table 5.39 Parameter: Voltage monitor 1 reset generation time added NOTE5 added
		54	Table 5.40 revised Table 5.41 revised Figure 5.22 revised

All trademarks and registered trademarks are the property of their respective owners.

Notes:

1. This document is provided for reference purposes only so that Renesas customers may select the appropriate Renesas products for their use. Renesas neither makes warranties or representations with respect to the accuracy or completeness of the information contained in this document nor grants any license to any intellectual property rights or any other rights of Renesas or any third party with respect to the information in this document.
2. Renesas shall have no liability for damages or infringement of any intellectual property or other rights arising out of the use of any information in this document, including, but not limited to, product data, diagrams, charts, programs, algorithms, and application circuit examples.
3. You should not use the products or the technology described in this document for the purpose of military applications such as the development of weapons of mass destruction or for the purpose of any other military use. When exporting the products or technology described herein, you should follow the applicable export control laws and regulations, and procedures required by such laws and regulations.
4. All information included in this document such as product data, diagrams, charts, programs, algorithms, and application circuit examples, is current as of the date this document is issued. Such information, however, is subject to change without any prior notice. Before purchasing or using any Renesas products listed in this document, please confirm the latest product information with a Renesas sales office. Also, please pay regular and careful attention to additional and different information to be disclosed by Renesas such as that disclosed through our website. (<http://www.renesas.com>)
5. Renesas has used reasonable care in compiling the information included in this document, but Renesas assumes no liability whatsoever for any damages incurred as a result of errors or omissions in the information included in this document.
6. When using or otherwise relying on the information in this document, you should evaluate the information in light of the total system before deciding about the applicability of such information to the intended application. Renesas makes no representations, warranties or guarantees regarding the suitability of its products for any particular application and specifically disclaims any liability arising out of the application and use of the information in this document or Renesas products.
7. With the exception of products specified by Renesas as suitable for automobile applications, Renesas products are not designed, manufactured or tested for applications or otherwise in systems the failure or malfunction of which may cause a direct threat to human life or create a risk of human injury or which require especially high quality and reliability such as safety systems, or equipment or systems for transportation and traffic, healthcare, combustion control, aerospace and aeronautics, nuclear power, or undersea communication transmission. If you are considering the use of our products for such purposes, please contact a Renesas sales office beforehand. Renesas shall have no liability for damages arising out of the uses set forth above.
8. Notwithstanding the preceding paragraph, you should not use Renesas products for the purposes listed below:
  - (1) artificial life support devices or systems
  - (2) surgical implantations
  - (3) healthcare intervention (e.g., excision, administration of medication, etc.)
  - (4) any other purposes that pose a direct threat to human lifeRenesas shall have no liability for damages arising out of the uses set forth in the above and purchasers who elect to use Renesas products in any of the foregoing applications shall indemnify and hold harmless Renesas Technology Corp., its affiliated companies and their officers, directors, and employees against any and all damages arising out of such applications.
9. You should use the products described herein within the range specified by Renesas, especially with respect to the maximum rating, operating supply voltage range, movement power voltage range, heat radiation characteristics, installation and other product characteristics. Renesas shall have no liability for malfunctions or damages arising out of the use of Renesas products beyond such specified ranges.
10. Although Renesas endeavors to improve the quality and reliability of its products, IC products have specific characteristics such as the occurrence of failure at a certain rate and malfunctions under certain use conditions. Please be sure to implement safety measures to guard against the possibility of physical injury, and injury or damage caused by fire in the event of the failure of a Renesas product, such as safety design for hardware and software including but not limited to redundancy, fire control and malfunction prevention, appropriate treatment for aging degradation or any other applicable measures. Among others, since the evaluation of microcomputer software alone is very difficult, please evaluate the safety of the final products or system manufactured by you.
11. In case Renesas products listed in this document are detached from the products to which the Renesas products are attached or affixed, the risk of accident such as swallowing by infants and small children is very high. You should implement safety measures so that Renesas products may not be easily detached from your products. Renesas shall have no liability for damages arising out of such detachment.
12. This document may not be reproduced or duplicated, in any form, in whole or in part, without prior written approval from Renesas.
13. Please contact a Renesas sales office if you have any questions regarding the information contained in this document, Renesas semiconductor products, or if you have any other inquiries.



**RENESAS SALES OFFICES**

<http://www.renesas.com>

Refer to "<http://www.renesas.com/en/network>" for the latest and detailed information.

**Renesas Technology America, Inc.**  
450 Holger Way, San Jose, CA 95134-1368, U.S.A  
Tel: <1> (408) 382-7500, Fax: <1> (408) 382-7501

**Renesas Technology Europe Limited**  
Dukes Meadow, Millboard Road, Bourne End, Buckinghamshire, SL8 5FH, U.K.  
Tel: <44> (1628) 585-100, Fax: <44> (1628) 585-900

**Renesas Technology (Shanghai) Co., Ltd.**  
Unit 204, 205, AZIACenter, No.1233 Lujiazui Ring Rd, Pudong District, Shanghai, China 200120  
Tel: <86> (21) 5877-1818, Fax: <86> (21) 6887-7858/7898

**Renesas Technology Hong Kong Ltd.**  
7th Floor, North Tower, World Finance Centre, Harbour City, Canton Road, Tsimshatsui, Kowloon, Hong Kong  
Tel: <852> 2265-6688, Fax: <852> 2377-3473

**Renesas Technology Taiwan Co., Ltd.**  
10th Floor, No.99, Fushing North Road, Taipei, Taiwan  
Tel: <886> (2) 2715-2888, Fax: <886> (2) 3518-3399

**Renesas Technology Singapore Pte. Ltd.**  
1 Harbour Front Avenue, #06-10, Keppel Bay Tower, Singapore 098632  
Tel: <65> 6213-0200, Fax: <65> 6278-8001

**Renesas Technology Korea Co., Ltd.**  
Kukje Center Bldg. 18th Fl., 191, 2-ka, Hangang-ro, Yongsan-ku, Seoul 140-702, Korea  
Tel: <82> (2) 796-3115, Fax: <82> (2) 796-2145

**Renesas Technology Malaysia Sdn. Bhd**  
Unit 906, Block B, Menara Amcorp, Amcorp Trade Centre, No.18, Jln Persiaran Barat, 46050 Petaling Jaya, Selangor Darul Ehsan, Malaysia  
Tel: <603> 7955-9390, Fax: <603> 7955-9510