



8-bit Atmel tinyAVR Microcontroller with 16K Bytes In-System Programmable Flash

ATtiny1634

Summary

Features

- High Performance, Low Power AVR[®] 8-bit Microcontroller
- Advanced RISC Architecture
 - 125 Powerful Instructions – Most Single Clock Cycle Execution
 - 32 x 8 General Purpose Working Registers
 - Fully Static Operation
- High Endurance, Non-volatile Memory Segments
 - 16K Bytes of In-System, Self-Programmable Flash Program Memory
 - Endurance: 10,000 Write/Erase Cycles
 - 256 Bytes of In-System Programmable EEPROM
 - Endurance: 100,000 Write/Erase Cycles
 - 1K Byte of Internal SRAM
 - Data retention: 20 years at 85°C / 100 years at 25°C
 - Programming Lock for Self-Programming Flash & EEPROM Data Security
- Peripheral Features
 - Dedicated Hardware and QTouch[®] Library Support for Capacitive Touch Sensing
 - One 8-bit and One 16-bit Timer/Counter with Two PWM Channels, Each
 - 12-channel, 10-bit ADC
 - Programmable Ultra Low Power Watchdog Timer
 - On-chip Analog Comparator
 - Two Full Duplex USARTs with Start Frame Detection
 - Universal Serial Interface
 - Slave I²C Serial Interface
- Special Microcontroller Features
 - debugWIRE On-chip Debug System
 - In-System Programmable via SPI Port
 - Internal and External Interrupt Sources
 - Pin Change Interrupt on 18 Pins
 - Low Power Idle, ADC Noise Reduction, Standby and Power-down Modes
 - Enhanced Power-on Reset Circuit
 - Programmable Brown-out Detection Circuit with Supply Voltage Sampling
 - Calibrated 8MHz Oscillator with Temperature Calibration Option
 - Calibrated 32kHz Ultra Low Power Oscillator
 - On-chip Temperature Sensor
- I/O and Packages
 - 18 Programmable I/O Lines
 - 20-pad QFN/MLF, and 20-pin SOIC
- Operating Voltage:
 - 1.8 – 5.5V
- Speed Grade:
 - 0 – 2MHz @ 1.8 – 5.5V
 - 0 – 8MHz @ 2.7 – 5.5V
 - 0 – 12MHz @ 4.5 – 5.5V
- Temperature Range: -40°C to +105°C
- Low Power Consumption
 - Active Mode: 0.2mA at 1.8V and 1MHz
 - Idle Mode: 30µA at 1.8V and 1MHz
 - Power-Down Mode (WDT Enabled): 1µA at 1.8V
 - Power-Down Mode (WDT Disabled): 100nA at 1.8V

1. Pin Configurations

Figure 1-1. Pinout of ATtiny1634

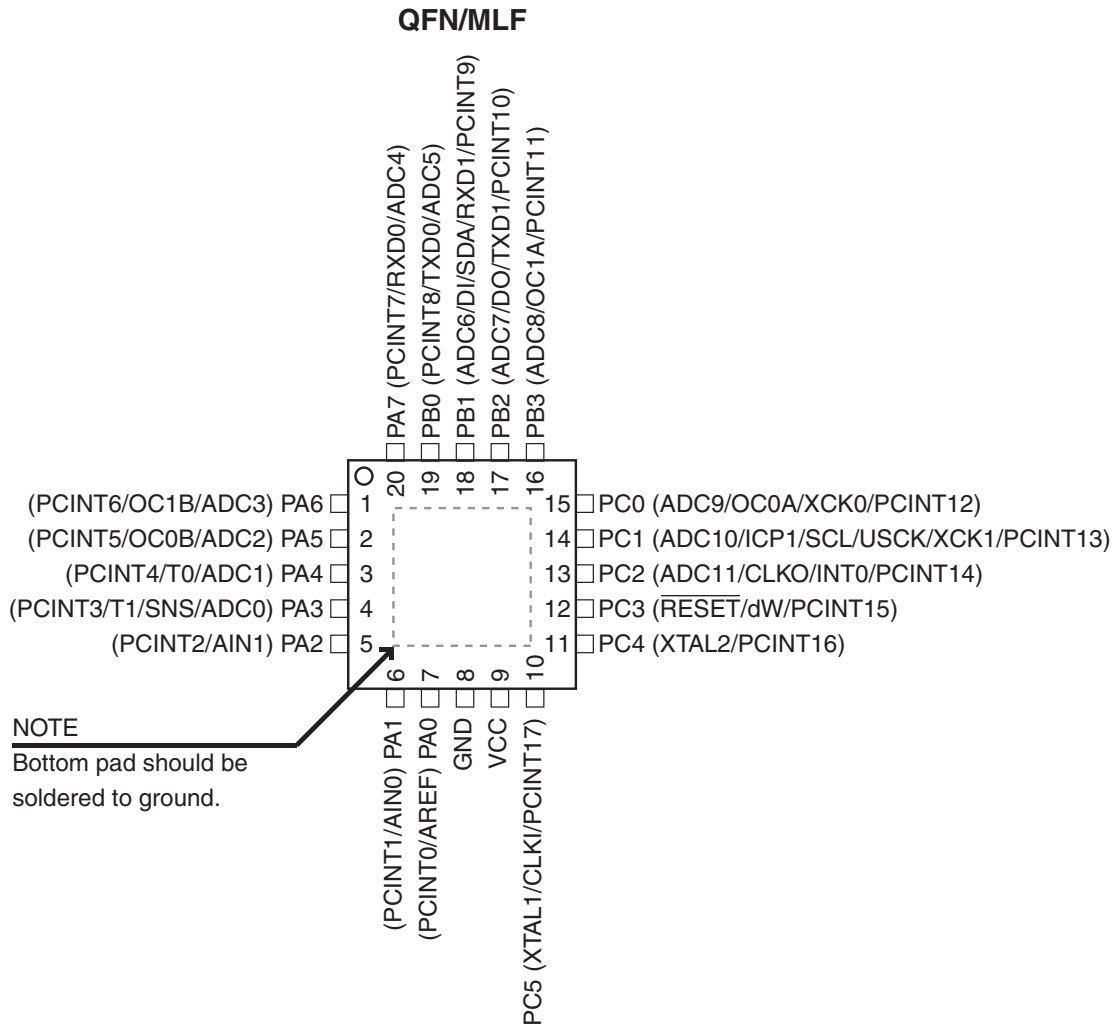
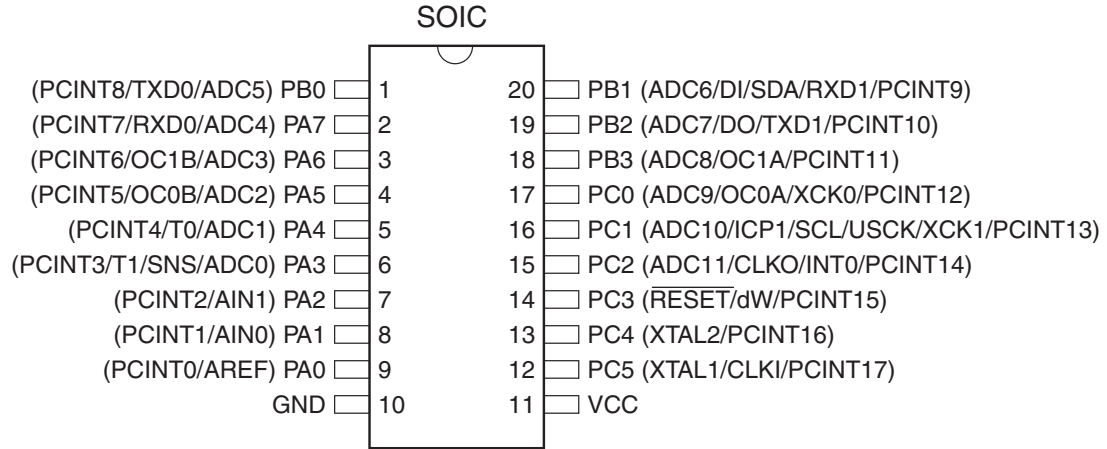

1.1 Pin Descriptions

1.1.1 VCC

Supply voltage.

1.1.2 GND

Ground.

1.1.3 XTAL1

Input to the inverting amplifier of the oscillator and the internal clock circuit. This is an alternative pin configuration of PC5.

1.1.4 XTAL2

Output from the inverting amplifier of the oscillator. Alternative pin configuration of PC4.

1.1.5 $\overline{\text{RESET}}$

Reset input. A low level on this pin for longer than the minimum pulse length will generate a reset, even if the clock is not running and provided the reset pin has not been disabled. The minimum pulse length is given in [Table 24-5 on page 231](#). Shorter pulses are not guaranteed to generate a reset.

The reset pin can also be used as a (weak) I/O pin.

1.1.6 Port A (PA7:PA0)

This is an 8-bit, bi-directional I/O port with internal pull-up resistors (selected for each bit). Output buffers have the following drive characteristics:

- PA7, PA4:PA0: Symmetrical, with standard sink and source capability
- PA6, PA5: Asymmetrical, with high sink and standard source capability

As inputs, port pins that are externally pulled low will source current provided that pull-up resistors are activated. Port pins are tri-stated when a reset condition becomes active, even if the clock is not running.

This port has alternate pin functions to serve special features of the device. See [“Alternate Functions of Port A” on page 62](#).

1.1.7 Port B (PB3:PB0)

This is a 4-bit, bi-directional I/O port with internal pull-up resistors (selected for each bit). Output buffers have the following drive characteristics:

- PB3: Asymmetrical, with high sink and standard source capability
- PB2:PB0: Symmetrical, with standard sink and source capability

As inputs, port pins that are externally pulled low will source current provided that pull-up resistors are activated. Port pins are tri-stated when a reset condition becomes active, even if the clock is not running.

This port has alternate pin functions to serve special features of the device. See [“Alternate Functions of Port B” on page 65](#).

1.1.8 Port C (PC5:PC0)

This is a 6-bit, bi-directional I/O port with internal pull-up resistors (selected for each bit). Output buffers have the following drive characteristics:

- PC5:PC1: Symmetrical, with standard sink and source capability
- PC0: Asymmetrical, with high sink and standard source capability

As inputs, port pins that are externally pulled low will source current provided that pull-up resistors are activated. Port pins are tri-stated when a reset condition becomes active, even if the clock is not running.

This port has alternate pin functions to serve special features of the device. See “Alternate Functions of Port C” on page 67.

2. Overview

ATtiny1634 is a low-power CMOS 8-bit microcontrollers based on the AVR enhanced RISC architecture. By executing powerful instructions in a single clock cycle, the ATtiny1634 achieves throughputs approaching 1 MIPS per MHz allowing the system designer to optimize power consumption versus processing speed.

Figure 2-1. Block Diagram

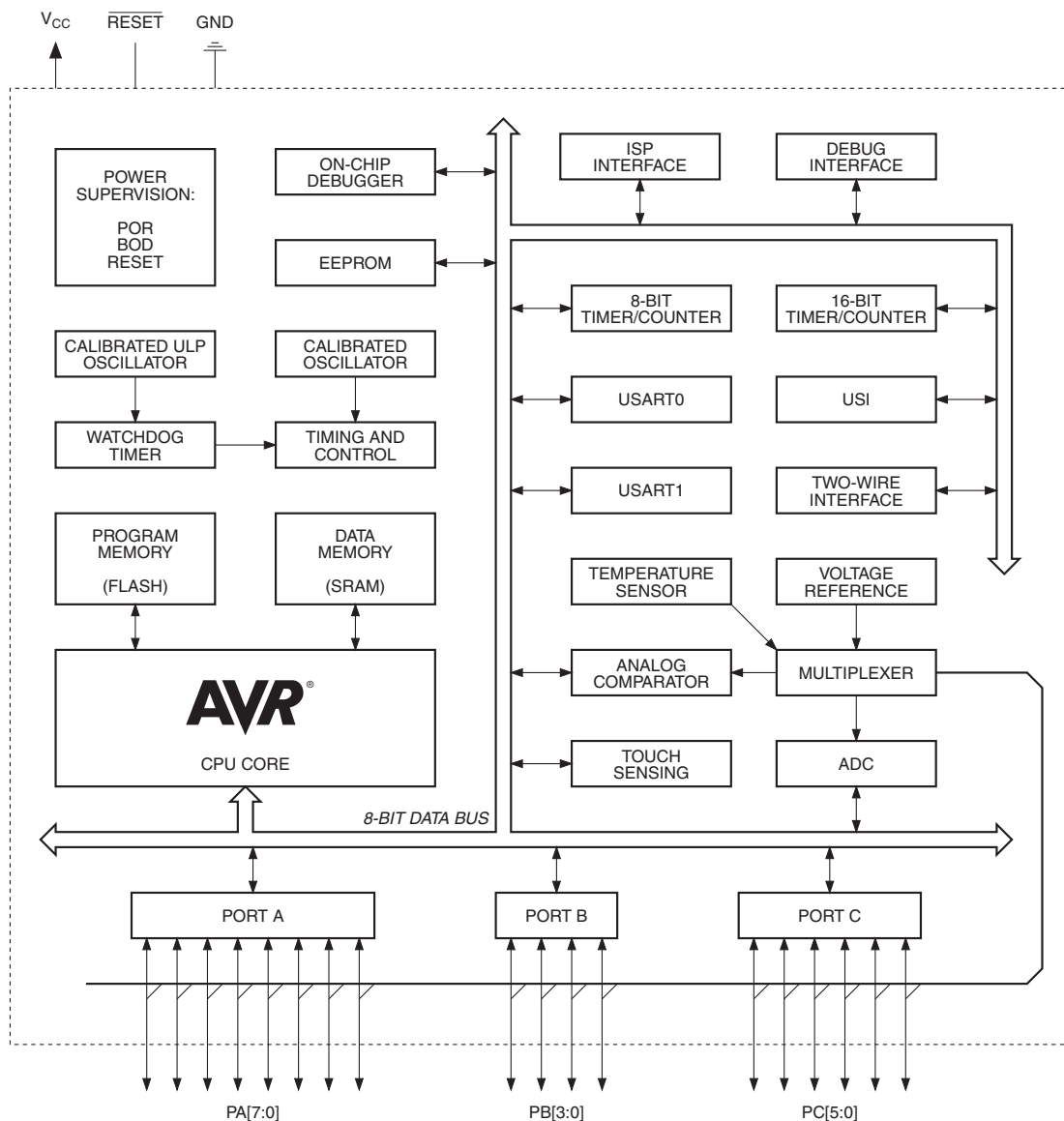

The AVR core combines a rich instruction set with 32 general purpose working registers. All 32 registers are directly connected to the Arithmetic Logic Unit (ALU), allowing two independent registers to be accessed in a single instruction, executed in one clock cycle. The resulting architecture is compact and code efficient while achieving throughputs up to ten times faster than conventional CISC microcontrollers.

ATtiny1634 provides the following features:

- 16K bytes of in-system programmable Flash
- 1K bytes of SRAM data memory
- 256 bytes of EEPROM data memory
- 18 general purpose I/O lines
- 32 general purpose working registers
- An 8-bit timer/counter with two PWM channels
- A 16-bit timer/counter with two PWM channels
- Internal and external interrupts
- A 10-bit ADC with 5 internal and 12 external channels
- An ultra-low power, programmable watchdog timer with internal oscillator
- Two programmable USART's with start frame detection
- A slave Two-Wire Interface (TWI)
- A Universal Serial Interface (USI) with start condition detector
- A calibrated 8MHz oscillator
- A calibrated 32kHz, ultra low power oscillator
- Four software selectable power saving modes.

The device includes the following modes for saving power:

- Idle mode: stops the CPU while allowing the timer/counter, ADC, analog comparator, SPI, TWI, and interrupt system to continue functioning
- ADC Noise Reduction mode: minimizes switching noise during ADC conversions by stopping the CPU and all I/O modules except the ADC
- Power-down mode: registers keep their contents and all chip functions are disabled until the next interrupt or hardware reset
- Standby mode: the oscillator is running while the rest of the device is sleeping, allowing very fast start-up combined with low power consumption.

The device is manufactured using Atmel's high density non-volatile memory technology. The Flash program memory can be re-programmed in-system through a serial interface, by a conventional non-volatile memory programmer or by an on-chip boot code, running on the AVR core.

The ATtiny1634 AVR is supported by a full suite of program and system development tools including: C compilers, macro assemblers, program debugger/simulators and evaluation kits.

3. General Information

3.1 Resources

A comprehensive set of drivers, application notes, data sheets and descriptions on development tools are available for download at <http://www.atmel.com/avr>.

3.2 Code Examples

This documentation contains simple code examples that briefly show how to use various parts of the device. These code examples assume that the part specific header file is included before compilation. Be aware that not all C compiler vendors include bit definitions in the header files and interrupt handling in C is compiler dependent. Please confirm with the C compiler documentation for more details.

For I/O Registers located in the extended I/O map, “IN”, “OUT”, “SBIS”, “SBIC”, “CBI”, and “SBI” instructions must be replaced with instructions that allow access to extended I/O. Typically, this means “LDS” and “STS” combined with “SBRS”, “SBRC”, “SBR”, and “CBR”. Note that not all AVR devices include an extended I/O map.

3.3 Capacitive Touch Sensing

Atmel QTouch Library provides a simple to use solution for touch sensitive interfaces on Atmel AVR microcontrollers. The QTouch Library includes support for QTouch® and QMatrix® acquisition methods.

Touch sensing is easily added to any application by linking the QTouch Library and using the Application Programming Interface (API) of the library to define the touch channels and sensors. The application then calls the API to retrieve channel information and determine the state of the touch sensor.

The QTouch Library is free and can be downloaded from the Atmel website. For more information and details of implementation, refer to the QTouch Library User Guide – also available from the Atmel website.

3.4 Data Retention

Reliability Qualification results show that the projected data retention failure rate is much less than 1 PPM over 20 years at 85°C or 100 years at 25°C.

4. CPU Core

This section discusses the AVR core architecture in general. The main function of the CPU core is to ensure correct program execution. The CPU must therefore be able to access memories, perform calculations, control peripherals, and handle interrupts.

5. Register Summary

Address	Name	Bit 7	Bit 6	Bit 5	Bit 4	Bit 3	Bit 2	Bit 1	Bit 0	Page(s)
(0xFF)	Reserved	–	–	–	–	–	–	–	–	
(0xFE)	Reserved	–	–	–	–	–	–	–	–	
(0xFD)	Reserved	–	–	–	–	–	–	–	–	
(0xFC)	Reserved	–	–	–	–	–	–	–	–	
(0xFB)	Reserved	–	–	–	–	–	–	–	–	
(0xFA)	Reserved	–	–	–	–	–	–	–	–	
(0xF9)	Reserved	–	–	–	–	–	–	–	–	
...
(0x85)	Reserved	–	–	–	–	–	–	–	–	
(0x84)	Reserved	–	–	–	–	–	–	–	–	
(0x83)	Reserved	–	–	–	–	–	–	–	–	
(0x82)	Reserved	–	–	–	–	–	–	–	–	
(0x81)	Reserved	–	–	–	–	–	–	–	–	
(0x80)	Reserved	–	–	–	–	–	–	–	–	
(0x7F)	TWSCRA	TWSHE	–	TWDIE	TWASIE	TWEN	TWSIE	TWPME	TWSME	127
(0x7E)	TWSCRAB	–	–	–	–	–	TWAA	TWCMD[1:0]		127
(0x7D)	TWSSRA	TWDIF	TWASIF	TWCH	TWRA	TWC	TWBE	TWDIR	TWAS	128
(0x7C)	TWSA	TWI Slave Address Register								130
(0x7B)	TWSAM	TWI Slave Address Mask Register								130
(0x7A)	TWSD	TWI Slave Data Register								130
(0x79)	UCSR1A	RXC1	TXC1	UDRE1	FE1	DOR1	UPE1	U2X1	MPCM1	167
(0x78)	UCSR1B	RXCIE1	TXCIE1	UDRIE1	RXEN1	TXEN1	UCSZ12	RXB81	TXB81	168
(0x77)	UCSR1C	UMSEL11	UMSEL10	UPM11	UPM01	USBS1	UCSZ11	UCSZ10	UCPOL1	169
(0x76)	UCSR1D	RXSIE1	RXS1	SFDE1	–	–	–	–	–	171
(0x75)	UBRR1H	USART1 Baud Rate Register High Byte								172
(0x74)	UBRR1L	USART1 Baud Rate Register Low Byte								172
(0x73)	UDR1	USART1 I/O Data Register								167
(0x72)	TCCR1A	COM1A1	COM1A0	COM1B1	COM1B0	–	–	WGM11	WGM10	111
(0x71)	TCCR1B	ICNC1	ICES1	–	WGM13	WGM12	CS12	CS11	CS10	113
(0x70)	TCCR1C	FOC1A	FOC1B	–	–	–	–	–	–	114
(0x6F)	TCNT1H	Timer/Counter1 – Counter Register High Byte								114
(0x6E)	TCNT1L	Timer/Counter1 – Counter Register Low Byte								114
(0x6D)	OCR1AH	Timer/Counter1 – Compare Register A High Byte								114
(0x6C)	OCR1AL	Timer/Counter1 – Compare Register A Low Byte								114
(0x6B)	OCR1BH	Timer/Counter1 – Compare Register B High Byte								115
(0x6A)	OCR1BL	Timer/Counter1 – Compare Register B Low Byte								115
(0x69)	ICR1H	Timer/Counter1 – Input Capture Register High Byte								115
(0x68)	ICR1L	Timer/Counter1 – Input Capture Register Low Byte								115
(0x67)	GTCCR	TSM	–	–	–	–	–	–	PSR10	118
(0x66)	OSCCAL1	–	–	–	–	–	–	CAL11	CAL10	33
(0x65)	OSCTCAL0B	Oscillator Temperature Compensation Register B								33
(0x64)	OSCTCAL0A	Oscillator Temperature Compensation Register A								33
(0x63)	OSCCAL0	CAL07	CAL06	CAL05	CAL04	CAL03	CAL02	CAL01	CAL00	32
(0x62)	DIDR2	–	–	–	–	–	ADC11D	ADC10D	ADC9D	200
(0x61)	DIDR1	–	–	–	–	ADC8D	ADC7D	ADC6D	ADC5D	200
(0x60)	DIDR0	ADC4D	ADC3D	ADC2D	ADC1D	ADC0D	AIN1D	AIN0D	AREFD	184, 200
0x3F (0x5F)	SREG	I	T	H	S	V	N	Z	C	14
0x3E (0x5E)	SPH	–	–	–	–	–	SP10	SP9	SP8	13
0x3D (0x5D)	SPL	SP7	SP6	SP5	SP4	SP3	SP2	SP1	SP0	13
0x3C (0x5C)	GIMSK	–	INT0	PCIE2	PCIE1	PCIE0	–	–	–	51
0x3B (0x5B)	GIFR	–	INTF0	PCIF2	PCIF1	PCIF0	–	–	–	52
0x3A (0x5A)	TIMSK	TOIE1	OCIE1A	OCIE1B	–	ICIE1	OCIE0B	TOIE0	OCIE0A	88, 115
0x39 (0x59)	TIFR	TOV1	OCF1A	OCF1B	–	ICF1	OCF0B	TOV0	OCF0A	89, 116
0x38 (0x58)	QTCR	QTouch Control and Status Register								6
0x37 (0x57)	SPMCSR	–	–	RSIG	CTPB	RFLB	PGWRT	PGERS	SPMEN	207
0x36 (0x56)	MCUCR	–	SM1	SM0	SE	–	–	ISC01	ISC00	37, 51
0x35 (0x55)	MCUSR	–	–	–	–	WDRF	BORF	EXTRF	PORF	44
0x34 (0x54)	PRR	–	PRTWI	PRTIM0	PRTIM0	PRUSI	PRUSART1	PRUSART0	PRADC	38
0x33 (0x53)	CLKPR	–	–	–	–	CLKPS3	CLKPS2	CLKPS1	CLKPS0	31
0x32 (0x52)	CLKSR	OSCRDY	CSTR	CKOUT_IO	SUT	CKSEL3	CKSEL2	CKSEL1	CKSEL0	29
0x31 (0x51)	Reserved	–	–	–	–	–	–	–	–	
0x30 (0x50)	WDTCR	WDIF	WDIE	WDP3	–	WDE	WDP2	WDP1	WDPO	45
0x2F (0x4F)	CCP	CPU Change Protection Register								13
0x2E (0x4E)	DWDR	DWDR[7:0]								202
0x2D (0x4D)	USIBR	USI Buffer Register								144
0x2C (0x4C)	USIDR	USI Data Register								143

Address	Name	Bit 7	Bit 6	Bit 5	Bit 4	Bit 3	Bit 2	Bit 1	Bit 0	Page(s)
0x2B (0x4B)	USISR	USISIF	USIOIF	USIPF	USIDC	USICNT3	USICNT2	USICNT1	USICNT0	142
0x2A (0x4A)	USICR	USISIE	USIOIE	USIWM1	USIWM0	USICS1	USICS0	USICLK	USITC	140
0x29 (0x49)	PCMSK2	–	–	PCINT17	PCINT16	PCINT15	PCINT14	PCINT13	PCINT12	52
0x28 (0x48)	PCMSK1	–	–	–	–	PCINT11	PCINT10	PCINT9	PCINT8	53
0x27 (0x47)	PCMSK0	PCINT7	PCINT6	PCINT5	PCINT4	PCINT3	PCINT2	PCINT1	PCINT0	53
0x26 (0x46)	UCSR0A	RXC0	TXC0	UDRE0	FE0	DOR0	UPE0	U2X0	MPCM	167
0x25 (0x45)	UCSR0B	RXCIE0	TXCIE0	UDRIE0	RXEN0	TXEN0	UCSZ02	RXB80	TXB80	168
0x24 (0x44)	UCSR0C	UMSEL01	UMSEL00	UPM01	UPM00	USBS0	UCSZ01	UCSZ00	UCPOL0	169
0x23 (0x43)	UCSR0D	RXCIE0	RXS0	SFDE0	–	–	–	–	–	171
0x22 (0x42)	UBRR0H	–	–	–	–	USART0 Baud Rate Register High Byte				172
0x21 (0x41)	UBRR0L	USART0 Baud Rate Register Low Byte								172
0x20 (0x40)	UDR0	USART0 I/O Data Register								167
0x1F (0x3F)	EEARH	–	–	–	–	–	–	–	–	
0x1E (0x3E)	EEARL	EEAR[7:0]								22
0x1D (0x3D)	EEDR	EEPROM Data Register								22
0x1C (0x3C)	EECR	–	–	EEM1	EEM0	EERIE	EEMPE	EEPE	EERE	22
0x1B (0x3B)	TCCR0A	COM0A1	COM0A0	COM0B1	COM0B0	–	–	WGM01	WGM00	84
0x1A (0x3A)	TCCR0B	FOC0A	FOC0B	–	–	WGM02	CS02	CS01	CS00	86
0x19 (0x39)	TCNT0	Timer/Counter0								88
0x18 (0x38)	OCR0A	Timer/Counter0 – Compare Register A								88
0x17 (0x37)	OCR0B	Timer/Counter0 – Compare Register B								88
0x16 (0x36)	GPOR2	General Purpose Register 2								23
0x15 (0x35)	GPOR1	General Purpose Register 1								24
0x14 (0x34)	GPOR0	General Purpose Register 0								24
0x13 (0x33)	PORTCR	–	–	–	–	–	BBMC	BBMB	BBMA	71
0x12 (0x32)	PUEA	PUEA7	PUEA6	PUEA5	PUEA4	PUEA3	PUEA2	PUEA1	PUEA0	71
0x11 (0x31)	PORTA	PORTA7	PORTA6	PORTA5	PORTA4	PORTA3	PORTA2	PORTA1	PORTA0	71
0x10 (0x30)	DDRA	DDA7	DDA6	DDA5	DDA4	DDA3	DDA2	DDA1	DDA0	71
0x0F (0x2F)	PINA	PINA7	PINA6	PINA5	PINA4	PINA3	PINA2	PINA1	PINA0	71
0x0E (0x2E)	PUEB	–	–	–	–	PUEB3	PUEB2	PUEB1	PUEB0	72
0x0D (0x2D)	PORTB	–	–	–	–	PORTB3	PORTB2	PORTB1	PORTB0	72
0x0C (0x2C)	DDRB	–	–	–	–	DDB3	DDB2	DDB1	DDB0	72
0x0B (0x2B)	PINB	–	–	–	–	PINB3	PINB2	PINB1	PINB0	72
0x0A (0x2A)	PUEC	–	–	PUEC5	PUEC4	PUEC3	PUEC2	PUEC1	PUEC0	72
0x09 (0x29)	PORTC	–	–	PORTC5	PORTC4	PORTC3	PORTC2	PORTC1	PORTC0	72
0x08 (0x28)	DDRC	–	–	DDC5	DDC4	DDC3	DDC2	DDC1	DDC0	72
0x07 (0x27)	PINC	–	–	PINC5	PINC4	PINC3	PINC2	PINC1	PINC0	72
0x06 (0x26)	ACSR	ACD	ACBG	ACO	ACI	ACIE	ACIC	ACIS1	ACIS0	182
0x05 (0x25)	ACSRB	HSEL	HLEV	ACLP	–	ACCE	ACME	ACIRS1	ACIRS0	183
0x04 (0x24)	ADMUX	REFS1	REFS0	REFEN	ADC0EN	MUX3	MUX2	MUX1	MUX0	196
0x03 (0x23)	ADCSRA	ADEN	ADSC	ADATE	ADIF	ADIE	ADPS2	ADPS1	ADPS0	197
0x02 (0x22)	ADCSRB	VDEN	VDPD	–	–	ADLAR	ADTS2	ADTS1	ADTS0	199
0x01 (0x21)	ADCH	ADC Data Register High Byte								198
0x00 (0x20)	ADCL	ADC Data Register Low Byte								198

- Note:
1. For compatibility with future devices, reserved bits should be written to zero if accessed. Reserved I/O memory addresses should never be written.
 2. I/O Registers within the address range 0x00 - 0x1F are directly bit-accessible using the SBI and CBI instructions. In these registers, the value of single bits can be checked by using the SBIS and SBIC instructions.
 3. Some of the Status Flags are cleared by writing a logical one to them. Note that, unlike most other AVR, the CBI and SBI instructions will only operation the specified bit, and can therefore be used on registers containing such Status Flags. The CBI and SBI instructions work with registers 0x00 to 0x1F only.

6. Instruction Set Summary

Mnemonics	Operands	Description	Operation	Flags	#Clocks
ARITHMETIC AND LOGIC INSTRUCTIONS					
ADD	Rd, Rr	Add two Registers	$Rd \leftarrow Rd + Rr$	Z,C,N,V,H	1
ADC	Rd, Rr	Add with Carry two Registers	$Rd \leftarrow Rd + Rr + C$	Z,C,N,V,H	1
ADIW	Rdl,K	Add Immediate to Word	$Rdh:Rdl \leftarrow Rdh:Rdl + K$	Z,C,N,V,S	2
SUB	Rd, Rr	Subtract two Registers	$Rd \leftarrow Rd - Rr$	Z,C,N,V,H	1
SUBI	Rd, K	Subtract Constant from Register	$Rd \leftarrow Rd - K$	Z,C,N,V,H	1
SBC	Rd, Rr	Subtract with Carry two Registers	$Rd \leftarrow Rd - Rr - C$	Z,C,N,V,H	1
SBCI	Rd, K	Subtract with Carry Constant from Reg.	$Rd \leftarrow Rd - K - C$	Z,C,N,V,H	1
SBIW	Rdl,K	Subtract Immediate from Word	$Rdh:Rdl \leftarrow Rdh:Rdl - K$	Z,C,N,V,S	2
AND	Rd, Rr	Logical AND Registers	$Rd \leftarrow Rd \cdot Rr$	Z,N,V	1
ANDI	Rd, K	Logical AND Register and Constant	$Rd \leftarrow Rd \cdot K$	Z,N,V	1
OR	Rd, Rr	Logical OR Registers	$Rd \leftarrow Rd \vee Rr$	Z,N,V	1
ORI	Rd, K	Logical OR Register and Constant	$Rd \leftarrow Rd \vee K$	Z,N,V	1
EOR	Rd, Rr	Exclusive OR Registers	$Rd \leftarrow Rd \oplus Rr$	Z,N,V	1
COM	Rd	One's Complement	$Rd \leftarrow 0xFF - Rd$	Z,C,N,V	1
NEG	Rd	Two's Complement	$Rd \leftarrow 0x00 - Rd$	Z,C,N,V,H	1
SBR	Rd,K	Set Bit(s) in Register	$Rd \leftarrow Rd \vee K$	Z,N,V	1
CBR	Rd,K	Clear Bit(s) in Register	$Rd \leftarrow Rd \cdot (0xFF - K)$	Z,N,V	1
INC	Rd	Increment	$Rd \leftarrow Rd + 1$	Z,N,V	1
DEC	Rd	Decrement	$Rd \leftarrow Rd - 1$	Z,N,V	1
TST	Rd	Test for Zero or Minus	$Rd \leftarrow Rd \cdot Rd$	Z,N,V	1
CLR	Rd	Clear Register	$Rd \leftarrow Rd \oplus Rd$	Z,N,V	1
SER	Rd	Set Register	$Rd \leftarrow 0xFF$	None	1
BRANCH INSTRUCTIONS					
JMP	k	Direct Jump	$PC \leftarrow k$	None	3
RJMP	k	Relative Jump	$PC \leftarrow PC + k + 1$	None	2
IJMP		Indirect Jump to (Z)	$PC \leftarrow Z$	None	2
CALL	k	Direct Subroutine	$PC \leftarrow k$	None	4
RCALL	k	Relative Subroutine Call	$PC \leftarrow PC + k + 1$	None	3
ICALL		Indirect Call to (Z)	$PC \leftarrow Z$	None	3
RET		Subroutine Return	$PC \leftarrow STACK$	None	4
RETI		Interrupt Return	$PC \leftarrow STACK$	I	4
CPSE	Rd,Rr	Compare, Skip if Equal	if $(Rd = Rr)$ $PC \leftarrow PC + 2$ or 3	None	1/2/3
CP	Rd,Rr	Compare	$Rd - Rr$	Z, N, V, C, H	1
CPC	Rd,Rr	Compare with Carry	$Rd - Rr - C$	Z, N, V, C, H	1
CPI	Rd,K	Compare Register with Immediate	$Rd - K$	Z, N, V, C, H	1
SBRC	Rr, b	Skip if Bit in Register Cleared	if $(Rr(b)=0)$ $PC \leftarrow PC + 2$ or 3	None	1/2/3
SBRs	Rr, b	Skip if Bit in Register is Set	if $(Rr(b)=1)$ $PC \leftarrow PC + 2$ or 3	None	1/2/3
SBIC	P, b	Skip if Bit in I/O Register Cleared	if $(P(b)=0)$ $PC \leftarrow PC + 2$ or 3	None	1/2/3
SBSI	P, b	Skip if Bit in I/O Register is Set	if $(P(b)=1)$ $PC \leftarrow PC + 2$ or 3	None	1/2/3
BRBS	s, k	Branch if Status Flag Set	if $(SREG(s) = 1)$ then $PC \leftarrow PC + k + 1$	None	1/2
BRBC	s, k	Branch if Status Flag Cleared	if $(SREG(s) = 0)$ then $PC \leftarrow PC + k + 1$	None	1/2
BREQ	k	Branch if Equal	if $(Z = 1)$ then $PC \leftarrow PC + k + 1$	None	1/2
BRNE	k	Branch if Not Equal	if $(Z = 0)$ then $PC \leftarrow PC + k + 1$	None	1/2
BRCS	k	Branch if Carry Set	if $(C = 1)$ then $PC \leftarrow PC + k + 1$	None	1/2
BRCC	k	Branch if Carry Cleared	if $(C = 0)$ then $PC \leftarrow PC + k + 1$	None	1/2
BRSH	k	Branch if Same or Higher	if $(C = 0)$ then $PC \leftarrow PC + k + 1$	None	1/2
BRLO	k	Branch if Lower	if $(C = 1)$ then $PC \leftarrow PC + k + 1$	None	1/2
BRMI	k	Branch if Minus	if $(N = 1)$ then $PC \leftarrow PC + k + 1$	None	1/2
BRPL	k	Branch if Plus	if $(N = 0)$ then $PC \leftarrow PC + k + 1$	None	1/2
BRGE	k	Branch if Greater or Equal, Signed	if $(N \oplus V = 0)$ then $PC \leftarrow PC + k + 1$	None	1/2
BRLT	k	Branch if Less Than Zero, Signed	if $(N \oplus V = 1)$ then $PC \leftarrow PC + k + 1$	None	1/2
BRHS	k	Branch if Half Carry Flag Set	if $(H = 1)$ then $PC \leftarrow PC + k + 1$	None	1/2
BRHC	k	Branch if Half Carry Flag Cleared	if $(H = 0)$ then $PC \leftarrow PC + k + 1$	None	1/2
BRTS	k	Branch if T Flag Set	if $(T = 1)$ then $PC \leftarrow PC + k + 1$	None	1/2
BRTC	k	Branch if T Flag Cleared	if $(T = 0)$ then $PC \leftarrow PC + k + 1$	None	1/2
BRVS	k	Branch if Overflow Flag is Set	if $(V = 1)$ then $PC \leftarrow PC + k + 1$	None	1/2
BRVC	k	Branch if Overflow Flag is Cleared	if $(V = 0)$ then $PC \leftarrow PC + k + 1$	None	1/2
BRIE	k	Branch if Interrupt Enabled	if $(I = 1)$ then $PC \leftarrow PC + k + 1$	None	1/2
BRID	k	Branch if Interrupt Disabled	if $(I = 0)$ then $PC \leftarrow PC + k + 1$	None	1/2
BIT AND BIT-TEST INSTRUCTIONS					
SBI	P,b	Set Bit in I/O Register	$I/O(P,b) \leftarrow 1$	None	2
CBI	P,b	Clear Bit in I/O Register	$I/O(P,b) \leftarrow 0$	None	2
LSL	Rd	Logical Shift Left	$Rd(n+1) \leftarrow Rd(n), Rd(0) \leftarrow 0$	Z,C,N,V	1
LSR	Rd	Logical Shift Right	$Rd(n) \leftarrow Rd(n+1), Rd(7) \leftarrow 0$	Z,C,N,V	1
ROL	Rd	Rotate Left Through Carry	$Rd(0) \leftarrow C, Rd(n+1) \leftarrow Rd(n), C \leftarrow Rd(7)$	Z,C,N,V	1

Mnemonics	Operands	Description	Operation	Flags	#Clocks
ROR	Rd	Rotate Right Through Carry	$Rd(7) \leftarrow C, Rd(n) \leftarrow Rd(n+1), C \leftarrow Rd(0)$	Z,C,N,V	1
ASR	Rd	Arithmetic Shift Right	$Rd(n) \leftarrow Rd(n+1), n=0..6$	Z,C,N,V	1
SWAP	Rd	Swap Nibbles	$Rd(3..0) \leftarrow Rd(7..4), Rd(7..4) \leftarrow Rd(3..0)$	None	1
BSET	s	Flag Set	$SREG(s) \leftarrow 1$	SREG(s)	1
BCLR	s	Flag Clear	$SREG(s) \leftarrow 0$	SREG(s)	1
BST	Rr, b	Bit Store from Register to T	$T \leftarrow Rr(b)$	T	1
BLD	Rd, b	Bit load from T to Register	$Rd(b) \leftarrow T$	None	1
SEC		Set Carry	$C \leftarrow 1$	C	1
CLC		Clear Carry	$C \leftarrow 0$	C	1
SEN		Set Negative Flag	$N \leftarrow 1$	N	1
CLN		Clear Negative Flag	$N \leftarrow 0$	N	1
SEZ		Set Zero Flag	$Z \leftarrow 1$	Z	1
CLZ		Clear Zero Flag	$Z \leftarrow 0$	Z	1
SEI		Global Interrupt Enable	$I \leftarrow 1$	I	1
CLI		Global Interrupt Disable	$I \leftarrow 0$	I	1
SES		Set Signed Test Flag	$S \leftarrow 1$	S	1
CLS		Clear Signed Test Flag	$S \leftarrow 0$	S	1
SEV		Set Twos Complement Overflow.	$V \leftarrow 1$	V	1
CLV		Clear Twos Complement Overflow	$V \leftarrow 0$	V	1
SET		Set T in SREG	$T \leftarrow 1$	T	1
CLT		Clear T in SREG	$T \leftarrow 0$	T	1
SEH		Set Half Carry Flag in SREG	$H \leftarrow 1$	H	1
CLH		Clear Half Carry Flag in SREG	$H \leftarrow 0$	H	1
DATA TRANSFER INSTRUCTIONS					
MOV	Rd, Rr	Move Between Registers	$Rd \leftarrow Rr$	None	1
MOVW	Rd, Rr	Copy Register Word	$Rd+1:Rd \leftarrow Rr+1:Rr$	None	1
LDI	Rd, K	Load Immediate	$Rd \leftarrow K$	None	1
LD	Rd, X	Load Indirect	$Rd \leftarrow (X)$	None	2
LD	Rd, X+	Load Indirect and Post-Inc.	$Rd \leftarrow (X), X \leftarrow X + 1$	None	2
LD	Rd, -X	Load Indirect and Pre-Dec.	$X \leftarrow X - 1, Rd \leftarrow (X)$	None	2
LD	Rd, Y	Load Indirect	$Rd \leftarrow (Y)$	None	2
LD	Rd, Y+	Load Indirect and Post-Inc.	$Rd \leftarrow (Y), Y \leftarrow Y + 1$	None	2
LD	Rd, -Y	Load Indirect and Pre-Dec.	$Y \leftarrow Y - 1, Rd \leftarrow (Y)$	None	2
LDD	Rd, Y+q	Load Indirect with Displacement	$Rd \leftarrow (Y + q)$	None	2
LD	Rd, Z	Load Indirect	$Rd \leftarrow (Z)$	None	2
LD	Rd, Z+	Load Indirect and Post-Inc.	$Rd \leftarrow (Z), Z \leftarrow Z + 1$	None	2
LD	Rd, -Z	Load Indirect and Pre-Dec.	$Z \leftarrow Z - 1, Rd \leftarrow (Z)$	None	2
LDD	Rd, Z+q	Load Indirect with Displacement	$Rd \leftarrow (Z + q)$	None	2
LDS	Rd, k	Load Direct from SRAM	$Rd \leftarrow (k)$	None	2
ST	X, Rr	Store Indirect	$(X) \leftarrow Rr$	None	2
ST	X+, Rr	Store Indirect and Post-Inc.	$(X) \leftarrow Rr, X \leftarrow X + 1$	None	2
ST	-X, Rr	Store Indirect and Pre-Dec.	$X \leftarrow X - 1, (X) \leftarrow Rr$	None	2
ST	Y, Rr	Store Indirect	$(Y) \leftarrow Rr$	None	2
ST	Y+, Rr	Store Indirect and Post-Inc.	$(Y) \leftarrow Rr, Y \leftarrow Y + 1$	None	2
ST	-Y, Rr	Store Indirect and Pre-Dec.	$Y \leftarrow Y - 1, (Y) \leftarrow Rr$	None	2
STD	Y+q, Rr	Store Indirect with Displacement	$(Y + q) \leftarrow Rr$	None	2
ST	Z, Rr	Store Indirect	$(Z) \leftarrow Rr$	None	2
ST	Z+, Rr	Store Indirect and Post-Inc.	$(Z) \leftarrow Rr, Z \leftarrow Z + 1$	None	2
ST	-Z, Rr	Store Indirect and Pre-Dec.	$Z \leftarrow Z - 1, (Z) \leftarrow Rr$	None	2
STD	Z+q, Rr	Store Indirect with Displacement	$(Z + q) \leftarrow Rr$	None	2
STS	k, Rr	Store Direct to SRAM	$(k) \leftarrow Rr$	None	2
LPM		Load Program Memory	$R0 \leftarrow (Z)$	None	3
LPM	Rd, Z	Load Program Memory	$Rd \leftarrow (Z)$	None	3
LPM	Rd, Z+	Load Program Memory and Post-Inc	$Rd \leftarrow (Z), Z \leftarrow Z + 1$	None	3
SPM		Store Program Memory	$(z) \leftarrow R1:R0$	None	
IN	Rd, P	In Port	$Rd \leftarrow P$	None	1
OUT	P, Rr	Out Port	$P \leftarrow Rr$	None	1
PUSH	Rr	Push Register on Stack	$STACK \leftarrow Rr$	None	2
POP	Rd	Pop Register from Stack	$Rd \leftarrow STACK$	None	2
MCU CONTROL INSTRUCTIONS					
NOP		No Operation		None	1
SLEEP		Sleep	(see specific descr. for Sleep function)	None	1
WDR		Watchdog Reset	(see specific descr. for WDR/Timer)	None	1
BREAK		Break	For On-chip Debug Only	None	N/A

7. Ordering Information

7.1 ATtiny1634

Speed (MHz) ⁽¹⁾	Supply Voltage (V)	Temperature Range	Package ⁽²⁾	Accuracy ⁽³⁾	Ordering Code ⁽⁴⁾
12	1.8 – 5.5	Industrial (-40°C to +85°C) ⁽⁵⁾	20M1	±10%	ATtiny1634-MU
				±2%	ATtiny1634R-MU
				±10%	ATtiny1634-MUR
				±2%	ATtiny1634R-MUR
			20S2	±10%	ATtiny1634-SU
				±2%	ATtiny1634R-SU
				±10%	ATtiny1634-SUR
				±2%	ATtiny1634R-SUR
		Extended (-40°C to +105°C) ⁽⁵⁾	20M1	±10%	ATtiny1634-MN
				±10%	ATtiny1634-MNR

- Notes:
1. For speed vs. supply voltage, see section [24.3 “Speed” on page 229](#).
 2. All packages are Pb-free, halide-free and fully green, and they comply with the European directive for Restriction of Hazardous Substances (RoHS).
 3. Denotes accuracy of the internal oscillator. See [Table 24-2 on page 230](#).
 4. Code indicators:
 - U: matte tin
 - R: tape & reel
 5. Can also be supplied in wafer form. Contact your local Atmel sales office for ordering information and minimum quantities.

Package Type	
20M1	20-pad, 4 x 4 x 0.8 mm Body, Quad Flat No-Lead / Micro Lead Frame Package (QFN/MLF)
20S2	20-lead, 0.300" Wide Body, Plastic Gull Wing Small Outline Package (SOIC)

8. Packaging Information

8.1 20M1

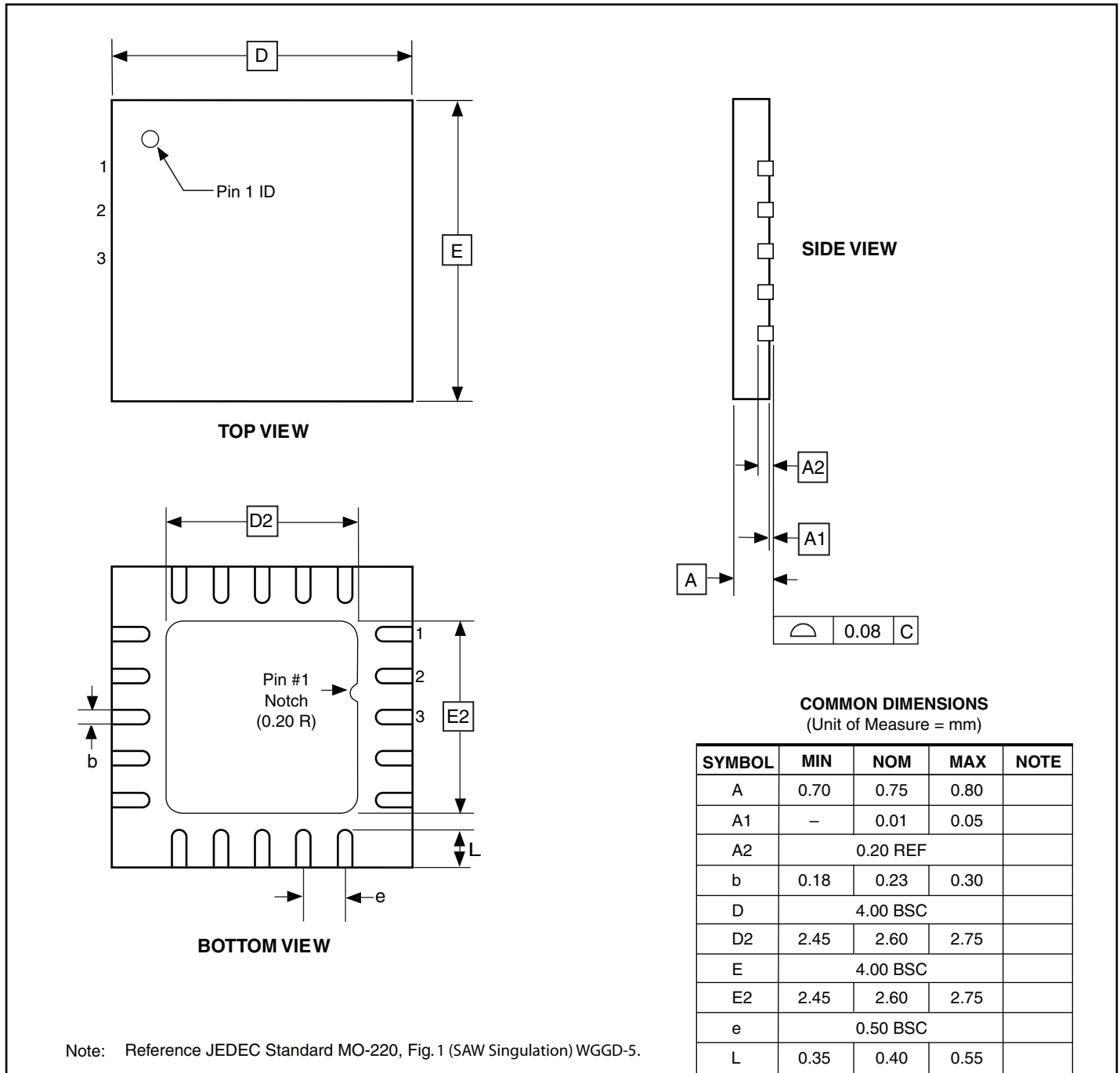

12/02/2014

Atmel 2325 Orchard Parkway
San Jose, CA 95131

TITLE
20M1, 20-pad, 4 x 4 x 0.8 mm Body, Lead Pitch 0.50 mm,
2.6 mm Exposed Pad, Micro Lead Frame Package (MLF)

DRAWING NO.
20M1

REV.
B

8.2 20S2

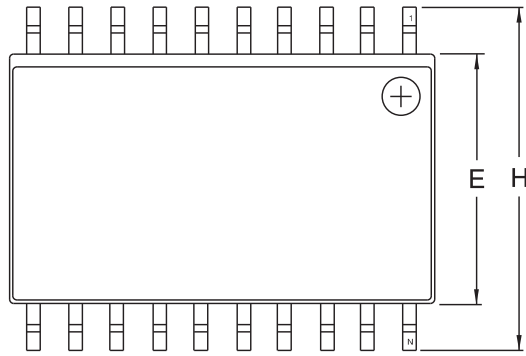

Top View

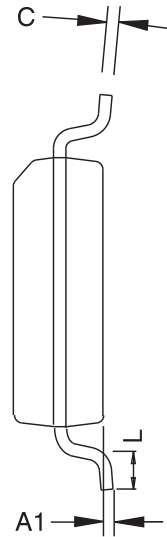

End View

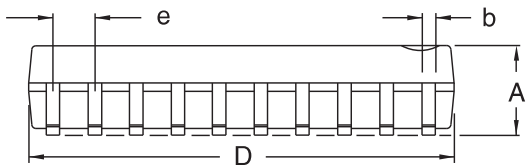

Side View

COMMON DIMENSIONS
(Unit of Measure – mm)

SYMBOL	MIN	NOM	MAX	NOTE
A	2.35		2.65	
A1	0.10		0.30	
b	0.33		0.51	4
C	0.23		0.32	
D	12.60		13.00	1
E	7.40		7.60	2
H	10.00		10.65	
L	0.40		1.27	3
e	1.27 BSC			

- Notes. 1. This drawing is for general information only; refer to JEDEC Drawing MS-013, Variation AC for additional information.
 2. Dimension 'D' does not include mold Flash, protrusions or gate burrs. Mold Flash, protrusions and gate burrs shall not exceed 0.15 mm (0.006') per side.
 3. Dimension 'E' does not include inter-lead Flash or protrusion. Inter-lead Flash and protrusions shall not exceed 0.25 mm (0.010') per side.
 4. 'L' is the length of the terminal for soldering to a substrate.
 5. The lead width 'b', as measured 0.36 mm (0.014') or greater above the seating plane, shall not exceed a maximum value of 0.61 mm (0.024') per side.

2325 Orchard Parkway San Jose, CA 95131	TITLE 20S2, 20-lead, 0.300' Wide Body, Plastic Gull Wing Small Outline Package (SOIC)	DRAWING NO.	REV.
		20S2	B

9. Errata

The revision letters in this section refer to the revision of the corresponding ATtiny1634 device.

9.1 ATtiny1634

9.1.1 Rev. C

- **Port Pin Should Not Be Used As Input When ULP Oscillator Is Disabled**

1. **Port Pin Should Not Be Used As Input When ULP Oscillator Is Disabled**

Port pin PB3 is not guaranteed to perform as a reliable input when the Ultra Low Power (ULP) oscillator is not running. In addition, the pin is pulled down internally when ULP oscillator is disabled.

Problem Fix / Workaround

The ULP oscillator is automatically activated when required. To use PB3 as an input, activate the watchdog timer. The watchdog timer automatically enables the ULP oscillator.

9.1.2 Rev. B

- **Port Pin Should Not Be Used As Input When ULP Oscillator Is Disabled**

1. **Port Pin Should Not Be Used As Input When ULP Oscillator Is Disabled**

Port pin PB3 is not guaranteed to perform as a reliable input when the Ultra Low Power (ULP) oscillator is not running. In addition, the pin is pulled down internally when ULP oscillator is disabled.

Problem Fix / Workaround

The ULP oscillator is automatically activated when required. To use PB3 as an input, activate the watchdog timer. The watchdog timer automatically enables the ULP oscillator.

9.1.3 Rev. A

- **Flash / EEPROM Can Not Be Written When Supply Voltage Is Below 2.4V**
- **Port Pin Should Not Be Used As Input When ULP Oscillator Is Disabled**

1. **Flash / EEPROM Can Not Be Written When Supply Voltage Is Below 2.4V**

When supply voltage is below 2.4V write operations to Flash and EEPROM may fail.

Problem Fix / Workaround

Do not write to Flash or EEPROM when supply voltage is below 2.4V.

2. **Port Pin Should Not Be Used As Input When ULP Oscillator Is Disabled**

Port pin PB3 is not guaranteed to perform as a reliable input when the Ultra Low Power (ULP) oscillator is not running. In addition, the pin is pulled down internally when ULP oscillator is disabled.

Problem Fix / Workaround

The ULP oscillator is automatically activated when required. To use PB3 as an input, activate the watchdog timer. The watchdog timer automatically enables the ULP oscillator.



Atmel Corporation 1600 Technology Drive, San Jose, CA 95110 USA T: (+1)(408) 441.0311 F: (+1)(408) 436.4200 | www.atmel.com

© 2014 Atmel Corporation. / Rev.: Atmel-8303HS-AVR-ATtiny1634-Summary_02/2014.

Atmel®, Atmel logo and combinations thereof, and others are registered trademarks or trademarks of Atmel Corporation or its subsidiaries. Other terms and product names may be trademarks of others.

DISCLAIMER: The information in this document is provided in connection with Atmel products. No license, express or implied, by estoppel or otherwise, to any intellectual property right is granted by this document or in connection with the sale of Atmel products. EXCEPT AS SET FORTH IN THE ATMEL TERMS AND CONDITIONS OF SALES LOCATED ON THE ATMEL WEBSITE, ATMEL ASSUMES NO LIABILITY WHATSOEVER AND DISCLAIMS ANY EXPRESS, IMPLIED OR STATUTORY WARRANTY RELATING TO ITS PRODUCTS INCLUDING, BUT NOT LIMITED TO, THE IMPLIED WARRANTY OF MERCHANTABILITY, FITNESS FOR A PARTICULAR PURPOSE, OR NON-INFRINGEMENT. IN NO EVENT SHALL ATMEL BE LIABLE FOR ANY DIRECT, INDIRECT, CONSEQUENTIAL, PUNITIVE, SPECIAL OR INCIDENTAL DAMAGES (INCLUDING, WITHOUT LIMITATION, DAMAGES FOR LOSS AND PROFITS, BUSINESS INTERRUPTION, OR LOSS OF INFORMATION) ARISING OUT OF THE USE OR INABILITY TO USE THIS DOCUMENT, EVEN IF ATMEL HAS BEEN ADVISED OF THE POSSIBILITY OF SUCH DAMAGES. Atmel makes no representations or warranties with respect to the accuracy or completeness of the contents of this document and reserves the right to make changes to specifications and products descriptions at any time without notice. Atmel does not make any commitment to update the information contained herein. Unless specifically provided otherwise, Atmel products are not suitable for, and shall not be used in, automotive applications. Atmel products are not intended, authorized, or warranted for use as components in applications intended to support or sustain life.

SAFETY-CRITICAL, MILITARY, AND AUTOMOTIVE APPLICATIONS DISCLAIMER: Atmel products are not designed for and will not be used in connection with any applications where the failure of such products would reasonably be expected to result in significant personal injury or death ("Safety-Critical Applications") without an Atmel officer's specific written consent. Safety-Critical Applications include, without limitation, life support devices and systems, equipment or systems for the operation of nuclear facilities and weapons systems. Atmel products are not designed nor intended for use in military or aerospace applications or environments unless specifically designated by Atmel as military-grade. Atmel products are not designed nor intended for use in automotive applications unless specifically designated by Atmel as automotive-grade.