



SMT inductors

SIMID series, SIMID 1210-H

Series/Type: **B82422H**

Date: February 2020

SMD

Size 1210 (EIA) or 3225 (IEC)
Rated inductance 1 ... 680 μ H
Rated current 61 ... 1150 mA



Construction

- Ferrite drum core
- Laser-welded winding
- Flame-retardant molding

Features

- Temperature range up to +150 °C
- Very high current handling capability
- Qualified to AEC-Q200
- Suitable for lead-free reflow soldering as referenced in JEDEC J-STD 020D
- RoHS-compatible

Applications

- Filtering of supply voltages, coupling, decoupling
- DC/DC converters, switch-mode power supplies
- Automotive electronics (e.g. single wire bus systems)

Terminals

- Base material CuSn6
- Layer composition Cu, Ag, Sn (lead-free)¹⁾
- Electro-plated

Marking

- Marking on component:
 Manufacturer and letter "H", L value (in μ H), tolerance of L value (coded), date of manufacture (YWWD)
- Minimum data on reel:
 Manufacturer, ordering code, L value, quantity, date of packing

Delivery mode and packing units

- 8-mm blister tape, wound on 180-mm or 330-mm \varnothing reel
- Packing units:
 180-mm reel: 2000 pcs./reel
 330-mm reel: 7500 pcs./reel

1) Ni-barrier-plated terminals on request (B82422H*50).

SIMID 1210-H

SMD

Dimensional drawing and layout recommendation

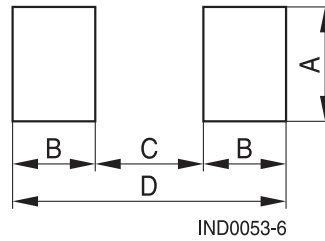
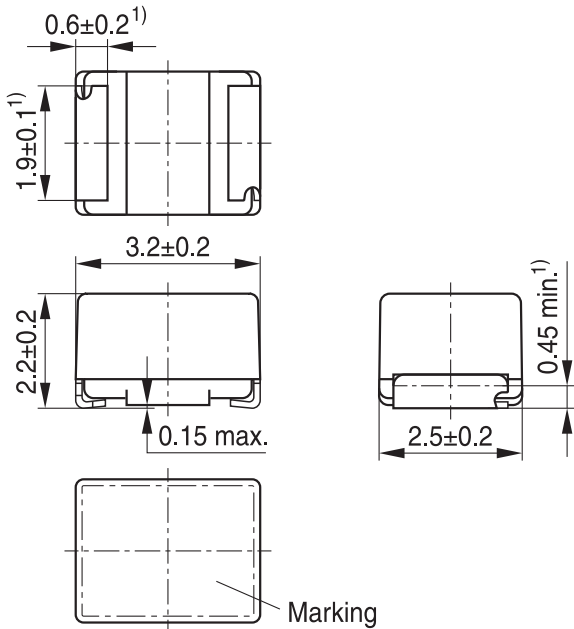

IND0053-6

A	B	C	D
2.7	1.15	2.1	4.4

1) Soldering area

IND0496-P-E

Dimensions in mm

Taping and packing

Blister tape

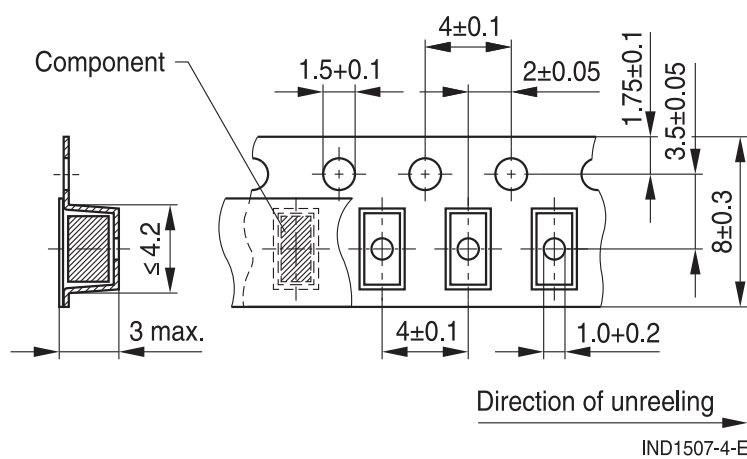

IND1507-4-E

Reel

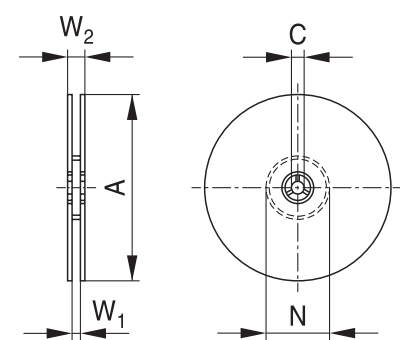

IND1506-3

Dimensions in mm

	180 mm reel	330 mm reel
A	180.0 +0/-3	330.0 ±2.0
C	13.0 +0.5/-0.2	13.0 +0.5/-0.2
N	60.0 ±1.0	75.0 +1.0/-3.0
W₁	8.4 +1.5/-0	8.4 +1.5/-0
W₂	14.4 max	14.4 max

SMD
Technical data and measuring conditions

Rated inductance L_R	Measured with impedance analyzer Agilent 4294A and test fixture Agilent 16034H or equivalent at frequency f_L , RMS voltage 0.1 V, $+(23 \pm 5)^\circ\text{C}$
Q factor Q_{\min}	Measured with impedance analyzer Agilent 4294A and test fixture Agilent 16034H or equivalent at frequency f_Q , RMS voltage 0.1 V, $+(23 \pm 5)^\circ\text{C}$
Rated temperature T_R	$+105^\circ\text{C}$
Rated current I_R	Maximum permissible DC with temperature increase of $\leq 45\text{ K}$ at rated temperature
Saturation current I_{sat}	Maximum permissible DC with inductance decrease $\Delta L/L_0$ of approx. 30% at $+(23 \pm 5)^\circ\text{C}$
Self-resonance frequency $f_{\text{res,min}}$	Measured with impedance analyzer Agilent 4294A / E4991A or equivalent at $+(23 \pm 5)^\circ\text{C}$
DC resistance R_{max}	Measured with Burster Resitomat 2329 at $+(23 \pm 5)^\circ\text{C}$
Solderability (lead-free)	Sn95.5Ag3.8Cu0.7: $+(245 \pm 5)^\circ\text{C}$, $(5 \pm 0.3)\text{ s}$ Wetting of soldering area $\geq 90\%$ (based on IEC 60068-2-58)
Resistance to soldering heat	$+260^\circ\text{C}$, 40 s (as referenced in JEDEC J-STD 020D)
Climatic category	55/150/56 (to IEC 60068-1)
Storage conditions	Mounted: $-55^\circ\text{C} \dots +150^\circ\text{C}$ Packaged: $-25^\circ\text{C} \dots +40^\circ\text{C}$, $\leq 75\% \text{ RH}$
Weight	Approx. 50 mg

SMD
Characteristics and ordering codes

L_R μH	Tolerance	f_L, f_Q MHz	Q_{\min}	$I_{\text{sat,typ}}$ mA	$I_{\text{sat,min}}$ mA	I_R mA	R_{\max} Ω	$f_{\text{res,min}}$ MHz	Ordering code ¹⁾²⁾ (\varnothing 180-mm reel)
1.0	$\pm 10\%$	7.96	8	1835	1620	1150	0.10	150	B82422H1102K000
1.5		7.96	8	1520	1375	960	0.13	110	B82422H1152K000
2.2		7.96	8	1350	1220	890	0.15	90	B82422H1222K000
3.3		7.96	8	1150	1040	790	0.18	70	B82422H1332K000
4.7		7.96	8	905	815	700	0.27	46	B82422H1472K000
6.8		7.96	8	770	690	580	0.35	35	B82422H1682K000
10		$\pm 5\% \triangleq J$	2.52	12	620	560	500	0.48	30
15	$\pm 10\% \triangleq K$	2.52	12	535	480	390	0.72	26	B82422H1153+000
22		2.52	12	440	390	340	1.0	21	B82422H1223+000
33	$\pm 10\% \triangleq K$	2.52	12	340	300	280	1.5	15	B82422H1333+000
47		2.52	12	295	265	230	2.1	12	B82422H1473+000
68		2.52	12	250	225	190	3.2	10	B82422H1683+000
100	$\pm 10\% \triangleq K$	0.796	15	195	170	150	4.6	8.0	B82422H1104+000
150		0.796	15	165	140	130	7.0	6.0	B82422H1154+000
220		0.796	15	140	120	110	10.0	5.5	B82422H1224+000
330		0.796	15	115	100	90	14.0	4.5	B82422H1334+000
470		0.796	15	100	85	76	20.0	3.5	B82422H1474+000
680		0.796	15	75	65	61	30.0	3.0	B82422H1684+000

Intermediate values and closer tolerances on request.

Higher currents possible at temperatures $<T_R$ on request.

Sample kit available. Ordering code: B82422X002

For more information refer to chapter "Sample kits".

1) Replace the + by the code letter for the required inductance tolerance.

For reel size \varnothing 330 mm the last digit has to be an »8«. Example: B82422H1102K008

2) For Ni-barrier-plated terminals replace the last two digits "00" by "50" (reel 180 mm) or "58" (reel 330 mm).

SIMID 1210-H

SMD

Impedance $|Z|$ versus frequency f
measured with impedance analyzer Agilent E4991A, typical values at +20 °C

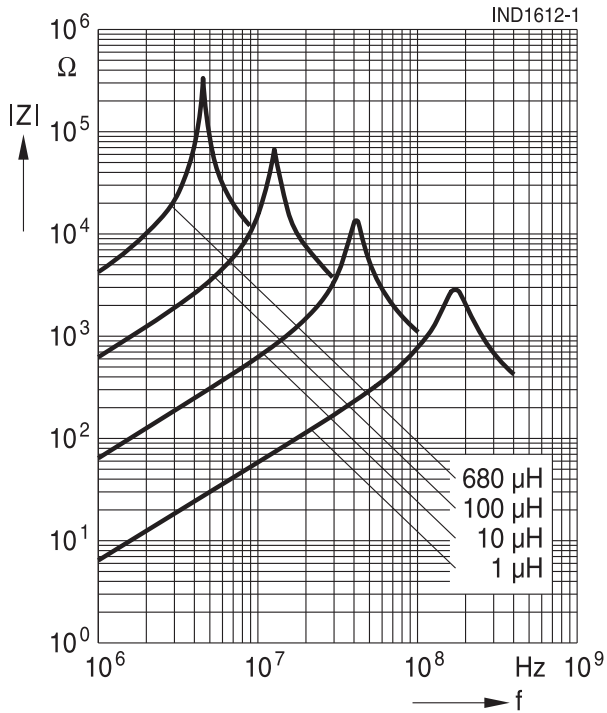

Inductance L versus DC load current I_{DC}
measured with LCR meter Agilent 4285A, typical values at +20 °C

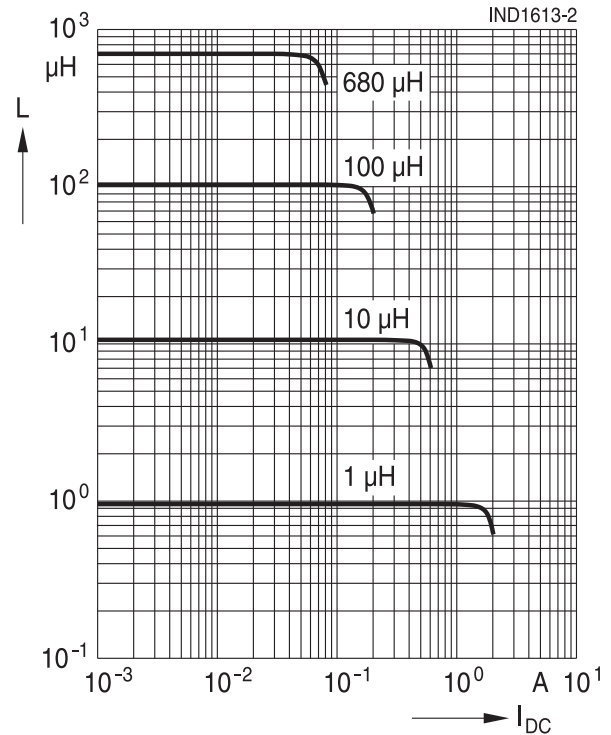

Q factor versus frequency f
measured with impedance analyzer Agilent 4294A, typical values at +20 °C

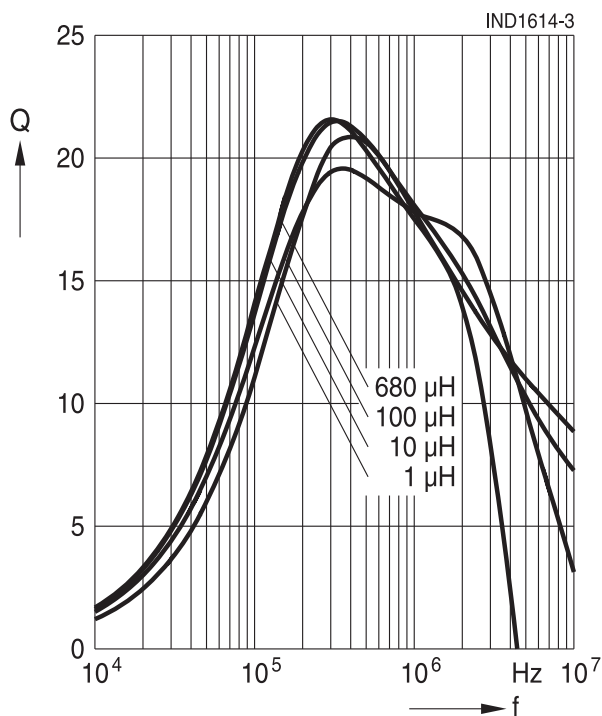

Current derating I_{op}/I_R versus ambient temperature T_A
(rated temperature $T_R = +105$ °C)

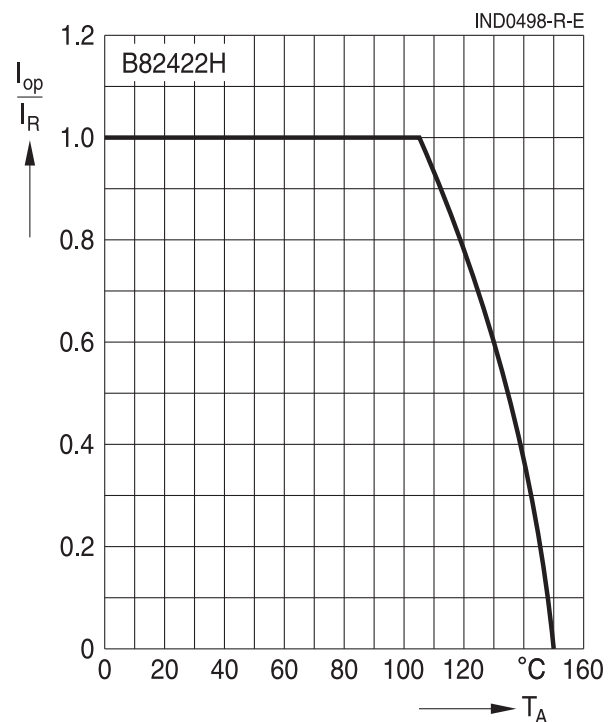

Cautions and warnings

- Please note the recommendations in our Inductors data book (latest edition) and in the data sheets.
 - Particular attention should be paid to the derating curves given there.
 - The soldering conditions should also be observed. Temperatures quoted in relation to wave soldering refer to the pin, not the housing.
- If the components are to be washed varnished it is necessary to check whether the washing varnish agent that is used has a negative effect on the wire insulation, any plastics that are used, or on glued joints. In particular, it is possible for washing varnish agent residues to have a negative effect in the long-term on wire insulation.
Washing processes may damage the product due to the possible static or cyclic mechanical loads (e.g. ultrasonic cleaning). They may cause cracks to develop on the product and its parts, which might lead to reduced reliability or lifetime.
- The following points must be observed if the components are potted in customer applications:
 - Many potting materials shrink as they harden. They therefore exert a pressure on the plastic housing or core. This pressure can have a deleterious effect on electrical properties, and in extreme cases can damage the core or plastic housing mechanically.
 - It is necessary to check whether the potting material used attacks or destroys the wire, wire insulation, plastics or glue.
 - The effect of the potting material can change the high-frequency behaviour of the components.
 - Many coating materials have a negative effect (chemically and mechanically) on the winding wires, insulation materials and connecting points. Customers are always obligated to determine whether and to what extent their coating materials influence the component.
Customers are responsible and bear all risk for the use of the coating material. TDK Electronics does not assume any liability for failures of our components that are caused by the coating material.
- Ceramics / Ferrites are sensitive to direct impact. This can cause the core material to flake, or lead to breakage of the core.
- Even for customer-specific products, conclusive validation of the component in the circuit can only be carried out by the customer.

Display of ordering codes for TDK Electronics products

The ordering code for one and the same product can be represented differently in data sheets, data books, other publications, on the company website, or in order-related documents such as shipping notes, order confirmations and product labels. **The varying representations of the ordering codes are due to different processes employed and do not affect the specifications of the respective products.** Detailed information can be found on the Internet under www.tdk-electronics.tdk.com/orderingcodes.

Important notes

The following applies to all products named in this publication:

1. Some parts of this publication contain **statements about the suitability of our products for certain areas of application**. These statements are based on our knowledge of typical requirements that are often placed on our products in the areas of application concerned. We nevertheless expressly point out **that such statements cannot be regarded as binding statements about the suitability of our products for a particular customer application**. As a rule, we are either unfamiliar with individual customer applications or less familiar with them than the customers themselves. For these reasons, it is always ultimately incumbent on the customer to check and decide whether a product with the properties described in the product specification is suitable for use in a particular customer application.
2. We also point out that **in individual cases, a malfunction of electronic components or failure before the end of their usual service life cannot be completely ruled out in the current state of the art, even if they are operated as specified**. In customer applications requiring a very high level of operational safety and especially in customer applications in which the malfunction or failure of an electronic component could endanger human life or health (e.g. in accident prevention or life-saving systems), it must therefore be ensured by means of suitable design of the customer application or other action taken by the customer (e.g. installation of protective circuitry or redundancy) that no injury or damage is sustained by third parties in the event of malfunction or failure of an electronic component.
3. **The warnings, cautions and product-specific notes must be observed.**
4. In order to satisfy certain technical requirements, **some of the products described in this publication may contain substances subject to restrictions in certain jurisdictions (e.g. because they are classed as hazardous)**. Useful information on this will be found in our Material Data Sheets on the Internet (www.tdk-electronics.tdk.com/material). Should you have any more detailed questions, please contact our sales offices.
5. We constantly strive to improve our products. Consequently, **the products described in this publication may change from time to time**. The same is true of the corresponding product specifications. Please check therefore to what extent product descriptions and specifications contained in this publication are still applicable before or when you place an order.
We also **reserve the right to discontinue production and delivery of products**. Consequently, we cannot guarantee that all products named in this publication will always be available. The aforementioned does not apply in the case of individual agreements deviating from the foregoing for customer-specific products.
6. Unless otherwise agreed in individual contracts, **all orders are subject to our General Terms and Conditions of Supply**.

Important notes

7. **Our manufacturing sites serving the automotive business apply the IATF 16949 standard.**
The IATF certifications confirm our compliance with requirements regarding the quality management system in the automotive industry. Referring to customer requirements and customer specific requirements (“CSR”) TDK always has and will continue to have the policy of respecting individual agreements. Even if IATF 16949 may appear to support the acceptance of unilateral requirements, we hereby like to emphasize that **only requirements mutually agreed upon can and will be implemented in our Quality Management System.** For clarification purposes we like to point out that obligations from IATF 16949 shall only become legally binding if individually agreed upon.
8. The trade names EPCOS, CeraCharge, CeraDiode, CeraLink, CeraPad, CeraPlas, CSMP, CTVS, DeltaCap, DigiSiMic, ExoCore, FilterCap, FormFit, LeaXield, MiniBlue, MiniCell, MKD, MKK, MotorCap, PCC, PhaseCap, PhaseCube, PhaseMod, PhiCap, PowerHap, PQSine, PQvar, SIFERRIT, SIFI, SIKOREL, SilverCap, SIMDAD, SiMic, SIMID, SineFormer, SIOV, ThermoFuse, WindCap are **trademarks registered or pending** in Europe and in other countries. Further information will be found on the Internet at www.tdk-electronics.tdk.com/trademarks.

Release 2018-10