



Inductors

RF chokes, LBC+ series

Series/Type: **B82144B2**

Date: April 2015

© EPCOS AG 2015. Reproduction, publication and dissemination of this publication, enclosures hereto and the information contained therein without EPCOS' prior express consent is prohibited.

EPCOS AG is a TDK Group Company.

Inductors

RF chokes, LBC+ series

B82144B2

LBC chokes, radial leaded

Rated inductance 1 μH ... 470 μH

Rated current 600 mA ... 4450 mA

Construction

- Large ferrite drum core
- Winding: enamel copper wire
- Flame-retardant lacquer coating
- Non-lacquered lead wire

Features

- Very high rated current
- High saturation behaviour
- Suitable for wave soldering
- RoHS-compatible

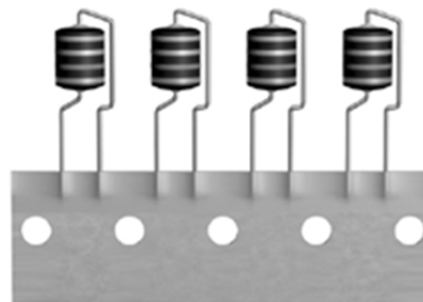

Applications

- DC-DC converters
- Filtering of supply voltage
- RF blocking and filtering
- Decoupling and interference suppression
- For telecommunications, LED and energy-saving lamps, entertainment electronics

Terminals

- Radially bent to 5 mm lead spacing
- Base material CuAg0.1
- Electroplated with nickel and pure tin

Marking

- Inductance indicated by color bands in accordance with IEC 60062

Delivery mode and packing units

- Taped, reel packing
- Packing unit: 1000 pcs/reel

Dimensional drawing

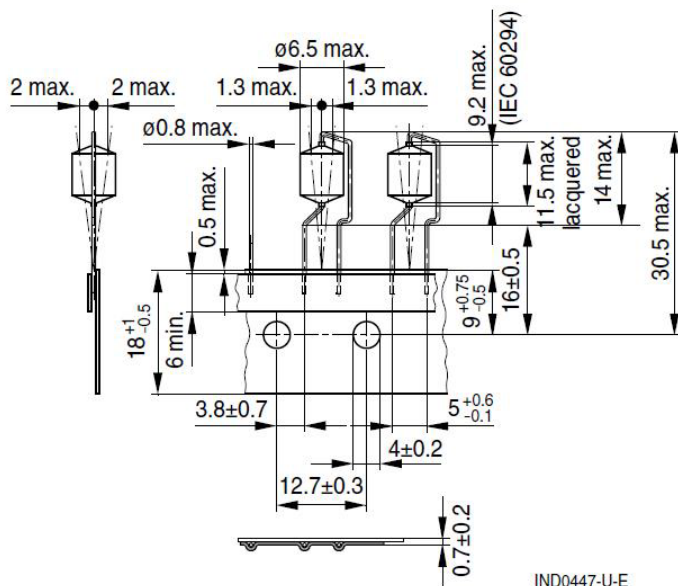

Dimensions in mm

Packing

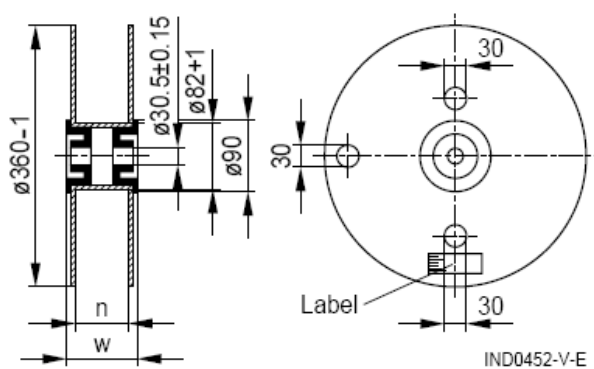

Dimensions in mm

n (mm): 72 +1
w (mm): 84 max

Inductors
RF chokes, LBC+ series
B82144B2
Technical data and measuring conditions

| | |
|--|---|
| Rated inductance L_R | Measured with LCR meter Agilent 4284A or impedance analyzer Agilent 4294A Measuring frequency: $L_R \leq 10 \mu\text{H}$ = 1 MHz $10 \mu\text{H} < L_R \leq 470\mu\text{H}$ = 100 kHz Measuring current: 1 mA Measuring temperature: +20 °C |
| Q factor Q_{\min} | Measured with impedance analyzer Agilent 4294A, +20 °C |
| Rated temperature T_R | +40 °C |
| Rated current I_R | Maximum permissible DC current based on rated temperature of +40 °C and component temperature of max. +125 °C |
| Saturation current I_{sat} | Max. permissible DC with inductance decrease $\Delta L/L_0$ of approx. 10%, at +20 °C |
| DC resistance R_{max} | Measured at +20 °C |
| Resonance frequency $f_{\text{res,min}}$ | Measured with Agilent 4294A or 8753ES, +20 °C |
| Solderability (lead-free) | Sn95.5Ag3.8Cu0.7: (+245 ±5) °C, (3 ±0.3) s Wetting of soldering area: ≥ 90% (to IEC 60068-2-20, test Ta) |
| Resistance to soldering heat | (+260 ±5)°C, 10 s (to IEC 60068-2-20, test Tb) |
| Tensile strength of leads | ≥ 20 N (to IEC 60068-2-21, test Ua) |
| Climatic category | 55/125/56 (to IEC 60068-1) |
| Storage conditions | Mounted: -55 °C ... +125 °C Packaged: -25 °C ... +40 °C, ≤ 75% RH |
| Weight | Approx. 0.95 g |

Mounting information:

When bending the leads, take care that the start-of-winding areas at the face ends (protected by glue and lacquer) are not subjected to any mechanical stress.

Inductors
RF chokes, LBC+ series
B82144B2
Characteristics and ordering codes

| L_R μH | Tolerance | Q_{\min} | f_Q MHz | I_R mA | I_{sat} mA | R_{\max} Ω | $f_{\text{res, min}}$ MHz | Ordering code |
|------------------------|--------------------|------------|--------------|-------------|------------------------|------------------------|------------------------------|-----------------|
| 1.0 | $\pm 10\% \cong K$ | 50 | 2.52 | 4450 | 7700 | 0.043 | 200 | B82144B2102K000 |
| 1.2 | | 60 | 2.52 | 4250 | 7400 | 0.044 | 190 | B82144B2122K000 |
| 1.5 | | 60 | 2.52 | 4100 | 7200 | 0.045 | 170 | B82144B2152K000 |
| 1.8 | | 60 | 2.52 | 3750 | 6400 | 0.050 | 150 | B82144B2182K000 |
| 2.2 | | 60 | 2.52 | 3650 | 6000 | 0.055 | 140 | B82144B2222K000 |
| 2.7 | | 60 | 2.52 | 3550 | 5400 | 0.060 | 120 | B82144B2272K000 |
| 3.3 | | 60 | 2.52 | 3500 | 5000 | 0.065 | 100 | B82144B2332K000 |
| 3.9 | | 60 | 2.52 | 3350 | 4400 | 0.075 | 90 | B82144B2392K000 |
| 4.7 | | 50 | 2.52 | 3050 | 4000 | 0.080 | 70 | B82144B2472K000 |
| 5.6 | | 50 | 2.52 | 2950 | 3750 | 0.090 | 45 | B82144B2562K000 |
| 6.8 | | 50 | 2.52 | 2750 | 3500 | 0.095 | 40 | B82144B2682K000 |
| 8.2 | | 40 | 0.252 | 2650 | 3100 | 0.105 | 28 | B82144B2822K000 |
| 10 | | 40 | 0.252 | 2450 | 2850 | 0.120 | 22 | B82144B2103K000 |
| 12 | | 40 | 0.252 | 2400 | 2650 | 0.130 | 20 | B82144B2123K000 |
| 15 | | 50 | 0.252 | 2300 | 2400 | 0.140 | 13 | B82144B2153K000 |
| 18 | 50 | 0.252 | 2200 | 2250 | 0.155 | 12 | B82144B2183K000 | |
| 22 | 50 | 0.252 | 2100 | 2000 | 0.175 | 10 | B82144B2223K000 | |
| 27 | 40 | 0.252 | 2000 | 1800 | 0.200 | 9.2 | B82144B2273K000 | |
| 33 | $\pm 5\% \cong J$ | 40 | 0.252 | 1900 | 1650 | 0.220 | 9.0 | B82144B2333J000 |
| 39 | | 40 | 0.252 | 1750 | 1500 | 0.250 | 8.5 | B82144B2393J000 |
| 47 | | 40 | 0.252 | 1700 | 1400 | 0.270 | 7.5 | B82144B2473J000 |
| 56 | | 40 | 0.0796 | 1600 | 1300 | 0.310 | 6.8 | B82144B2563J000 |
| 68 | | 40 | 0.0796 | 1500 | 1150 | 0.350 | 6.1 | B82144B2683J000 |
| 82 | | 40 | 0.0796 | 1400 | 1100 | 0.400 | 6.0 | B82144B2823J000 |
| 100 | | 40 | 0.0796 | 1300 | 950 | 0.460 | 5.4 | B82144B2104J000 |

Inductors
RF chokes, LBC+ series
B82144B2

| L_R μH | Tolerance | Q_{\min} | f_Q MHz | I_R mA | I_{sat} mA | R_{\max} Ω | $f_{\text{res, min}}$ MHz | Ordering code |
|------------------------|---------------------|------------|--------------|-------------|------------------------|------------------------|------------------------------|-----------------|
| 120 | $\pm 5\% \hat{=} J$ | 40 | 0.0796 | 1100 | 850 | 0.600 | 4.6 | B82144B2124J000 |
| 150 | | 40 | 0.0796 | 1050 | 750 | 0.700 | 4.2 | B82144B2154J000 |
| 180 | | 40 | 0.0796 | 950 | 720 | 0.785 | 4.0 | B82144B2184J000 |
| 220 | | 40 | 0.0796 | 900 | 650 | 1.010 | 3.6 | B82144B2224J000 |
| 270 | | 40 | 0.0796 | 800 | 580 | 1.200 | 3.2 | B82144B2274J000 |
| 330 | | 40 | 0.0796 | 700 | 520 | 1.530 | 2.8 | B82144B2334J000 |
| 390 | | 40 | 0.0796 | 650 | 480 | 1.720 | 2.5 | B82144B2394J000 |
| 470 | | 40 | 0.0796 | 600 | 440 | 2.020 | 2.3 | B82144B2474J000 |

Inductors

RF chokes, LBC+ series

B82144B2

Impedance $|Z|$ versus frequency f

measured with impedance analyzer Agilent 4294A or S-parameter network analyzer Agilent 8753ES, typical values at +20°C

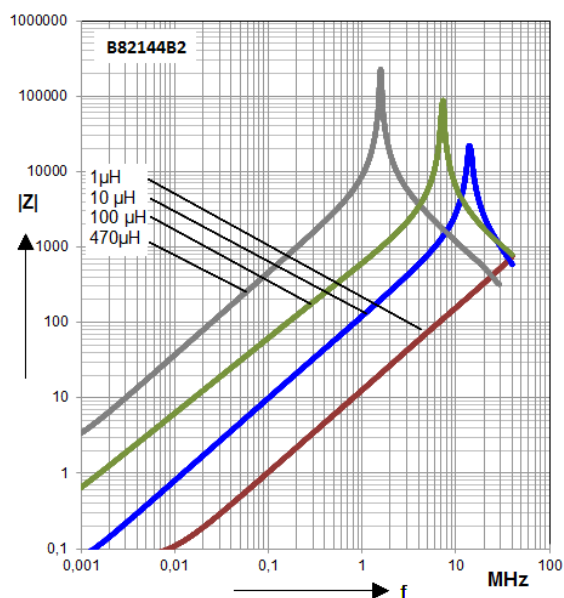

Inductance L versus DC load current I_{DC}

measured with LCR meter Agilent 4284A, typical values at +20°C

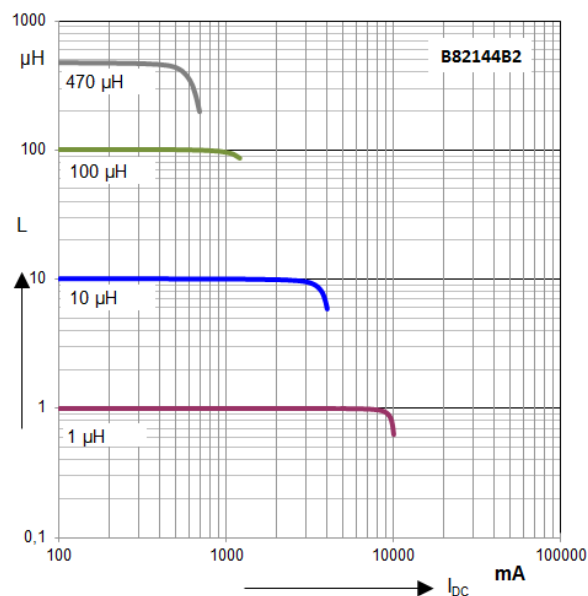

Q factor versus frequency f

measured with impedance analyzer Agilent 4294A, typical values at +20°C

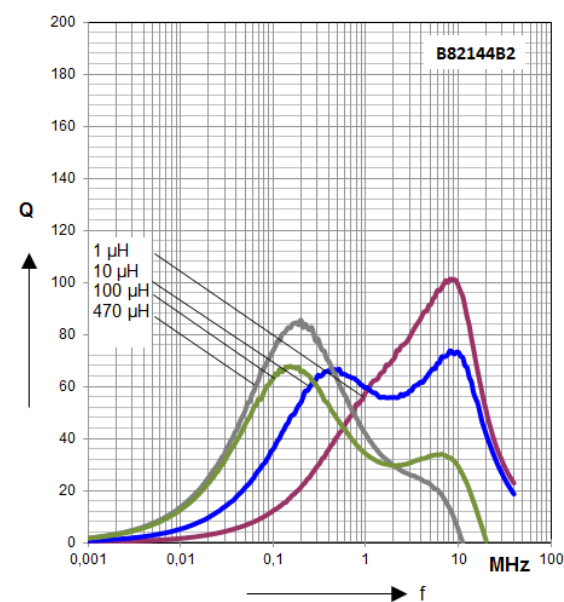

Current derating I_{OP}/I_R versus ambient temperature T_A

(rated temperature $T_R = +40^\circ\text{C}$)

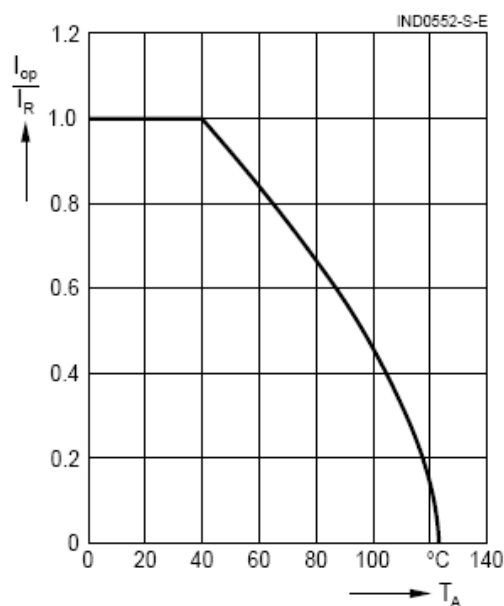

Cautions and warnings

- Please note the recommendations in our Inductors data book (latest edition) and in the data sheets.
 - Particular attention should be paid to the derating curves given there.
 - The soldering conditions should also be observed. Temperatures quoted in relation to wave soldering refer to the pin, not the housing.
- If the components are to be washed varnished it is necessary to check whether the washing varnish agent that is used has a negative effect on the wire insulation, any plastics that are used, or on glued joints. In particular, it is possible for washing varnish agent residues to have a negative effect in the long-term on wire insulation. Washing processes may damage the product due to the possible static or cyclic mechanical loads (e.g. ultrasonic cleaning). They may cause cracks to develop on the product and its parts, which might lead to reduced reliability or lifetime.
- The following points must be observed if the components are potted in customer applications:
 - Many potting materials shrink as they harden. They therefore exert a pressure on the plastic housing or core. This pressure can have a deleterious effect on electrical properties, and in extreme cases can damage the core or plastic housing mechanically.
 - It is necessary to check whether the potting material used attacks or destroys the wire insulation, plastics or glue.
 - The effect of the potting material can change the high-frequency behaviour of the components.
- Ferrites are sensitive to direct impact. This can cause the core material to flake, or lead to breakage of the core.
- Even for customer-specific products, conclusive validation of the component in the circuit can only be carried out by the customer.

Display of ordering codes for EPCOS products

The ordering code for one and the same product can be represented differently in data sheets, data books, other publications and the website of EPCOS, or in order-related documents such as shipping notes, order confirmations and product labels. **The varying representations of the ordering codes are due to different processes employed and do not affect the specifications of the respective products.** Detailed information can be found on the Internet under www.epcos.com/orderingcodes.

Important notes

The following applies to all products named in this publication:

1. Some parts of this publication contain **statements about the suitability of our products for certain areas of application**. These statements are based on our knowledge of typical requirements that are often placed on our products in the areas of application concerned. We nevertheless expressly point out **that such statements cannot be regarded as binding statements about the suitability of our products for a particular customer application**. As a rule we are either unfamiliar with individual customer applications or less familiar with them than the customers themselves. For these reasons, it is always ultimately incumbent on the customer to check and decide whether a product with the properties described in the product specification is suitable for use in a particular customer application.
2. We also point out that **in individual cases, a malfunction of electronic components or failure before the end of their usual service life cannot be completely ruled out in the current state of the art, even if they are operated as specified**. In customer applications requiring a very high level of operational safety and especially in customer applications in which the malfunction or failure of an electronic component could endanger human life or health (e.g. in accident prevention or life-saving systems), it must therefore be ensured by means of suitable design of the customer application or other action taken by the customer (e.g. installation of protective circuitry or redundancy) that no injury or damage is sustained by third parties in the event of malfunction or failure of an electronic component.
3. **The warnings, cautions and product-specific notes must be observed.**
4. In order to satisfy certain technical requirements, **some of the products described in this publication may contain substances subject to restrictions in certain jurisdictions (e.g. because they are classed as hazardous)**. Useful information on this will be found in our Material Data Sheets on the Internet (www.tdk-electronics.tdk.com/material). Should you have any more detailed questions, please contact our sales offices.
5. We constantly strive to improve our products. Consequently, **the products described in this publication may change from time to time**. The same is true of the corresponding product specifications. Please check therefore to what extent product descriptions and specifications contained in this publication are still applicable before or when you place an order.

We also **reserve the right to discontinue production and delivery of products**. Consequently, we cannot guarantee that all products named in this publication will always be available. The aforementioned does not apply in the case of individual agreements deviating from the foregoing for customer-specific products.
6. Unless otherwise agreed in individual contracts, **all orders are subject to our General Terms and Conditions of Supply**.
7. **Our manufacturing sites serving the automotive business apply the IATF 16949 standard**. The IATF certifications confirm our compliance with requirements regarding the quality management system in the automotive industry. Referring to customer requirements and customer specific requirements ("CSR") TDK always has and will continue to have the policy of respecting individual agreements. Even if IATF 16949 may appear to support the acceptance of unilateral requirements, we hereby like to emphasize that **only requirements mutually agreed upon can and will be implemented in our Quality Management System**. For clarification purposes we like to point out that obligations from IATF 16949 shall only become legally binding if individually agreed upon.
8. The trade names EPCOS, CeraCharge, CeraDiode, CeraLink, CeraPad, CeraPlas, CSMP, CTVS, DeltaCap, DigiSiMic, ExoCore, FilterCap, FormFit, LeaXield, MiniBlue, MiniCell, MKD, MKK, MotorCap, PCC, PhaseCap, PhaseCube, PhaseMod, PhiCap, PowerHap, PQSine, PQvar, SIFERRIT, SIFI, SIKOREL, SilverCap, SIMDAD, SiMic, SIMID, SineFormer, SIOV, ThermoFuse, WindCap are **trademarks registered or pending** in Europe and in other countries. Further information will be found on the Internet at www.tdk-electronics.tdk.com/trademarks.

Release 2018-10