

### Features

- 1 Hz to 2.5 MHz  $\pm$ 5 ppm all-inclusive frequency stability
- Factory programmable output frequency
- World's smallest TCXO Footprint: 1.2 mm<sup>2</sup>
  - 1.5 x 0.8 mm CSP
  - No external bypass cap required
- Improved stability reduces system power with fewer network timekeeping updates
- Ultra-low power: 6  $\mu$ A (100 kHz)
- Supply voltage range: 1.62 V to 3.63 V
- Operating temperature ranges: -20°C to +70°C, -40°C to +85°C
- Pb-free, RoHS and REACH compliant

### Applications

- Health and wellness monitors
- Smart pens
- ULP input devices
- Proprietary wireless
- Sensor interface



### Electrical Specifications

**Table 1. Electrical Characteristics**

Conditions: Min/Max limits are over temperature,  $V_{DD} = 1.8V \pm 10\%$ , unless otherwise stated. Typicals are at 25°C and  $V_{DD} = 1.8V$ .

Parameter	Symbol	Min.	Typ.	Max.	Unit	Condition
<b>Frequency and Stability</b>						
Output Frequency	$F_{OUT}$	1		2.5 M	Hz	
Total Frequency Stability <sup>[1]</sup>	$F_{stab}$	-5		5	ppm	All inclusive, Stability code: E
		-20		20	ppm	All inclusive, Stability code: 1
Allan Deviation	AD		1e-8	4e-8		1 second averaging time
First Year Frequency Aging	$F_{aging}$		$\pm 1$		ppm	$T_A = 25^\circ C, V_{DD} = 1.8V$
<b>Jitter Performance</b>						
Integrated Phase Jitter	IPJ		2	3.5	nSRMS	$F_{OUT} > 1$ kHz, Integration bandwidth = 100 Hz to $F_{OUT}/2$ . Inclusive of 50 mV peak-to-peak sinusoidal noise on $V_{DD}$ . Noise frequency 100 Hz to 20 MHz
Period Jitter	PJ		2.2	4.5	nSRMS	Cycles = 10,000, $f = 100$ kHz. Per JEDEC standard 65B, tested at 100 kHz. See performance plot for other frequencies.
Peak-to-Peak Period Jitter	$PJ_{p-p}$		20	35	ns <sub>p-p</sub>	
<b>Supply Voltage and Current Consumption</b>						
Operating Supply Voltage	$V_{DD}$	1.62		3.63	V	
No Load Supply Current	$I_{DD}$		3.65	5	$\mu A$	$F_{OUT} = 1$ Hz
			4.5	5.5		$F_{OUT} = 33$ kHz
			6	7		$F_{OUT} = 100$ kHz
			13	16		$F_{OUT} = 1$ MHz
			33	40		$F_{OUT} = 2$ MHz
Start-up Time at Power-up	$t_{start}$		150	300	ms	$F_{OUT} > 200$ Hz. Measured when supply reaches 90% of final $V_{DD}$ to the first output pulse and within specified min/max frequency limit.
			300 + 2.0 cycles	300 + 2.5 cycles		10 Hz < $F_{OUT} \leq 200$ Hz. Measured when supply reaches 90% of final $V_{DD}$ to the first output pulse and within specified min/max frequency limit.
				500 + 2.5 Cycles		1 Hz $\leq F_{OUT} \leq 10$ Hz. Measured when supply reaches 90% of final $V_{DD}$ to the first output pulse and within specified min/max frequency limit.
<b>Operating Temperature Range</b>						
Operating Temperature Range	Op_Temp	-20		70	°C	"C" ordering code
		-40		85	°C	"I" ordering code
<b>LVC MOS Output</b>						
Output Rise/Fall Time	$t_R, t_F$		9	20	ns	20-80%, 15 pF load, $V_{DD} = 1.8V \pm 10\%$
Output Clock Duty Cycle	DC	45		55	%	
Output Voltage High	$V_{OH}$	90%			$V_{DD}$	$I_{OH} = -50 \mu A, 15$ pF load
Output Voltage Low	$V_{OL}$			10%	$V_{DD}$	$I_{OL} = 50 \mu A, 15$ pF load

**Note:**

1. Includes initial tolerance, over temp stability, 2x reflow,  $V_{DD}$  range, board-level under fill, and 20% load variation. Tested with Agilent 53132A frequency counter. Measured with  $\geq 100$  ms gate time for accurate frequency measurement.

**Table 2. Pin Configuration**

Pin	Symbol	I/O	Functionality
1	NC	Internal Test	No Connect. Leave floating. Pin 1 is for internal testing and is designed to be left floating.
2	CLK Out	OUT	Oscillator clock output.
3	Vdd	Power Supply	Operates from nominal supply voltages between 1.8V and 3.3V. Under normal operating conditions, Vdd does not require external bypass/decoupling capacitor(s). SiT1576 includes on-chip Vdd filtering.
4	GND	Power Supply Ground	Connect to ground.

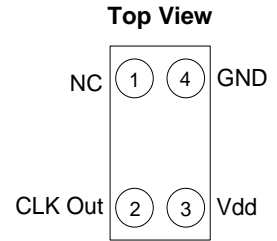

**Figure 1. Pin Assignment**

**Table 3. Absolute Maximum Ratings**

Attempted operation outside the absolute maximum ratings may cause permanent damage to the part. Actual performance of the IC is only guaranteed within the operational specifications, not at absolute maximum ratings.

Parameters	Test Conditions	Value	Unit
Continuous Power Supply Voltage Range (Vdd)		-0.5 to 4.0	V
Continuous Maximum Operating Temperature Range		105	°C
Short Duration Maximum Operating Temperature Range	≤ 30 minutes	125	°C
Human Body Model (HBM) ESD Protection	JESD22-A114	2000	V
Charge-Device Model (CDM) ESD Protection	JESD22-C101	750	V
Machine Model (MM) ESD Protection	JESD22-A115	300	V
Latch-up Tolerance	JESD78 Compliant		
Mechanical Shock Resistance	Mil 883, Method 2002	20,000	g
Mechanical Vibration Resistance	Mil 883, Method 2007	70	g
1508 CSP Junction Temperature		150	°C
Storage Temperature		-65 to 150	°C

**System Block Diagram**

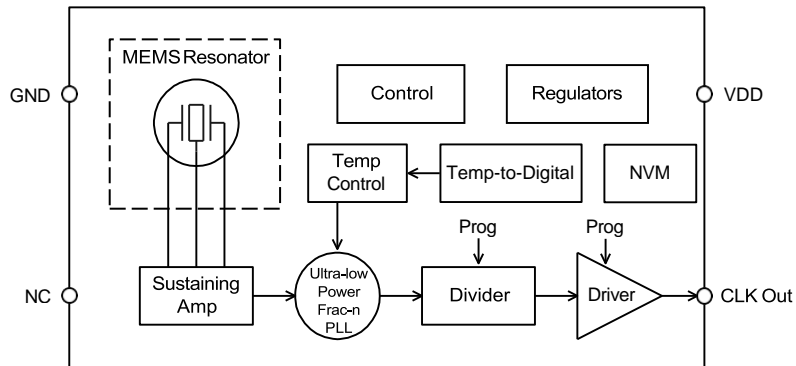

**Figure 2. SiT1576 Block Diagram**

## Description

SiT1576 is an ultra-small and ultra-low power Factory programmable TCXO with an output frequency range between 1 Hz to 2.5 MHz. SiTime's silicon MEMS technology enables the first 1 Hz – 2.5 MHz TCXO in the world's smallest footprint and chip-scale packaging (CSP). Typical supply current is only 6  $\mu$ A (100 kHz).

SiTime's MEMS oscillator consists of a MEMS resonator and a programmable analog circuit. SiT1576 MEMS resonator is built with SiTime's unique MEMS First™ process. A key manufacturing step is EpiSeal™ during which the MEMS resonator is annealed with temperatures over 1000°C. EpiSeal creates an extremely strong, clean, vacuum chamber that encapsulates the MEMS resonator and ensures the best performance and reliability. During EpiSeal, a poly silicon cap is grown on top of the resonator cavity, which eliminates the need for additional cap wafers or other exotic packaging. As a result, SiTime's MEMS resonator die can be used like any other semiconductor die. One unique result of SiTime's MEMS First and EpiSeal manufacturing processes is the capability to integrate SiTime's MEMS die with a SOC, ASIC, microprocessor or analog die within a package to eliminate external timing components and provide a highly integrated, smaller, cheaper solution to the customer.

## TCXO Frequency Stability

SiT1576 is factory calibrated (trimmed) over multiple temperature points to guarantee extremely tight stability over temperature. Unlike quartz crystals that have a classic tuning fork parabola temperature curve with a 25°C turnover point with a 0.04 to 0.06 ppm/°C<sup>2</sup> temperature coefficient, the SiT1576 temperature coefficient is calibrated and corrected over temperature with an active temperature correction circuit. The result is a 32 kHz TCXO with extremely tight frequency variation over the -40°C to +85°C temperature range.

When measuring the output frequency of SiT1576 with a frequency counter, it is important to make sure the counter's gate time is >100 ms. Shorter gate times may lead to inaccurate measurements. Similarly, the gate time will need to increase for frequencies in the 1Hz to 500Hz frequency range.

## Dynamic Temperature Frequency Response

Dynamic Temperature Frequency Response is the rate of frequency change during temperature ramps. This is an important performance metric when the oscillator is mounted near a high power component (e.g. SoC or power management) that may rapidly change the temperature of surrounding components.

For moderate temperature ramp rates (<2°C/sec), the dynamic response is primarily determined by the steady-state frequency vs. temperature of the device. The best dynamic response is obtained from parts which have been trimmed to be flat in frequency over temperature.

For high temperature ramp rates (>5°C/sec), the latency in the temperature compensation loop contributes a larger frequency error, which is dependent on the temperature compensation update rate. This part achieves excellent performance at 3 Hz update rate. This device family supports faster update rates for further reducing dynamic frequency error at the expense of slightly increased current consumption.

### Typical Operating Curves

( $T_A = 25^\circ\text{C}$ ,  $V_{DD} = 1.8\text{V}$ , supply current plots are no load, unless otherwise stated)

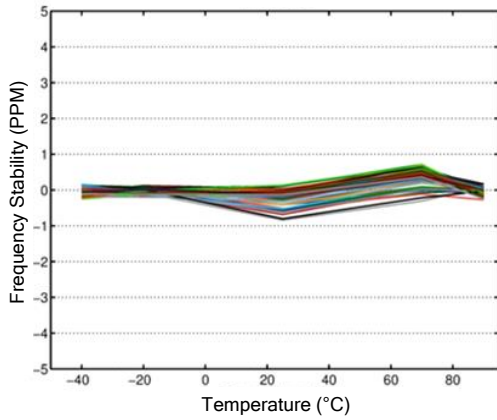

Figure 3. Frequency Stability over Temperature

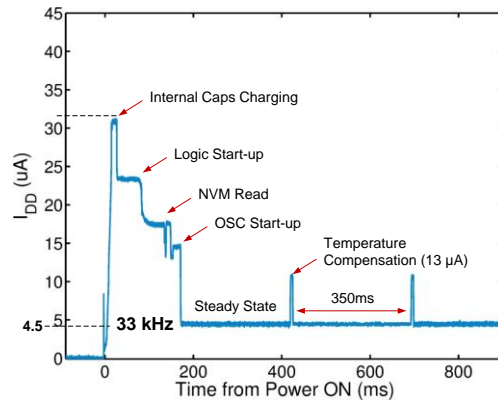

Figure 4. Start-up and Steady-State Current Profile

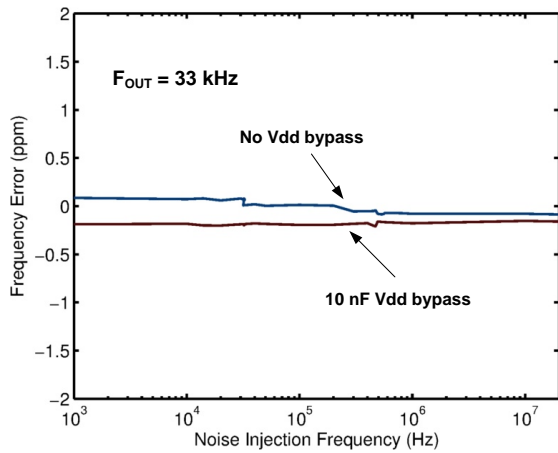

Figure 5. Power Supply Noise Rejection

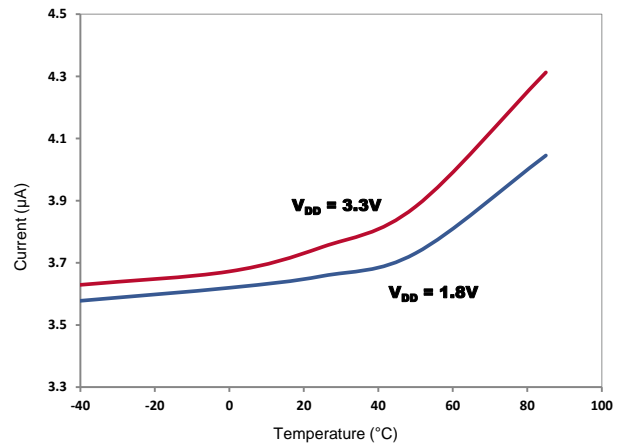

Figure 6. Supply Current vs Temperature ( $F_{OUT} = 1\text{ Hz}$ )

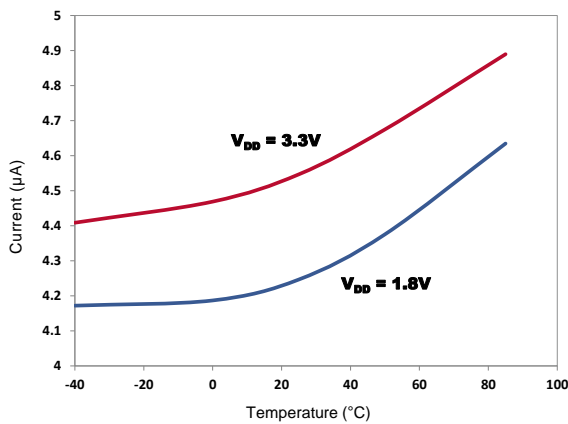

Figure 7. Supply Current vs Temperature ( $F_{OUT} = 100\text{ Hz}$ )

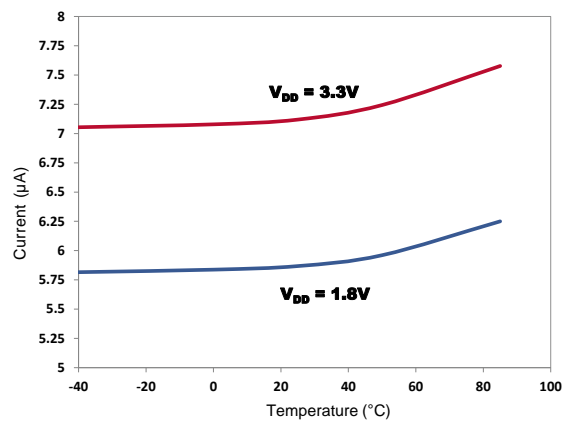

Figure 8. Supply Current vs Temperature ( $F_{OUT} = 100\text{ kHz}$ )

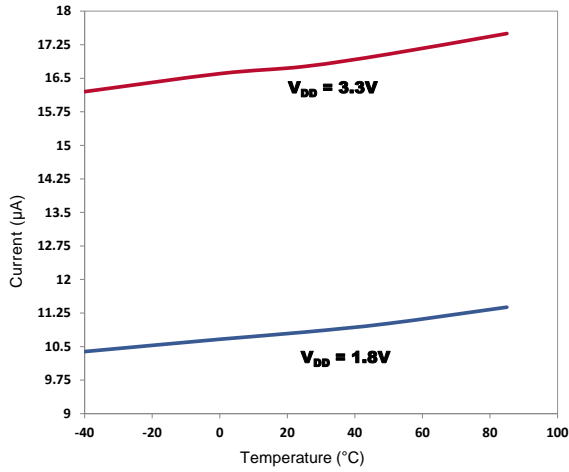

Figure 9. Supply Current vs Temperature (F<sub>OUT</sub> = 500 kHz)

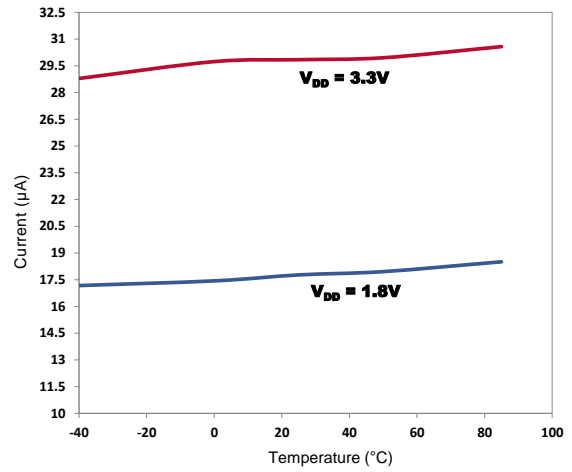

Figure 10. Supply Current vs Temperature (F<sub>OUT</sub> = 1 MHz)

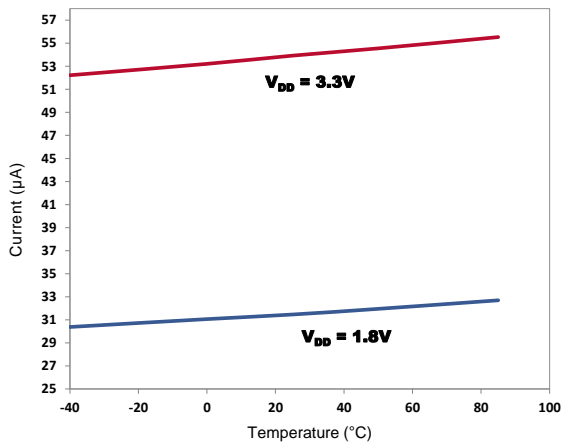

Figure 11. Supply Current vs Temperature (F<sub>OUT</sub> = 1.85 MHz)

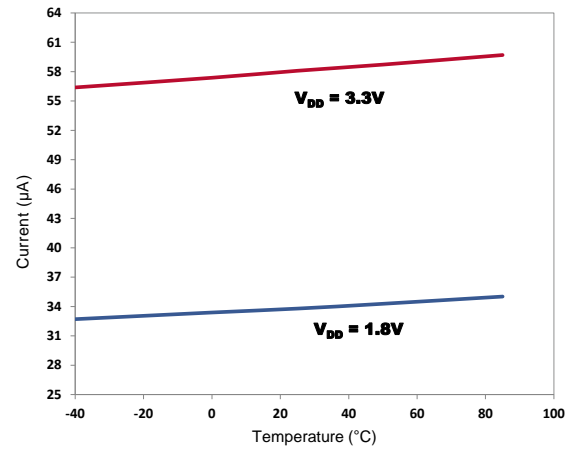
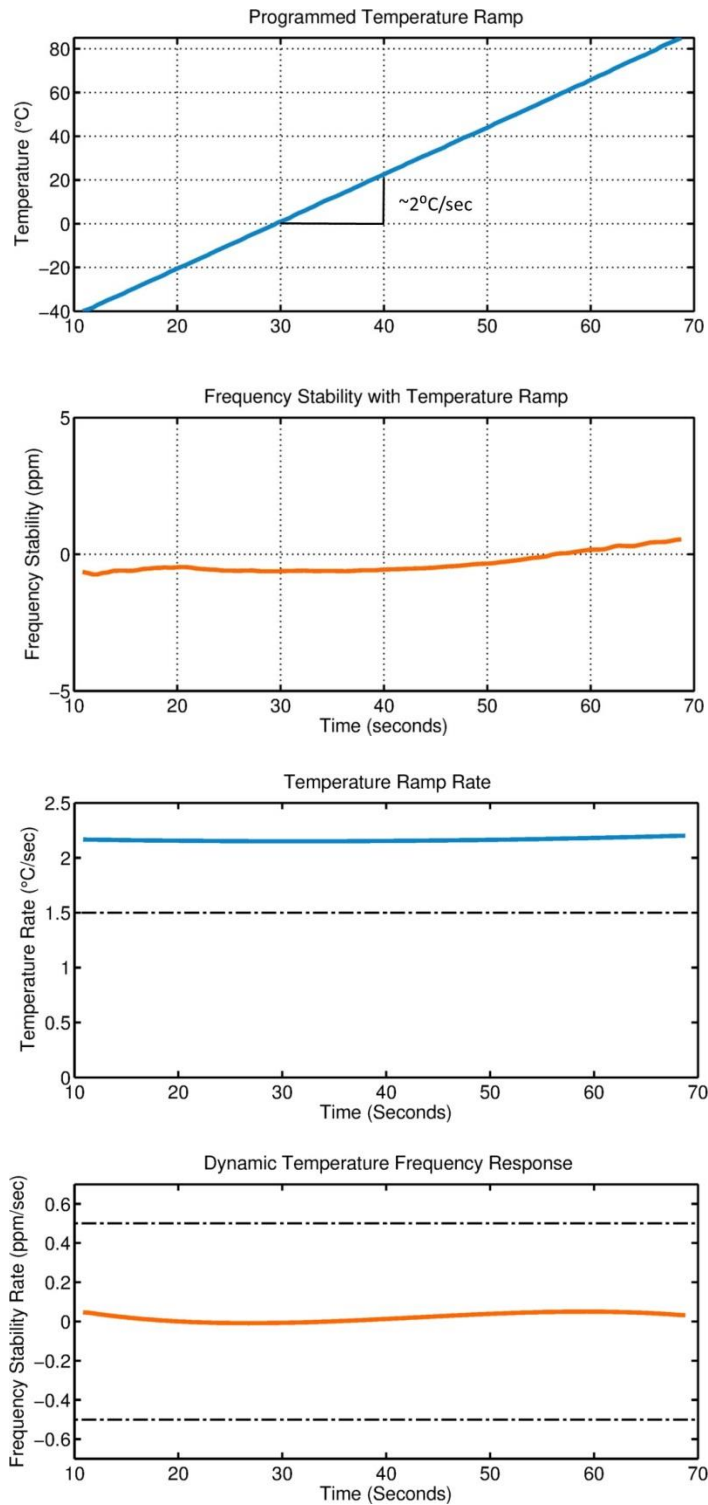

Figure 12. Supply Current vs Temperature (F<sub>OUT</sub> = 2 MHz)

## Dynamic Frequency Response for Moderate Temperature Ramps



Frequency accuracy under a moderate temperature ramp up to  $2^{\circ}\text{C}/\text{sec}$  is limited by the TCXO's trimmed accuracy of the frequency stability over-temperature.

**Note:**

2. Measured relative to 32.768 kHz.

## Dynamic Frequency Response for Fast Temperature Ramps

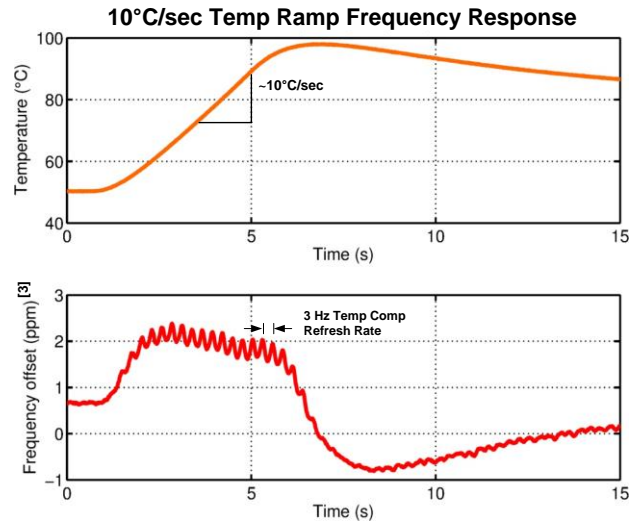
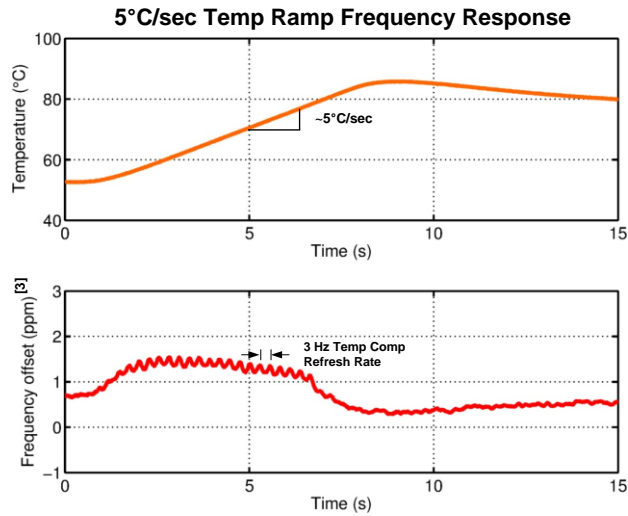

For temperature ramps  $>5^{\circ}\text{C}/\text{sec}$ , the frequency accuracy is limited by the update rate of the temperature compensation path (see the  $5^{\circ}\text{C}/\text{sec}$  and  $10^{\circ}\text{C}/\text{sec}$  plots).

Contact [SiTime](http://www.sitime.com) for applications that require improved dynamic performance.

**Note:**

- 3. Referenced to 32.768 kHz.

## Dimensions and Patterns

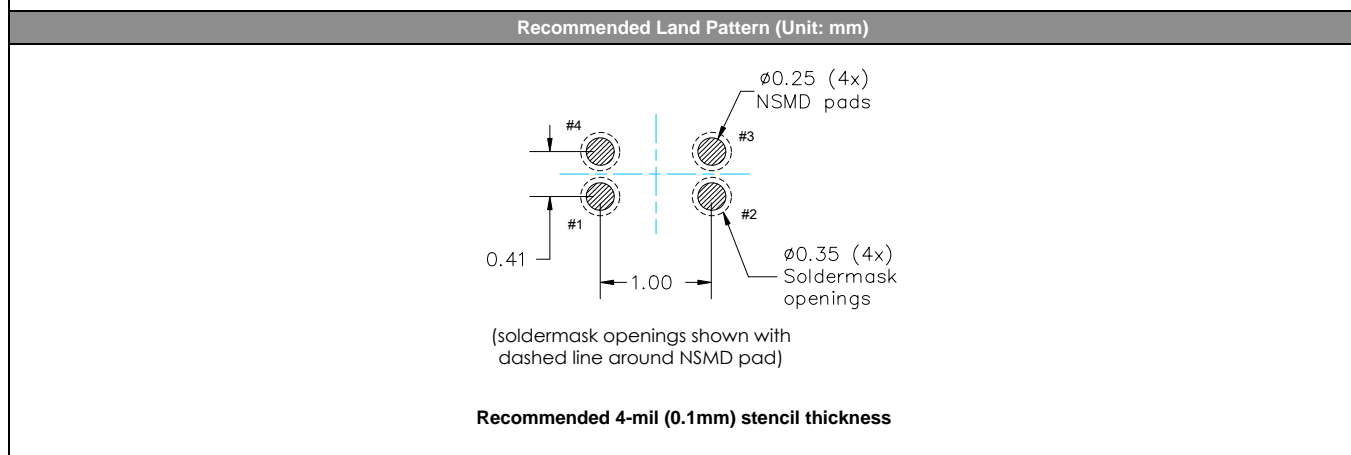
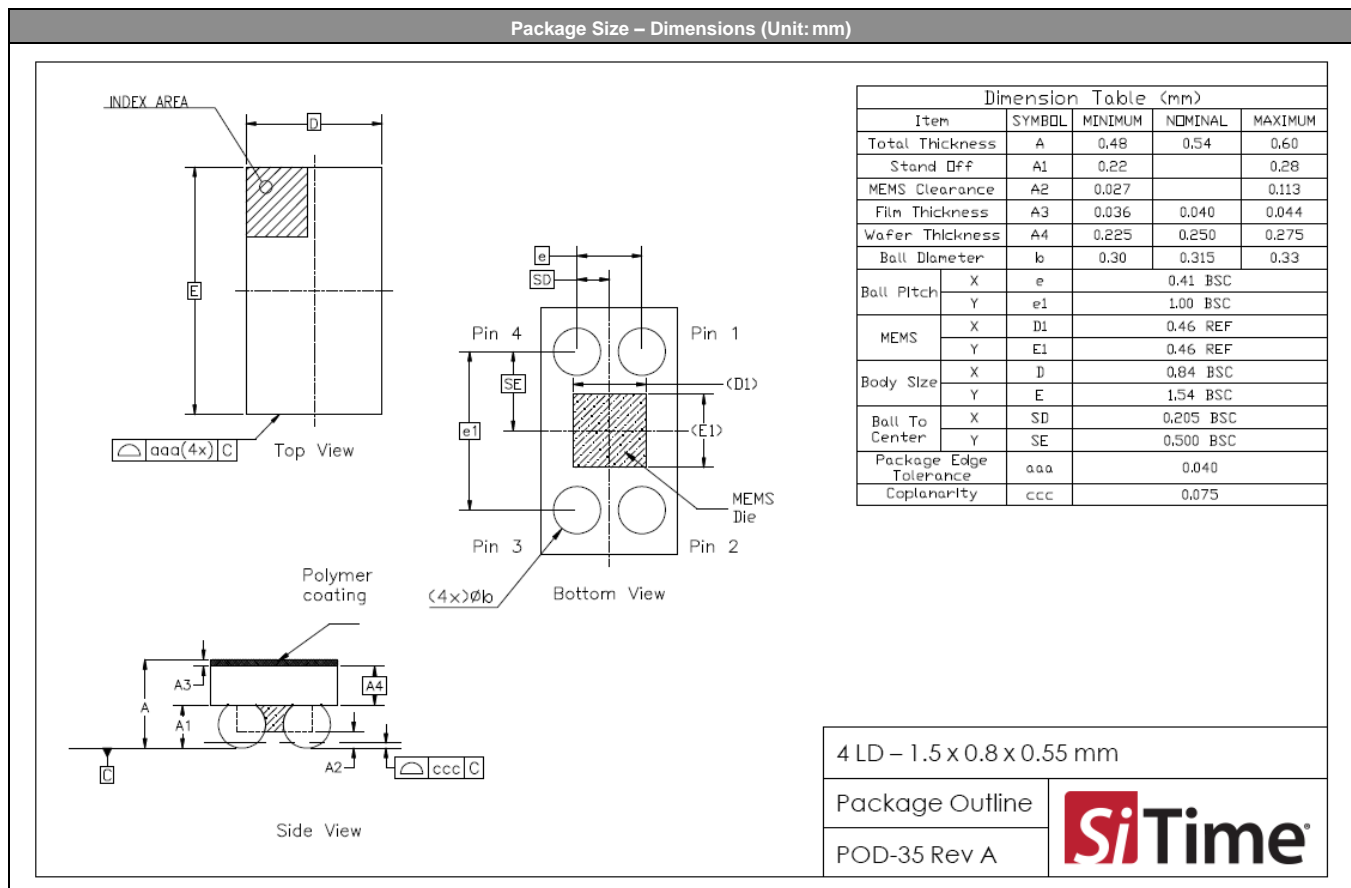

## Manufacturing Guidelines

- 1) No Ultrasonic or Megasonic cleaning: Do not subject SiT1576 to an ultrasonic or megasonic cleaning environment. Permanent damage or long term reliability issues may occur.
- 2) Applying board-level underfill and overmold is acceptable and will not impact the reliability of the device.
- 3) Reflow profile, per JESD22-A113D.
- 4) The SiT1576 CSP includes a protective, opaque polymer top-coat. If the SiT1576 will see intense light, especially in the 1.0-1.2 $\mu$ m IR spectrum, we recommend a protective “glob-top” epoxy or other cover to keep the light from negatively impacting the frequency stability.
- 5) For additional manufacturing guidelines and marking/tape-reel instructions, refer to [SiTime Manufacturing Notes](#).



## Ordering Information

SiT1576AI-JE-XXE-XXXX.XXXXXXQ

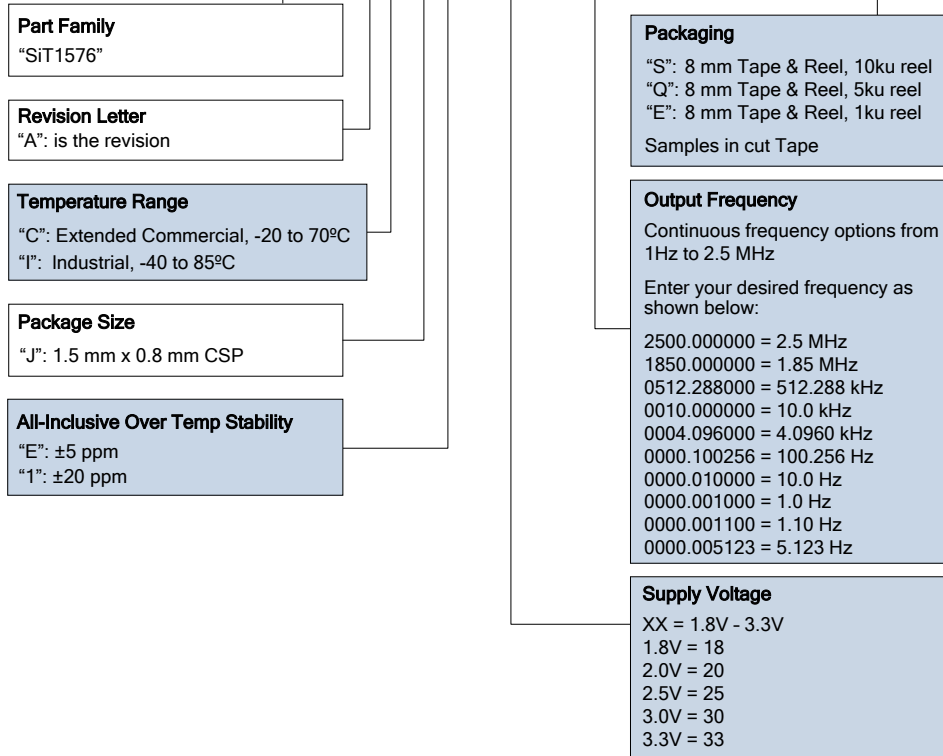

Table 4. Revision History

Version	Release Date	Change Summary
0.25	01/13/2016	Initial Release of Advanced datasheet
0.5	03/10/2016	Preliminary datasheet initial release
0.9	02/15/2017	Updated Package Outline Drawing (POD) Updated part number ordering information Updated max programmable frequency Updated logo and company address, other page layout changes
1.0	05/09/2017	Final Release Updated supply current vs frequency Updated start-up time
1.1	06/12/2017	Updated max operating frequency to 2.0 MHz
1.2	08/03/2017	Added additional typical operating curves Updated typical No Load Supply Current (Table 1)
1.3	03/15/2018	Updated max operating frequency from 2.0MHz to 2.5MHz

SiTime Corporation, 5451 Patrick Henry Drive, Santa Clara, CA 95054, USA | Phone: +1-408-328-4400 | Fax: +1-408-328-4439

© SiTime Corporation 2016-2018. The information contained herein is subject to change at any time without notice. SiTime assumes no responsibility or liability for any loss, damage or defect of a Product which is caused in whole or in part by (i) use of any circuitry other than circuitry embodied in a SiTime product, (ii) misuse or abuse including static discharge, neglect or accident, (iii) unauthorized modification or repairs which have been soldered or altered during assembly and are not capable of being tested by SiTime under its normal test conditions, or (iv) improper installation, storage, handling, warehousing or transportation, or (v) being subjected to unusual physical, thermal, or electrical stress.

**Disclaimer:** SiTime makes no warranty of any kind, express or implied, with regard to this material, and specifically disclaims any and all express or implied warranties, either in fact or by operation of law, statutory or otherwise, including the implied warranties of merchantability and fitness for use or a particular purpose, and any implied warranty arising from course of dealing or usage of trade, as well as any common-law duties relating to accuracy or lack of negligence, with respect to this material, any SiTime product and any product documentation. Products sold by SiTime are not suitable or intended to be used in a life support application or component, to operate nuclear facilities, or in other mission critical applications where human life may be involved or at stake. All sales are made conditioned upon compliance with the critical uses policy set forth below.

**CRITICAL USE EXCLUSION POLICY**

BUYER AGREES NOT TO USE SITIME'S PRODUCTS FOR ANY APPLICATION OR IN ANY COMPONENTS USED IN LIFE SUPPORT DEVICES OR TO OPERATE NUCLEAR FACILITIES OR FOR USE IN OTHER MISSION-CRITICAL APPLICATIONS OR COMPONENTS WHERE HUMAN LIFE OR PROPERTY MAY BE AT STAKE.

SiTime owns all rights, title and interest to the intellectual property related to SiTime's products, including any software, firmware, copyright, patent, or trademark. The sale of SiTime products does not convey or imply any license under patent or other rights. SiTime retains the copyright and trademark rights in all documents, catalogs and plans supplied pursuant to or ancillary to the sale of products or services by SiTime. Unless otherwise agreed to in writing by SiTime, any reproduction, modification, translation, compilation, or representation of this material shall be strictly prohibited.