

PROTECTION PRODUCTS - RailClamp®

Description

RClamp®0516P provides ESD protection for high-speed data interfaces. It features a maximum ESD withstand voltage of $\pm 15\text{kV}$ contact and $\pm 15\text{kV}$ air discharge per IEC 61000-4-2. RClamp0516P is designed to minimize both the ESD peak clamping and the TLP clamping. Package inductance is reduced at each pin resulting in lower peak ESD clamping voltage. The dynamic resistance is extremely low at 0.20 Ohms (typical). Maximum capacitance on each line to ground is 0.65pF allowing the RClamp0516P to be used in applications operating in excess of 5GHz without appreciable signal attenuation. Each device will protect up to six lines (three high-speed pairs).

RClamp0516P is in an 8-pin SLP3313P6 package measuring 3.3 x 1.3mm with a nominal height of 0.575mm. The leads have a nominal pin-to-pin pitch of 0.50mm. Flow-through package design simplifies PCB layout and maintains signal integrity on high-speed lines.

The combination of low peak ESD clamping, low dynamic resistance, and innovative package design enables this device to provide the highest level of ESD protection for applications such as USB 3.0, HDMI 1.4, and MDDI / mipi interfaces.

Features

- ◆ ESD protection for high-speed data lines to **IEC 61000-4-2 (ESD) $\pm 15\text{kV}$ (air), $\pm 15\text{kV}$ (contact)**
- ◆ **IEC 61000-4-5 (Lightning) 4A (8/20 μs)**
- ◆ **IEC 61000-4-4 (EFT) 40A (5/50ns)**
- ◆ Package design optimized for high speed lines
- ◆ Flow-Through design
- ◆ Protects six high-speed lines
- ◆ Low capacitance: **0.65pF** Maximum (I/O to Ground)
- ◆ Low ESD clamping voltage
- ◆ Low dynamic resistance: 0.20 Ohms (Typical)
- ◆ Solid-state silicon-avalanche technology

Mechanical Characteristics

- ◆ SLP3313P6 8-pin package (3.3 x 1.3 x 0.575mm)
- ◆ Pb-Free, Halogen Free, RoHS/WEEE Compliant
- ◆ Lead Pitch: 0.5mm
- ◆ Lead finish: NiPdAu
- ◆ Marking: Marking Code
- ◆ Packaging: Tape and Reel

Applications

- ◆ USB 3.0
- ◆ HDMI 1.4
- ◆ uSD Card Interfaces
- ◆ MMC Card Interfaces
- ◆ MDDI / mipi Interfaces

Circuit Diagram

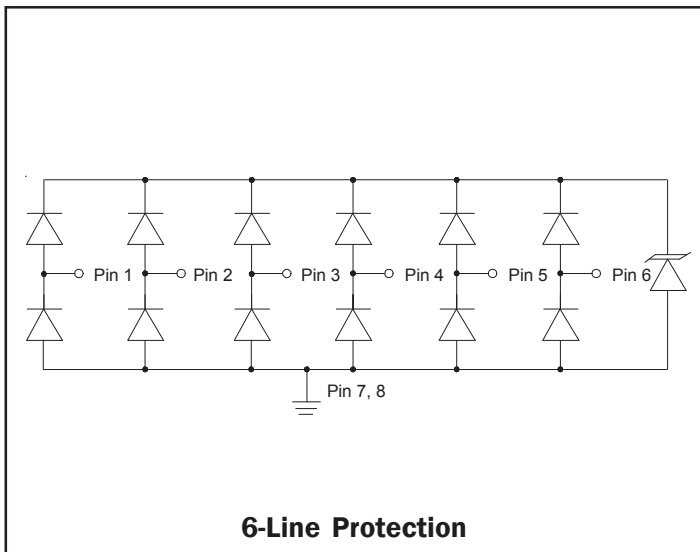

Pin Configuration

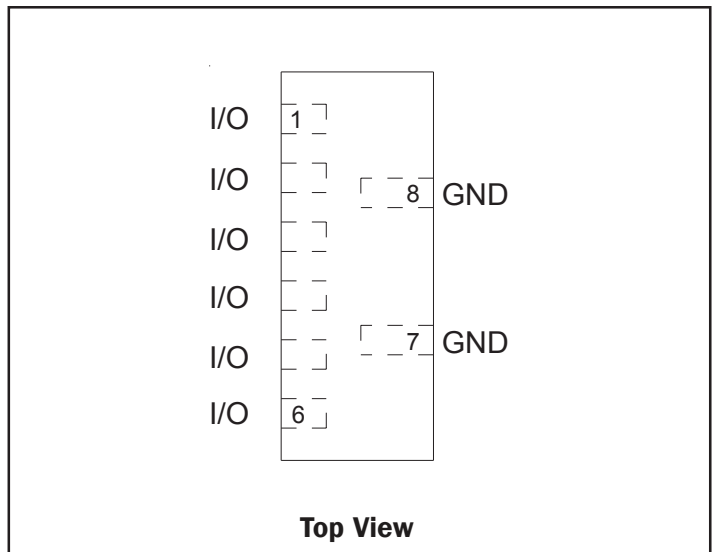

PROTECTION PRODUCTS
Absolute Maximum Rating

Rating	Symbol	Value	Units
Peak Pulse Current ($t_p = 8/20\mu s$) ¹	I_{PP}	4	A
ESD per IEC 61000-4-2 (Air) ² ESD per IEC 61000-4-2 (Contact) ²	V_{ESD}	+/- 15 +/- 15	kV
ESD Per ANSI/ESD/JEDEC JS-001-2011 (HBM)	V_{ESD}	+/- 24	kV
Operating Temperature	T_J	-55 to +125	°C
Storage Temperature	T_{STG}	-55 to +150	°C

Electrical Characteristics (T=25°C)

Parameter	Symbol	Conditions	Minimum	Typical	Maximum	Units
Reverse Stand-Off Voltage	V_{RWM}	Any I/O to GND			5	V
Breakdown Voltage	V_{BR}	$I_{BR} = 10mA$	6.0	8.0	10.0	V
Holding Current ⁵	I_H	$V = V_H$	60	200		mA
Reverse Leakage Current	I_R	$V_{RWM} = 5V, T=25^\circ C$ Any I/O to GND		0.01	0.05	μA
ESD Clamping Voltage ^{3,5}	V_C	$I_{PP} = 4A,$ $t_{lp} = 0.2/100ns$			4	V
ESD Clamping Voltage ^{3,5}	V_C	$I_{PP} = 16A,$ $t_{lp} = 0.2/100ns$			6.5	V
Dynamic Resistance (Positive) ^{3,4,5}	R_D	$t_{lp} = 0.2/100ns$		0.20		Ohms
Junction Capacitance	C_J	$V_R = 0V, f = 1MHz,$ Any I/O to GND		0.62	0.65	pF

Notes

- 1)measured using 1.2/50us, 8/20us combination waveform, 8 Ohm source impedance.
- 2)Measured with a 20dB attenuator, 50 Ohm scope input impedance, 2GHz bandwidth. ESD gun return path connected to ESD ground plane.
- 3)Transmission Line Pulse Test (TLP) Settings: $t_p = 100ns, t_r = 0.2ns, I_{TLP}$ and V_{TLP} averaging window: $t_1 = 70ns$ to $t_2 = 90ns$.
- 4)Dynamic resistance calculated from $I_{TLP} = 4A$ to $I_{TLP} = 16A$
- 5)Guaranteed by design. Not production tested

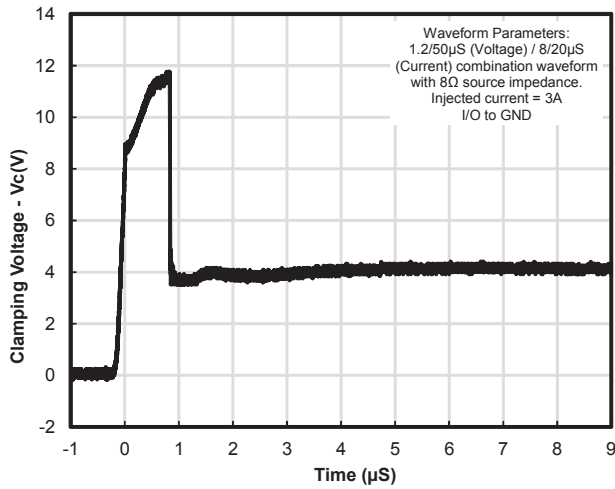
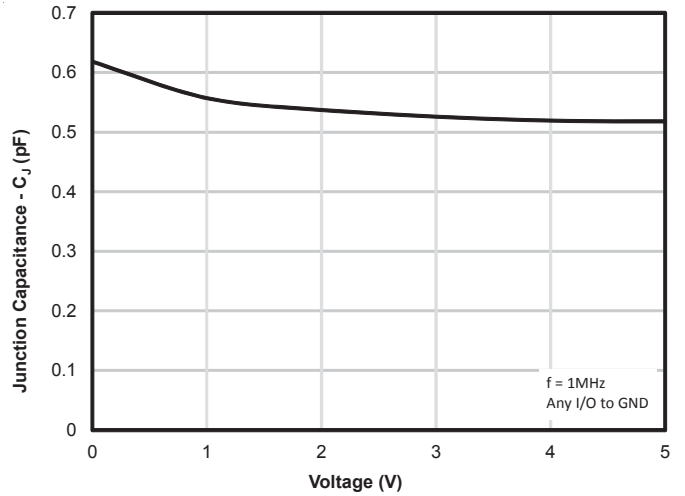
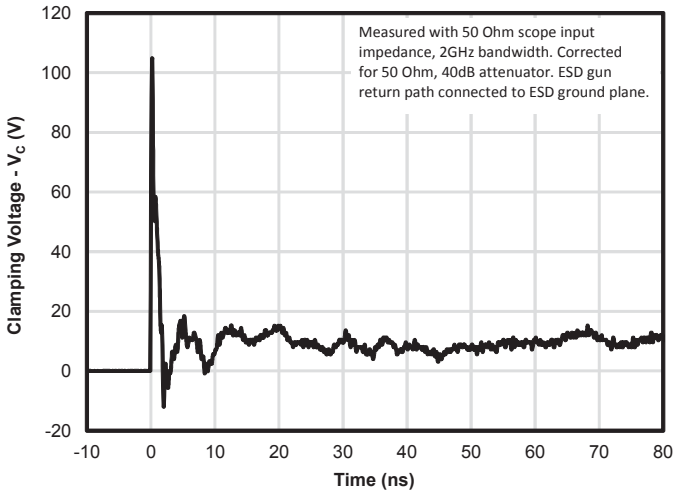
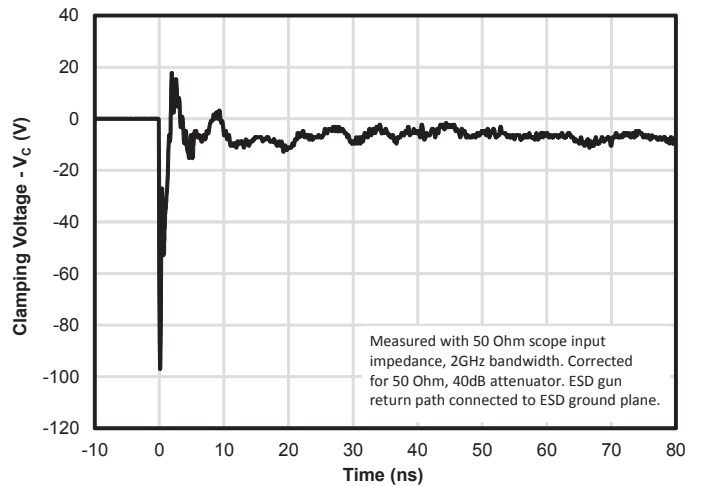
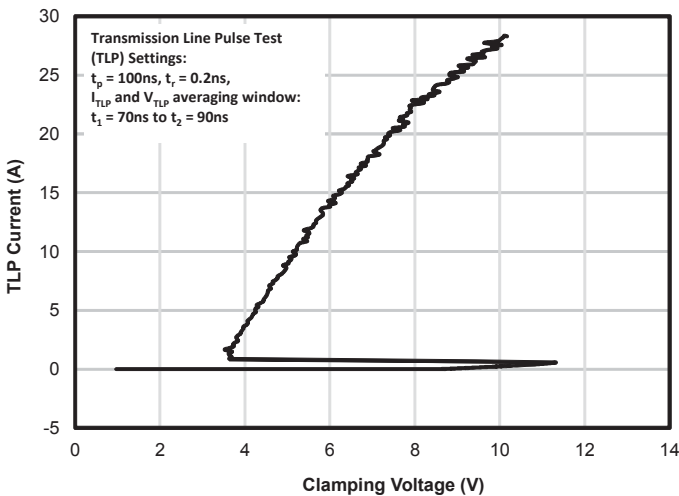
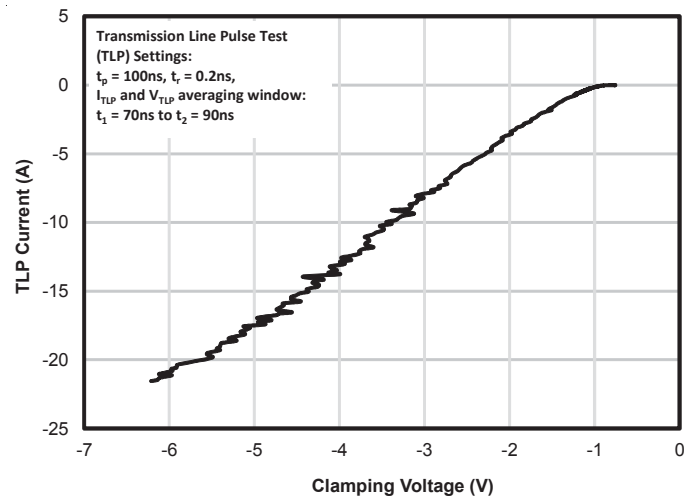
PROTECTION PRODUCTS
Typical Characteristics
Clamping Waveform, 8/20us Pulse

Junction Capacitance vs. Reverse Voltage

ESD Clamping (+8kV Contact per IEC 61000-4-2)

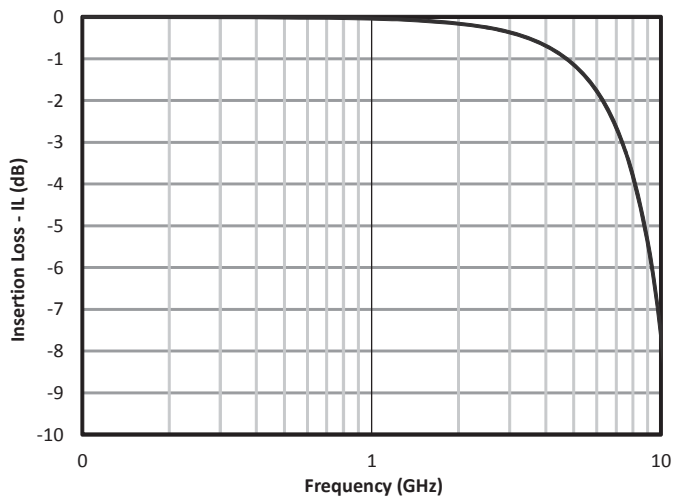
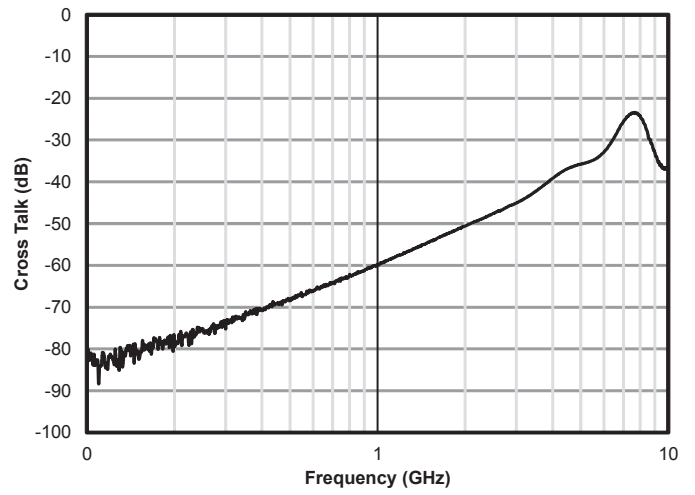
ESD Clamping (-8kV Contact per IEC 61000-4-2)

TLP Characteristic (Positive)

TLP Characteristic (Negative)

PROTECTION PRODUCTS

Typical Characteristics (Con't)

Typical Insertion Loss S21**Analog Crosstalk**

PROTECTION PRODUCTS
Applications Information
Device Operation

This device utilizes a multi-junction structure that is designed to switch to a low voltage state when triggered by ESD, EOS, or other transient events. During normal operation, the device will present a high-impedance to the circuit for voltage up to the working voltage (V_{RWM}) of the device. When the voltage across the device terminals exceeds the breakdown voltage (V_{BR}), avalanche breakdown occurs in the blocking junction causing the device to "snap-back" or switch to a low impedance on-state. This has the advantage of lowering the overall clamping voltage (V_C) as ESD peak pulse current (I_{PP}) flows through the device. Once the current decreases below the holding current (I_H), the device will return to a high-impedance off-state. Since this device is bidirectional, it will behave the same way for positive or negative polarity transient events.

Symbol	Parameter
V_{RWM}	Maximum Working Voltage
V_{BR}	Breakdown Voltage
V_C	Clamping Voltage
I_H	Holding Current
I_R	Reverse Leakage Current
I_{PP}	Peak Pulse Current

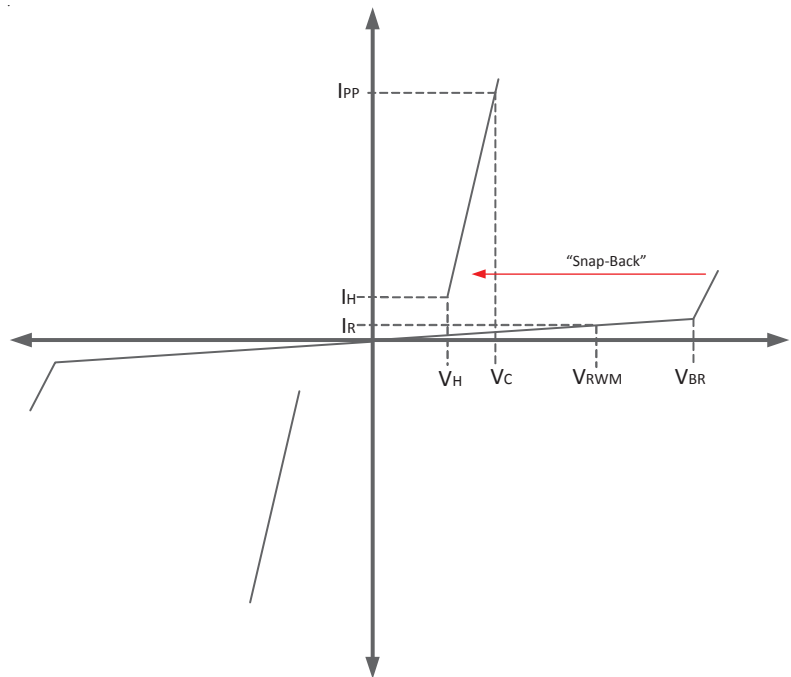

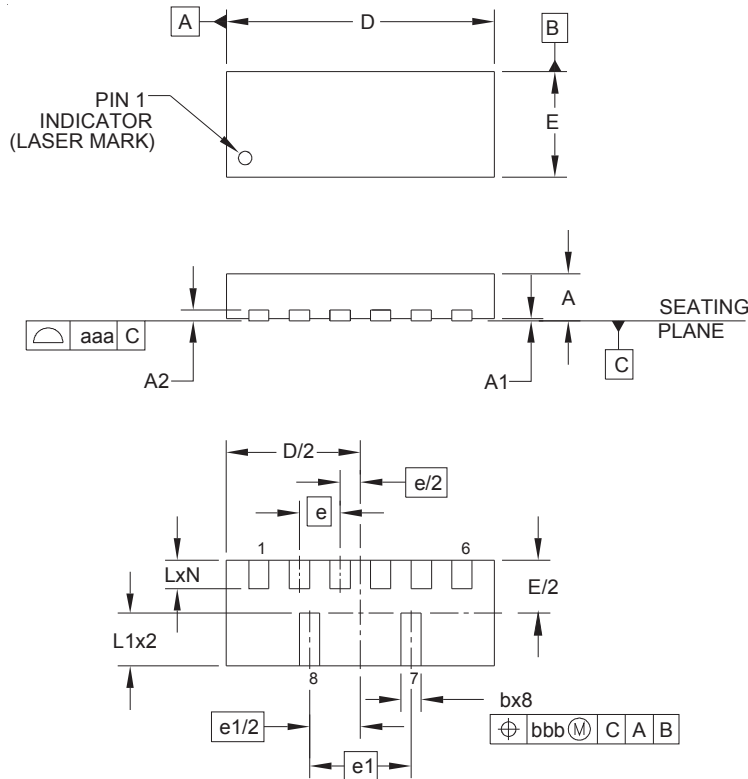
Characteristic Curve

PROTECTION PRODUCTS
Outline Drawing - SLP3313P6

DIMENSIONS			
DIM	MILLIMETERS		
	MIN	NOM	MAX
A	0.50	0.575	0.60
A1	0.00	0.02	0.05
A2		(0.13)	
b	0.20	0.25	0.30
D	3.25	3.30	3.35
E	1.25	1.30	1.35
e		0.50 BSC	
e1		1.25 BSC	
L	0.30	0.35	0.40
L1	0.60	0.65	0.70
N		6	
aaa		0.08	
bbb		0.10	

NOTES:

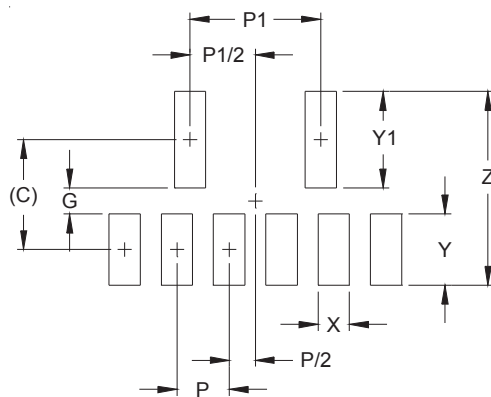
1. CONTROLLING DIMENSIONS ARE IN MILLIMETERS (ANGLES IN DEGREES).
2. COPLANARITY APPLIES TO THE EXPOSED PAD AS WELL AS THE TERMINALS.

Land Pattern - SLP3313P6

DIMENSIONS	
DIM	MILLIMETERS
C	(1.05)
G	0.25
P	0.50
P1	1.25
X	0.30
Y	0.68
Y1	0.92
Z	1.85

NOTES:

1. CONTROLLING DIMENSIONS ARE IN MILLIMETERS (ANGLES IN DEGREES).
2. THIS LAND PATTERN IS FOR REFERENCE PURPOSES ONLY. CONSULT YOUR MANUFACTURING GROUP TO ENSURE YOUR COMPANY'S MANUFACTURING GUIDELINES ARE MET.

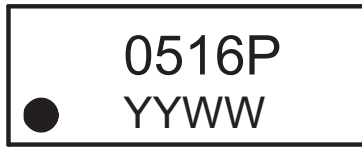
PROTECTION PRODUCTS
Marking Code

Ordering Information

Part Number	Qty per Reel	Reel Size
RClamp0516P.TCT	3,000	7 Inch

RailClamp and RClamp are trademarks of Semtech Corporation.

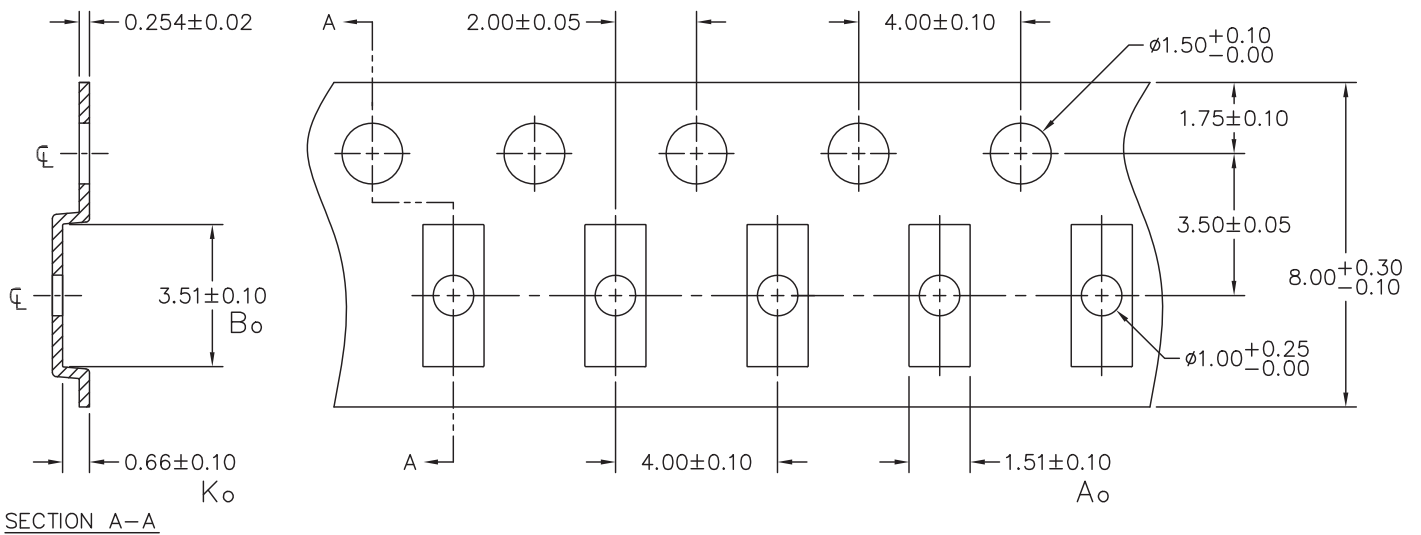
 YYWW = Date Code
 Dot indicates pin 1

Carrier Tape Specification

NOTES: 1.) ALL DIMENSIONS IN MILLIMETERS UNLESS OTHERWISE SPECIFIED.

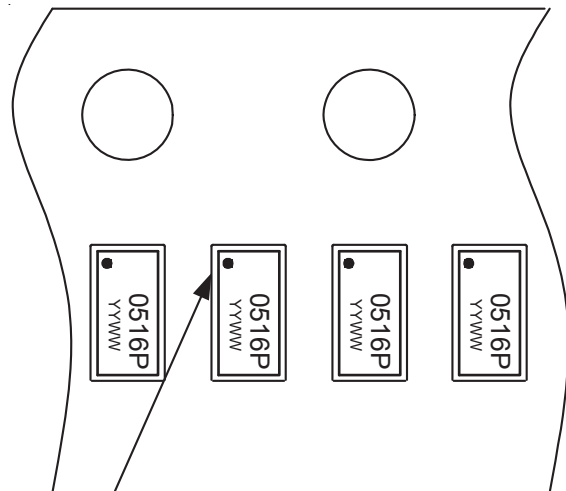

Pin 1 Location (Towards Sprocket Holes)

Device Orientation in Tape

Contact Information

Semtech Corporation
Protection Products Division
200 Flynn Road, Camarillo, CA 93012
Phone: (805)498-2111 FAX (805)498-3804