	E480232
---	----------------

Features

- For Surface Mount Applications in Order to Optimize Board Space
- Low Inductance
- Excellent Clamping Capability
- Fast Response Time: Typical Less Than 1ps From 0V to V_{BR} min
- Available in Both Unidirectional and Bidirectional Construction and Suffix "C" Designates Bidirectional Type
- Halogen Free. "Green" Device (Note 1)
- Moisture Sensitivity Level 1
- Epoxy Meets UL 94 V-0 Flammability Rating
- Lead Free Finish/RoHS Compliant (Note 2) ("P" Suffix Designates RoHS Compliant. See Ordering Information)

Mechanical Data

- Polarity: Color Band Denotes Positive end(cathode) Except Bi-directional Types
- Maximum Soldering Temperature: 260°C for 10 Seconds
- Terminals: Solderable Per MIL-STD-750, Method 2026

Maximum Ratings

- Operating Junction Temperature Range: -65°C to +150°C
- Storage Temperature Range: -65°C to +150°C
- Thermal Resistance : 20°C/W Junction to Lead
- Thermal Resistance : 25°C/W Junction to Case

Electrical Characteristics @ 25°C Unless Otherwise Specified

Peak Pulse Power Surge Current on 10/1000µs Waveform	I_{PP}	See the Table	Note 3
Peak Pulse Power Dissipation	P_{PP}	600W	Note 3
Maximum Instantaneous Forward Voltage @ at 1A for Unidirectional Only	V_F	1.5V	

NOTES:

1. Halogen free "Green" products are defined as those which contain <900ppm bromine, <900ppm chlorine (<1500ppm total Br + Cl) and <1000ppm antimony compounds.
2. High Temperature Solder Exemption Applied, see EU Directive Annex 7a.
3. Non-repetitive current pulse, per Fig.3 and derated above $T_A=25^\circ\text{C}$ per Fig.4

Pin Configuration:

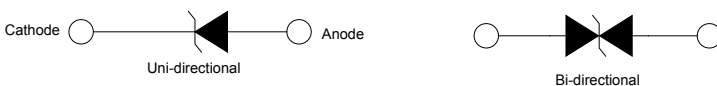

600 Watt TVS 5.0 to 440 Volts

SMB (DO-214AA) (LEAD FRAME)

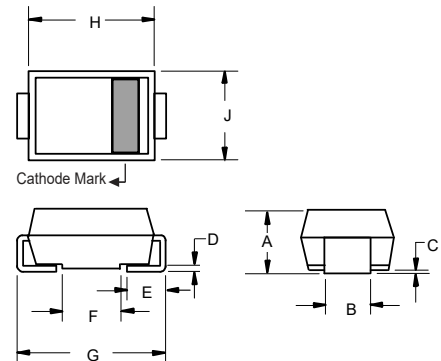

DIM	DIMENSIONS				NOTE
	INCHES		MM		
	MIN	MAX	MIN	MAX	
A	0.079	0.103	2.00	2.62	
B	0.075	0.087	1.91	2.21	
C	0.002	0.008	0.05	0.20	
D	0.006	0.012	0.15	0.31	
E	0.030	0.060	0.76	1.52	
F	0.065	0.091	1.65	2.32	
G	0.200	0.220	5.08	5.59	
H	0.160	0.191	4.06	4.85	
J	0.130	0.155	3.30	3.94	

Suggested Solder Pad Layout

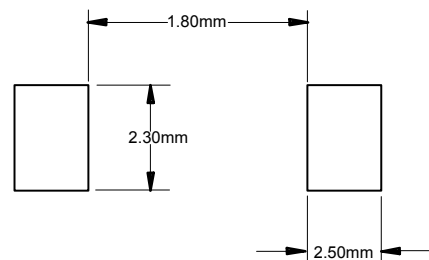

Electrical Characteristics @ 25°C Unless Otherwise Specified

MCC PART NUMBER	REVERSE STAND-OFF VOLTAGE V_{WM}	BREAKDOWN VOLTAGE $V_{(BR)} @ I_T$ (VOLTS)			MAXIMUM CLAMPING VOLTAGE @ I_{PP}	PEAK PULSE CURRENT I_{PP}	MAXIMUM REVERSE LEAKAGE @ V_{WM} I_D	MARKING CODE
	VOLTS	MIN	MAX	I_T (mA)	VOLTS	(AMPS)	(μ A)	
SMBJP6KE6.8A	5.80	6.45	7.14	10	10.5	58.1	1000	6V8A
SMBJP6KE7.5A	6.40	7.13	7.88	10	11.3	54.0	500	7V5A
SMBJP6KE8.2A	7.02	7.79	8.61	10	12.1	50.4	200	8V2A
SMBJP6KE9.1A	7.78	8.65	9.55	1	13.4	45.5	50	9V1A
SMBJP6KE10A	8.55	9.50	10.50	1	14.5	42.1	10	10A
SMBJP6KE11A	9.40	10.50	11.60	1	15.6	39.1	5	11A
SMBJP6KE12A	10.20	11.40	12.60	1	16.7	36.5	5	12A
SMBJP6KE13A	11.10	12.40	13.70	1	18.2	33.5	1	13A
SMBJP6KE15A	12.80	14.30	15.80	1	21.2	28.8	1	15A
SMBJP6KE16A	13.60	15.20	16.80	1	22.5	27.1	1	16A
SMBJP6KE18A	15.30	17.10	18.90	1	25.5	24.2	1	18A
SMBJP6KE20A	17.10	19.00	21.00	1	27.7	22.0	1	20A
SMBJP6KE22A	18.80	20.90	23.10	1	30.6	19.9	1	22A
SMBJP6KE24A	20.50	22.80	25.20	1	33.2	18.4	1	24A
SMBJP6KE27A	23.10	25.70	28.40	1	37.5	16.3	1	27A
SMBJP6KE30A	25.60	28.50	31.50	1	41.4	14.7	1	30A
SMBJP6KE33A	28.20	31.40	34.70	1	45.7	13.3	1	33A
SMBJP6KE36A	30.80	34.20	37.80	1	49.9	12.2	1	36A
SMBJP6KE39A	33.30	37.10	41.00	1	53.9	11.3	1	39A
SMBJP6KE43A	36.80	40.90	45.20	1	59.3	10.3	1	43A
SMBJP6KE47A	40.20	44.70	49.40	1	64.8	9.4	1	47A
SMBJP6KE51A	43.60	48.50	53.60	1	70.1	8.7	1	51A
SMBJP6KE56A	47.80	53.20	58.80	1	77.0	7.9	1	56A
SMBJP6KE62A	53.00	58.90	65.10	1	85.0	7.2	1	62A
SMBJP6KE68A	58.10	64.60	71.40	1	92.0	6.6	1	68A
SMBJP6KE75A	64.10	71.30	78.80	1	103.0	5.9	1	75A
SMBJP6KE82A	70.10	77.90	86.10	1	113.0	5.4	1	82A
SMBJP6KE91A	77.80	86.50	95.50	1	125.0	4.9	1	91A
SMBJP6KE100A	85.50	95.00	105.00	1	137.0	4.5	1	100A
SMBJP6KE110A	94.00	105.00	116.00	1	152.0	4.0	1	110A
SMBJP6KE120A	102.00	114.00	126.00	1	165.0	3.7	1	120A
SMBJP6KE130A	111.00	124.00	137.00	1	179.0	3.4	1	130A
SMBJP6KE150A	128.00	143.00	158.00	1	207.0	2.9	1	150A
SMBJP6KE160A	136.00	152.00	168.00	1	219.0	2.8	1	160A
SMBJP6KE170A	145.00	162.00	179.00	1	234.0	2.6	1	170A
SMBJP6KE180A	154.00	171.00	189.00	1	246.0	2.5	1	180A
SMBJP6KE200A	171.00	190.00	210.00	1	274.0	2.2	1	200A
SMBJP6KE220A	185.00	209.00	231.00	1	328.0	1.9	1	220A
SMBJP6KE250A	214.00	237.00	263.00	1	344.0	1.9	1	250A
SMBJP6KE300A	256.00	285.00	315.00	1	414.0	1.5	1	300A
SMBJP6KE350A	300.00	332.00	368.00	1	482.0	1.3	1	350A
SMBJP6KE400A	342.00	380.00	420.00	1	548.0	1.1	1	400A
SMBJP6KE440A	376.00	418.00	462.00	1	602.0	1.0	1	440A
SMBJP6KE480A	408.00	456.00	504.00	1	658.0	0.9	1	480A
SMBJP6KE510A	434.00	485.00	535.00	1	698.0	0.9	1	510A
SMBJP6KE530A	477.00	503.50	556.50	1	725.0	0.8	1	530A
SMBJP6KE540A	459.00	513.00	567.00	1	740.0	0.8	1	540A
SMBJP6KE550A	495.00	522.50	577.50	1	760.0	0.8	1	550A

For bi-directional type having V_{WM} of 10 volts and less, the I_R limit is double.
The available parts are "A" type only, the parts without A (V_{BR} is $\pm 10\%$) is not available.

Electrical Characteristics @ 25°C Unless Otherwise Specified

MCC PART NUMBER	REVERSE STAND-OFF VOLTAGE V_{WM}	BREAKDOWN VOLTAGE $V_{(BR)} @ I_T$ (VOLTS)			MAXIMUM CLAMPING VOLTAGE@ I_{PP}	PEAK PULSE CURRENT I_{PP}	MAXIMUM REVERSE LEAKAGE @ V_{WM} I_D	MARKING CODE
	VOLTS	MIN	MAX	I_T (mA)	VOLTS	(AMPS)	(μ A)	
SMBJP6KE6.8CA	5.80	6.45	7.14	10	10.5	58.1	1000	6V8C
SMBJP6KE7.5CA	6.40	7.13	7.88	10	11.3	54.0	500	7V5C
SMBJP6KE8.2CA	7.02	7.79	8.61	10	12.1	50.4	200	8V2C
SMBJP6KE9.1CA	7.78	8.65	9.55	1	13.4	45.5	50	9V1C
SMBJP6KE10CA	8.55	9.50	10.50	1	14.5	42.1	10	10C
SMBJP6KE11CA	9.40	10.50	11.60	1	15.6	39.1	5	11C
SMBJP6KE12CA	10.20	11.40	12.60	1	16.7	36.5	5	12C
SMBJP6KE13CA	11.10	12.40	13.70	1	18.2	33.5	5	13C
SMBJP6KE15CA	12.80	14.30	15.80	1	21.2	28.8	5	15C
SMBJP6KE16CA	13.60	15.20	16.80	1	22.5	27.1	5	16C
SMBJP6KE18CA	15.30	17.10	18.90	1	25.5	24.2	5	18C
SMBJP6KE20CA	17.10	19.00	21.00	1	27.7	22.0	5	20C
SMBJP6KE22CA	18.80	20.90	23.10	1	30.6	19.9	5	22C
SMBJP6KE24CA	20.50	22.80	25.20	1	33.2	18.4	5	24C
SMBJP6KE27CA	23.10	25.70	28.40	1	37.5	16.3	5	27C
SMBJP6KE30CA	25.60	28.50	31.50	1	41.4	14.7	5	30C
SMBJP6KE33CA	28.20	31.40	34.70	1	45.7	13.3	5	33C
SMBJP6KE36CA	30.80	34.20	37.80	1	49.9	12.2	5	36C
SMBJP6KE39CA	33.30	37.10	41.00	1	53.9	11.3	5	39C
SMBJP6KE43CA	36.80	40.90	45.20	1	59.3	10.3	5	43C
SMBJP6KE47CA	40.20	44.70	49.40	1	64.8	9.4	5	47C
SMBJP6KE51CA	43.60	48.50	53.60	1	70.1	8.7	5	51C
SMBJP6KE56CA	47.80	53.20	58.80	1	77.0	7.9	5	56C
SMBJP6KE62CA	53.00	58.90	65.10	1	85.0	7.2	5	62C
SMBJP6KE68CA	58.10	64.60	71.40	1	92.0	6.6	5	68C
SMBJP6KE75CA	64.10	71.30	78.80	1	103.0	5.9	5	75C
SMBJP6KE82CA	70.10	77.90	86.10	1	113.0	5.4	5	82C
SMBJP6KE91CA	77.80	86.50	95.50	1	125.0	4.9	5	91C
SMBJP6KE100CA	85.50	95.00	105.00	1	137.0	4.5	5	100C
SMBJP6KE110CA	94.00	105.00	116.00	1	152.0	4.0	5	110C
SMBJP6KE120CA	102.00	114.00	126.00	1	165.0	3.7	5	120C
SMBJP6KE130CA	111.00	124.00	137.00	1	179.0	3.4	5	130C
SMBJP6KE150CA	128.00	143.00	158.00	1	207.0	2.9	5	150C
SMBJP6KE160CA	136.00	152.00	168.00	1	219.0	2.8	5	160C
SMBJP6KE170CA	145.00	162.00	179.00	1	234.0	2.6	5	170C
SMBJP6KE180CA	154.00	171.00	189.00	1	246.0	2.5	5	180C
SMBJP6KE200CA	171.00	190.00	210.00	1	274.0	2.2	5	200C
SMBJP6KE220CA	185.00	209.00	231.00	1	328.0	1.9	5	220C
SMBJP6KE250CA	214.00	237.00	263.00	1	344.0	1.9	5	250C
SMBJP6KE300CA	256.00	285.00	315.00	1	414.0	1.5	5	300C
SMBJP6KE350CA	300.00	332.00	368.00	1	482.0	1.3	5	350C
SMBJP6KE400CA	342.00	380.00	420.00	1	548.0	1.1	5	400C
SMBJP6KE440CA	376.00	418.00	462.00	1	602.0	1.0	5	440C
SMBJP6KE480CA	408.00	456.00	504.00	1	658.0	0.9	5	480C
SMBJP6KE510CA	434.00	485.00	535.00	1	698.0	0.9	5	510C
SMBJP6KE530CA	477.00	503.50	556.50	1	725.0	0.8	5	530C
SMBJP6KE540CA	459.00	513.00	567.00	1	740.0	0.8	5	540C
SMBJP6KE550CA	495.00	522.50	577.50	1	760.0	0.8	5	550C

For bi-directional type having V_{WM} of 10 volts and less, the I_R limit is double.
The available parts are "A" type only, the parts without A (V_{BR} is $\pm 10\%$) is not available.

Curve Characteristics

Fig. 1 - Peak Pulse Power Rating Curve

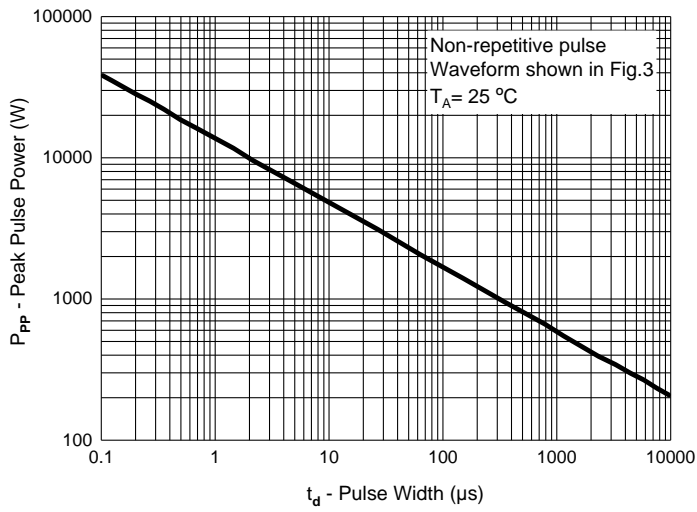

Fig. 2 - Typical Junction Capacitance

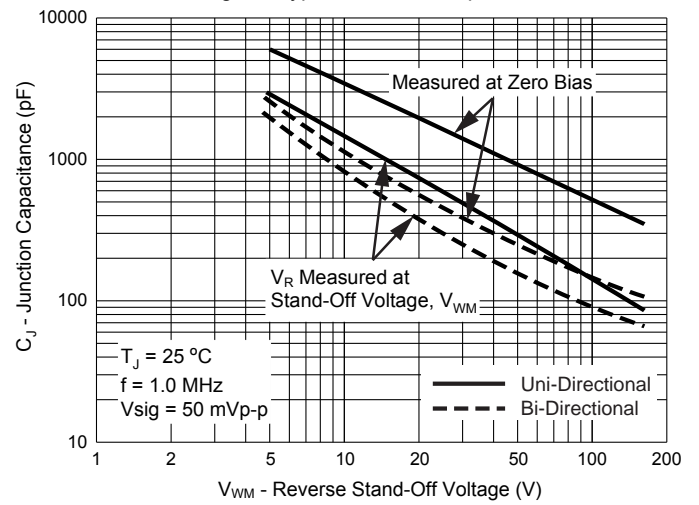

Fig. 3 - Pulse Waveform

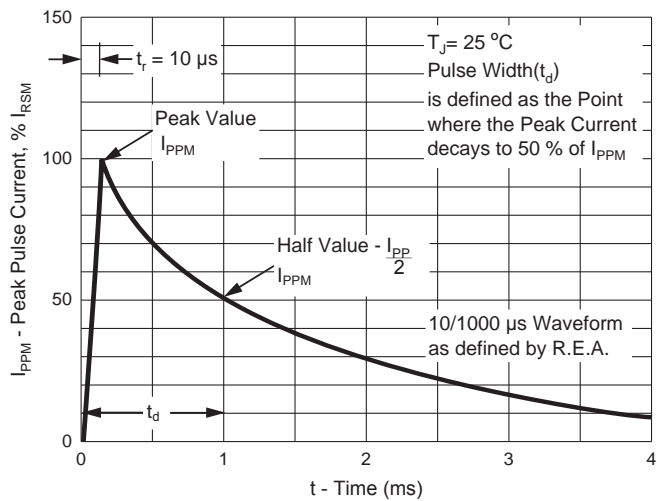
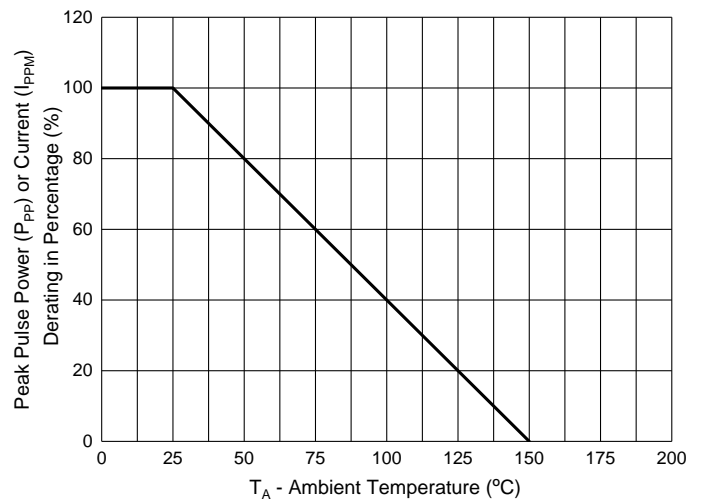

Fig. 4 - Pulse Derating Curve



Ordering Information

Device	Packing
Part Number-TP	Tape&Reel:3Kpcs/Reel

IMPORTANT NOTICE

Micro Commercial Components Corp. reserves the right to make changes without further notice to any product herein to make corrections, modifications, enhancements, improvements, or other changes. **Micro Commercial Components Corp.** does not assume any liability arising out of the application or use of any product described herein; neither does it convey any license under its patent rights, nor the rights of others. The user of products in such applications shall assume all risks of such use and will agree to hold **Micro Commercial Components Corp.** and all the companies whose products are represented on our website, harmless against all damages. **Micro Commercial Components Corp.** products are sold subject to the general terms and conditions of commercial sale, as published at <https://www.mccsemi.com/Home/TermsAndConditions>.

LIFE SUPPORT

MCC's products are not authorized for use as critical components in life support devices or systems without the express written approval of Micro Commercial Components Corporation.

CUSTOMER AWARENESS

Counterfeiting of semiconductor parts is a growing problem in the industry. Micro Commercial Components (MCC) is taking strong measures to protect ourselves and our customers from the proliferation of counterfeit parts. MCC strongly encourages customers to purchase MCC parts either directly from MCC or from Authorized MCC Distributors who are listed by country on our web page cited below. Products customers buy either from MCC directly or from Authorized MCC Distributors are genuine parts, have full traceability, meet MCC's quality standards for handling and storage. **MCC will not provide any warranty coverage or other assistance for parts bought from Unauthorized Sources.** MCC is committed to combat this global problem and encourage our customers to do their part in stopping this practice by buying direct or from authorized distributors.