

CONTINUOUS VOLTAGE SMD CRYSTAL OSCILLATOR

ASADV

Request Samples



Check Inventory



ESD Sensitive

2.0 x 1.6 x 0.80mm

RoHS/RoHS II Compliant

MSL Level = N/A

Features

- Continuous Vdd operation from 1.6 V ~ 3.6 V
- Optimized for low current consumption
- Output Enable/Start & Disable/Stop function
- Output waveform CMOS/HCMOS/LVCMOS compatible
- Hermetically seam-sealed ceramic package

Applications

- Portable & wearable electronics
- Internet of Things (IoT)
- Consumer electronics
- Industrial control & automation
- Mobile communication

Electrical Specifications

Parameters	Min.	Typ.	Max.	Units	Notes
Frequency Range	1.25		100	MHz	
Operating Temperature Range	-40		+85	°C	See options
Storage Temperature Range	-55		+125	°C	
Overall Frequency Stability [Note 1]	-25		+25	ppm	See options
Supply Voltage (Vdd)	1.6		3.6	V	
Tri-state function	"1" (VIH≥0.7*Vdd) or Open: Oscillation; "0" (VIL<0.3*Vdd): No Oscillation/Hi Z			V	
Output Load			15	pF	CMOS
Output Voltage	VOH	0.9*Vdd		V	
	VOL		0.1*Vdd		
Aging 1 year @25°C± 3°C	-3.0		+3.0	ppm	
Aging 5 years @25°C± 3°C	-5.0		+5.0	ppm	
Symmetry @ ½ Vdd	45	50	55	%	
Start-up Time			10.0	ms	
Rise and Fall Time (Tr/Tf) @10%Vdd-90%Vdd, 15pF load	Vdd = 1.8V to 3.6V		8.0	ns	1.25MHz ≤ F ≤ 19.999MHz
			6.0		20MHz ≤ F ≤ 39.999MHz
			5.0		40MHz ≤ F ≤ 69.999MHz
			5.0		70MHz ≤ F ≤ 100MHz
	Vdd = 1.6V		10.0		1.25MHz ≤ F ≤ 19.999MHz
			8.0		20MHz ≤ F ≤ 39.999MHz
			6.0		40MHz ≤ F ≤ 69.999MHz
			6.0		70MHz ≤ F ≤ 100MHz
RMS Period Jitter @25°C± 3°C	Vdd = 3.0V to 3.6V		5.0	ps	
	Vdd = 1.6V to 2.5V		7.0		
RMS Phase Jitter @25°C± 3°C (10 - 39MHz: 12kHz to 5MHz) (>39MHz: 12kHz to 20MHz)			< 1.0	ps	
Disable Current			10.0	µA	

*Note 1: Overall frequency stability includes initial frequency tolerance @25°C± 3°C and stability over the operating temperature range.



5101 Hidden Creek Ln Spicewood TX 78669
 Phone: 512-371-6159 | Fax: 512-351-8858
 For terms and conditions of sales, please visit:
www.abracon.com

REVISED: 03-24-20

ABRACON IS
 ISO9001-2015
 CERTIFIED

CONTINUOUS VOLTAGE SMD CRYSTAL OSCILLATOR

ASADV

Request Samples



Check Inventory



ESD Sensitive

2.0 x 1.6 x 0.80mm
RoHS/RoHS II Compliant
MSL Level = N/A

Electrical Specifications *continued*

Parameters	Min.	Typ.	Max.	Units	Notes
Supply Current (I _{dd}) into 15pF Load @25°C± 3°C @ V _{dd} =3.3V			2.0	mA	1.25MHz ≤ F ≤ 5.999MHz
			2.0		6MHz ≤ F ≤ 9.999MHz
			3.0		10MHz ≤ F ≤ 19.999MHz
			4.0		20MHz ≤ F ≤ 29.999MHz
			5.0		30MHz ≤ F ≤ 39.999MHz
			5.0		40MHz ≤ F ≤ 45.999MHz
			5.0		46MHz ≤ F ≤ 48.999MHz
			6.0		49MHz ≤ F ≤ 50.999MHz
			8.0		51MHz ≤ F ≤ 54.999MHz
			8.0		55MHz ≤ F ≤ 60.999MHz
			12.5		61MHz ≤ F ≤ 75.999MHz
			14.5		76MHz ≤ F ≤ 80.999MHz
			14.5		81MHz ≤ F ≤ 100MHz
	Supply Current (I _{dd}) into 15pF Load @25°C± 3°C @ V _{dd} =2.5V				1.3
			1.3	6MHz ≤ F ≤ 9.999MHz	
			2.0	10MHz ≤ F ≤ 19.999MHz	
			3.0	20MHz ≤ F ≤ 29.999MHz	
			3.5	30MHz ≤ F ≤ 39.999MHz	
			4.5	40MHz ≤ F ≤ 45.999MHz	
			4.5	46MHz ≤ F ≤ 48.999MHz	
			5.0	49MHz ≤ F ≤ 50.999MHz	
			6.5	51MHz ≤ F ≤ 54.999MHz	
			7.0	55MHz ≤ F ≤ 60.999MHz	
			10.0	61MHz ≤ F ≤ 75.999MHz	
			11.5	76MHz ≤ F ≤ 80.999MHz	
			11.5	81MHz ≤ F ≤ 100MHz	
Supply Current (I _{dd}) into 15pF Load @25°C± 3°C @ V _{dd} =1.8V				1.0	mA
			1.0	6MHz ≤ F ≤ 9.999MHz	
			1.6	10MHz ≤ F ≤ 19.999MHz	
			2.2	20MHz ≤ F ≤ 29.999MHz	
			2.5	30MHz ≤ F ≤ 39.999MHz	
			3.0	40MHz ≤ F ≤ 45.999MHz	
			3.5	46MHz ≤ F ≤ 48.999MHz	
			3.5	49MHz ≤ F ≤ 50.999MHz	
			3.5	51MHz ≤ F ≤ 54.999MHz	
			4.0	55MHz ≤ F ≤ 60.999MHz	
			9.0	61MHz ≤ F ≤ 75.999MHz	
			9.0	76MHz ≤ F ≤ 80.999MHz	
			10.0	81MHz ≤ F ≤ 100MHz	

CONTINUOUS VOLTAGE SMD CRYSTAL OSCILLATOR

ASADV

Request Samples



Check Inventory



ESD Sensitive

2.0 x 1.6 x 0.80mm
RoHS/RoHS II Compliant
MSL Level = N/A

Typical Current Consumption (I_{dd}) vs. Supply Voltage (V_{dd}) Characteristics @ 25°C ± 3°C [Load = 15pF]

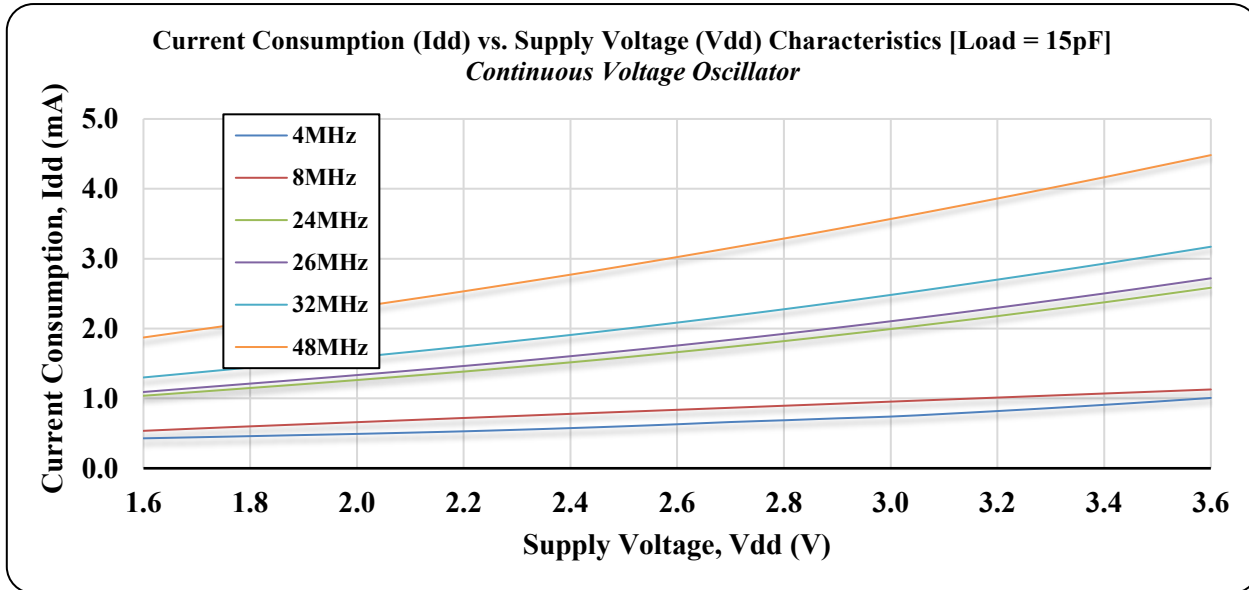

Typical Frequency vs. Supply Voltage (V_{dd}) Characteristics @ 25°C ± 3°C

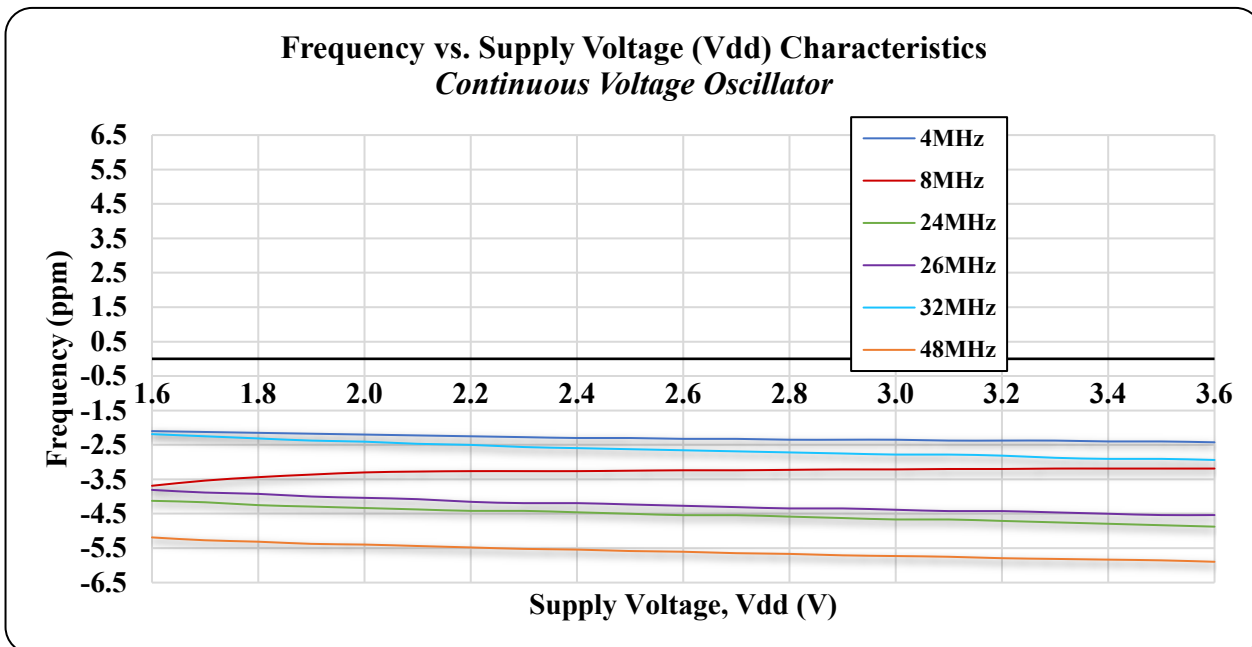

CONTINUOUS VOLTAGE SMD CRYSTAL OSCILLATOR

ASADV

Request Samples



Check Inventory



ESD Sensitive

2.0 x 1.6 x 0.80mm
RoHS/RoHS II Compliant
MSL Level = N/A

Typical Frequency vs. Temperature Characteristics

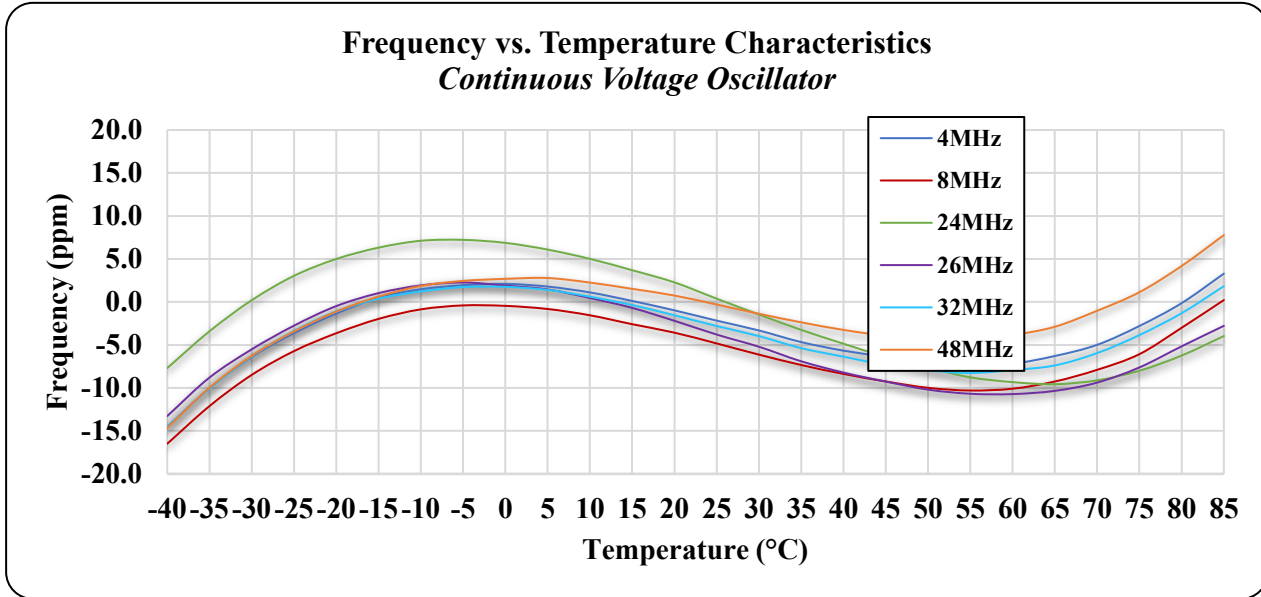

Part Identification

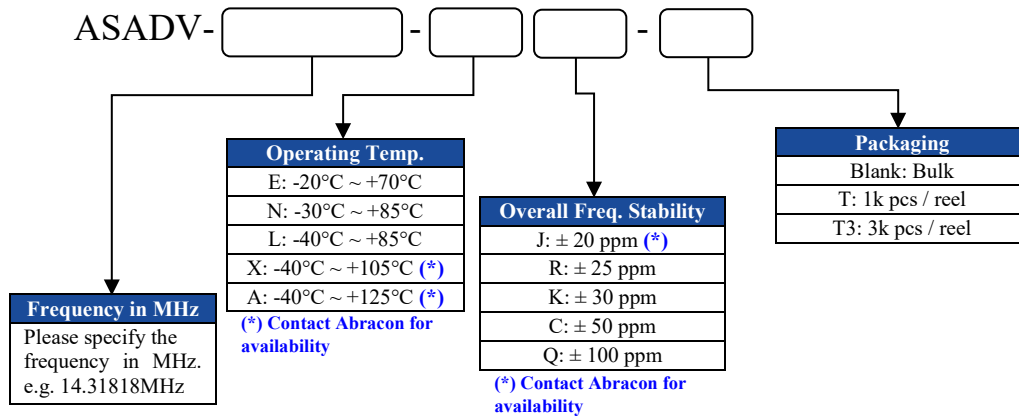

CONTINUOUS VOLTAGE SMD CRYSTAL OSCILLATOR

ASADV

Request Samples 

Check Inventory 



2.0 x 1.6 x 0.80mm
RoHS/RoHS II Compliant
MSL Level = N/A

Mechanical Dimensions

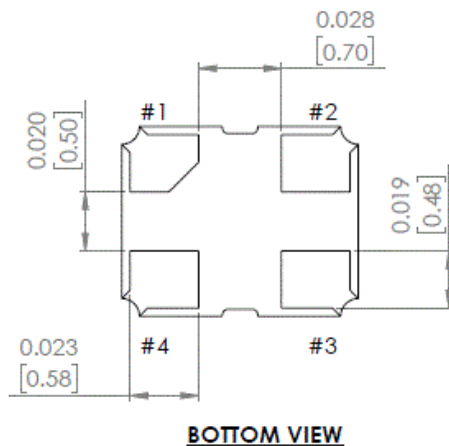
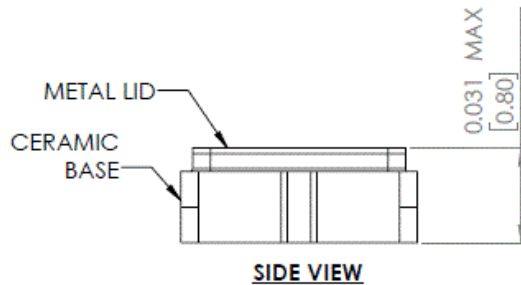
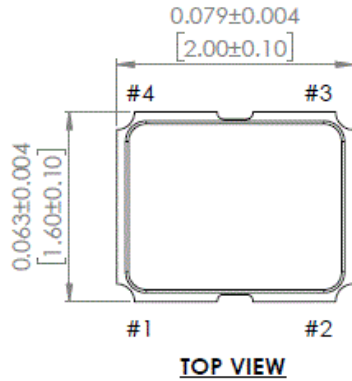

Recommended Land Pattern

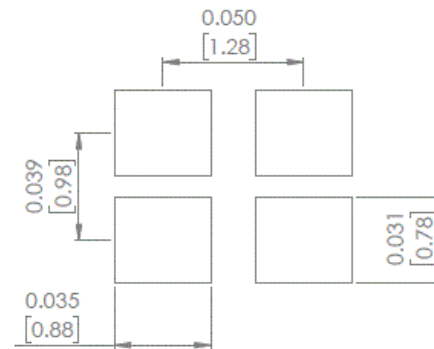

Pin #	Function
1	Tri-State
2	GND
3	Output
4	Vdd

Note: Recommended to use approximately 0.01µF bypass capacitor between PIN 2 and PIN 4

Dimensions: inches (mm)



5101 Hidden Creek Ln Spicewood TX 78669
Phone: 512-371-6159 | Fax: 512-351-8858
For terms and conditions of sales, please visit:
www.abracon.com

REVISED: 03-24-20

ABRACON IS
ISO9001-2015
CERTIFIED

CONTINUOUS VOLTAGE SMD CRYSTAL OSCILLATOR

ASADV

Request Samples 

Check Inventory 



2.0 x 1.6 x 0.80mm
RoHS/RoHS II Compliant
MSL Level = N/A

Reflow Profile

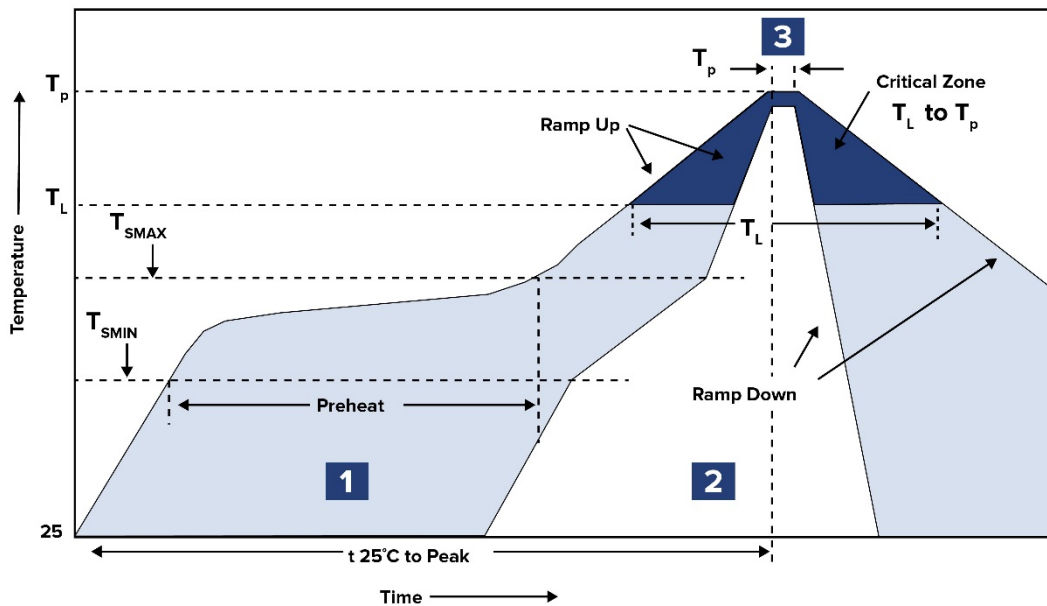

Zone	Description	Temperature	Time
1	Preheat	$T_{SMIN} \sim T_{SMAX}$ 150°C ~ 200°C	60 ~ 120 sec.
2	Reflow	T_L 217°C	60 ~ 150 sec.
3	Peak heat	T_P 250°C ~ 260°C	30 sec. MAX

CONTINUOUS VOLTAGE SMD CRYSTAL OSCILLATOR

ASADV

Request Samples



Check Inventory



ESD Sensitive

2.0 x 1.6 x 0.80mm
RoHS/RoHS II Compliant
MSL Level = N/A

Packaging

T: 1,000pcs/reel

T3: 3,000pcs/reel

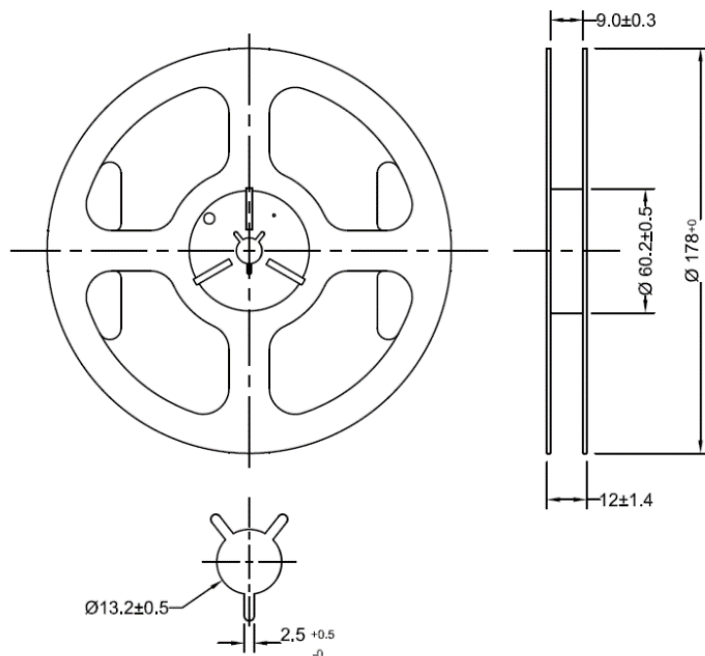
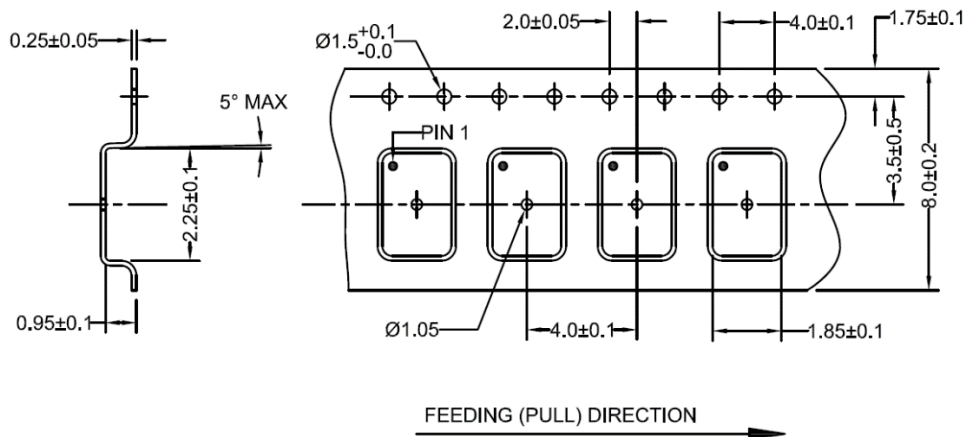

Dimensions: inches (mm)

ATTENTION: Abracon LLC's products are COTS – Commercial-Off-The-Shelf products; suitable for Commercial, Industrial and, where designated, Automotive Applications. Abracon's products are not specifically designed for Military, Aviation, Aerospace, Life-dependent Medical applications or any application requiring high reliability where component failure could result in loss of life and/or property. For applications requiring high reliability and/or presenting an extreme operating environment, written consent and authorization from Abracon LLC is required. Please contact Abracon LLC for more information.



5101 Hidden Creek Ln Spicewood TX 78669
Phone: 512-371-6159 | Fax: 512-351-8858
For terms and conditions of sales, please visit:
www.abracon.com

REVISED: 03-24-20

ABRACON IS
ISO9001-2015
CERTIFIED