

Features

- 420W peak pulse power (8/20 μ s)
- Protects two bi-directional lines
- Ultra low leakage: nA level
- Operating voltage: 24V
- Low clamping voltage
- Complies with following standards:
 - IEC 61000-4-2 (ESD) immunity test
Air discharge: \pm 30kV
Contact discharge: \pm 30kV
 - IEC61000-4-4 (EFT) 40A (5/50ns)
 - IEC61000-4-5 (Lightning) 9A (8/20 μ s)
- RoHS Compliant

Applications

- Cellular Handsets and Accessories
- Notebooks and Handhelds
- Portable Instrumentation
- Set Top Box
- Industrial Controls
- Server and Desktop PC

Mechanical Characteristics

- Package: SOT-23
- Lead Finish: Lead Free
- UL Flammability Classification Rating 94V-0
- Quantity Per Reel:3,000pcs
- Reel Size:7inch
- Device Marking:24M

Absolute Maximum Ratings (Tamb=25°C unless otherwise specified)

Parameter	Symbol	Value	Unit
Peak Pulse Power (8/20 μ s)	Ppk	420	W
Peak Pulse Current (8/20 μ s)	IPP	9	A
ESD per IEC 61000-4-2 (Air)	VESD	\pm 30	kV
ESD per IEC 61000-4-2 (Contact)		\pm 30	
Operating Temperature Range	TJ	-55 to +125	°C
Storage Temperature Range	Tstg	-55 to +150	°C

Dimensions SOT-23



Pin Configuration

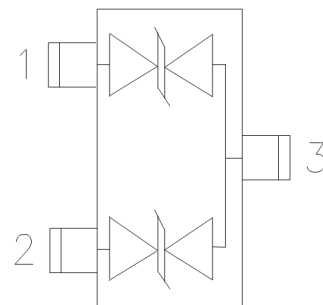

Electrical Characteristics($T_A=25^{\circ}\text{C}$ unless otherwise specified)

Parameter	Symbol	Test Condition	Min	Typ	Max	Unit
Reverse Working Voltage	V_{RWM}				24	V
Breakdown Voltage	V_{BR}	$I_T = 1\text{mA}$	26	28.5	30.5	V
Reverse Leakage Current	I_R	$V_{RWM} = 24\text{V}$			0.5	μA
Clamping Voltage	V_C	$I_{PP} = 1\text{A}$ (8 x 20 μs pulse)		35	40	V
Clamping Voltage	V_C	$I_{PP} = 9\text{A}$ (8 x 20 μs pulse)		45	58	V
Junction Capacitance	C_J	$V_R = 0\text{V}$, $f = 1\text{MHz}$		30	50	pF

Characteristic Curves

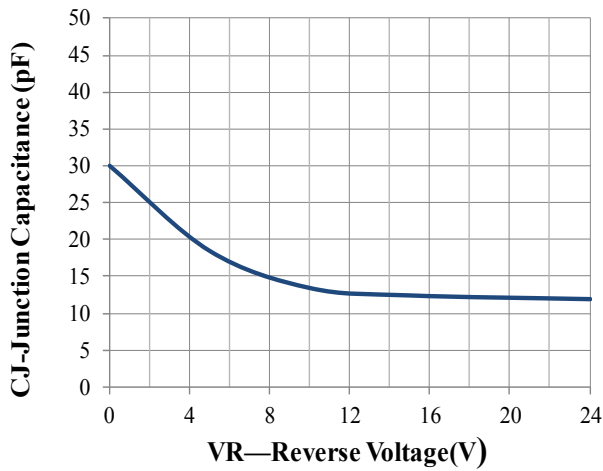

Junction Capacitance vs. Reverse Voltage

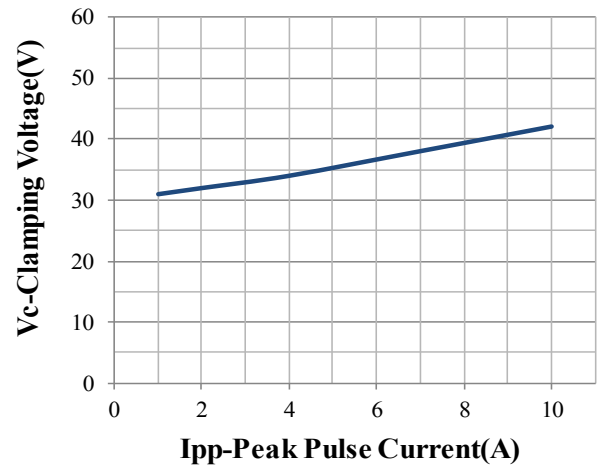

Clamping Voltage vs. Peak Pulse Current

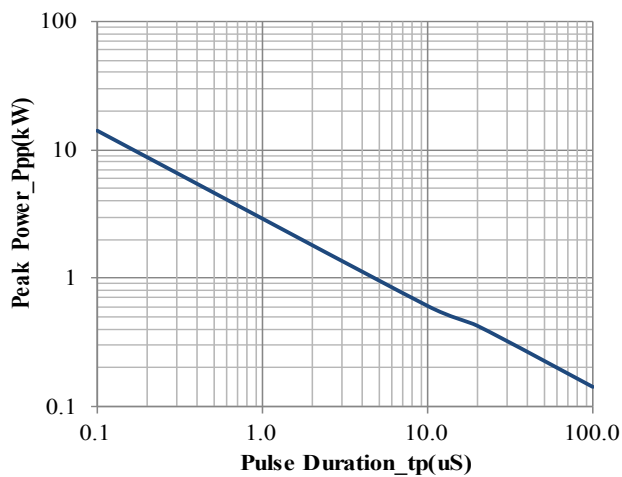

Peak Pulse Power vs. Pulse Time

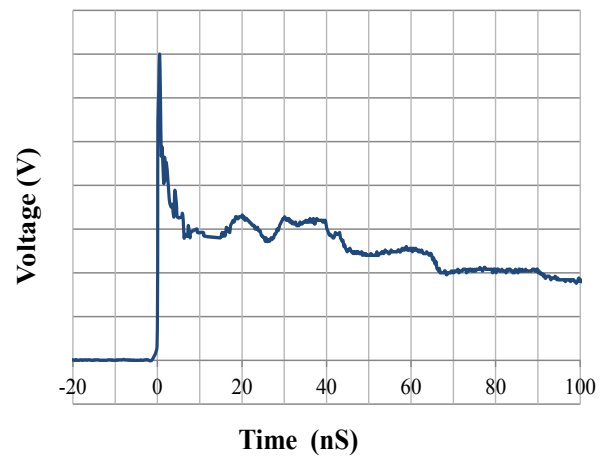

IEC61000-4-2 Pulse Waveform

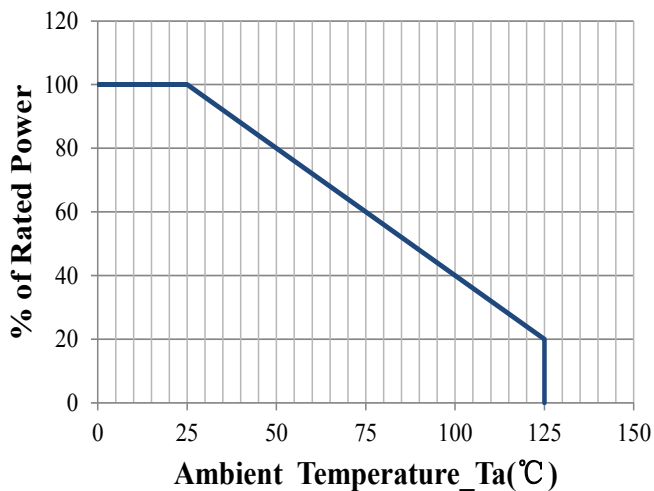

Power Derating Curve

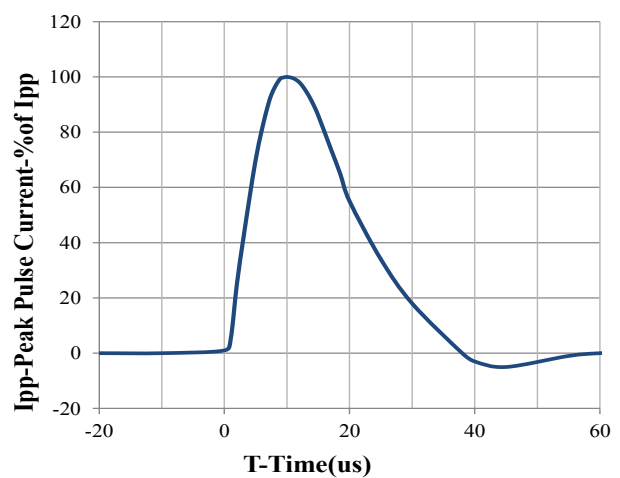

8 X 20us Pulse Waveform

SOT-23 Package Outline & Dimensions

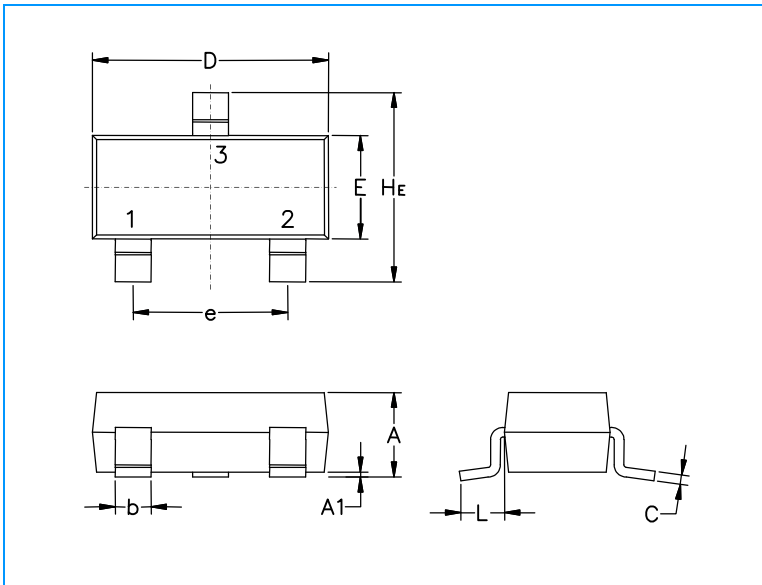

Symbol	Millimeters			Inches		
	Min.	Nom.	Max.	Min.	Nom.	Max.
A	0.89	1.00	1.11	0.035	0.040	0.044
A1	0.01	0.06	0.10	0.001	0.002	0.004
b	0.37	0.44	0.50	0.15	0.18	0.020
c	0.09	0.13	0.18	0.003	0.005	0.007
D	2.80	2.90	3.04	0.110	0.114	0.120
E	1.20	1.30	1.40	0.047	0.051	0.055
e	1.78	1.90	2.04	0.070	0.075	0.081
L	0.35	0.54	0.69	0.014	0.021	0.029
HE	2.10	2.40	2.64	0.083	0.094	0.104

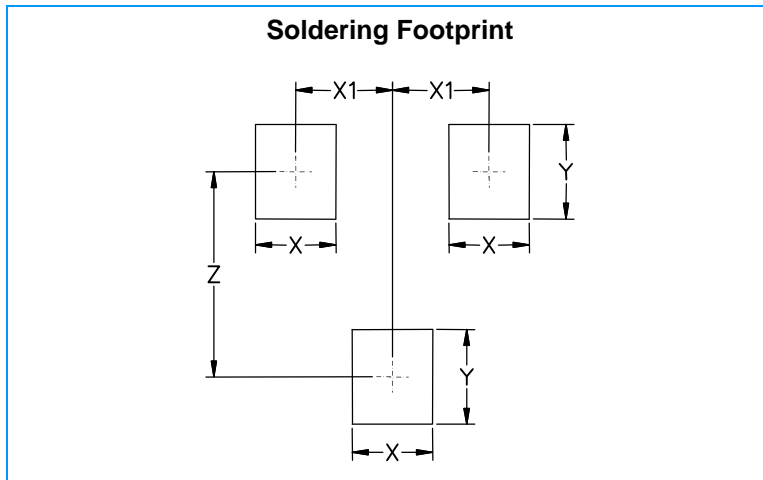

Symbol	Millimeters	Inches
X	0.80	0.031
X1	0.95	0.037
Y	0.90	0.035
Z	2.00	0.079