

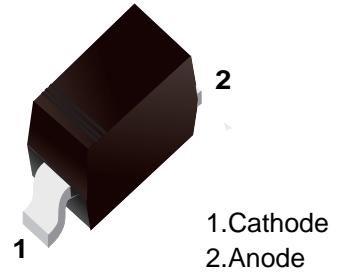

**■ Features**

- Fast Switching Speed
- For General Purpose Switching Applications.
- High Conductance
- Surface Mount Package Ideally Suited for Automatic Insertion

**■ Simplified outline(SOD-323)**

 Top View 
**■ Marking**

Marking	T7
---------	----

**■ Absolute Maximum Ratings Ta = 25°C**

Parameter	Symbol	Rating	Unit
Reverse Voltage	$V_{RM}$	300	V
Peak Repetitive Peak Reverse Voltage	$V_{RRM}$	300	
Working Peak Reverse Voltage	$V_{RWM}$		
DC Blocking Voltage	$V_R$		
RMS Reverse Voltage	$V_{R(RMS)}$	71	mA
Average Rectified Output Current	$I_O$	300	
Forward Continuous Current	$I_{FM}$	400	A
Peak Forward Surge Current @ $t=1\mu s$	$I_{FSM}$	2	
@ $t=1s$		1	
Power Dissipation	$P_d$	500	mW
Thermal Resistance Junction to Ambient	$R_{\theta JA}$	250	°C/W
Junction Temperature	$T_J$	150	°C
Storage Temperature range	$T_{stg}$	-55 to 150	

**■ Electrical Characteristics Ta = 25°C**

Parameter	Symbol	Test Conditions	Min	Typ	Max	Unit
Reverse breakdown voltage	$V_R$	$I_R=100\mu A$	100			V
Forward voltage	$V_{F1}$	$I_F=1mA$			0.715	
	$V_{F2}$	$I_F=10mA$			0.855	
	$V_{F3}$	$I_F=50mA$			1	
	$V_{F4}$	$I_F=150mA$			1.25	
Reverse voltage leakage current	$I_{R1}$	$V_R=75V$			1	uA
	$I_{R2}$	$V_R=20V$			25	nA
Junction capacitance	$C_j$	$V_R=0V, f=1MHz$			2	pF
Reverse recovery time	$t_{rr}$	$I_F=I_R=10mA, I_{rr}=0.1I_R, R_L=100\Omega$			4	ns

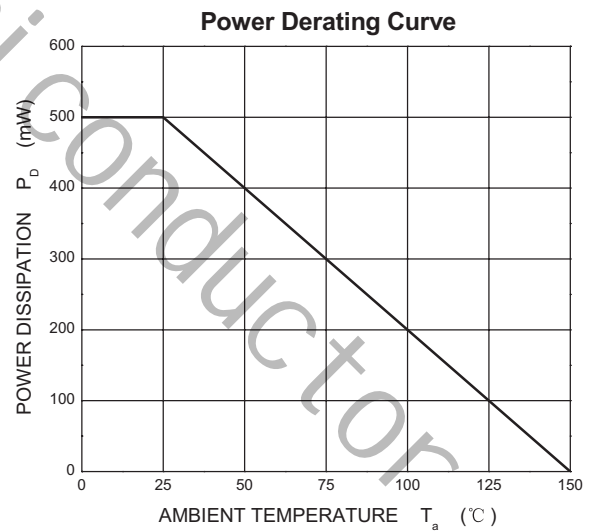
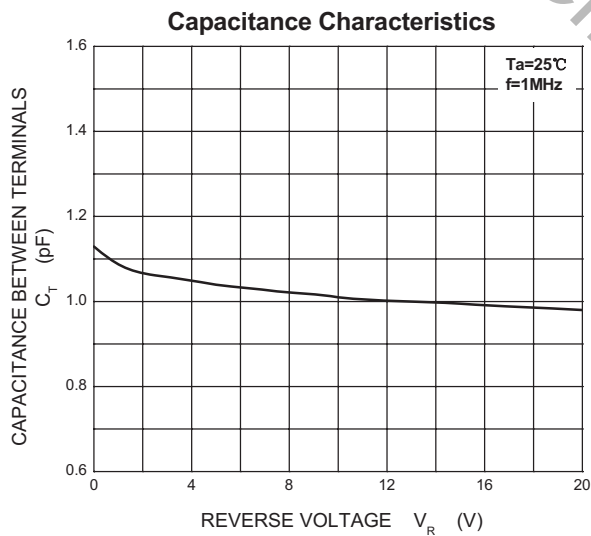
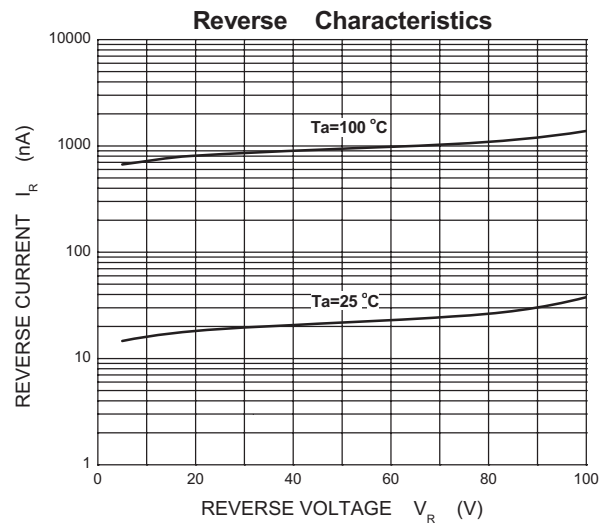
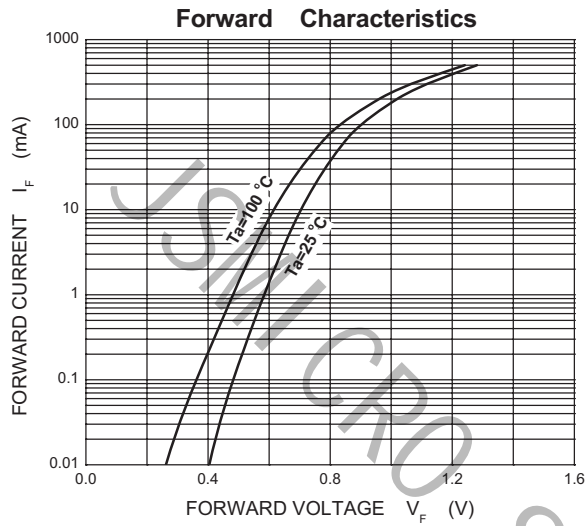
**Typical Characteristics**

■ SOD-323

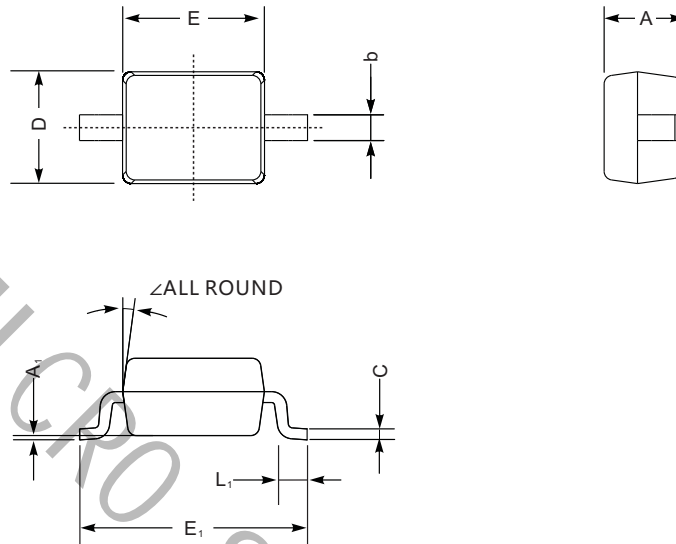

SOD-323 mechanical data

UNIT		A	C	D	E	E <sub>1</sub>	b	L <sub>1</sub>	A <sub>1</sub>	∠
mm	max	1.1	0.15	1.4	1.8	2.75	0.4	0.45	0.2	9°
	min	0.8	0.08	1.2	1.4	2.55	0.25	0.2	—	
mil	max	43	5.9	55	70	108	16	16	8	
	min	32	3.1	47	63	100	9.8	7.9	—	

■ The recommended mounting pad size

