

## 规格承认书

Specification for approval

客户名称:

( Customer Name )

产品名称:

( Product Name )

科尼盛料号:

( KNSCHA number )

型号规格:

( Specifications )

客户料号:

( Customer part number )

Y1安规电容

Y1 Safety Capacitance

KY1102M400VAC70Y10093

Y1 102M/400VAC P=10mm Y5V

Y1 102M/400VAC P=10mm Y5V

制 造 (Manufacture)			客 户 (Customer)		
Approval			Approval		
拟 制 (Fiction)	审 核 (Chief)	核 准 (Approval)	检 验 (Inspect)	审 核 (Chief)	核 准 (Approval)
	 刘淑芬	刘军军			
		徐贵南			

东莞市科尼盛电子有限公司

DONG GUAN KNSCHA ELECTRONICS CO.,LTD.

No. 4, Liaodong Road, 1st Industrial Zone, Pengwu Village,

Dongkeng Town, Dongguan, Guangdong, China

TEL:0769-83698067 81035570 FAX: 0769-83861559

Email : [sales@knscha.com](mailto:sales@knscha.com) Website: <http://www.knscha.com>



**交流陶瓷电容器规格书**  
**Specifications for a.c. ceramic capacitors**

**JT 系列 Y1 电容器**  
**JT Series Y1 Capacitors**

Edition A0  
October 9, 2015  
BULANC DANRY

**RoHS**  
**REACH**



目录 Directory

封面 Cover.....	1
修订履历 Revision history.....	2
目录 Directory.....	3
1. 范围 Scope.....	4
2. 目的 Object.....	4
3. 引用标准 Normative references.....	4-5
4. 术语和定义 Terms and definitions.....	5-6
5. 编码说明 How to order.....	6
6. 认证标准和档案号码 Approval standard and file number.....	6
7. 电容器结构图 The constituent parts of capacitor.....	7
8. 外型图及尺寸代码 Figure and code of dimension.....	7
9. 容量和尺寸表 Capacitance and dimension.....	8
10. 温度特性曲线 Temperature characteristic of capacitor.....	9
11. 环境管理物质含量控制要求 Requirements for concentration limits for certain hazardous substances.....	9
12. 性能与试验 Performance and test.....	10-14
13. 标志图案 Marking design.....	15
14. 包装 Packing.....	15-16
15. 贮存 Storage.....	17
16. 敬告和警告 Cautions and warnings.....	17
17. 交流陶瓷电容器常识 General knowledge for AC ceramic capacitors.....	18

## 1. 范围 Scope

Y1 交流陶瓷电容器适用于工作电压不超过 1000VAC，频率不超过 100Hz 的电子电气设备中。Y1 a.c ceramic capacitors are used in electrical and electronic equipment and connected an a.c main with nominal voltage not exceeding 1000va.c, and with a nominal frequency not exceeding 100Hz.

## 2. 目的 Object

规定 Y1 交流陶瓷电容器优先额定值和特性，试验和测量方法以及性能要求。The principal object of this standard is to prescribe preferred ratings and characteristics and to select the appropriate tests and measuring methods and to give general performance requirements for Y1 a.c. ceramic capacitors.

## 3. 引用标准 Normative references

- IEC 60384-1: 2008-07 Edition 4.0 (GB/T 2693-2001)  
电子设备用固定电容器 第 1 部分 总规范  
Fixed capacitors for use in electronic equipment-Part 1: Generic specification
- IEC 60384-14: 2013-06 Edition 4.0 (GB/T 14472-1998)  
电子设备用固定电容器 第 14 部分 分规范 抑制电源电磁干扰用固定电容器  
Fixed capacitors for use in electronic equipment-Part 14: Sectional specification  
Fixed capacitors for electromagnetic interference suppression and connection to the supply mains
- GB/T 5169.5-1997 (IDT IEC 60695-2-2:1991) 电工电子产品着火危险试验  
第 2 部分: 试验方法 第 2 篇: 针焰试验  
Fire hazard testing for electronic products Part 2: Test methods  
Section 2: Needle-flame test
- GB/T 2828.1-2003 (IDT ISO 2859-1:1999) 计数抽样检验程序  
第 1 部分 按接受限(AQL)检索的逐批检验抽样计划  
Sampling procedures for inspection by attributes-  
Part 1: Sampling schemes indexed by acceptance quality limit(AQL)for lot-blot inspection
- GB/T 2471-1995 (IDT IEC 63:1963): 电阻器和电容器优先数系  
Preferred number series for resistors and capacitors
- GB/T 2691-1994 (IDT IEC 62:1992): 电阻器和电容器的标志代码  
Marking codes for resistors and capacitors
- GB/T 26572-2011: 电子信息产品中有毒有害物质的限量要求  
Requirements for concentration limits for certain hazardous substances in electronic information products
- SJ/T 11364-2006: 电子信息产品污染控制标识要求  
Marking for control of pollution caused by electronic information products
- GB/T 26125-2011: 电子信息产品中有毒有害物质的检测方法  
Testing methods for hazardous substances in electronic information products
- 2011/65/EU (RoHS2.0): 电子电气设备中限制使用某些有害物质指令  
The Restriction of the use of certain Hazardous Substances in electrical and electronic equipment
- 2012/19/EU (WEEE2.0): 废旧电子电气设备指令

Waste Electrical and Electronic Equipment

2013/2/EU: 欧盟关于包装和包装废弃物指令

Europe parliament and council directive on packaging and packaging waste

No1907/2006(REACH): 化学品注册、评估、许可和限制(高关注物质)

Registration, Evaluation, Authorization and Restriction of Chemicals(SVHC)

## 4. 术语和定义 Terms and definitions

### 4.1 交流电容器 a.c. capacitor

主要设计用于交流电压的一种电容器

注: 交流电容器可以用在与电容器额定电压交流有效值相同电压的直流电源。

Capacitor designed essentially for application with a power-frequency alternating voltage.

NOTE: a.c. capacitor may be used on d.c. supplies having the same voltage as the a.c. r.m.s. rated voltage of the capacitor.

### 4.2 Y 类电容器 capacitor of class Y

一种适用于在电容器失效时会导致电击危险的场合的电容器。Capacitor of a type suitable for use in situations where failure of the capacitor could lead to danger of electric shock.

### 4.3 额定电压 rated voltage

电容器在额定频率下的交流有效值, 或直流工作电压。该电压可以在下限类别温度和上限类别温度之间的任一温度下连续施加到电容器的引出端上。Either the r.m.s. operating voltage of rated frequency or the d.c. operating voltage, which may be applied continuously to the terminations of a capacitor at any temperature between the lower and the upper category temperatures.

### 4.4 损耗角正切 tangent of loss angle( $\tan\delta$ )

在规定频率的正弦电压下, 电容器的损耗功率除以电容器的无功功率。The power loss of the capacitor divided by the reactive power of the capacitor at a sinusoidal voltage at a specified frequency.

### 4.5 上限类别温度 upper category temperature

电容器在连续工作时的最高表面温度。Maximum surface temperature for which the capacitor has been designed to operate continuously.

### 4.6 下限类别温度 lower category temperature

电容器在连续工作时的最低表面温度。Minimum surface temperature for which the capacitor has been designed to operate continuously.

### 4.7 气候类别 climatic category

电容器的气候类别用字母(标准 DIN40040: 例 FME)或数字(标准 IEC68-1: 例 55/85/21)来表示。第一个字母或第一段两位数字代表下限类别温度; 第二个字母或第二段两位数字代表上限类别温度, 第三个字母或第三段两位数字代表稳态湿热的天数。The climatic category which the capacitor belong to is expressed in numbers (IEC 60068-1e.g.:25/125/21).The first number represents the lower category temperature(e.g.: $-25^{\circ}\text{C}$ ); the second number represents the upper category temperature (e.g.: $+125^{\circ}\text{C}$ ) and the third number represents the number of days relevant to the damp heat test (e.g.:21days)



#### 4. 电容量随温度变化 temperature characteristic of capacitor



电容器在不超出类别温度范围的给定温度范围内所出现的电容量最大可逆变化。此变化表示为相对于 20℃ 时电容量的百分比。The maximum reversible variation of capacitance produced over a given temperature range within the category temperature range, normally expressed as a percentage of the capacitance related to a reference temperature of 20℃.

#### 5. 编码说明 How to order

JT	F	222	M	2G	F0	200	A	068	E
Series	Dielectric	Capacitance	Tolerance	Rate voltage	Leads spacing	Leads length	Lead Type	Dielectric diameter	E:
JT: Y1	B: Y5P F: Y5V E: Y5U	222:2200PF 101:100PF 103:10000PF	K: ±10% M: ±20%	2G: 400V 2E: 250V 2F: 300V	F0: 10mm F7: 7.5mm	200: 20mm 028: 2.8mm	A: Straight C: outside k	068: 6.8mm 115: 11.5mm	Blue epoxy resin

容量代码用三位数表示，前两位表示有效数字，后一位表示有效数字后面零的个数。Codes for capacitance shall be find expression in three numbers. The first two digits are significant, and the third digit is number of zero.

#### 6. 认证标准和档案号码 Approval standard and file numbe

Testing and Certification Institute	STANDARD NO.	CLASS TYPE W.V C.C P.F.C	FILE NO.	MARK	Issued/ Revised day
VDE	DIN EN 60384-14 (VDE 0565-1-1): 2014-04 EN60384-14:2013-08 IEC 60384-14(ed.4)	JT X1 440VAC Y1 250/300/400VAC 25/125/21B	40043090		2015-10-06
UL	UL 60384-14 2014-07 CSA E60384-14 2014-10 CSA E60384-1 2014-10	JT X1 440VAC Y1 250/300/400VAC 25/125/21B	E477850		2015-09-22
CQC	IEC 60384-14:2005	JT X1 440VAC Y1 400VAC 25/125/21B	CQC1500 1132573		2015-10-15

### 7. 电容器结构图 The constituent parts of capacitor

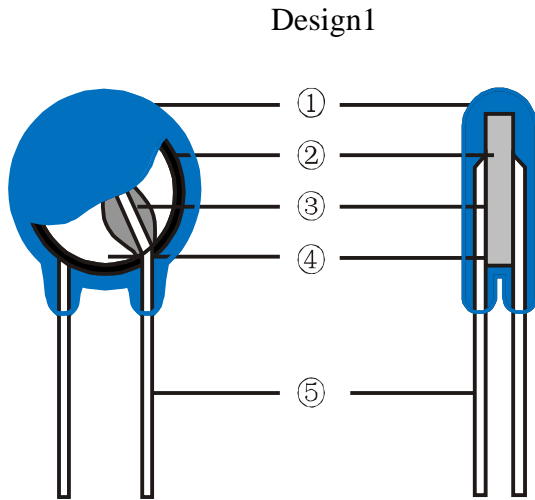

Table 2

NO.	部位名称 constituent	材料 material
①	包封层 Coating	环氧树脂 Epoxy resin
②	陶瓷介质 Ceramic medium	陶瓷 Ceramic
③	焊接点 Solder	焊锡 Soldering tin
④	电极 Electrode	银浆 Silver oxide
⑤	引脚 Lead Frame	CP线 CP wire

### 8. 外型图及尺寸代码 Figure and code of dimension

Design2

TYPE A: 直脚 Straight

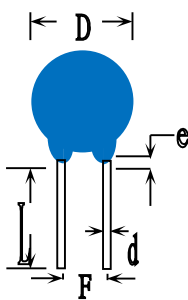

TYPE C: 外K脚 Outside Kink

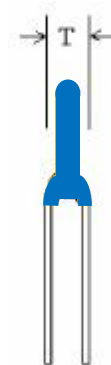
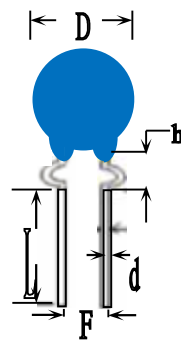

TYPE D: 前后弯 Front and back curve

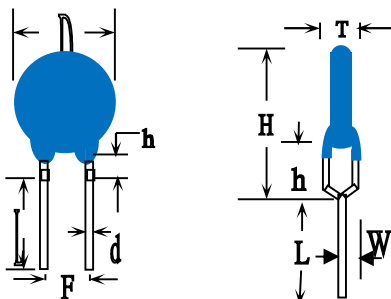

TYPE E: 平膊 Flat shoulder

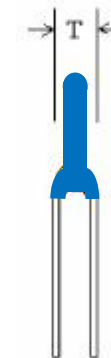
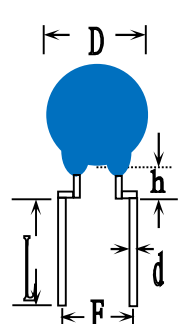



**9. 容量和尺寸表 Capacitance and dimension**

JT series – CLASS Y1

Table 3

Part Number	Temp Char	Cap Value (pF)	CAP TOL	DIMENSION(mm)			
				D ±1.0	F ±0.8	T ±0.8	d ±0.05
JTB100K□□□□□□	Y5P (B) ±10%	10	K ±10%	6.0	10	3.5	0.55
JTB150K□□□□□□		15		6.0			
JTB220K□□□□□□		22		6.0			
JTB330K□□□□□□		33		6.0			
JTB470K□□□□□□		47		7.0			
JTB560K□□□□□□		56		7.0			
JTB680K□□□□□□		68		7.5			
JTB820K□□□□□□		82		8.0			
JTB101K□□□□□□	Y5P (B) ±10%	100	K ±10%	6.5	10	4.5	0.55
JTB151K□□□□□□		150		6.5			
JTB221K□□□□□□		220		6.5			
JTB331K□□□□□□		330		7.5			
JTB471K□□□□□□		470		7.5			
JTB561K□□□□□□		560		8.2			
JTB681K□□□□□□		680		9.0			
JTB821K□□□□□□		820		10.0			
JTB102K□□□□□□		1000		10.5			
JTE471M□□□□□□	Y5U (E) +22% -56%	470	M ±20%	6.5	10	4.5	0.55
JTE561M□□□□□□		560		7.3			
JTE681M□□□□□□		680		7.3			
JTE821M□□□□□□		820		7.3			
JTE102M□□□□□□		1000		7.5			
JTE152M□□□□□□		1500		8.5			
JTE222M□□□□□□		2200		10.0			
JTE332M□□□□□□		3300		12.0			
JTE392M□□□□□□		3900		13.0			
JTE472M□□□□□□		4700		14.5			
JTF102M□□□□□□	Y5V (F) +22% -82%	1000	M ±20%	6.5	10	4.5	0.55
JTF152M□□□□□□		1500		7.5			
JTF222M□□□□□□		2200		8.2			
JTF332M□□□□□□		3300		10.0			
JTF392M□□□□□□		3900		11.0			
JTF472M□□□□□□		4700		11.5			

### 10. 温度特性曲线 Temperature characteristic of capacitor

Design3

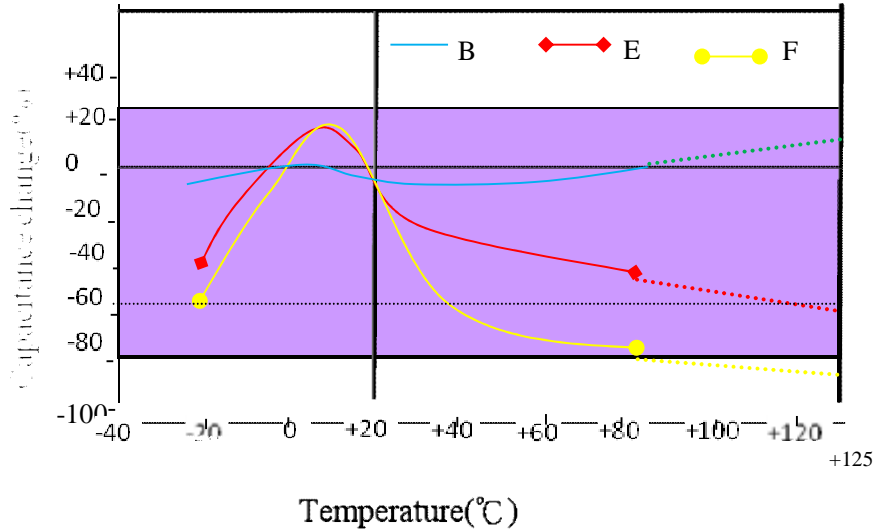

### 11. 环境管理物质含量控制要求

#### Requirements for concentration limits for certain hazardous substances

物质名称 Substances	限制含量 Concentration (unit: ppm)
镉及镉化合物 Cadmium and cadmium compounds	<100
铅及铅化合物 Lead and lead compounds	<1000
汞及汞化合物 Mercury and mercury compounds	<1000
六价铬及六价铬化合物 Hexavalent chromium compounds	<1000
多溴联苯 PBBS Polubrominated biphenyls	<1000
多溴联苯醚 PBDES Polubrominated diphenylethers	<1000
镉+铅+汞+六价铬 (包装材料) Cd+Pb+ Hg + Cr <sup>+6</sup> (packing materials)	<100
氯 Cl	<900
溴 Br	<900
氯+溴 Cl+Br	<1500
REACH 高关注物质 SVHC	<1000

Table 4



## 12. 性能与试验 Performance and test

Table 5

NO	试验项目 Test item		性能要求 Performance requirements	试验条件 Conditions of test												
1	4.1 外观检查 Visual examination		无可见损伤, 印字清晰 引脚无发黑氧化且无异物 No visible damage Legible marking Lead frame is not oxidation and its surface is without sundries.	目视或用放大镜观察 unaided eye or magnifier												
2	4.1 尺寸 Dimensions		满足 Table3 accorder Table3	用游标卡尺测量 vernier caliper												
3	4.1 印字 Marking		符合标识图案 design4 accorder design4	目视或用放大镜观察 unaided eye or magnifier												
4	4.2.1 耐电压 Voltage proof	端子间 Between lead wire	无永久性击穿或飞弧 No permanent break-down or flashover during the test period	试验电压 Test voltage: 4000VAC 电压频率 Frequency: 50/60Hz 施加时间 Duration: 60 seconds 漏电流 Leakage current: 5mA max												
		端子与封装间 Body insulation	无永久性击穿或飞弧 No permanent break-down or flashover during the test period	试验电压 Test voltage: 4000VAC 电压频率 Frequency: 50/60Hz 施加时间 Duration: 60 seconds 漏电流 Leakage current: 5mA max												
5	4.2.2 电容量 Capacitance		在允许公差范围内 Within specified tolerance K: ±10% M: ±20%	环境温度 Temperature: 25±3℃ 环境湿度 Humidity: 55±30%RH 测量电压 Voltage: 1.0±0.2V 测量频率 Frequency: 1±0.2KHz (C<100pF: 1±0.2MHz)												
6	4.2.3 损耗角正切 tanδ Dissipation factor		在规格范围内 Within specified tolerance Y5P: ≤0.025 Y5U: ≤0.025 Y5V: ≤0.025	环境温度 Temperature: 25±3℃ 环境湿度 Humidity: 55±30%RH 测量电压 Voltage: 1.0±0.2V 测量频率 Frequency: 1±0.2KHz (C<100pF: 1±0.2MHz)												
7	4.2.4 电容量随温度变化 Capacitance-temperature characteristic		符合类别温度范围内的电容量变化率Δ: Y5P: ±10% Y5U: +22%~-56% Y5V: +22%~-82%	将电容置于下列各温度点并测量电容量(温度误差±2℃)Temperature tolerance:±2℃ <table border="1"> <tr> <td>step</td> <td>1</td> <td>2</td> <td>3</td> <td>4</td> <td>5</td> </tr> <tr> <td>Tem (°C)</td> <td>+20</td> <td>-25</td> <td>+20</td> <td>+85</td> <td>+20</td> </tr> </table> $\Delta=(C_x-C_0)/C_0$ C <sub>x</sub> capacitance for step2,4 C <sub>0</sub> capacitance for step 3	step	1	2	3	4	5	Tem (°C)	+20	-25	+20	+85	+20
step	1	2	3	4	5											
Tem (°C)	+20	-25	+20	+85	+20											

8	4.2.5 绝缘电阻 Insulation resistance	端子间 Between lead wire	10GΩ MIN	试验电压 Test voltage: 100VDC 电压频率 Frequency: 50/60Hz 试验时间 Duration: 60 seconds 漏电流 Leakage current: 5mA max
		端子与 本体间 Body insulation	10GΩ MIN	试验电压 Test voltage: 100VDC 电压频率 Frequency: 50/60Hz 试验时间 Duration: 60 seconds 漏电流 Leakage current: 5mA max
9	4.3 引出端 强度 Robustness of terminations	抗拉 强度 tensile	引线无断裂, 电容器无可见损伤。 Lead wire shall not cut off. Capacitor shall not be broken. No visible damage.	将电容器固定, 在引线引出端紧固 10N 的砝码并持续 10 秒 Fixed capacitor's body, Lead wire fastening a weight of 10N and keep for 10s
		折弯 强度 bending	引线无断裂, 电容器无可见损伤。 Lead wire shall not cut off. Capacitor shall not be broken. No visible damage.	将电容引线沿每个方向连续两次 90 度弯曲。Two consecutive bends shall be applied in each direction
10	4.4 耐焊接热 Resistance to soldering heat	外观 visual examination	无可见损伤 no visible damage	焊槽温度: 260±10℃ 浸入深度: 离安装面 2 <sup>0</sup> -.5mm, 采用厚 度 1.5±0.5mm 的绝热屏蔽板。 浸入时间: 10±1 秒 试验后电容恢复时间: 24±2h Solder temperature: 260±10℃ Immersion time: 10±1seconds The depth of immersion: 2 <sup>+0</sup> -.5mm from the seating plane Using a thermal insulating screen of 1.5±0.5mm thickens After test the capacitors shall be recovered for 24±2hours at 25±3℃
		耐电压 voltage proof	满足 4.2.1 accorder 4.2.1	
		电容量 capacitance	$\Delta=(C_X-C_0)/C_0$ $\Delta: \pm 10\%$	
		损耗角 tanδ dissipation factor	Y5P: ≤0.025 Y5U: ≤0.025 Y5V: ≤0.025	
		绝缘电阻 Insulation resistance	满足 4.2.5 accorder 4.2.5	
11	4.5 可焊性 Solderability	焊锡良好, 焊料 流动性良好, 焊 料在 3S 内润湿 引线 Good tinning as evidenced by free flowing of the solder with wetting of the terminations or solder shall flow within 3s.	焊槽温度: 260±10℃ 浸入深度: 离安装面 2 <sup>+0</sup> -.5mm, 采用厚度 1.5±0.5mm 的绝 热屏蔽板。 浸入时间: 2±0.5 秒 试验后电容恢复时间: 24±2h Bath temperature: 260±10℃ Immersion time: 2±0.5seconds Depth of immersion (from the seating plane or component body): Capacitors below 2 <sup>0</sup> -.5mm, using a thermal insulating screen of 1.5±0.5mm thickness.	

12	4.6 温度快速变化 Rapid change of temperature	电容器无可见损伤 No visible damage		试验温度： 上限 125℃，下限-25℃ 循环次数：5 次 极限温度保持时间：30 分钟 Test temperature: Upper category temperature +125±3℃ Lower category temperature -25±3℃ number of cycles :5 Duration of exposure at the temperature limits: 30minutes
13	4.7 振动 Vibration	电容器无可见损伤 No visible damage		振动频率 10→55→10Hz 一分钟内完成全振幅，振幅 1.5mm,持续时间为 6 小时 (X,Y,Z 三个方向各 2 小时) Frequency ranges:10→55→10Hz swing:0.75mm, The total duration shall be 6 hours. duration of exposure at X,Y,Z: 2hours
14	4.12 稳态湿热 Damp heat (steady state)	外观检查 visual examination	无可见损伤 No visible damage	试验温度：40±2℃ 相对湿度：93±3%RH 持续时间：21 天 施加电压：400VAC(U <sub>R</sub> )一半电容施加电压，一半不施加电压 试验后电容恢复：2 小时，25±3℃ Test temperature: 40±2℃ Humidity: 93±3%RH duration: 500+24/-0 hours Voltage: 400VAC(U <sub>R</sub> )for one half of the samples. After test the capacitors shall be recovered for 2hours at 25±3℃
		电容量 Capacitance	$\Delta=(C_X-C_0)/C_0$ $\Delta: \pm 15\%$	
		损耗角 tanδ dissipation factor	Y5P: ≤0.025 Y5U: ≤0.025 Y5V: ≤0.025	
		耐电压 voltage proof	accorder 4.2.1	
		绝缘电阻 Insulation resistance	≥5000MΩ $\Delta=(R_X-R_0)/R_0$ $\Delta > 50\%$	
15	4.13	无永久性击穿或飞弧。No permanent breakdown or flashover during the test period.		脉冲电压：8.0KV

	脉冲电压 Impulse voltage	监视器出现有三次连续脉冲波形表示电容器未发生自愈性击穿，可停止施加脉冲，判为合格。If any three successive impulses are shown by the oscilloscope monitor to have had a waveform indicating that no self-healing breakdowns or flashovers have taken place in the capacitor, then no further impulses shall be applied and the capacitor shall be counted as conforming. 施加 24 次脉冲后电容器有三次或更多次的波形表示未发生自愈性击穿，判为合格。 If all 24 impulses have been applied to the capacitor and 3 or more of them are of a waveform indicating that no self-healing breakdowns or flashovers have occurred, then the capacitor shall be counted as conforming. 规定波形的脉冲少于三次，则判电容器失效不合格。If less than three impulses are of the required waveform, then the capacitor shall be counted as a nonconforming item.	脉冲间隔时间：>10 秒 脉冲次数：24 次（脉冲极性相同） Peak impulse voltage:8.0KV Impulses distance :>10seconds Impulses times:24	
16	4.14 耐久性 Endurance	外观检查 visual examination  容量 Capacitance  损耗角 tanδ dissipation factor  耐电压 voltage proof  绝缘电阻 Insulation resistance	无可见损伤 No visible damage  $\Delta=(C_x-C_0)/C_0$ $\Delta:\pm 20\%$  Y5P: ≤0.025 Y5U: ≤0.025 Y5V: ≤0.025  accorder 4.2.1  $\geq 5000M\Omega$ $\Delta=(R_x-R_0)/R_0$ $\Delta>50\%$	试验温度：125±3℃ 持续时间：1000 小时 施加电压：680VAC(1.7UR) 试验后电容恢复：24 小时，25±3℃ Test temperature: 125±3℃ Duration: 1000+48/-0hours test voltage: 680VAC(1.7UR), except that once every hour the voltage shall be increased to 1000v r.m.s. for 0.1s. Each of these voltage shall be applied To each capacitor individually through a resistor of 47Ω±5%. After test the capacitors shall be recovered for 24±2hours at 25±3℃
17	4.15 充电和放电 Charge and discharge	容量 Capacitance  损耗角 tanδ dissipation factor	$\Delta=(C_x-C_0)/C_0$ $\Delta:\pm 20\%$  Y5P: ≤0.025 Y5U: ≤0.025 Y5V: ≤0.025	充电电压：800VAC(2UR) 充放电循环次数：10000 次 充放电速率：1 次/秒 方法：电容器的一次充电和放电为一次循环。电容器需经过一个电阻器充电和另一电阻器放电，放电速率 100V/us。



		耐电压 voltage proof	accorder 4.2.1	Charge voltage: 800VAC(2UR) number of cycles:10000 the rate of approximately: one operation per second. Each cycle shall consist of charging and discharging the capacitor. Each capacitor shall be individually charged by applying the test voltage through a resistor with the value $R = \frac{220 \times 10^{-6}}{C_R} \Omega$															
		绝缘电阻 Insulation resistance	$\geq 5000M\Omega$ $\Delta = (R_x - R_0) / R_0$ $\Delta > 50\%$																
18	4.17 阻燃性试验 Passive flammability	阻燃类别 B: 不超过规定的燃烧时间, 垫纸不引燃。 Category: B The burning time of any specimen shall not exceed the time specified. Burning droplets or glowing parts falling down shall not ignite the tissue paper.		Category: B															
				<table border="1"> <thead> <tr> <th>体积 Volume ranges mm<sup>3</sup></th> <th>施加火焰时间 Fame time</th> <th>最大燃烧时间 Maximum burning time</th> </tr> </thead> <tbody> <tr> <td>V≤250</td> <td>10S</td> <td>10S</td> </tr> <tr> <td>250&lt;V≤500</td> <td>20S</td> <td>10S</td> </tr> <tr> <td>500&lt;V≤1750</td> <td>30S</td> <td>10S</td> </tr> <tr> <td>V&gt;1750</td> <td>60S</td> <td>10S</td> </tr> </tbody> </table>	体积 Volume ranges mm <sup>3</sup>	施加火焰时间 Fame time	最大燃烧时间 Maximum burning time	V≤250	10S	10S	250<V≤500	20S	10S	500<V≤1750	30S	10S	V>1750	60S	10S
				体积 Volume ranges mm <sup>3</sup>	施加火焰时间 Fame time	最大燃烧时间 Maximum burning time													
				V≤250	10S	10S													
				250<V≤500	20S	10S													
500<V≤1750	30S	10S																	
V>1750	60S	10S																	
19	4.19 电容器的耐溶剂 Component solvent resistance	电容本体无可见损伤 电性能测试符合要求标准 4.2.1~4.2.5 No visible damage. Performance accorder 4.2.1~4.2.5		使用溶剂: 30±5%异丙醇和 70±5%三氯三氟乙烷的混合物 溶剂温度: 23±5℃ 方法: 将电容浸于溶剂中 5±0.5S 恢复时间: 48 小时 Solvent to be used: 30±5% isopropyl alcohol and 70±5% fluxional compound Solvent temperature: 23±5℃ The capacitor shall be immersed in solvent for 5±0.5seconds. Recovery time: 48hours															
20	4.20 标志耐溶剂 Solvent resistance of the marking	标志清晰 The marking shall be legible		使用溶剂: 30±5%异丙醇和 70±5%三氯三氟乙烷的混合物 溶剂温度: 23±5℃ 方法: 将电容浸于溶剂中并用脱脂棉擦拭标志 10 次 Solvent to be used: 30±5% isopropyl alcohol and 70±5% fluxional compound Solvent temperature: 23±5℃ The capacitors shall be immersed in solvent and its mark shall be wiped with pledget for 10times.															

### 13. 标志图案 Marking design

Design 4



KNSCHA	trademark
JT	type/model reference
102	code of capacitance (three design)
M	code of tolerance
X1 440V~ Y1 400V~	rated voltage
EN EC 10 DVE CQC C UL US	a.c. mark

### 14. 包装 Packing

A: 散装 bulk (1000PCS/bag)

L\*H\*W=35\*14\*14cm

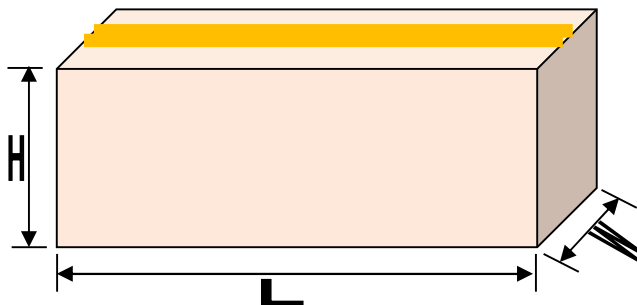

B: 编带 TAPE (1000PCS/BOX)

L\*H\*W=33.5\*25\*4.2cm

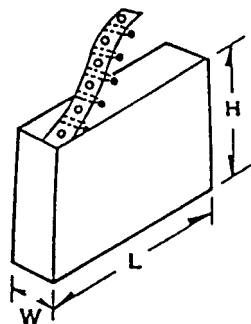

编带脚距 7.5mm/10mm Capacitors on tape type pitch 7.5mm /10mm

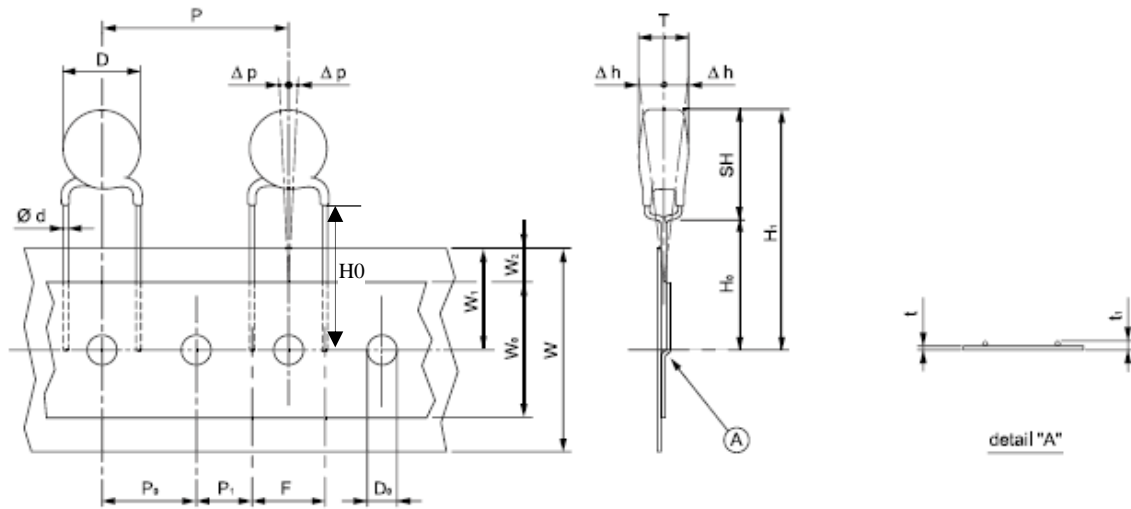

参数 Parameter	符号 Symbol	尺寸规格 Taping Specifications(unit: mm)		
		Pitch 7.5	Pitch 10	Tolerance
线径 lead diameter	Φd	0.55	0.55	±0.05
电容间距 pitch between capacitors	p	12.7	25.4	±1.0
孔间距 feed-hole pitch	P <sub>0</sub>	12.7	12.7	±0.3
孔中心到脚中心距离 feed-hole centre to lead centre	P <sub>1</sub>	8.95	7.62	±0.7
脚距 lead spacing	F	7.5	10.0	±1.0
本体前后偏斜误差 component alignment	Δh	0	0	±3.0
本体左右偏斜 deviation along tape, left or right	Δp	0	0	±1.3
纸带宽度 tape width	w	18.0	18.0	±0.5
热熔胶带宽度 hold-down tape width	W <sub>0</sub>	10.0	10.0	-
孔中心到纸带边宽度 hole position	W <sub>1</sub>	9.0	9.0	±0.5
留边宽度 hold-down tape position	W <sub>2</sub>	3.0	3.0	-
编带脚长 seated height to tape centre	H <sub>0</sub>	20.0	20.0	±1.0
电容顶部到孔中心总体高度 maximum component height	H <sub>1</sub>	37.0	37.0	-
孔径 feed-hole diameter	D <sub>0</sub>	4.0	4.0	±0.2
编带纸带总厚度 total tape thickness	t	0.50	0.50	±0.2
编带总厚度 maximum thickness of tape and wires	t <sub>1</sub>	1.0	1.0	-

## 15. 贮存 Storage

防潮，防尘，防压，防跌倒，防酸碱物质，避免阳光直射和结露。

电容器可在额定的气候类别温度范围内短期（3个月）贮存。

电容器长时间贮存时需要满足下列条件：

- 贮存温度：-25 to +40°C
- 贮存湿度：不超过 80%，并无结露现象
- 贮存期限：最大 12 个月

The capacitors are must not stored in a corrosive atmosphere, where sulphide or chloride gas, acid, alkali or salt are present. Exposure of the components to moisture, should be avoided. Capacitors can be stored for short periods at any temperature within the entire range of category temperature. For long storage periods, however, the following conditions should be observed:

- Storage temperature: -25 to +40°C
- Maximum relative humidity 80%, no dew allowed on the capacitor.
- Maximum duration 12 months.

## 16. 敬告和警告 Cautions and warnings

1. 用户进行的重复耐电压试验可能损坏电容器，故试验后的电容器不可以当合格品再使用。

2. 电容器在 PCB 板上安装时要求 PCB 板孔径需与电容器脚距相吻合，相反可能会导致电容器与 PCB 板焊接不良，电容器引脚断裂或本体破坏而损坏电容器。

3. 避免任何挤压，弯折，外部撞击。

4. 在电容器上进行树脂成型时，应事先咨询我司相关技术人员。

5. 焊接于 PCB 板的电容器不可用力移动或将本体用力倾斜。

6. 不可于焊接于 PCB 板后的电容将板提取，可能破坏电容焊接和包封层破损。

1. Attention is drawn to the fact that repetition of the voltage proof test by the user may damage the capacitor.

2. Do not place the capacitor a PC board whose hole space differs from the specified lead space.

3. Avoid any compressive, tensile or flexural stress.

4. Please consult us first if you wish to embed the capacitor in plastic resins.

5. Do not move the capacitor after it has been soldered to the board.

6. Do not pick up the PC board by the soldered capacitor.

## 17. 交流陶瓷电容器常识 General knowledge for AC ceramic capacitors

### 1. 电容量和损耗测试条件：

1.1 环境温湿度要求：25±3°C，55±30%RH

1.2 测试仪器测试电压和频率：1.0±0.2V，1KHz±20Hz

1.3 测试前产品应于测试环境中存放两小时以上。

The test conditions for capacitance and Dissipation factor(tanδ):

1.1 Environment: temperature: 25±3°C humidity: 55±30%RH

1.2 Voltage and frequency for test apparatus: 1.0±0.2V，1KHz±20Hz

1.3 Capacitor shall be store in environment for test more than two hours before test.

## 2. 测试项目要求 The test method

### 2.1 容量和损耗测试 For capacitance and dissipation factor( $\tan\delta$ ) :

2.1.1 用测试夹具紧密接触或夹住电容两脚进行测试读数，不可用手拿着电容本体进行测试。因手温传给电容本体后会影晌电容的容量和损耗，造成测试结果有出入而引起误判。The capacitor is tested after be clamped with the test tool, can't take the capacitor's body for test with hand. Capacitance and dissipation factor are not exact because of temperature in hand and test result is not right.

2.1.2 耐压测试后的产品在进行容量和损耗测试前必须是电容已经放置 24 小时以上，并且在测试时需将电容两引脚进行短路放电，避免残余电量损坏测试仪表。The capacitor's capacitance and Dissipation factor after voltage tested may not test before the capacitor is stored for 24 hours after voltage test. The capacitor must be discharge between leads before test, or else voltage of remainder attaint test apparatus.

### 2.2 耐压测试 For voltage proof:

先调节好测试用耐压仪的测试电压性质，数值，最大电流和测试时间，再用测试仪两电源输出端夹子夹住电容的两支引脚，且两夹具的内间距不能小于电容脚距（若两夹具的内间距小于电容脚距时，在充电测试中会因爬电距离过小产生飞弧，瞬间在电容内部产生大电流而破坏电容结构。Charge to capacitor after AC or DC Voltage, value, time and current are seted in test apparatus, clamping capacitor's lead with clamp for test apparatus output. Space between clamps for test apparatus output must meet standard, or else flashover will be happened between two leads if space is too small. Capacitor's configuration was be destroyed if great current will be happened in capacitor for moment.