

MC74LCX541

Low-Voltage CMOS Octal Buffer Flow Through Pinout

With 5 V-Tolerant Inputs and Outputs (3-State, Non-Inverting)

The MC74LCX541 is a high performance, non-inverting octal buffer operating from a 2.3 to 3.6 V supply. This device is similar in function to the MC74LCX244, while providing flow through architecture. High impedance TTL compatible inputs significantly reduce current loading to input drivers while TTL compatible outputs offer improved switching noise performance. A V_I specification of 5.5 V allows MC74LCX541 inputs to be safely driven from 5 V devices. The MC74LCX541 is suitable for memory address driving and all TTL level bus oriented transceiver applications.

Current drive capability is 24 mA at the outputs. The Output Enable ($\overline{OE1}$, $\overline{OE2}$) inputs, when HIGH, disables the output by placing them in a HIGH Z condition.

Features

- Designed for 2.3 to 3.6 V V_{CC} Operation
- 5 V Tolerant – Interface Capability With 5 V TTL Logic
- Supports Live Insertion and Withdrawal
- I_{OFF} Specification Guarantees High Impedance When $V_{CC} = 0$ V
- LVTTTL Compatible
- LVCMOS Compatible
- 24 mA Balanced Output Sink and Source Capability
- Near Zero Static Supply Current in All Three Logic States (10 μ A) Substantially Reduces System Power Requirements
- Latchup Performance Exceeds 500 mA
- ESD Performance:
 - ◆ Human Body Model > 2000 V
 - ◆ Machine Model > 200 V
- NLV Prefix for Automotive and Other Applications Requiring Unique Site and Control Change Requirements; AEC-Q100 Qualified and PPAP Capable
- These Devices are Pb-Free, Halogen Free/BFR Free and are RoHS Compliant



ON Semiconductor®

<http://onsemi.com>

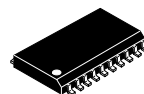

SOIC-20 WB
DW SUFFIX
CASE 751D

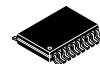

TSSOP-20
DT SUFFIX
CASE 948E

MARKING DIAGRAMS

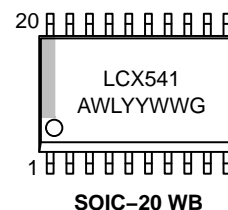

SOIC-20 WB

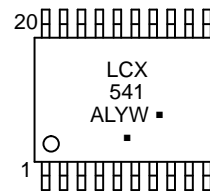

TSSOP-20

A = Assembly Location
L, WL = Wafer Lot
Y, YY = Year
W, WW = Work Week
G or ■ = Pb-Free Package

(Note: Microdot may be in either location)

ORDERING INFORMATION

See detailed ordering and shipping information in the package dimensions section on page 6 of this data sheet.

MC74LCX541

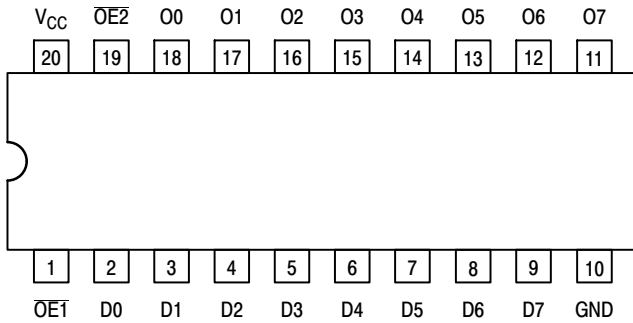

Figure 1. Pinout: 20-Lead (Top View)

PIN NAMES

Pins	Function
$\overline{OE}1$	Output Enable Inputs
Dn	Data Inputs
On	3-State Outputs

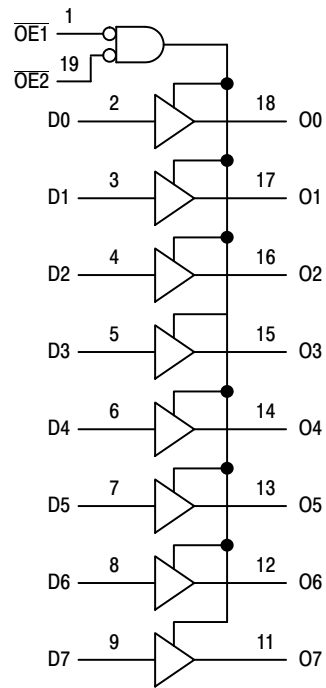

Figure 2. Logic Diagram

TRUTH TABLE

Inputs			Outputs
$\overline{OE}1$	$\overline{OE}2$	Dn	On
L	L	L	L
L	L	H	H
X	H	X	Z
H	X	X	Z

H = High Voltage Level; L = Low Voltage Level; Z = High Impedance State; X = High or Low Voltage Level and Transitions are Acceptable, for I_{CC} reasons, DO NOT FLOAT Inputs

MAXIMUM RATINGS

Symbol	Parameter	Value	Condition	Units
V_{CC}	DC Supply Voltage	-0.5 to +7.0		V
V_I	DC Input Voltage	$-0.5 \leq V_I \leq +7.0$		V
V_O	DC Output Voltage	$-0.5 \leq V_O \leq +7.0$	Output in 3-State	V
		$-0.5 \leq V_O \leq V_{CC} + 0.5$	(Note 1)	V
I_{IK}	DC Input Diode Current	-50	$V_I < GND$	mA
I_{OK}	DC Output Diode Current	-50	$V_O < GND$	mA
		+50	$V_O > V_{CC}$	mA
I_O	DC Output Source/Sink Current	± 50		mA
I_{CC}	DC Supply Current Per Supply Pin	± 100		mA
I_{GND}	DC Ground Current Per Ground Pin	± 100		mA
T_{STG}	Storage Temperature Range	-65 to +150		$^{\circ}C$
MSL	Moisture Sensitivity		Level 1	

Stresses exceeding those listed in the Maximum Ratings table may damage the device. If any of these limits are exceeded, device functionality should not be assumed, damage may occur and reliability may be affected.

1. Output in HIGH or LOW State. I_O absolute maximum rating must be observed.

MC74LCX541

RECOMMENDED OPERATING CONDITIONS

Symbol	Parameter	Min	Typ	Max	Units
V_{CC}	Supply Voltage Operating Data Retention Only	2.0 1.5	3.3 3.3	3.6 3.6	V
V_I	Input Voltage	0		5.5	V
V_O	Output Voltage (HIGH or LOW State) (3-State)	0 0		V_{CC} 5.5	V
I_{OH}	HIGH Level Output Current, $V_{CC} = 3.0\text{ V} - 3.6\text{ V}$			-24	mA
I_{OL}	LOW Level Output Current, $V_{CC} = 3.0\text{ V} - 3.6\text{ V}$			24	mA
I_{OH}	HIGH Level Output Current, $V_{CC} = 2.7\text{ V} - 3.0\text{ V}$			-12	mA
I_{OL}	LOW Level Output Current, $V_{CC} = 2.7\text{ V} - 3.0\text{ V}$			12	mA
T_A	Operating Free-Air Temperature	-40		+85	°C
$\Delta t/\Delta V$	Input Transition Rise or Fall Rate, V_{IN} from 0.8 V to 2.0 V, $V_{CC} = 3.0\text{ V}$	0		10	ns/V

Functional operation above the stresses listed in the Recommended Operating Ranges is not implied. Extended exposure to stresses beyond the Recommended Operating Ranges limits may affect device reliability.

DC ELECTRICAL CHARACTERISTICS

Symbol	Characteristic	Condition	$T_A = -40^\circ\text{C to } +85^\circ\text{C}$		Units
			Min	Max	
V_{IH}	HIGH Level Input Voltage (Note 2)	$2.7\text{ V} \leq V_{CC} \leq 3.6\text{ V}$	2.0		V
V_{IL}	LOW Level Input Voltage (Note 2)	$2.7\text{ V} \leq V_{CC} \leq 3.6\text{ V}$		0.8	V
V_{OH}	HIGH Level Output Voltage	$2.7\text{ V} \leq V_{CC} \leq 3.6\text{ V}; I_{OH} = -100\ \mu\text{A}$	$V_{CC} - 0.2$		V
		$V_{CC} = 2.7\text{ V}; I_{OH} = -12\text{ mA}$	2.2		
		$V_{CC} = 3.0\text{ V}; I_{OH} = -18\text{ mA}$	2.4		
		$V_{CC} = 3.0\text{ V}; I_{OH} = -24\text{ mA}$	2.2		
V_{OL}	LOW Level Output Voltage	$2.7\text{ V} \leq V_{CC} \leq 3.6\text{ V}; I_{OL} = 100\ \mu\text{A}$		0.2	V
		$V_{CC} = 2.7\text{ V}; I_{OL} = 12\text{ mA}$		0.4	
		$V_{CC} = 3.0\text{ V}; I_{OL} = 16\text{ mA}$		0.4	
		$V_{CC} = 3.0\text{ V}; I_{OL} = 24\text{ mA}$		0.55	
I_{OZ}	3-State Output Current	$V_{CC} = 3.6\text{ V}, V_{IN} = V_{IH}\text{ or } V_{IL}, V_{OUT} = 0\text{ to } 5.5\text{ V}$		± 5	μA
I_{OFF}	Power Off Leakage Current	$V_{CC} = 0, V_{IN} = 5.5\text{ V or } V_{OUT} = 5.5\text{ V}$		10	μA
I_{IN}	Input Leakage Current	$V_{CC} = 3.6\text{ V}, V_{IN} = 5.5\text{ V or GND}$		± 5	μA
I_{CC}	Quiescent Supply Current	$V_{CC} = 3.6\text{ V}, V_{IN} = 5.5\text{ V or GND}$		10	μA
ΔI_{CC}	Increase in I_{CC} per Input	$2.3 \leq V_{CC} \leq 3.6\text{ V}; V_{IH} = V_{CC} - 0.6\text{ V}$		500	μA

Product parametric performance is indicated in the Electrical Characteristics for the listed test conditions, unless otherwise noted. Product performance may not be indicated by the Electrical Characteristics if operated under different conditions.

2. These values of V_I are used to test DC electrical characteristics only.

MC74LCX541

AC ELECTRICAL CHARACTERISTICS ($t_R = t_F = 2.5$ ns; $C_L = 50$ pF; $R_L = 500 \Omega$)

Symbol	Parameter	Waveform	Limits			Units
			$T_A = -40^\circ\text{C to } +85^\circ\text{C}$			
			$V_{CC} = 3.0$ V to 3.6 V		$V_{CC} = 2.7$ V	
			Min	Max	Max	
t_{PLH} t_{PHL}	Propagation Delay Input to Output	1	1.5 1.5	6.5 6.5	7.5 7.5	ns
t_{PZH} t_{PZL}	Output Enable Time to High and Low Level	2	1.5 1.5	8.5 8.5	9.5 9.5	ns
t_{PHZ} t_{PLZ}	Output Disable Time From High and Low Level	2	1.5 1.5	7.5 7.5	8.5 8.5	ns
t_{OSHL} t_{OSLH}	Output-to-Output Skew (Note 3)			1.0 1.0		ns

3. Skew is defined as the absolute value of the difference between the actual propagation delay for any two separate outputs of the same device. The specification applies to any outputs switching in the same direction, either HIGH-to-LOW (t_{OSHL}) or LOW-to-HIGH (t_{OSLH}); parameter guaranteed by design.

DYNAMIC SWITCHING CHARACTERISTICS

Symbol	Characteristic	Condition	$T_A = +25^\circ\text{C}$			Units
			Min	Typ	Max	
V_{OLP}	Dynamic LOW Peak Voltage (Note 4)	$V_{CC} = 3.3$ V, $C_L = 50$ pF, $V_{IH} = 3.3$ V, $V_{IL} = 0$ V		0.8		V
V_{OLV}	Dynamic LOW Valley Voltage (Note 4)	$V_{CC} = 3.3$ V, $C_L = 50$ pF, $V_{IH} = 3.3$ V, $V_{IL} = 0$ V		0.8		V

4. Number of outputs defined as "n". Measured with "n-1" outputs switching from HIGH-to-LOW or LOW-to-HIGH. The remaining output is measured in the LOW state.

CAPACITIVE CHARACTERISTICS

Symbol	Parameter	Condition	Typical	Units
C_{IN}	Input Capacitance	$V_{CC} = 3.3$ V, $V_I = 0$ V or V_{CC}	7	pF
C_{OUT}	Output Capacitance	$V_{CC} = 3.3$ V, $V_I = 0$ V or V_{CC}	8	pF
C_{PD}	Power Dissipation Capacitance	10 MHz, $V_{CC} = 3.3$ V, $V_I = 0$ V or V_{CC}	25	pF

MC74LCX541

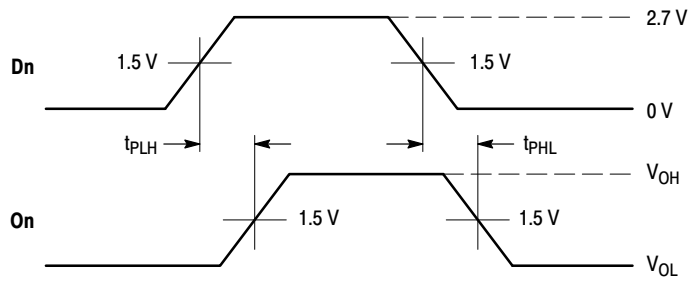

WAVEFORM 1 - PROPAGATION DELAYS

$t_R = t_F = 2.5$ ns, 10% to 90%; $f = 1$ MHz; $t_W = 500$ ns

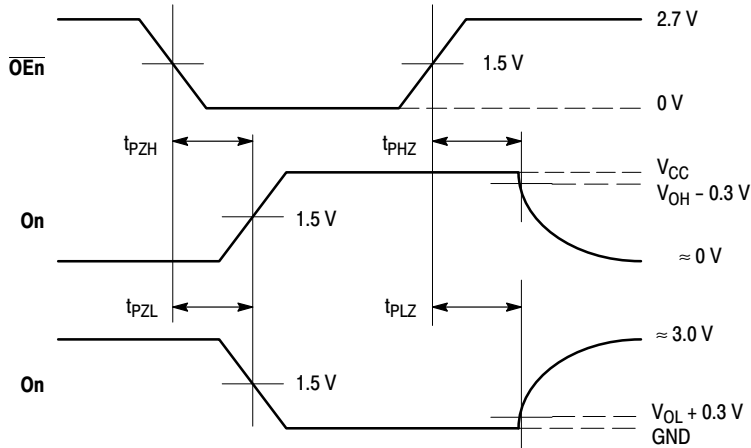

WAVEFORM 2 - OUTPUT ENABLE AND DISABLE TIMES

$t_R = t_F = 2.5$ ns, 10% to 90%; $f = 1$ MHz; $t_W = 500$ ns

Figure 3. AC Waveforms

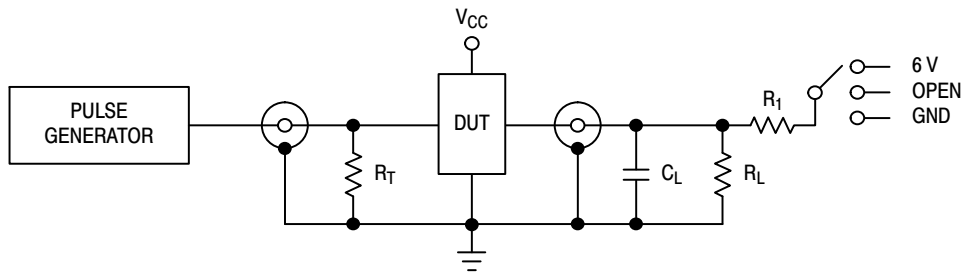

Test	Switch
t_{PLH} , t_{PHL}	Open
t_{PZL} , t_{PLZ}	6 V
Open Collector/Drain t_{PLH} and t_{PHL}	6 V
t_{PZH} , t_{PHZ}	GND

$C_L = 50$ pF or equivalent (Includes jig and probe capacitance)

$R_L = R_1 = 500 \Omega$ or equivalent

$R_T = Z_{OUT}$ of pulse generator (typically 50Ω)

Figure 4. Test Circuit

MC74LCX541

ORDERING INFORMATION

Device	Package	Shipping†
MC74LCX541DWR2G	SOIC-20 (Pb-Free)	1000 Tape & Reel
NLV74LCX541DWR2G* (In Development)	SOIC-20 (Pb-Free)	1000 Tape & Reel
MC74LCX541DWG	SOIC-20 (Pb-Free)	38 Units / Rail
NLV74LCX541DWG* (In Development)	SOIC-20 (Pb-Free)	38 Units / Rail
MC74LCX541DTG	TSSOP-20 (Pb-Free)	75 Units / Rail
NLV74LCX541DTG* (In Development)	TSSOP-20 (Pb-Free)	75 Units / Rail
MC74LCX541DTR2G	TSSOP-20 (Pb-Free)	2500 Tape & Reel
NLV74LCX541DTR2G* (In Development)	TSSOP-20 (Pb-Free)	2500 Tape & Reel

†For information on tape and reel specifications, including part orientation and tape sizes, please refer to our Tape and Reel Packaging Specifications Brochure, BRD8011/D.

*NLV Prefix for Automotive and Other Applications Requiring Unique Site and Control Change Requirements; AEC-Q100 Qualified and PPAP Capable.

MECHANICAL CASE OUTLINE

PACKAGE DIMENSIONS

ON Semiconductor®

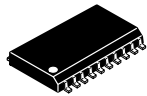

SCALE 1:1

SOIC-20 WB
CASE 751D-05
ISSUE H

DATE 22 APR 2015

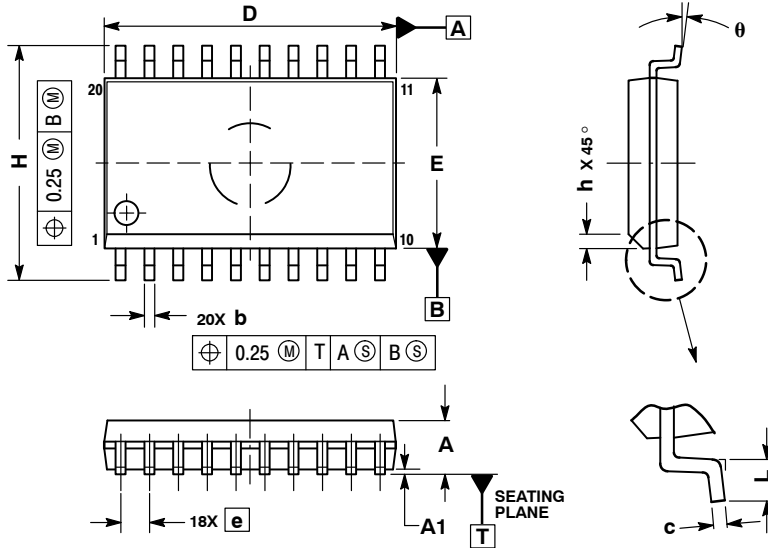

NOTES:

1. DIMENSIONS ARE IN MILLIMETERS.
2. INTERPRET DIMENSIONS AND TOLERANCES PER ASME Y14.5M, 1994.
3. DIMENSIONS D AND E DO NOT INCLUDE MOLD PROTRUSION.
4. MAXIMUM MOLD PROTRUSION 0.15 PER SIDE.
5. DIMENSION B DOES NOT INCLUDE DAMBAR PROTRUSION. ALLOWABLE PROTRUSION SHALL BE 0.13 TOTAL IN EXCESS OF B DIMENSION AT MAXIMUM MATERIAL CONDITION.

DIM	MILLIMETERS	
	MIN	MAX
A	2.35	2.65
A1	0.10	0.25
b	0.35	0.49
c	0.23	0.32
D	12.65	12.95
E	7.40	7.60
e	1.27 BSC	
H	10.05	10.55
h	0.25	0.75
L	0.50	0.90
θ	0°	7°

GENERIC MARKING DIAGRAM*

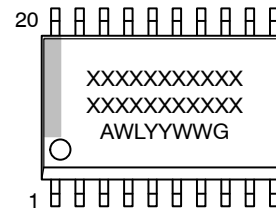

- XXXXXX = Specific Device Code
- A = Assembly Location
- WL = Wafer Lot
- YY = Year
- WW = Work Week
- G = Pb-Free Package

RECOMMENDED SOLDERING FOOTPRINT*

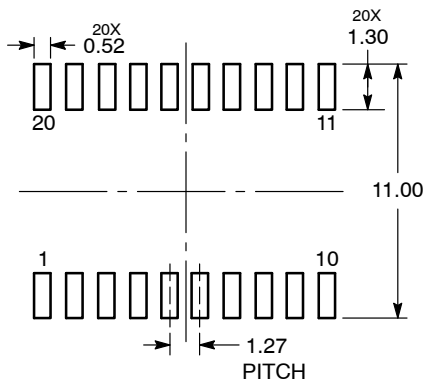

DIMENSIONS: MILLIMETERS

*For additional information on our Pb-Free strategy and soldering details, please download the ON Semiconductor Soldering and Mounting Techniques Reference Manual, SOLDERRM/D.

*This information is generic. Please refer to device data sheet for actual part marking. Pb-Free indicator, "G" or microdot "▪", may or may not be present.

DOCUMENT NUMBER:	98ASB42343B	Electronic versions are uncontrolled except when accessed directly from the Document Repository. Printed versions are uncontrolled except when stamped "CONTROLLED COPY" in red.
DESCRIPTION:	SOIC-20 WB	PAGE 1 OF 1

ON Semiconductor and are trademarks of Semiconductor Components Industries, LLC dba ON Semiconductor or its subsidiaries in the United States and/or other countries. ON Semiconductor reserves the right to make changes without further notice to any products herein. ON Semiconductor makes no warranty, representation or guarantee regarding the suitability of its products for any particular purpose, nor does ON Semiconductor assume any liability arising out of the application or use of any product or circuit, and specifically disclaims any and all liability, including without limitation special, consequential or incidental damages. ON Semiconductor does not convey any license under its patent rights nor the rights of others.

MECHANICAL CASE OUTLINE

PACKAGE DIMENSIONS

ON Semiconductor®

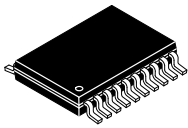

TSSOP-20 WB
CASE 948E
ISSUE D

DATE 17 FEB 2016

SCALE 2:1

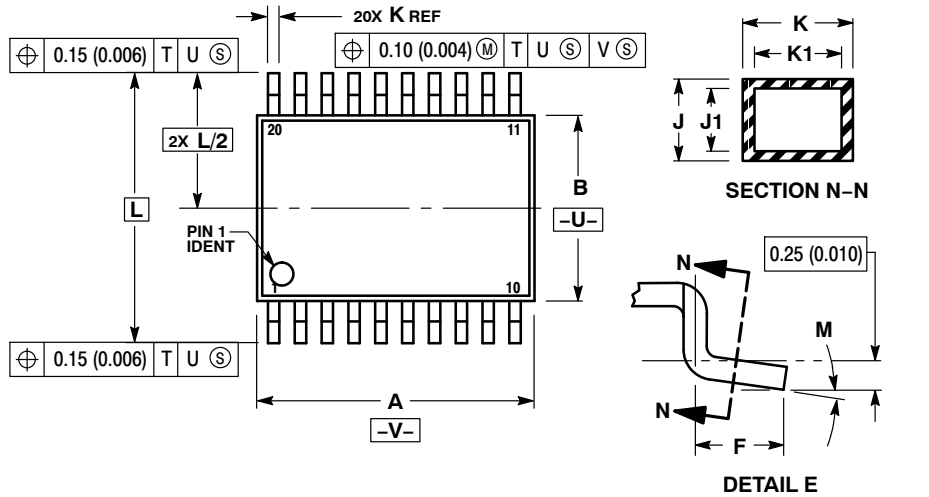

NOTES:

1. DIMENSIONING AND TOLERANCING PER ANSI Y14.5M, 1982.
2. CONTROLLING DIMENSION: MILLIMETER.
3. DIMENSION A DOES NOT INCLUDE MOLD FLASH, PROTRUSIONS OR GATE BURRS. MOLD FLASH OR GATE BURRS SHALL NOT EXCEED 0.15 (0.006) PER SIDE.
4. DIMENSION B DOES NOT INCLUDE INTERLEAD FLASH OR PROTRUSION. INTERLEAD FLASH OR PROTRUSION SHALL NOT EXCEED 0.25 (0.010) PER SIDE.
5. DIMENSION K DOES NOT INCLUDE DAMBAR PROTRUSION. ALLOWABLE DAMBAR PROTRUSION SHALL BE 0.08 (0.003) TOTAL IN EXCESS OF THE K DIMENSION AT MAXIMUM MATERIAL CONDITION.
6. TERMINAL NUMBERS ARE SHOWN FOR REFERENCE ONLY.
7. DIMENSION A AND B ARE TO BE DETERMINED AT DATUM PLANE -W-.

DIM	MILLIMETERS		INCHES	
	MIN	MAX	MIN	MAX
A	6.40	6.60	0.252	0.260
B	4.30	4.50	0.169	0.177
C	---	1.20	---	0.047
D	0.05	0.15	0.002	0.006
F	0.50	0.75	0.020	0.030
G	0.65 BSC		0.026 BSC	
H	0.27	0.37	0.011	0.015
J	0.09	0.20	0.004	0.008
J1	0.09	0.16	0.004	0.006
K	0.19	0.30	0.007	0.012
K1	0.19	0.25	0.007	0.010
L	6.40 BSC		0.252 BSC	
M	0°	8°	0°	8°

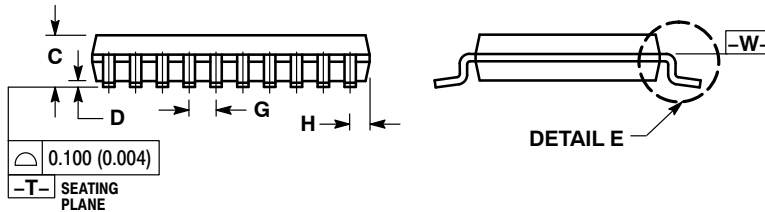

SOLDERING FOOTPRINT

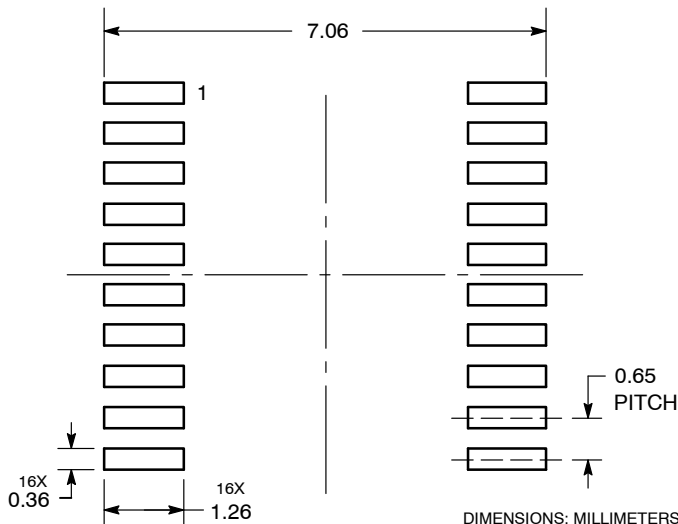

GENERIC MARKING DIAGRAM*

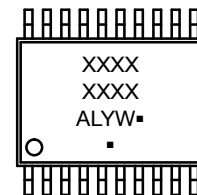

- A = Assembly Location
- L = Wafer Lot
- Y = Year
- W = Work Week
- = Pb-Free Package

(Note: Microdot may be in either location)

*This information is generic. Please refer to device data sheet for actual part marking. Pb-Free indicator, "G" or microdot "▪", may or may not be present.

DOCUMENT NUMBER:	98ASH70169A	Electronic versions are uncontrolled except when accessed directly from the Document Repository. Printed versions are uncontrolled except when stamped "CONTROLLED COPY" in red.
DESCRIPTION:	TSSOP-20 WB	PAGE 1 OF 1

ON Semiconductor and ON are trademarks of Semiconductor Components Industries, LLC dba ON Semiconductor or its subsidiaries in the United States and/or other countries. ON Semiconductor reserves the right to make changes without further notice to any products herein. ON Semiconductor makes no warranty, representation or guarantee regarding the suitability of its products for any particular purpose, nor does ON Semiconductor assume any liability arising out of the application or use of any product or circuit, and specifically disclaims any and all liability, including without limitation special, consequential or incidental damages. ON Semiconductor does not convey any license under its patent rights nor the rights of others.

ON Semiconductor and  are trademarks of Semiconductor Components Industries, LLC dba ON Semiconductor or its subsidiaries in the United States and/or other countries. ON Semiconductor owns the rights to a number of patents, trademarks, copyrights, trade secrets, and other intellectual property. A listing of ON Semiconductor's product/patent coverage may be accessed at www.onsemi.com/site/pdf/Patent-Marking.pdf. ON Semiconductor reserves the right to make changes without further notice to any products herein. ON Semiconductor makes no warranty, representation or guarantee regarding the suitability of its products for any particular purpose, nor does ON Semiconductor assume any liability arising out of the application or use of any product or circuit, and specifically disclaims any and all liability, including without limitation special, consequential or incidental damages. Buyer is responsible for its products and applications using ON Semiconductor products, including compliance with all laws, regulations and safety requirements or standards, regardless of any support or applications information provided by ON Semiconductor. "Typical" parameters which may be provided in ON Semiconductor data sheets and/or specifications can and do vary in different applications and actual performance may vary over time. All operating parameters, including "Typicals" must be validated for each customer application by customer's technical experts. ON Semiconductor does not convey any license under its patent rights nor the rights of others. ON Semiconductor products are not designed, intended, or authorized for use as a critical component in life support systems or any FDA Class 3 medical devices or medical devices with a same or similar classification in a foreign jurisdiction or any devices intended for implantation in the human body. Should Buyer purchase or use ON Semiconductor products for any such unintended or unauthorized application, Buyer shall indemnify and hold ON Semiconductor and its officers, employees, subsidiaries, affiliates, and distributors harmless against all claims, costs, damages, and expenses, and reasonable attorney fees arising out of, directly or indirectly, any claim of personal injury or death associated with such unintended or unauthorized use, even if such claim alleges that ON Semiconductor was negligent regarding the design or manufacture of the part. ON Semiconductor is an Equal Opportunity/Affirmative Action Employer. This literature is subject to all applicable copyright laws and is not for resale in any manner.

PUBLICATION ORDERING INFORMATION

LITERATURE FULFILLMENT:

Email Requests to: orderlit@onsemi.com

ON Semiconductor Website: www.onsemi.com

TECHNICAL SUPPORT

North American Technical Support:
Voice Mail: 1 800-282-9855 Toll Free USA/Canada
Phone: 011 421 33 790 2910

Europe, Middle East and Africa Technical Support:

Phone: 00421 33 790 2910

For additional information, please contact your local Sales Representative