



8-bit Atmel Microcontroller with 16/32/64KB In-System Programmable Flash

DATASHEET SUMMARY

Features

- High performance, low power Atmel® AVR® 8-Bit Microcontroller
- Advanced RISC architecture
 - 130 powerful instructions – most single clock cycle execution
 - 32 × 8 general purpose working registers
 - Fully static operation
 - Up to 16MIPS throughput at 16MHz (Atmel ATmega169A/169PA/649A/649P)
 - Up to 20 MIPS throughput at 20MHz (Atmel ATmega329A/329PA/3290A/3290PA/6490A/6490P)
 - On-chip 2-cycle multiplier
- High endurance non-volatile memory segments
 - In-system self-programmable flash program memory
 - 16Kbytes (Atmel ATmega169A/ATmega169PA)
 - 32Kbytes (Atmel ATmega329A/ATmega329PA/ATmega3290A/ATmega3290PA)
 - 64Kbytes (Atmel ATmega649A/ATmega649P/ATmega6490A/ATmega6490P)
 - EEPROM
 - 512bytes (ATmega169A/ATmega169PA)
 - 1Kbytes (ATmega329A/ATmega329PA/ATmega3290A/ATmega3290PA)
 - 2Kbytes (ATmega649A/ATmega649P/ATmega6490A/ATmega6490P)
 - Internal SRAM
 - 1Kbytes (ATmega169A/ATmega169PA)
 - 2Kbytes (ATmega329A/ATmega329PA/ATmega3290A/ATmega3290PA)
 - 4Kbytes (ATmega649A/ATmega649P/ATmega6490A/ATmega6490P)
 - Write/erase cycles: 10,000 flash/100,000 EEPROM
 - Data retention: 20 years at 85°C/100 years at 25°C ⁽¹⁾
 - Optional Boot Code Section with Independent Lock Bits
 - In-System Programming by On-chip Boot Program
 - True read-while-write operation
 - Programming lock for software security
- Atmel QTouch® library support
 - Capacitive touch buttons, sliders and wheels
 - Atmel QTouch and QMatrix acquisition
 - Up to 64 sense channels
- JTAG (IEEE std. 1149.1 compliant) Interface
 - Boundary-scan capabilities according to the JTAG standard
 - Extensive on-chip debug support
 - Programming of Flash, EEPROM, Fuses, and Lock Bits through the JTAG Interface
- Peripheral features
 - 4 × 25 segment LCD driver (ATmega169A/ATmega169PA/ATmega329A/ATmega329PA/ATmega649A/ATmega649P)
 - 4 × 40 segment LCD driver (ATmega3290A/ATmega3290PA/ATmega6490A/ATmega6490P)
 - Two 8-bit Timer/Counters with Separate Prescaler and Compare mode
 - One 16-bit Timer/Counter with Separate Prescaler, Compare mode, and Capture mode

- Real Time Counter with separate oscillator
- Four PWM channels
- 8-channel, 10-bit ADC
- Programmable Serial USART
- Master/Slave SPI Serial Interface
- Universal Serial Interface with Start Condition Detector
- Programmable Watchdog Timer with Separate On-chip oscillator
- On-chip analog comparator
- Interrupt and Wake-up on pin change
- Special microcontroller features
 - Power-on reset and programmable Brown-out detection
 - Internal calibrated oscillator
 - External and internal interrupt sources
 - Five sleep modes: Idle, ADC Noise Reduction, Power-save, Power-down, and Standby
- I/O and packages
 - 54/69 programmable I/O lines
 - 64/100-lead TQFP, 64-pad QFN/MLF, and 64-pad DRQFN
- Speed Grade:
 - ATmega169A/169PA/649A/649P:
 - 0 - 16MHz @ 1.8 - 5.5V
 - ATmega3290A/3290PA/6490A/6490P:
 - 0 - 20MHz @ 1.8 - 5.5V
- Temperature range:
 - -40°C to 85°C industrial
- Ultra-low power consumption (picoPower® devices)
 - Active mode:
 - 1MHz, 1.8V: 215µA
 - 32kHz, 1.8V: 8µA (including oscillator)
 - 32kHz, 1.8V: 25µA (including oscillator and LCD)
 - Power-down mode:
 - 0.1µA at 1.8V
 - Power-save mode:
 - 0.6µA at 1.8V (Including 32kHz RTC)
 - 750nA at 1.8V

1. Pin configurations

1.1 Pinout - 64A (TQFP) and 64M1 (QFN/MLF)

Figure 1-1. Pinout Atmel ATmega169A/ATmega169PA/ATmega329A/ATmega329PA/ATmega649A/ATmega649P.

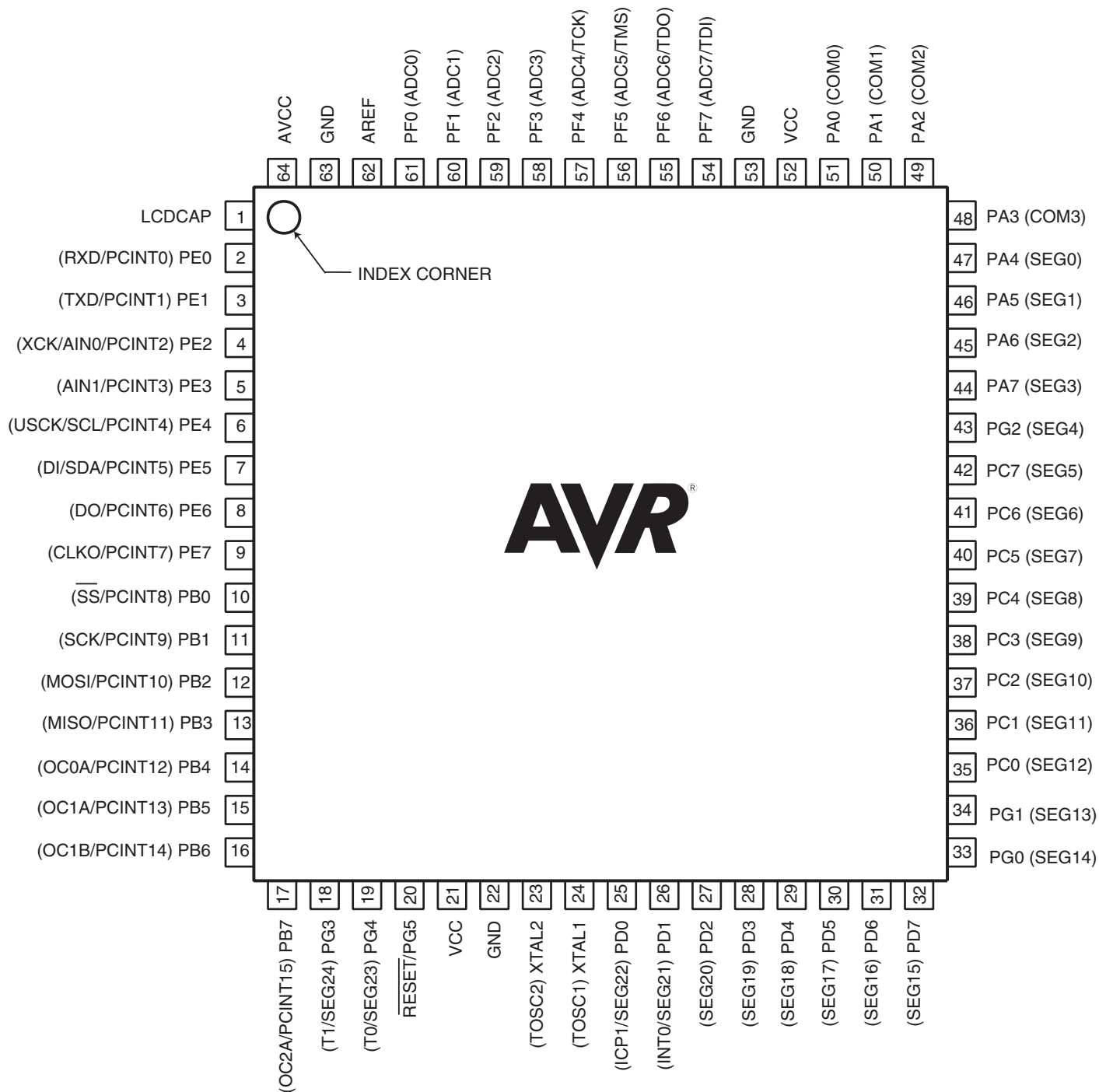

1.2 Pinout - 100A (TQFP)

Figure 1-2. Pinout Atmel ATmega3290A/ATmega3290PA/ATmega6490A/ATmega6490P.

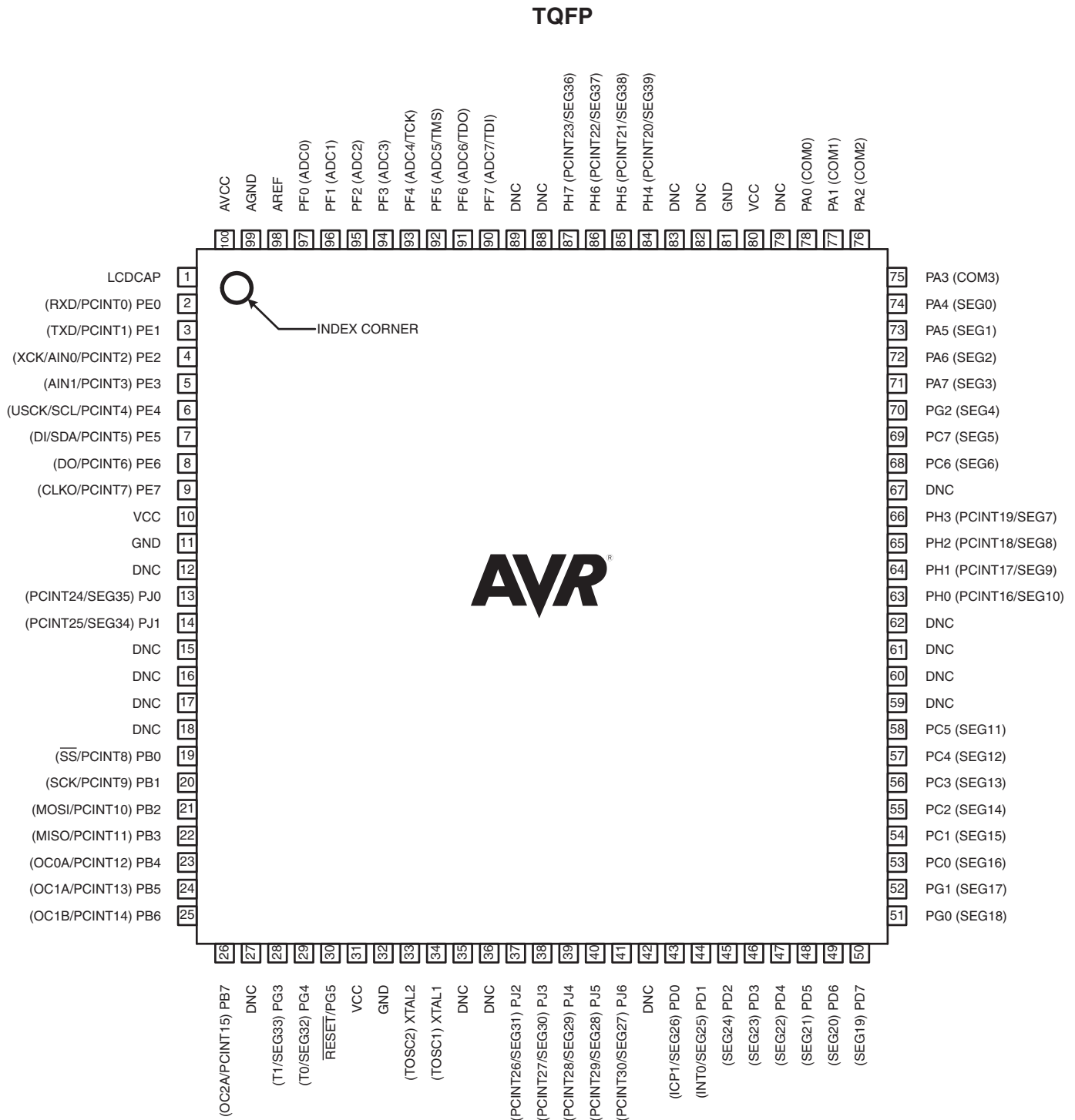

Note: The large center pad underneath the QFN/MLF packages is made of metal and internally connected to GND. It should be soldered or glued to the board to ensure good mechanical stability. If the center pad is left unconnected, the package might loosen from the board.

1.3 Pinout - 64MC (DRQFN)

Figure 1-3. Pinout Atmel ATmega169A/ATmega169PA.

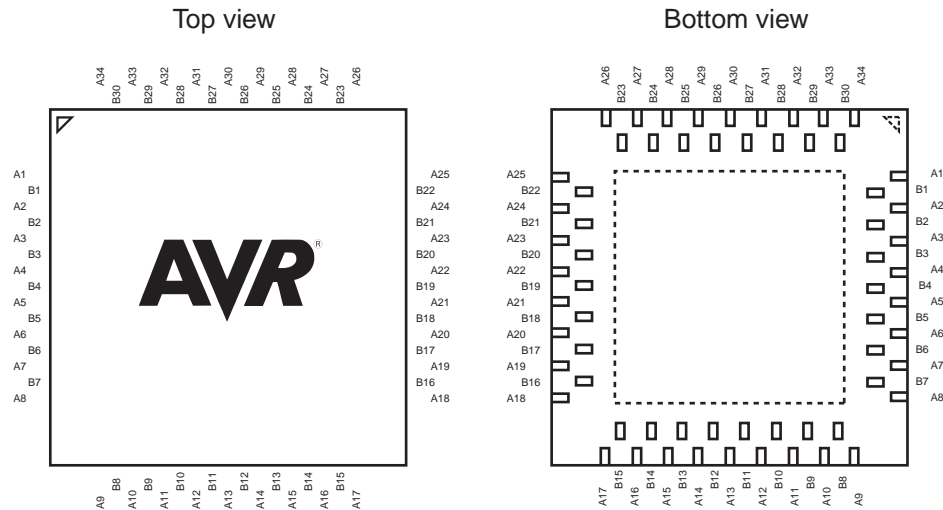

Table 1-1. DRQFN-64 Pinout ATmega169A/ATmega169PA.

	PE0		PB7		PG1 (SEG13)		PA2 (COM2)
	VLCDCAP		PB6		PG0 (SEG14)		PA3 (COM3)
	PE1		PG3		PC0 (SEG12)		PA1 (COM1)
	PE2		PG4		PC1 (SEG11)		PA0 (COM0)
	PE3		$\overline{\text{RESET}}$		PC2 (SEG10)		VCC
	PE4		VCC		PC3 (SEG9)		GND
	PE5		GND		PC4 (SEG8)		PF7
	PE6		XTAL2 (TOSC2)		PC5 (SEG7)		PF6
	PE7		XTAL1 (TOSC1)		PC6 (SEG6)		PF5
	PB0		PD0 (SEG22)		PC7 (SEG5)		PF4
	PB1		PD1 (SEG21)		PG2 (SEG4)		PF3
	PB2		PD2 (SEG20)		PA7 (SEG3)		PF2
	PB3		PD3 (SEG19)		PA6 (SEG2)		PF1
	PB5		PD4 (SEG18)		PA4 (SEG0)		PF0
	PB4		PD5 (SEG17)		PA5 (SEG1)		AREF
			PD7 (SEG15)				AVCC
			PD6 (SEG16)				GND

2. Overview

The Atmel ATmega169A/169PA/329A/329PA/3290A/3290PA/649A/649P/6490A/6490P is a low-power CMOS 8-bit microcontroller based on the Atmel®AVR® enhanced RISC architecture. By executing powerful instructions in a single clock cycle, the ATmega169A/169PA/329A/329PA/3290A/3290PA/649A/649P/6490A/6490P achieves throughputs approaching 1 MIPS per MHz allowing the system designer to optimize power consumption versus processing speed.

2.1 Block diagram

Figure 2-1. Block diagram.

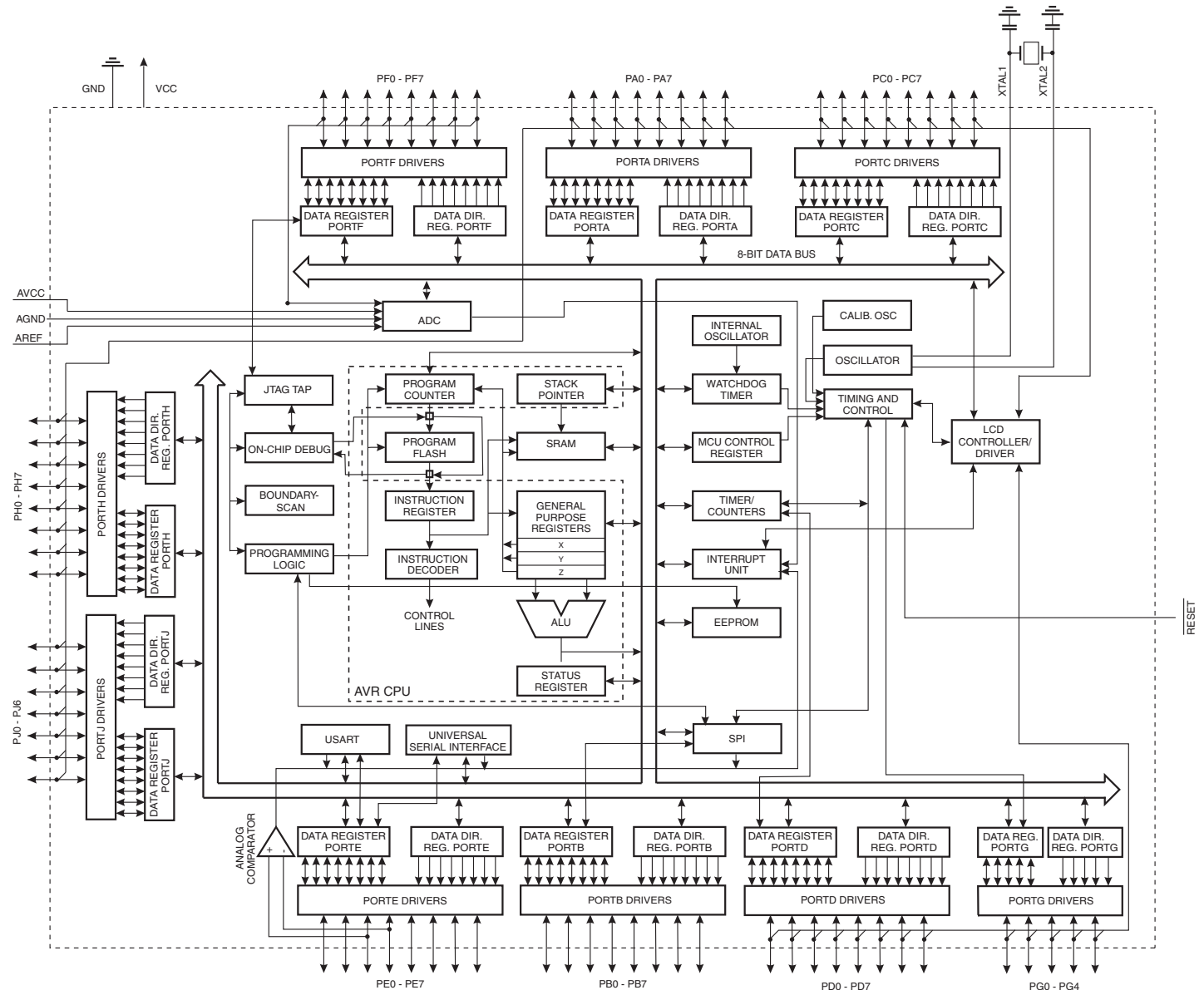

The AVR core combines a rich instruction set with 32 general purpose working registers. All the 32 registers are directly connected to the Arithmetic Logic Unit (ALU), allowing two independent registers to be accessed in one

single instruction executed in one clock cycle. The resulting architecture is more code efficient while achieving throughputs up to ten times faster than conventional CISC microcontrollers.

The Atmel ATmega169A/169PA/329A/329PA/3290A/3290PA/649A/649P/6490A/6490P provides the following features: 16K/32K/64K bytes of In-System Programmable Flash with Read-While-Write capabilities, 512/1K/2K bytes EEPROM, 1K/2K/4K byte SRAM, 54/69 general purpose I/O lines, 32 general purpose working registers, a JTAG interface for Boundary-scan, On-chip Debugging support and programming, a complete On-chip LCD controller with internal contrast control, three flexible Timer/Counters with compare modes, internal and external interrupts, a serial programmable USART, Universal Serial Interface with Start Condition Detector, an 8-channel, 10-bit ADC, a programmable Watchdog Timer with internal Oscillator, an SPI serial port, and five software selectable power saving modes. The Idle mode stops the CPU while allowing the SRAM, Timer/Counters, SPI port, and interrupt system to continue functioning. The Power-down mode saves the register contents but freezes the Oscillator, disabling all other chip functions until the next interrupt or hardware reset. In Power-save mode, the asynchronous timer and the LCD controller continues to run, allowing the user to maintain a timer base and operate the LCD display while the rest of the device is sleeping. The ADC Noise Reduction mode stops the CPU and all I/O modules except asynchronous timer, LCD controller and ADC, to minimize switching noise during ADC conversions. In Standby mode, the XTAL/resonator Oscillator is running while the rest of the device is sleeping. This allows very fast start-up combined with low-power consumption.

Atmel offers the QTouch library for embedding capacitive touch buttons, sliders and wheels functionality into AVR microcontrollers. The patented charge-transfer signal acquisition offers robust sensing and includes fully debounced reporting of touch keys and includes Adjacent Key Suppression[®] (AKS[®]) technology for unambiguous detection of key events. The easy-to-use QTouch Suite toolchain allows you to explore, develop and debug your own touch applications.

The device is manufactured using the Atmel high density non-volatile memory technology. The On-chip In-System re-Programmable (ISP) Flash allows the program memory to be reprogrammed In-System through an SPI serial interface, by a conventional non-volatile memory programmer, or by an On-chip Boot program running on the AVR core. The Boot program can use any interface to download the application program in the Application Flash memory. Software in the Boot Flash section will continue to run while the Application Flash section is updated, providing true Read-While-Write operation.

By combining an 8-bit RISC CPU with In-System Self-Programmable Flash on a monolithic chip, the ATmega169A/169PA/329A/329PA/3290A/3290PA/649A/649P/6490A/6490P is a powerful microcontroller that provides a highly flexible and cost effective solution to many embedded control applications.

The ATmega169A/169PA/329A/329PA/3290A/3290PA/649A/649P/6490A/6490P AVR is supported with a full suite of program and system development tools including: C Compilers, Macro Assemblers, Program Debugger/Simulators, In-Circuit Emulators, and Evaluation kits.

2.2 Comparison between Atmel

ATmega169A/169PA/329A/329PA/649A/649P/3290A/3290PA/6490A/6490P

Table 2-1. Differences between: ATmega169A/169PA/329A/329PA/649A/649P/3290A/3290PA/6490A/6490P.

ATmega169A	16Kbyte	512Bytes	1Kbyte	4 × 25
ATmega169PA	16Kbyte	512Bytes	1Kbyte	4 × 25
ATmega329A	32Kbyte	1Kbyte	2Kbyte	4 × 25
ATmega329PA	32Kbyte	1Kbyte	2Kbyte	4 × 25
ATmega3290A	32Kbytes	1Kbyte	2Kbyte	4 × 40
ATmega3290PA	32Kbyte	1Kbyte	2Kbyte	4 × 40
ATmega649A	64Kbyte	2Kbyte	4Kbyte	4 × 25
ATmega649P	64Kbyte	2Kbyte	4Kbyte	4 × 25
ATmega6490A	64Kbyte	2Kbyte	4Kbyte	4 × 40
ATmega6490P	64Kbyte	2Kbyte	4Kbyte	4 × 40

2.3 Pin descriptions

The following section describes the I/O-pin special functions.

2.3.1 V_{CC}

Digital supply voltage.

2.3.2 GND

Ground.

2.3.3 Port A (PA7...PA0)

Port A is an 8-bit bi-directional I/O port with internal pull-up resistors (selected for each bit). The Port A output buffers have symmetrical drive characteristics with both high sink and source capability. As inputs, Port A pins that are externally pulled low will source current if the pull-up resistors are activated. The Port A pins are tri-stated when a reset condition becomes active, even if the clock is not running.

Port A also serves the functions of various special features of the Atmel ATmega169A/169PA/329A/329PA/3290A/3290PA/649A/649P/6490A/6490P as listed on [page 72](#).

2.3.4 Port B (PB7...PB0)

Port B is an 8-bit bi-directional I/O port with internal pull-up resistors (selected for each bit). The Port B output buffers have symmetrical drive characteristics with both high sink and source capability. As inputs, Port B pins that are externally pulled low will source current if the pull-up resistors are activated. The Port B pins are tri-stated when a reset condition becomes active, even if the clock is not running.

Port B has better driving capabilities than the other ports.

Port B also serves the functions of various special features of the ATmega169A/169PA/329A/329PA/3290A/3290PA/649A/649P/6490A/6490P as listed on [page 73](#).

2.3.5 Port C (PC7...PC0)

Port C is an 8-bit bi-directional I/O port with internal pull-up resistors (selected for each bit). The Port C output buffers have symmetrical drive characteristics with both high sink and source capability. As inputs, Port C pins that are externally pulled low will source current if the pull-up resistors are activated. The Port C pins are tri-stated when a reset condition becomes active, even if the clock is not running.

Port C also serves the functions of special features of the ATmega169A/169PA/329A/329PA/3290A/3290PA/649A/649P/6490A/6490P as listed on [page 76](#).

2.3.6 Port D (PD7...PD0)

Port D is an 8-bit bi-directional I/O port with internal pull-up resistors (selected for each bit). The Port D output buffers have symmetrical drive characteristics with both high sink and source capability. As inputs, Port D pins that are externally pulled low will source current if the pull-up resistors are activated. The Port D pins are tri-stated when a reset condition becomes active, even if the clock is not running.

Port D also serves the functions of various special features of the ATmega169A/169PA/329A/329PA/3290A/3290PA/649A/649P/6490A/6490P as listed on [page 77](#).

2.3.7 Port E (PE7...PE0)

Port E is an 8-bit bi-directional I/O port with internal pull-up resistors (selected for each bit). The Port E output buffers have symmetrical drive characteristics with both high sink and source capability. As inputs, Port E pins that

are externally pulled low will source current if the pull-up resistors are activated. The Port E pins are tri-stated when a reset condition becomes active, even if the clock is not running.

Port E also serves the functions of various special features of the ATmega169A/169PA/329A/329PA/3290A/3290PA/649A/649P/6490A/6490P as listed on [page 79](#).

2.3.8 Port F (PF7...PF0)

Port F serves as the analog inputs to the A/D Converter.

Port F also serves as an 8-bit bi-directional I/O port, if the A/D Converter is not used. Port pins can provide internal pull-up resistors (selected for each bit). The Port F output buffers have symmetrical drive characteristics with both high sink and source capability. As inputs, Port F pins that are externally pulled low will source current if the pull-up resistors are activated. The Port F pins are tri-stated when a reset condition becomes active, even if the clock is not running. If the JTAG interface is enabled, the pull-up resistors on pins PF7(TDI), PF5(TMS), and PF4(TCK) will be activated even if a reset occurs.

Port F also serves the functions of the JTAG interface.

2.3.9 Port G (PG5...PG0)

Port G is a 6-bit bi-directional I/O port with internal pull-up resistors (selected for each bit). The Port G output buffers have symmetrical drive characteristics with both high sink and source capability. As inputs, Port G pins that are externally pulled low will source current if the pull-up resistors are activated. The Port G pins are tri-stated when a reset condition becomes active, even if the clock is not running.

Port G also serves the functions of various special features of the ATmega169A/169PA/329A/329PA/3290A/3290PA/649A/649P/6490A/6490P as listed on [page 83](#).

2.3.10 Port H (PH7...PH0)

Port H is a 8-bit bi-directional I/O port with internal pull-up resistors (selected for each bit). The Port H output buffers have symmetrical drive characteristics with both high sink and source capability. As inputs, Port H pins that are externally pulled low will source current if the pull-up resistors are activated. The Port H pins are tri-stated when a reset condition becomes active, even if the clock is not running.

Port H also serves the functions of various special features of the ATmega3290PA/6490P as listed on [page 85](#).

2.3.11 Port J (PJ6...PJ0)

Port J is a 7-bit bi-directional I/O port with internal pull-up resistors (selected for each bit). The Port J output buffers have symmetrical drive characteristics with both high sink and source capability. As inputs, Port J pins that are externally pulled low will source current if the pull-up resistors are activated. The Port J pins are tri-stated when a reset condition becomes active, even if the clock is not running.

Port J also serves the functions of various special features of the ATmega3290PA/6490P as listed on [page 87](#).

2.3.12 $\overline{\text{RESET}}$

Reset input. A low level on this pin for longer than the minimum pulse length will generate a reset, even if the clock is not running. The minimum pulse length is given in "[System and reset characteristics](#)" on [page 332](#). Shorter pulses are not guaranteed to generate a reset.

2.3.13 XTAL1

Input to the inverting Oscillator amplifier and input to the internal clock operating circuit.

2.3.14 XTAL2

Output from the inverting Oscillator amplifier.

2.3.15 AVCC

AVCC is the supply voltage pin for Port F and the A/D Converter. It should be externally connected to V_{CC} , even if the ADC is not used. If the ADC is used, it should be connected to V_{CC} through a low-pass filter.

2.3.16 AREF

This is the analog reference pin for the A/D Converter.

2.3.17 LCDCAP

An external capacitor (typical > 470 nF) must be connected to the LCDCAP pin as shown in [Figure 24-2](#), if the LCD module is enabled and configured to use internal power. This capacitor acts as a reservoir for LCD power (V_{LCD}). A large capacitance reduces ripple on V_{LCD} but increases the time until V_{LCD} reaches its target value.

3. Resources

A comprehensive set of development tools, application notes and datasheets are available for download on <http://www.atmel.com/avr>.

4. Data retention

Reliability Qualification results show that the projected data retention failure rate is much less than 1 PPM over 20 years at 85°C or 100 years at 25°C.

5. About code examples

This documentation contains simple code examples that briefly show how to use various parts of the device. These code examples assume that the part specific header file is included before compilation. Be aware that not all C compiler vendors include bit definitions in the header files and interrupt handling in C is compiler dependent. Please confirm with the C compiler documentation for more details.

For I/O Registers located in extended I/O map, “IN”, “OUT”, “SBIS”, “SBIC”, “CBI”, and “SBI” instructions must be replaced with instructions that allow access to extended I/O. Typically “LDS” and “STS” combined with “SBR”, “SBRC”, “SBR”, and “CBR”.

6. Capacitive touch sensing

The Atmel® QTouch® Library provides a simple to use solution to realize touch sensitive interfaces on most Atmel AVR® microcontrollers. The QTouch Library includes support for the QTouch and QMatrix® acquisition methods.

Touch sensing can be added to any application by linking the appropriate Atmel QTouch Library for the AVR Microcontroller. This is done by using a simple set of APIs to define the touch channels and sensors, and then calling the touch sensing API's to retrieve the channel information and determine the touch sensor states.

The QTouch Library is FREE and downloadable from the Atmel website at the following location: www.atmel.com/qtouchlibrary. For implementation details and other information, refer to the [Atmel QTouch Library User Guide](#) - also available for download from the Atmel website.

7. Register summary

Note: Registers with bold type only available in Atmel ATmega3290A/3290PA/6490A/6490P.

Address	Name	Bit 7	Bit 6	Bit 5	Bit 4	Bit 3	Bit 2	Bit 1	Bit 0	Page
(0xFF)	LCDDR19	SEG339	SEG338	SEG337	SEG336	SEG335	SEG334	SEG333	SEG332	236
(0xFE)	LCDDR18	SEG331	SEG330	SEG329	SEG328	SEG327	SEG326	SEG325	SEG324	236
(0xFD)	LCDDR17	SEG323	SEG322	SEG321	SEG320	SEG319	SEG318	SEG317	SEG316	236
(0xFC)	LCDDR16	SEG315	SEG314	SEG313	SEG312	SEG311	SEG310	SEG309	SEG308	236
(0xFB)	LCDDR15	SEG307	SEG306	SEG305	SEG304	SEG303	SEG302	SEG301	SEG300	236
(0xFA)	LCDDR14	SEG239	SEG238	SEG237	SEG236	SEG235	SEG234	SEG233	SEG232	236
(0xF9)	LCDDR13	SEG231	SEG230	SEG229	SEG228	SEG227	SEG226	SEG225	SEG224	236
(0xF8)	LCDDR12	SEG223	SEG222	SEG221	SEG220	SEG219	SEG218	SEG217	SEG216	236
(0xF7)	LCDDR11	SEG215	SEG214	SEG213	SEG212	SEG211	SEG210	SEG209	SEG208	236
(0xF6)	LCDDR10	SEG207	SEG206	SEG205	SEG204	SEG203	SEG202	SEG201	SEG200	236
(0xF5)	LCDDR09	SEG139	SEG138	SEG137	SEG136	SEG135	SEG134	SEG133	SEG132	236

Address	Name	Bit 7	Bit 6	Bit 5	Bit 4	Bit 3	Bit 2	Bit 1	Bit 0	Page
(0xF4)	LCDDR08	SEG131	SEG130	SEG129	SEG128	SEG127	SEG126	SEG125	SEG124	236
(0xF3)	LCDDR07	SEG123	SEG122	SEG121	SEG120	SEG119	SEG118	SEG117	SEG116	236
(0xF2)	LCDDR06	SEG115	SEG114	SEG113	SEG112	SEG111	SEG110	SEG109	SEG108	236
(0xF1)	LCDDR05	SEG107	SEG106	SEG105	SEG104	SEG103	SEG102	SEG101	SEG100	236
(0xF0)	LCDDR04	SEG039	SEG038	SEG037	SEG036	SEG035	SEG034	SEG033	SEG032	236
(0xEF)	LCDDR03	SEG031	SEG030	SEG029	SEG028	SEG027	SEG026	SEG025	SEG024	236
(0xEE)	LCDDR02	SEG023	SEG022	SEG021	SEG020	SEG019	SEG018	SEG017	SEG016	236
(0xED)	LCDDR01	SEG015	SEG014	SEG013	SEG012	SEG011	SEG010	SEG009	SEG008	236
(0xEC)	LCDDR00	SEG007	SEG006	SEG005	SEG004	SEG003	SEG002	SEG001	SEG000	236
(0xEB)	Reserved	-	-	-	-	-	-	-	-	
(0xEA)	Reserved	-	-	-	-	-	-	-	-	
(0xE9)	Reserved	-	-	-	-	-	-	-	-	
(0xE8)	Reserved	-	-	-	-	-	-	-	-	
(0xE7)	LCDDCR	LCDDC2	LCDDC1	LCDDC0	LCDMDT	LCDCC3	LCDDC2	LCDDC1	LCDDC0	234
(0xE6)	LCDFRR	-	LCDPS2	LCDPS1	LCDPS0	-	LCDCD2	LCDCD1	LCDCD0	233
(0xE5)	LCDCRB	LCDCS	LCD2B	LCDMUX1	LCDMUX0	LCDDPM3	LCDDPM2	LCDDPM1	LCDDPM0	232
(0xE4)	LCDCRA	LCDEN	LCDAB	-	LCDIF	LCDIE	LCDBD	LCDDCD	LCDBL	231
(0xE3)	Reserved	-	-	-	-	-	-	-	-	
(0xE2)	Reserved	-	-	-	-	-	-	-	-	
(0xE1)	Reserved	-	-	-	-	-	-	-	-	
(0xE0)	Reserved	-	-	-	-	-	-	-	-	
(0xDF)	Reserved	-	-	-	-	-	-	-	-	
(0xDE)	Reserved	-	-	-	-	-	-	-	-	
(0xDD)	PORTJ	-	PORTJ6	PORTJ5	PORTJ4	PORTJ3	PORTJ2	PORTJ1	PORTJ0	93
(0xDC)	DDRJ	-	DDJ6	DDJ5	DDJ4	DDJ3	DDJ2	DDJ1	DDJ0	93
(0xDB)	PINJ	-	PINJ6	PINJ5	PINJ4	PINJ3	PINJ2	PINJ1	PINJ0	93
(0xDA)	PORTR	PORTR7	PORTR6	PORTR5	PORTR4	PORTR3	PORTR2	PORTR1	PORTR0	93
(0xD9)	DDRH	DDH7	DDH6	DDH5	DDH4	DDH3	DDH2	DDH1	DDH0	93
(0xD8)	PINH	PINH7	PINH6	PINH5	PINH4	PINH3	PINH2	PINH1	PINH0	93
(0xD7)	Reserved	-	-	-	-	-	-	-	-	
(0xD6)	Reserved	-	-	-	-	-	-	-	-	
(0xD5)	Reserved	-	-	-	-	-	-	-	-	
(0xD4)	Reserved	-	-	-	-	-	-	-	-	
(0xD3)	Reserved	-	-	-	-	-	-	-	-	
(0xD2)	Reserved	-	-	-	-	-	-	-	-	
(0xD1)	Reserved	-	-	-	-	-	-	-	-	
(0xD0)	Reserved	-	-	-	-	-	-	-	-	
(0xCF)	Reserved	-	-	-	-	-	-	-	-	
(0xCE)	Reserved	-	-	-	-	-	-	-	-	
(0xCD)	Reserved	-	-	-	-	-	-	-	-	
(0xCC)	Reserved	-	-	-	-	-	-	-	-	
(0xCB)	Reserved	-	-	-	-	-	-	-	-	
(0xCA)	Reserved	-	-	-	-	-	-	-	-	
(0xC9)	Reserved	-	-	-	-	-	-	-	-	
(0xC8)	Reserved	-	-	-	-	-	-	-	-	
(0xC7)	Reserved	-	-	-	-	-	-	-	-	
(0xC6)	UDR0	USART0 Data Register								186
(0xC5)	UBRR0H					USART0 Baud Rate Register High				190
(0xC4)	UBRR0L	USART0 Baud Rate Register Low								190
(0xC3)	Reserved	-	-	-	-	-	-	-	-	
(0xC2)	UCSR0C	-	UMSEL0	UPM01	UPM00	USBS0	UCSZ01	UCSZ00	UCPOL0	189
(0xC1)	UCSR0B	RXCIE0	TXCIE0	UDRIE0	RXEN0	TXEN0	UCSZ02	RXB80	TXB80	188
(0xC0)	UCSR0A	RXC0	TXC0	UDRE0	FE0	DOR0	UPE0	U2X0	MPCM0	187
(0xBF)	Reserved	-	-	-	-	-	-	-	-	
(0xBE)	Reserved	-	-	-	-	-	-	-	-	
(0xBD)	Reserved	-	-	-	-	-	-	-	-	
(0xBC)	Reserved	-	-	-	-	-	-	-	-	
(0xBB)	Reserved	-	-	-	-	-	-	-	-	
(0xBA)	USIDR	USI Data Register								197
(0xB9)	USISR	USISIF	USIOIF	USIPF	USIDC	USICNT3	USICNT2	USICNT1	USICNT0	198
(0xB8)	USICR	USISIE	USIOIE	USIWM1	USIWM0	USICS1	USICS0	USICLK	USITC	198
(0xB7)	Reserved	-	-	-	-	-	-	-	-	
(0xB6)	ASSR	-	-	-	EXCLK	AS2	TCN2UB	OCR2UB	TCR2UB	153
(0xB5)	Reserved	-	-	-	-	-	-	-	-	
(0xB4)	Reserved	-	-	-	-	-	-	-	-	

Address	Name	Bit 7	Bit 6	Bit 5	Bit 4	Bit 3	Bit 2	Bit 1	Bit 0	Page
(0xB3)	OCR2A	Timer/Counter 2 Output Compare Register A								153
(0xB2)	TCNT2	Timer/Counter2								153
(0xB1)	Reserved	-	-	-	-	-	-	-	-	
(0xB0)	TCCR2A	FOC2A	WGM20	COM2A1	COM2A0	WGM21	CS22	CS21	CS20	151
(0xAF)	Reserved	-	-	-	-	-	-	-	-	
(0xAE)	Reserved	-	-	-	-	-	-	-	-	
(0xAD)	Reserved	-	-	-	-	-	-	-	-	
(0xAC)	Reserved	-	-	-	-	-	-	-	-	
(0xAB)	Reserved	-	-	-	-	-	-	-	-	
(0xAA)	Reserved	-	-	-	-	-	-	-	-	
(0xA9)	Reserved	-	-	-	-	-	-	-	-	
(0xA8)	Reserved	-	-	-	-	-	-	-	-	
(0xA7)	Reserved	-	-	-	-	-	-	-	-	
(0xA6)	Reserved	-	-	-	-	-	-	-	-	
(0xA5)	Reserved	-	-	-	-	-	-	-	-	
(0xA4)	Reserved	-	-	-	-	-	-	-	-	
(0xA3)	Reserved	-	-	-	-	-	-	-	-	
(0xA2)	Reserved	-	-	-	-	-	-	-	-	
(0xA1)	Reserved	-	-	-	-	-	-	-	-	
(0xA0)	Reserved	-	-	-	-	-	-	-	-	
(0x9F)	Reserved	-	-	-	-	-	-	-	-	
(0x9E)	Reserved	-	-	-	-	-	-	-	-	
(0x9D)	Reserved	-	-	-	-	-	-	-	-	
(0x9C)	Reserved	-	-	-	-	-	-	-	-	
(0x9B)	Reserved	-	-	-	-	-	-	-	-	
(0x9A)	Reserved	-	-	-	-	-	-	-	-	
(0x99)	Reserved	-	-	-	-	-	-	-	-	
(0x98)	Reserved	-	-	-	-	-	-	-	-	
(0x97)	Reserved	-	-	-	-	-	-	-	-	
(0x96)	Reserved	-	-	-	-	-	-	-	-	
(0x95)	Reserved	-	-	-	-	-	-	-	-	
(0x94)	Reserved	-	-	-	-	-	-	-	-	
(0x93)	Reserved	-	-	-	-	-	-	-	-	
(0x92)	Reserved	-	-	-	-	-	-	-	-	
(0x91)	Reserved	-	-	-	-	-	-	-	-	
(0x90)	Reserved	-	-	-	-	-	-	-	-	
(0x8F)	Reserved	-	-	-	-	-	-	-	-	
(0x8E)	Reserved	-	-	-	-	-	-	-	-	
(0x8D)	Reserved	-	-	-	-	-	-	-	-	
(0x8C)	Reserved	-	-	-	-	-	-	-	-	
(0x8B)	OCR1BH	Timer/Counter1 Output Compare Register B High								130
(0x8A)	OCR1BL	Timer/Counter1 Output Compare Register B Low								130
(0x89)	OCR1AH	Timer/Counter1 Output Compare Register A High								130
(0x88)	OCR1AL	Timer/Counter1 Output Compare Register A Low								130
(0x87)	ICR1H	Timer/Counter1 Input Capture Register High								131
(0x86)	ICR1L	Timer/Counter1 Input Capture Register Low								131
(0x85)	TCNT1H	Timer/Counter1 High								130
(0x84)	TCNT1L	Timer/Counter1 Low								130
(0x83)	Reserved	-	-	-	-	-	-	-	-	
(0x82)	TCCR1C	FOC1A	FOC1B	-	-	-	-	-	-	129
(0x81)	TCCR1B	ICNC1	ICES1	-	WGM13	WGM12	CS12	CS11	CS10	128
(0x80)	TCCR1A	COM1A1	COM1A0	COM1B1	COM1B0	-	-	WGM11	WGM10	126
(0x7F)	DIDR1	-	-	-	-	-	-	AIN1D	AIN0D	203
(0x7E)	DIDR0	ADC7D	ADC6D	ADC5D	ADC4D	ADC3D	ADC2D	ADC1D	ADC0D	220
(0x7D)	Reserved	-	-	-	-	-	-	-	-	
(0x7C)	ADMUX	REFS1	REFS0	ADLAR	MUX4	MUX3	MUX2	MUX1	MUX0	216
(0x7B)	ADCSRB	-	ACME	-	-	-	ADTS2	ADTS1	ADTS0	202/219
(0x7A)	ADCSRA	ADEN	ADSC	ADATE	ADIF	ADIE	ADPS2	ADPS1	ADPS0	218
(0x79)	ADCH	ADC Data Register High								219
(0x78)	ADCL	ADC Data Register Low								219
(0x77)	Reserved	-	-	-	-	-	-	-	-	
(0x76)	Reserved	-	-	-	-	-	-	-	-	
(0x75)	Reserved	-	-	-	-	-	-	-	-	
(0x74)	Reserved	-	-	-	-	-	-	-	-	
(0x73)	PCMSK3	-	PCINT30	PCINT29	PCINT28	PCINT27	PCINT26	PCINT25	PCINT24	64

Address	Name	Bit 7	Bit 6	Bit 5	Bit 4	Bit 3	Bit 2	Bit 1	Bit 0	Page
(0x72)	Reserved	-	-	-	-	-	-	-	-	
(0x71)	Reserved	-	-	-	-	-	-	-	-	
(0x70)	TIMSK2	-	-	-	-	-	-	OCIE2A	TOIE2	154
(0x6F)	TIMSK1	-	-	ICIE1	-	-	OCIE1B	OCIE1A	TOIE1	131
(0x6E)	TIMSK0	-	-	-	-	-	-	OCIE0A	TOIE0	137
(0x6D)	PCMSK2	PCINT23	PCINT22	PCINT21	PCINT20	PCINT19	PCINT18	PCINT17	PCINT16	64
(0x6C)	PCMSK1	PCINT15	PCINT14	PCINT13	PCINT12	PCINT11	PCINT10	PCINT9	PCINT8	64
(0x6B)	PCMSK0	PCINT7	PCINT6	PCINT5	PCINT4	PCINT3	PCINT2	PCINT1	PCINT0	64
(0x6A)	Reserved	-	-	-	-	-	-	-	-	
(0x69)	EICRA	-	-	-	-	-	-	ISC01	ISC00	61
(0x68)	Reserved	-	-	-	-	-	-	-	-	
(0x67)	Reserved	-	-	-	-	-	-	-	-	
(0x66)	OSCCAL	Oscillator Calibration Register [CAL7...0]								38
(0x65)	Reserved	-	-	-	-	-	-	-	-	
(0x64)	PRR	-	-	-	PRLCD	PRTIM1	PRSPI	PSUSART0	PRADC	46
(0x63)	Reserved	-	-	-	-	-	-	-	-	
(0x62)	Reserved	-	-	-	-	-	-	-	-	
(0x61)	CLKPR	CLKPCE	-	-	-	CLKPS3	CLKPS2	CLKPS1	CLKPS0	38
(0x60)	WDTCR	-	-	-	WDCE	WDE	WDP2	WDP1	WDP0	53
0x3F (0x5F)	SREG	I	T	H	S	V	N	Z	C	15
0x3E (0x5E)	SPH	Stack Pointer High								17
0x3D (0x5D)	SPL	Stack Pointer Low								17
0x3C (0x5C)	Reserved	-	-	-	-	-	-	-	-	
0x3B (0x5B)	Reserved	-	-	-	-	-	-	-	-	
0x3A (0x5A)	Reserved	-	-	-	-	-	-	-	-	
0x39 (0x59)	Reserved	-	-	-	-	-	-	-	-	
0x38 (0x58)	Reserved	-	-	-	-	-	-	-	-	
0x37 (0x57)	SPMCSR	SPMIE	RWWSB	-	RWWSRE	BLBSET	PGWRT	PGERS	SPMEN	289
0x36 (0x56)	Reserved	-	-	-	-	-	-	-	-	
0x35 (0x55)	MCUCR	JTD	BODS	BODSE	PUD	-	-	IVSEL	IVCE	59/90/275
0x34 (0x54)	MCUSR	-	-	-	JTRF	WDRF	BORF	EXTRF	PORF	53
0x33 (0x53)	SMCR	-	-	-	-	SM2	SM1	SM0	SE	45
0x32 (0x52)	Reserved	-	-	-	-	-	-	-	-	
0x31 (0x51)	OCDR	IDRD/OCDR7	OCDR6	OCDR5	OCDR4	OCDR3	OCDR2	OCDR1	OCDR0	242
0x30 (0x50)	ACSR	ACD	ACBG	ACO	ACI	ACIE	ACIC	ACIS1	ACIS0	202
0x2F (0x4F)	Reserved	-	-	-	-	-	-	-	-	
0x2E (0x4E)	SPDR	SPI Data Register								165
0x2D (0x4D)	SPSR	SPIF	WCOL	-	-	-	-	-	SPI2X	164
0x2C (0x4C)	SPCR	SPIE	SPE	DORD	MSTR	CPOL	CPHA	SPR1	SPR0	163
0x2B (0x4B)	GPIOR2	General Purpose I/O Register								29
0x2A (0x4A)	GPIOR1	General Purpose I/O Register								29
0x29 (0x49)	Reserved	-	-	-	-	-	-	-	-	
0x28 (0x48)	Reserved	-	-	-	-	-	-	-	-	
0x27 (0x47)	OCR0A	Timer/Counter0 Output Compare A								138
0x26 (0x46)	TCNT0	Timer/Counter0								137
0x25 (0x45)	Reserved	-	-	-	-	-	-	-	-	
0x24 (0x44)	TCCR0A	FOC0A	WGM00	COM0A1	COM0A0	WGM01	CS02	CS01	CS00	135
0x23 (0x43)	GTCCR	TSM	-	-	-	-	-	PSR2	PSR10	138/155
0x22 (0x42)	EEARH	-	-	-	-	-	EEPROM Address Register High			28
0x21 (0x41)	EEARL	EEPROM Address Register Low								28
0x20 (0x40)	EEDR	EEPROM Data Register								28
0x1F (0x3F)	EEDCR	-	-	-	-	EERIE	EEMWE	EEWE	EERE	28
0x1E (0x3E)	GPIOR0	General Purpose I/O Register								29
0x1D (0x3D)	EIMSK	PCIE	PCIE2	PCIE1	PCIE0	-	-	-	INT0	62
0x1C (0x3C)	EIFR	PCIF3	PCIF2	PCIF1	PCIF0	-	-	-	INTF0	63
0x1B (0x3B)	Reserved	-	-	-	-	-	-	-	-	
0x1A (0x3A)	Reserved	-	-	-	-	-	-	-	-	
0x19 (0x39)	Reserved	-	-	-	-	-	-	-	-	
0x18 (0x38)	Reserved	-	-	-	-	-	-	-	-	
0x17 (0x37)	TIFR2	-	-	-	-	-	-	OCF2A	TOV2	154
0x16 (0x36)	TIFR1	-	-	ICF1	-	-	OCF1B	OCF1A	TOV1	131
0x15 (0x35)	TIFR0	-	-	-	-	-	-	OCF0A	TOV0	138
0x14 (0x34)	PORTG	-	-	-	PORTG4	PORTG3	PORTG2	PORTG1	PORTG0	92
0x13 (0x33)	DDRG	-	-	-	DDG4	DDG3	DDG2	DDG1	DDG0	92
0x12 (0x32)	PING	-	-	PING5	PING4	PING3	PING2	PING1	PING0	92

Address	Name	Bit 7	Bit 6	Bit 5	Bit 4	Bit 3	Bit 2	Bit 1	Bit 0	Page
0x11 (0x31)	PORTF	PORTF7	PORTF6	PORTF5	PORTF4	PORTF3	PORTF2	PORTF1	PORTF0	92
0x10 (0x30)	DDRF	DDF7	DDF6	DDF5	DDF4	DDF3	DDF2	DDF1	DDF0	92
0x0F (0x2F)	PINF	PINF7	PINF6	PINF5	PINF4	PINF3	PINF2	PINF1	PINF0	92
0x0E (0x2E)	PORTE	PORTE7	PORTE6	PORTE5	PORTE4	PORTE3	PORTE2	PORTE1	PORTE0	91
0x0D (0x2D)	DDRE	DDE7	DDE6	DDE5	DDE4	DDE3	DDE2	DDE1	DDE0	92
0x0C (0x2C)	PINE	PINE7	PINE6	PINE5	PINE4	PINE3	PINE2	PINE1	PINE0	92
0x0B (0x2B)	PORTD	PORTD7	PORTD6	PORTD5	PORTD4	PORTD3	PORTD2	PORTD1	PORTD0	91
0x0A (0x2A)	DDRD	DDD7	DDD6	DDD5	DDD4	DDD3	DDD2	DDD1	DDD0	91
0x09 (0x29)	PIND	PIND7	PIND6	PIND5	PIND4	PIND3	PIND2	PIND1	PIND0	91
0x08 (0x28)	PORTC	PORTC7	PORTC6	PORTC5	PORTC4	PORTC3	PORTC2	PORTC1	PORTC0	91
0x07 (0x27)	DDRC	DDC7	DDC6	DDC5	DDC4	DDC3	DDC2	DDC1	DDC0	91
0x06 (0x26)	PINC	PINC7	PINC6	PINC5	PINC4	PINC3	PINC2	PINC1	PINC0	91
0x05 (0x25)	PORTB	PORTB7	PORTB6	PORTB5	PORTB4	PORTB3	PORTB2	PORTB1	PORTB0	90
0x04 (0x24)	DDRB	DDB7	DDB6	DDB5	DDB4	DDB3	DDB2	DDB1	DDB0	90
0x03 (0x23)	PINB	PINB7	PINB6	PINB5	PINB4	PINB3	PINB2	PINB1	PINB0	91
0x02 (0x22)	PORTA	PORTA7	PORTA6	PORTA5	PORTA4	PORTA3	PORTA2	PORTA1	PORTA0	90
0x01 (0x21)	DDRA	DDA7	DDA6	DDA5	DDA4	DDA3	DDA2	DDA1	DDA0	90
0x00 (0x20)	PINA	PINA7	PINA6	PINA5	PINA4	PINA3	PINA2	PINA1	PINA0	90

- Notes:
1. For compatibility with future devices, reserved bits should be written to zero if accessed. Reserved I/O memory addresses should never be written.
 2. I/O Registers within the address range 0x00 - 0x1F are directly bit-accessible using the SBI and CBI instructions. In these registers, the value of single bits can be checked by using the SBIS and SBIC instructions.
 3. Some of the Status Flags are cleared by writing a logical one to them. Note that, unlike most other AVRs, the CBI and SBI instructions will only operate on the specified bit, and can therefore be used on registers containing such Status Flags. The CBI and SBI instructions work with registers 0x00 to 0x1F only.
 4. When using the I/O specific commands IN and OUT, the I/O addresses 0x00 - 0x3F must be used. When addressing I/O Registers as data space using LD and ST instructions, 0x20 must be added to these addresses. The Atmel ATmega169A/169PA/329A/329PA/3290A/3290PA/649A/649P/6490A/6490P is a complex microcontroller with more peripheral units than can be supported within the 64 location reserved in Opcode for the IN and OUT instructions. For the Extended I/O space from 0x60 - 0xFF in SRAM, only the ST/STS/STD and LD/LDS/LDD instructions can be used.

8. Instruction set summary

Mnemonics	Operands	Description	Operation	Flags	#Clocks
ARITHMETIC AND LOGIC INSTRUCTIONS					
ADD	Rd, Rr	Add two Registers	$Rd \leftarrow Rd + Rr$	Z,C,N,V,H	1
ADC	Rd, Rr	Add with Carry two Registers	$Rd \leftarrow Rd + Rr + C$	Z,C,N,V,H	1
ADIW	RdI,K	Add Immediate to Word	$Rdh:Rdl \leftarrow Rdh:Rdl + K$	Z,C,N,V,S	2
SUB	Rd, Rr	Subtract two Registers	$Rd \leftarrow Rd - Rr$	Z,C,N,V,H	1
SUBI	Rd, K	Subtract Constant from Register	$Rd \leftarrow Rd - K$	Z,C,N,V,H	1
SBC	Rd, Rr	Subtract with Carry two Registers	$Rd \leftarrow Rd - Rr - C$	Z,C,N,V,H	1
SBCI	Rd, K	Subtract with Carry Constant from Reg.	$Rd \leftarrow Rd - K - C$	Z,C,N,V,H	1
SBIW	RdI,K	Subtract Immediate from Word	$Rdh:Rdl \leftarrow Rdh:Rdl - K$	Z,C,N,V,S	2
AND	Rd, Rr	Logical AND Registers	$Rd \leftarrow Rd \bullet Rr$	Z,N,V	1
ANDI	Rd, K	Logical AND Register and Constant	$Rd \leftarrow Rd \bullet K$	Z,N,V	1
OR	Rd, Rr	Logical OR Registers	$Rd \leftarrow Rd \vee Rr$	Z,N,V	1
ORI	Rd, K	Logical OR Register and Constant	$Rd \leftarrow Rd \vee K$	Z,N,V	1
EOR	Rd, Rr	Exclusive OR Registers	$Rd \leftarrow Rd \oplus Rr$	Z,N,V	1
COM	Rd	One's Complement	$Rd \leftarrow 0xFF - Rd$	Z,C,N,V	1
NEG	Rd	Two's Complement	$Rd \leftarrow 0x00 - Rd$	Z,C,N,V,H	1
SBR	Rd,K	Set Bit(s) in Register	$Rd \leftarrow Rd \vee K$	Z,N,V	1
CBR	Rd,K	Clear Bit(s) in Register	$Rd \leftarrow Rd \bullet (0xFF - K)$	Z,N,V	1
INC	Rd	Increment	$Rd \leftarrow Rd + 1$	Z,N,V	1
DEC	Rd	Decrement	$Rd \leftarrow Rd - 1$	Z,N,V	1
TST	Rd	Test for Zero or Minus	$Rd \leftarrow Rd \bullet Rd$	Z,N,V	1
CLR	Rd	Clear Register	$Rd \leftarrow Rd \oplus Rd$	Z,N,V	1
SER	Rd	Set Register	$Rd \leftarrow 0xFF$	None	1
MUL	Rd, Rr	Multiply Unsigned	$R1:R0 \leftarrow Rd \times Rr$	Z,C	2
MULS	Rd, Rr	Multiply Signed	$R1:R0 \leftarrow Rd \times Rr$	Z,C	2
MULSU	Rd, Rr	Multiply Signed with Unsigned	$R1:R0 \leftarrow Rd \times Rr$	Z,C	2
FMUL	Rd, Rr	Fractional Multiply Unsigned	$R1:R0 \leftarrow (Rd \times Rr) \lll 1$	Z,C	2
FMULS	Rd, Rr	Fractional Multiply Signed	$R1:R0 \leftarrow (Rd \times Rr) \lll 1$	Z,C	2
FMULSU	Rd, Rr	Fractional Multiply Signed with Unsigned	$R1:R0 \leftarrow (Rd \times Rr) \lll 1$	Z,C	2
BRANCH INSTRUCTIONS					
RJMP	k	Relative Jump	$PC \leftarrow PC + k + 1$	None	2
IJMP		Indirect Jump to (Z)	$PC \leftarrow Z$	None	2
JMP	k	Direct Jump	$PC \leftarrow k$	None	3
RCALL	k	Relative Subroutine Call	$PC \leftarrow PC + k + 1$	None	3
ICALL		Indirect Call to (Z)	$PC \leftarrow Z$	None	3
CALL	k	Direct Subroutine Call	$PC \leftarrow k$	None	4
RET		Subroutine Return	$PC \leftarrow STACK$	None	4
RETI		Interrupt Return	$PC \leftarrow STACK$	I	4
CPSE	Rd,Rr	Compare, Skip if Equal	if $(Rd = Rr) PC \leftarrow PC + 2$ or 3	None	1/2/3
CP	Rd,Rr	Compare	$Rd - Rr$	Z, N, V, C, H	1
CPC	Rd,Rr	Compare with Carry	$Rd - Rr - C$	Z, N, V, C, H	1
CPI	Rd,K	Compare Register with Immediate	$Rd - K$	Z, N, V, C, H	1
SBRC	Rr, b	Skip if Bit in Register Cleared	if $(Rr(b)=0) PC \leftarrow PC + 2$ or 3	None	1/2/3
SBRS	Rr, b	Skip if Bit in Register is Set	if $(Rr(b)=1) PC \leftarrow PC + 2$ or 3	None	1/2/3
SBIC	P, b	Skip if Bit in I/O Register Cleared	if $(P(b)=0) PC \leftarrow PC + 2$ or 3	None	1/2/3
SBIS	P, b	Skip if Bit in I/O Register is Set	if $(P(b)=1) PC \leftarrow PC + 2$ or 3	None	1/2/3
BRBS	s, k	Branch if Status Flag Set	if $(SREG(s) = 1) PC \leftarrow PC + k + 1$	None	1/2
BRBC	s, k	Branch if Status Flag Cleared	if $(SREG(s) = 0) PC \leftarrow PC + k + 1$	None	1/2
BREQ	k	Branch if Equal	if $(Z = 1) PC \leftarrow PC + k + 1$	None	1/2
BRNE	k	Branch if Not Equal	if $(Z = 0) PC \leftarrow PC + k + 1$	None	1/2
BRCS	k	Branch if Carry Set	if $(C = 1) PC \leftarrow PC + k + 1$	None	1/2
BRCC	k	Branch if Carry Cleared	if $(C = 0) PC \leftarrow PC + k + 1$	None	1/2
BRSH	k	Branch if Same or Higher	if $(C = 0) PC \leftarrow PC + k + 1$	None	1/2
BRLO	k	Branch if Lower	if $(C = 1) PC \leftarrow PC + k + 1$	None	1/2
BRMI	k	Branch if Minus	if $(N = 1) PC \leftarrow PC + k + 1$	None	1/2
BRPL	k	Branch if Plus	if $(N = 0) PC \leftarrow PC + k + 1$	None	1/2
BRGE	k	Branch if Greater or Equal, Signed	if $(N \oplus V = 0) PC \leftarrow PC + k + 1$	None	1/2
BRLT	k	Branch if Less Than Zero, Signed	if $(N \oplus V = 1) PC \leftarrow PC + k + 1$	None	1/2
BRHS	k	Branch if Half Carry Flag Set	if $(H = 1) PC \leftarrow PC + k + 1$	None	1/2
BRHC	k	Branch if Half Carry Flag Cleared	if $(H = 0) PC \leftarrow PC + k + 1$	None	1/2
BRTS	k	Branch if T Flag Set	if $(T = 1) PC \leftarrow PC + k + 1$	None	1/2
BRTC	k	Branch if T Flag Cleared	if $(T = 0) PC \leftarrow PC + k + 1$	None	1/2
BRVS	k	Branch if Overflow Flag is Set	if $(V = 1) PC \leftarrow PC + k + 1$	None	1/2

Mnemonics	Operands	Description	Operation	Flags	#Clocks
BRVC	k	Branch if Overflow Flag is Cleared	if (V = 0) then PC ← PC + k + 1	None	1/2
BRIE	k	Branch if Interrupt Enabled	if (I = 1) then PC ← PC + k + 1	None	1/2
BRID	k	Branch if Interrupt Disabled	if (I = 0) then PC ← PC + k + 1	None	1/2
BIT AND BIT-TEST INSTRUCTIONS					
SBI	P,b	Set Bit in I/O Register	I/O(P,b) ← 1	None	2
CBI	P,b	Clear Bit in I/O Register	I/O(P,b) ← 0	None	2
LSL	Rd	Logical Shift Left	Rd(n+1) ← Rd(n), Rd(0) ← 0	Z,C,N,V	1
LSR	Rd	Logical Shift Right	Rd(n) ← Rd(n+1), Rd(7) ← 0	Z,C,N,V	1
ROL	Rd	Rotate Left Through Carry	Rd(0) ← C, Rd(n+1) ← Rd(n), C ← Rd(7)	Z,C,N,V	1
ROR	Rd	Rotate Right Through Carry	Rd(7) ← C, Rd(n) ← Rd(n+1), C ← Rd(0)	Z,C,N,V	1
ASR	Rd	Arithmetic Shift Right	Rd(n) ← Rd(n+1), n=0..6	Z,C,N,V	1
SWAP	Rd	Swap Nibbles	Rd(3..0) ← Rd(7..4), Rd(7..4) ← Rd(3..0)	None	1
BSET	s	Flag Set	SREG(s) ← 1	SREG(s)	1
BCLR	s	Flag Clear	SREG(s) ← 0	SREG(s)	1
BST	Rr, b	Bit Store from Register to T	T ← Rr(b)	T	1
BLD	Rd, b	Bit load from T to Register	Rd(b) ← T	None	1
SEC		Set Carry	C ← 1	C	1
CLC		Clear Carry	C ← 0	C	1
SEN		Set Negative Flag	N ← 1	N	1
CLN		Clear Negative Flag	N ← 0	N	1
SEZ		Set Zero Flag	Z ← 1	Z	1
CLZ		Clear Zero Flag	Z ← 0	Z	1
SEI		Global Interrupt Enable	I ← 1	I	1
CLI		Global Interrupt Disable	I ← 0	I	1
SES		Set Signed Test Flag	S ← 1	S	1
CLS		Clear Signed Test Flag	S ← 0	S	1
SEV		Set Twos Complement Overflow.	V ← 1	V	1
CLV		Clear Twos Complement Overflow	V ← 0	V	1
SET		Set T in SREG	T ← 1	T	1
CLT		Clear T in SREG	T ← 0	T	1
SEH		Set Half Carry Flag in SREG	H ← 1	H	1
CLH		Clear Half Carry Flag in SREG	H ← 0	H	1
DATA TRANSFER INSTRUCTIONS					
MOV	Rd, Rr	Move Between Registers	Rd ← Rr	None	1
MOVW	Rd, Rr	Copy Register Word	Rd+1:Rd ← Rr+1:Rr	None	1
LDI	Rd, K	Load Immediate	Rd ← K	None	1
LD	Rd, X	Load Indirect	Rd ← (X)	None	2
LD	Rd, X+	Load Indirect and Post-Inc.	Rd ← (X), X ← X + 1	None	2
LD	Rd, -X	Load Indirect and Pre-Dec.	X ← X - 1, Rd ← (X)	None	2
LD	Rd, Y	Load Indirect	Rd ← (Y)	None	2
LD	Rd, Y+	Load Indirect and Post-Inc.	Rd ← (Y), Y ← Y + 1	None	2
LD	Rd, -Y	Load Indirect and Pre-Dec.	Y ← Y - 1, Rd ← (Y)	None	2
LDD	Rd, Y+q	Load Indirect with Displacement	Rd ← (Y + q)	None	2
LD	Rd, Z	Load Indirect	Rd ← (Z)	None	2
LD	Rd, Z+	Load Indirect and Post-Inc.	Rd ← (Z), Z ← Z+1	None	2
LD	Rd, -Z	Load Indirect and Pre-Dec.	Z ← Z - 1, Rd ← (Z)	None	2
LDD	Rd, Z+q	Load Indirect with Displacement	Rd ← (Z + q)	None	2
LDS	Rd, k	Load Direct from SRAM	Rd ← (k)	None	2
ST	X, Rr	Store Indirect	(X) ← Rr	None	2
ST	X+, Rr	Store Indirect and Post-Inc.	(X) ← Rr, X ← X + 1	None	2
ST	-X, Rr	Store Indirect and Pre-Dec.	X ← X - 1, (X) ← Rr	None	2
ST	Y, Rr	Store Indirect	(Y) ← Rr	None	2
ST	Y+, Rr	Store Indirect and Post-Inc.	(Y) ← Rr, Y ← Y + 1	None	2
ST	-Y, Rr	Store Indirect and Pre-Dec.	Y ← Y - 1, (Y) ← Rr	None	2
STD	Y+q, Rr	Store Indirect with Displacement	(Y + q) ← Rr	None	2
ST	Z, Rr	Store Indirect	(Z) ← Rr	None	2
ST	Z+, Rr	Store Indirect and Post-Inc.	(Z) ← Rr, Z ← Z + 1	None	2
ST	-Z, Rr	Store Indirect and Pre-Dec.	Z ← Z - 1, (Z) ← Rr	None	2
STD	Z+q, Rr	Store Indirect with Displacement	(Z + q) ← Rr	None	2
STS	k, Rr	Store Direct to SRAM	(k) ← Rr	None	2
LPM		Load Program Memory	R0 ← (Z)	None	3
LPM	Rd, Z	Load Program Memory	Rd ← (Z)	None	3
LPM	Rd, Z+	Load Program Memory and Post-Inc.	Rd ← (Z), Z ← Z+1	None	3
SPM		Store Program Memory	(Z) ← R1:R0	None	-
IN	Rd, P	In Port	Rd ← P	None	1
OUT	P, Rr	Out Port	P ← Rr	None	1
PUSH	Rr	Push Register on Stack	STACK ← Rr	None	2
POP	Rd	Pop Register from Stack	Rd ← STACK	None	2

Mnemonics	Operands	Description	Operation	Flags	#Clocks
MCU CONTROL INSTRUCTIONS					
NOP		No Operation		None	1
SLEEP		Sleep	(see specific descr. for Sleep function)	None	1
WDR		Watchdog Reset	(see specific descr. for WDR/timer)	None	1
BREAK		Break	For On-chip Debug Only	None	N/A

9. Ordering information

9.1 Atmel ATmega169A

Speed [MHz] ⁽³⁾	Power supply	Ordering code ⁽²⁾	Package type ⁽¹⁾	Operational range
16	1.8 - 5.5V	ATmega169A-AU	64A	Industrial (-40°C to 85°C)
		ATmega169A-AUR ⁽⁴⁾	64A	
ATmega169A-MU	64M1			
ATmega169A-MUR ⁽⁴⁾	64M1			
ATmega169A-MCH	64MC			
ATmega169A-MCHR ⁽⁴⁾	64MC			
		ATmega169A-AN	64A	Extended (-40°C to 105°C)
		ATmega169A-ANR ⁽⁴⁾	64A	
		ATmega169A-MN	64M1	
		ATmega169A-MNR ⁽⁴⁾	64M1	

- Notes:
1. This device can also be supplied in wafer form. Please contact your local Atmel sales office for detailed ordering information and minimum quantities.
 2. Pb-free packaging, complies to the European Directive for Restriction of Hazardous Substances (RoHS directive). Also Halide free and fully Green.
 3. For Speed vs. V_{CC} , see [Figure 29-1 on page 330](#).
 4. Tape & Reel.

Package type	
	64-lead, thin (1.0mm) plastic Gull Wing Quad Flat Package (TQFP)
	64-pad, 9 × 9 × 1.0mm body, lead pitch 0.50mm, Quad Flat No-Lead/Micro Lead Frame Package (QFN/MLF)
	64-lead (2-row Staggered), 7 × 7 × 1.0mm body, 4.0 × 4.0 mm Exposed Pad, Quad Flat No-Lead Package (QFN)

9.2 Atmel ATmega169PA

Speed [MHz] ⁽³⁾	Power supply	Ordering code ⁽²⁾	Package type ⁽¹⁾	Operational range
16	1.8 - 5.5V	ATmega169PA-AU	64A	Industrial (-40°C to 85°C)
		ATmega169PA-AUR ⁽⁴⁾	64A	
		ATmega169PA-MU	64M1	
		ATmega169PA-MUR ⁽⁴⁾	64M1	
		ATmega169PA-MCH	64MC	
		ATmega169PA-MCHR ⁽⁴⁾	64MC	
		ATmega169PA-AN	64A	Extended (-40°C to 105°C) ⁽⁵⁾
		ATmega169PA-ANR ⁽⁴⁾	64A	
		ATmega169PA-MN	64M1	
		ATmega169PA-MNR ⁽⁴⁾	64M1	

- Notes:
1. This device can also be supplied in wafer form. Please contact your local Atmel sales office for detailed ordering information and minimum quantities.
 2. Pb-free packaging, complies to the European Directive for Restriction of Hazardous Substances (RoHS directive). Also Halide free and fully Green.
 3. For Speed vs. V_{CC} , see [Figure 29-1 on page 330](#).
 4. Tape & Reel.
 5. See characterization specification at 105°C.

Package type	
	64-lead, thin (1.0mm) plastic Gull Wing Quad Flat Package (TQFP)
	64-pad, 9 × 9 × 1.0mm body, lead pitch 0.50mm, Quad Flat No-Lead/Micro Lead Frame Package (QFN/MLF)
	64-lead (2-row Staggered), 7 × 7 × 1.0mm body, 4.0 × 4.0mm Exposed Pad, Quad Flat No-Lead Package (QFN)

9.3 Atmel ATmega329A

Speed [MHz] ⁽³⁾	Power supply	Ordering code ⁽²⁾	Package type ⁽¹⁾	Operational range
20	1.8 - 5.5V	ATmega329A-AU ATmega329A-AUR ⁽⁴⁾ ATmega329A-MU ATmega329A-MUR ⁽⁴⁾	64A 64A 64M1 64M1	Industrial (-40°C to 85°C)
		ATmega329A-AN ATmega329A-ANR ⁽⁴⁾ ATmega329A-MN ATmega329A-MNR ⁽⁴⁾	64A 64A 64M1 64M1	Extended (-40°C to 105°C) ⁽⁵⁾

- Notes:
1. This device can also be supplied in wafer form. Please contact your local Atmel sales office for detailed ordering information and minimum quantities.
 2. Pb-free packaging complies to the European Directive for Restriction of Hazardous Substances (RoHS directive). Also Halide free and fully Green.
 3. For Speed vs. V_{CC} see [Figure 29-2 on page 330](#).
 4. Tape & Reel.
 5. See characterization specifications at 105°C.

Package type	
	64-lead, 14 × 14 × 1.0mm, thin profile plastic Quad Flat Package (TQFP)
	64-pad, 9 × 9 × 1.0mm, Quad Flat No-Lead/Micro Lead Frame Package (QFN/MLF)

9.4 Atmel ATmega329PA

Speed [MHz] ⁽³⁾	Power supply	Ordering code ⁽²⁾	Package type ⁽¹⁾	Operational range
20	1.8 - 5.5V	ATmega329PA-AU ATmega329PA-AUR ⁽⁴⁾ ATmega329PA-MU ATmega329PA-MUR ⁽⁴⁾	64A 64A 64M1 64M1	Industrial (-40°C to 85°C)
		ATmega329PA-AN ATmega329PA-ANR ⁽⁴⁾ ATmega329PA-MN ATmega329PA-MNR ⁽⁴⁾	64A 64A 64M1 64M1	Extended (-40°C to 105°C) ⁽⁵⁾

- Notes:
1. This device can also be supplied in wafer form. Please contact your local Atmel sales office for detailed ordering information and minimum quantities.
 2. Pb-free packaging complies to the European Directive for Restriction of Hazardous Substances (RoHS directive). Also Halide free and fully Green.
 3. For Speed vs. V_{CC} see [Figure 29-2 on page 330](#).
 4. Tape & Reel.
 5. See characterization specification at 105°C.

Package type	
	64-lead, 14 × 14 × 1.0mm, thin profile Plastic Quad Flat Package (TQFP)
	64-pad, 9 × 9 × 1.0mm, Quad Flat No-Lead/Micro Lead Frame Package (QFN/MLF)

9.5 Atmel ATmega3290A

Speed [MHz] ⁽³⁾	Power supply	Ordering code ⁽²⁾	Package type ⁽¹⁾	Operational range
20	1.8 - 5.5V	ATmega3290A-AU ATmega3290A-AUR ⁽⁴⁾	100A 100A	Industrial (-40°C to 85°C)
		ATmega3290A-AN ATmega3290A-ANR ⁽⁴⁾	100A 100A	Extended (-40°C to 105°C) ⁽⁵⁾

- Notes:
1. This device can also be supplied in wafer form. Please contact your local Atmel sales office for detailed ordering information and minimum quantities.
 2. Pb-free packaging complies to the European Directive for Restriction of Hazardous Substances (RoHS directive). Also Halide free and fully Green.
 3. For Speed vs. V_{CC} see [Figure 29-2 on page 330](#).
 4. Tape & Reel.
 5. See characterization specification at 105°C.

Package type	
	100-lead, 14 × 14 × 1.0mm, 0.5mm Lead Pitch, Thin Profile Plastic Quad Flat Package (TQFP)

9.6 Atmel ATmega3290PA

Speed [MHz] ⁽³⁾	Power supply	Ordering code ⁽²⁾	Package type ⁽¹⁾	Operational range
20	1.8 - 5.5V	ATmega3290PA-AU ATmega3290PA-AUR ⁽⁴⁾	100A 100A	Industrial (-40°C to 85°C)
		ATmega3290PA-AN ATmega3290PA-ANR ⁽⁴⁾	100A 100A	Industrial (-40°C to 105°C) ⁽⁵⁾

- Notes:
1. This device can also be supplied in wafer form. Please contact your local Atmel sales office for detailed ordering information and minimum quantities.
 2. Pb-free packaging complies to the European Directive for Restriction of Hazardous Substances (RoHS directive). Also Halide free and fully Green.
 3. For Speed vs. V_{CC} see [Figure 29-2 on page 330](#).
 4. Tape & Reel.
 5. See characterization specification at 105°C.

Package type	
	100-lead, 14 × 14 × 1.0mm, 0.5mm Lead Pitch, Thin Profile Plastic Quad Flat Package (TQFP)

9.7 Atmel ATmega649A

Speed [MHz] ⁽³⁾	Power supply	Ordering code ⁽²⁾	Package type ⁽¹⁾	Operational range
16	1.8 - 5.5V	ATmega649A-AU ATmega649A-AUR ⁽⁴⁾ ATmega649A-MU ATmega649A-MUR ⁽⁴⁾	64A 64A 64M1 64M1	Industrial (-40°C to 85°C)

- Notes:
1. This device can also be supplied in wafer form. Please contact your local Atmel sales office for detailed ordering information and minimum quantities.
 2. Pb-free packaging complies to the European Directive for Restriction of Hazardous Substances (RoHS directive). Also Halide free and fully Green.
 3. For Speed vs. V_{CC} see [Figure 29-1 on page 330](#).
 4. Tape & Reel.

Package type	
	64-lead, 14 × 14 × 1.0mm, Thin Profile Plastic Quad Flat Package (TQFP)
	64-pad, 9 × 9 × 1.0mm, Quad Flat No-Lead/Micro Lead Frame Package (QFN/MLF)

9.8 Atmel ATmega649P

Speed [MHz] ⁽³⁾	Power supply	Ordering code ⁽²⁾	Package type ⁽¹⁾	Operational range
16	1.8 - 5.5 V	ATmega649P-AU ATmega649P-AUR ⁽⁴⁾ ATmega649P-MU ATmega649P-MUR ⁽⁴⁾	64A 64A 64M1 64M1	Industrial (-40°C to 85°C)

- Notes:
1. This device can also be supplied in wafer form. Please contact your local Atmel sales office for detailed ordering information and minimum quantities.
 2. Pb-free packaging complies to the European Directive for Restriction of Hazardous Substances (RoHS directive). Also Halide free and fully Green.
 3. For Speed vs. V_{CC} see [Figure 29-1 on page 330](#).
 4. Tape & Reel.

Package type	
	64-lead, 14 × 14 × 1.0mm, Thin Profile Plastic Quad Flat Package (TQFP)
	64-pad, 9 × 9 × 1.0mm, Quad Flat No-Lead/Micro Lead Frame Package (QFN/MLF)

9.9 Atmel ATmega6490A

Speed [MHz] ⁽³⁾	Power supply	Ordering code ⁽²⁾	Package type ⁽¹⁾	Operational range
20	1.8 - 5.5V	ATmega6490A-AU ATmega6490A-AUR ⁽⁴⁾	100A 100A	Industrial (-40°C to 85°C)

- Notes:
1. This device can also be supplied in wafer form. Please contact your local Atmel sales office for detailed ordering information and minimum quantities.
 2. Pb-free packaging complies to the European Directive for Restriction of Hazardous Substances (RoHS directive). Also Halide free and fully Green.
 3. For Speed vs. V_{CC} see [Figure 29-2 on page 330](#).
 4. Tape & Reel.

Package type	
	100-lead, 14 × 14 × 1.0mm, 0.5mm Lead Pitch, Thin Profile Plastic Quad Flat Package (TQFP)

9.10 Atmel ATmega6490P

Speed [MHz] ⁽³⁾	Power supply	Ordering code ⁽²⁾	Package type ⁽¹⁾	Operational range
20	1.8 - 5.5V	ATmega6490P-AU ATmega6490P-AUR ⁽⁴⁾	100A 100A	Industrial (-40°C to 85°C)

- Notes:
1. This device can also be supplied in wafer form. Please contact your local Atmel sales office for detailed ordering information and minimum quantities.
 2. Pb-free packaging complies to the European Directive for Restriction of Hazardous Substances (RoHS directive). Also Halide free and fully Green.
 3. For Speed vs. V_{CC} see [Figure 29-2 on page 330](#).
 4. Tape & Reel.

Package Type	
	100-lead, 14 × 14 × 1.0mm, 0.5mm Lead Pitch, Thin Profile Plastic Quad Flat Package (TQFP)

10. Packaging Information

10.1 64A

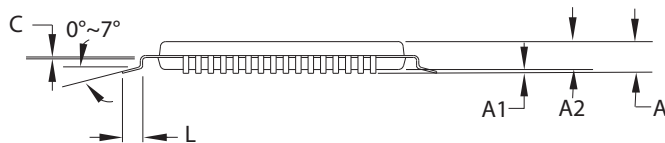
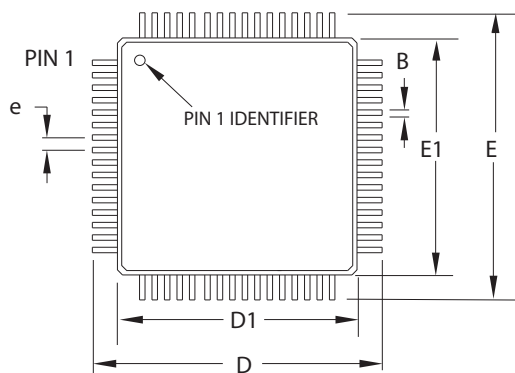

COMMON DIMENSIONS
(Unit of measure = mm)

SYMBOL	MIN	NOM	MAX	NOTE
A	-	-	1.20	
A1	0.05	-	0.15	
A2	0.95	1.00	1.05	
D	15.75	16.00	16.25	
D1	13.90	14.00	14.10	Note 2
E	15.75	16.00	16.25	
E1	13.90	14.00	14.10	Note 2
B	0.30-	0.45		
C	0.09	-	0.20	
L	0.45	-	0.75	
e	0.80 TYP			

Notes:

1. This package conforms to JEDEC reference MS-026, Variation AEB.
2. Dimensions D1 and E1 do not include mold protrusion. Allowable protrusion is 0.25mm per side. Dimensions D1 and E1 are maximum plastic body size dimensions including mold mismatch.
3. Lead coplanarity is 0.10mm maximum.

2010-10-20

	2325 Orchard Parkway San Jose, CA 95131	TITLE	DRAWING NO.	REV.
		64A, 64-lead, 14 x 14mm Body Size, 1.0mm Body Thickness, 0.8mm Lead Pitch, Thin Profile Plastic Quad Flat Package (TQFP)	64A	C

10.2 64M1

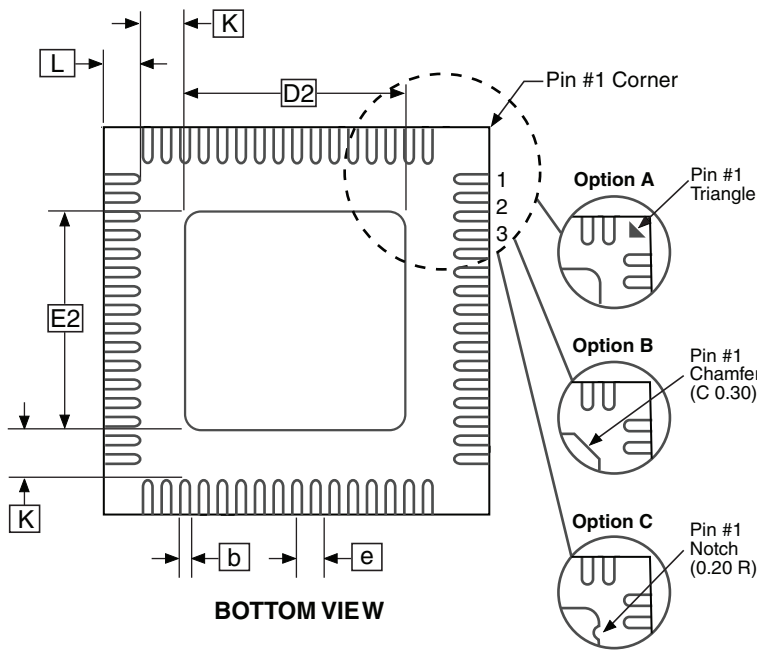
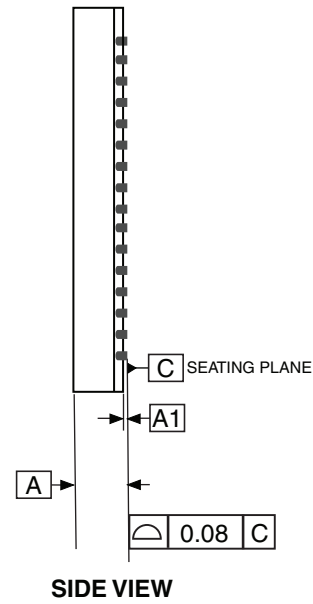
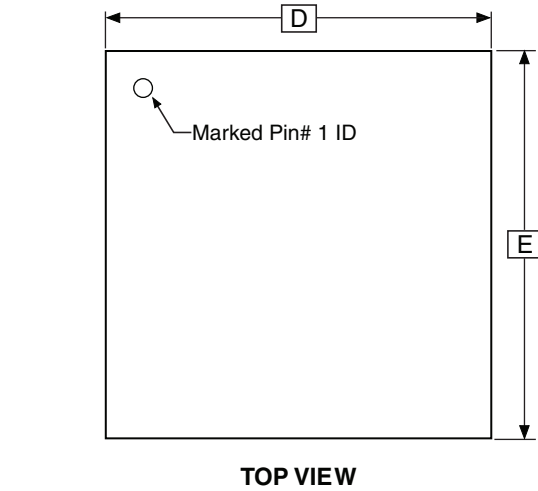

COMMON DIMENSIONS
(Unit of Measure = mm)

SYMBOL	MIN	NOM	MAX	NOTE
A	0.80	0.90	1.00	
A1	–	0.02	0.05	
b	0.18	0.25	0.30	
D	8.90	9.00	9.10	
D2	5.20	5.40	5.60	
E	8.90	9.00	9.10	
E2	5.20	5.40	5.60	
e	0.50 BSC			
L	0.35	0.40	0.45	
K	1.25	1.40	1.55	

- Notes:
1. JEDEC Standard MO-220, (SAW Singulation) Fig. 1, VMMD.
 2. Dimension and tolerance conform to ASMEY14.5M-1994.

2010-10-19

2325 Orchard Parkway San Jose, CA 95131	TITLE	DRAWING NO.	REV.
	64M1 , 64-pad, 9 x 9 x 1.0 mm Body, Lead Pitch 0.50 mm, 5.40 mm Exposed Pad, Micro Lead Frame Package (MLF)	64M1	H

10.3 64MC

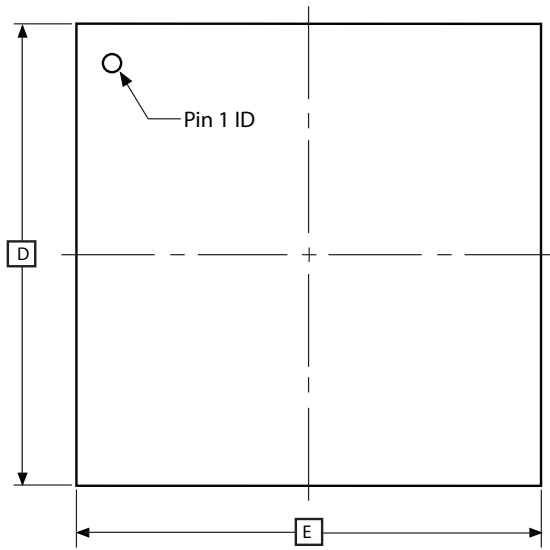

TOP VIEW

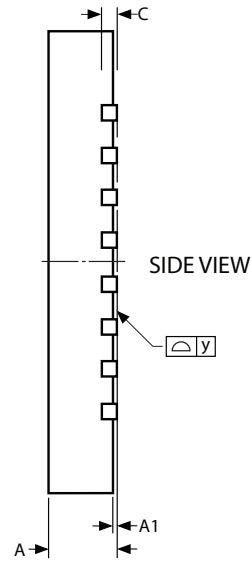

SIDE VIEW

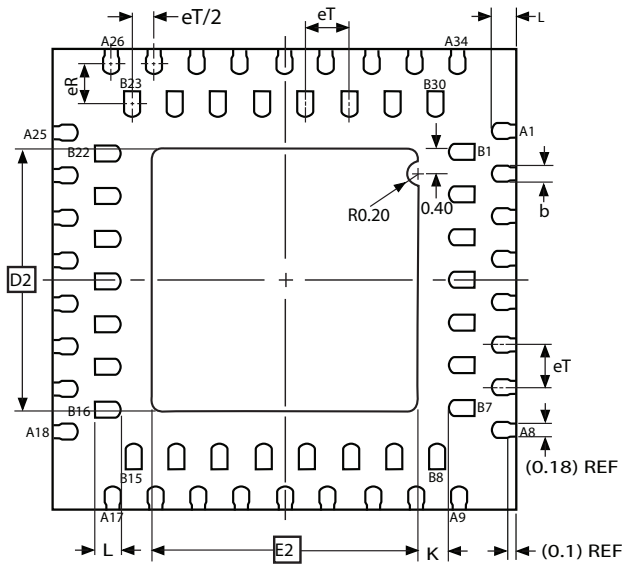

BOTTOM VIEW

COMMON DIMENSIONS
(Unit of Measure = mm)

SYMBOL	MIN	NOM	MAX	NOTE
A	0.80	0.90	1.00	
A1	0.00	0.02	0.05	
b	0.18	0.23	0.28	
C	0.20 REF			
D	6.90	7.00	7.10	
D2	3.95	4.00	4.05	
E	6.90	7.00	7.10	
E2	3.95	4.00	4.05	
eT	-	0.65	-	
eR	-	0.65	-	
K	0.20	-	-	(REF)
L	0.35	0.40	0.45	
y	0.00	-	0.075	

Note: 1. The terminal #1 ID is a Laser-marked Feature.

10/3/07

	Package Drawing Contact: packagedrawings@atmel.com	TITLE	GPC	DRAWING NO.	REV.
		64MC, 64QFN (2-Row Staggered), 7 x 7 x 1.00 mm Body, 4.0 x 4.0 mm Exposed Pad, Quad Flat No Lead Package	ZXC	64MC	A

10.4 100A

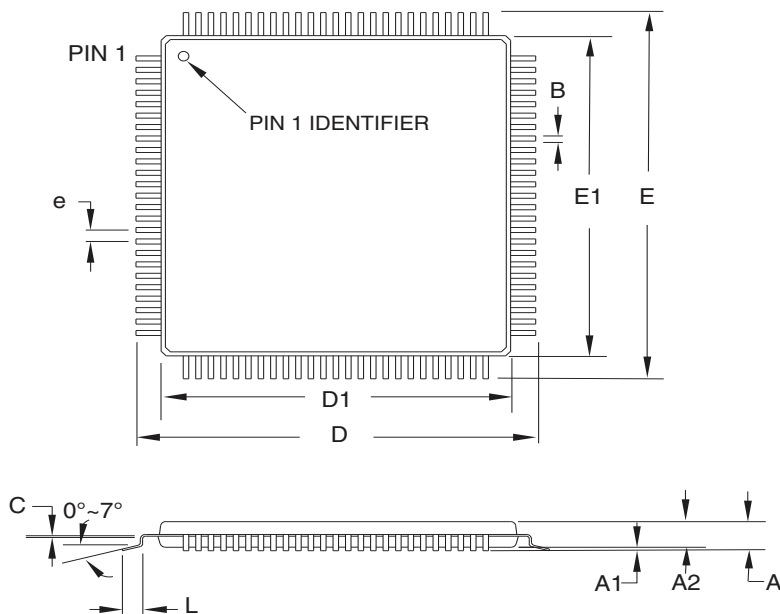

COMMON DIMENSIONS
(Unit of Measure = mm)

SYMBOL	MIN	NOM	MAX	NOTE
A	–	–	1.20	
A1	0.05	–	0.15	
A2	0.95	1.00	1.05	
D	15.75	16.00	16.25	
D1	13.90	14.00	14.10	Note 2
E	15.75	16.00	16.25	
E1	13.90	14.00	14.10	Note 2
B	0.17	–	0.27	
C	0.09	–	0.20	
L	0.45	–	0.75	
e	0.50 TYP			

Notes:

1. This package conforms to JEDEC reference MS-026, Variation AED.
2. Dimensions D1 and E1 do not include mold protrusion. Allowable protrusion is 0.25mm per side. Dimensions D1 and E1 are maximum plastic body size dimensions including mold mismatch.
3. Lead coplanarity is 0.08mm maximum.

2014-02-05

 Package Drawing Contact: packagedrawings@atmel.com	TITLE	DRAWING NO.	REV.
	100A , 100-lead, 14 x 14mm Body Size, 1.0mm Body Thickness, 0.5mm Lead Pitch, Thin Profile Plastic Quad Flat Package (TQFP)	100A	E

11. Errata

11.1 Atmel ATmega169A

No known errata

11.2 Atmel ATmega169A/169PA Rev. A to F

Not sampled.

11.3 Atmel ATmega169PA Rev. G

No known errata.

11.4 Atmel ATmega329A/329PA rev. A

- Interrupts may be lost when writing the timer registers in the asynchronous timer
- Using BOD disable will make the chip reset

1. Interrupts may be lost when writing the timer registers in the asynchronous timer

The interrupt will be lost if a timer register that is synchronous timer clock is written when the asynchronous Timer/Counter register (TCNTx) is 0x00.

Problem Fix/ Workaround

Always check that the asynchronous Timer/Counter register neither have the value 0xFF nor 0x00 before writing to the asynchronous Timer Control Register (TCCRx), asynchronous Timer Counter Register (TCNTx), or asynchronous Output Compare Register (OCRx).

2. Using BOD disable will make the chip reset

If the part enters sleep with the BOD turned off with the BOD disable option enabled, a BOD reset will be generated at wakeup and the chip will reset.

Problem Fix/Workaround

Do not use BOD disable

11.5 Atmel ATmega329A/329PA rev. B

- Interrupts may be lost when writing the timer registers in the asynchronous timer

1. Interrupts may be lost when writing the timer registers in the asynchronous timer

The interrupt will be lost if a timer register that is synchronous timer clock is written when the asynchronous Timer/Counter register (TCNTx) is 0x00.

Problem Fix/ Workaround

Always check that the asynchronous Timer/Counter register neither have the value 0xFF nor 0x00 before writing to the asynchronous Timer Control Register (TCCRx), asynchronous Timer Counter Register (TCNTx), or asynchronous Output Compare Register (OCRx).

11.6 Atmel ATmega329A/329PA rev. C

- Interrupts may be lost when writing the timer registers in the asynchronous timer

1. Interrupts may be lost when writing the timer registers in the asynchronous timer

The interrupt will be lost if a timer register that is synchronous timer clock is written when the asynchronous Timer/Counter register (TCNTx) is 0x00.

Problem Fix/ Workaround

Always check that the asynchronous Timer/Counter register neither have the value 0xFF nor 0x00 before writing to the asynchronous Timer Control Register (TCCRx), asynchronous Timer Counter Register (TCNTx), or asynchronous Output Compare Register (OCRx).

11.7 Atmel ATmega3290A/3290PA rev. A

- Interrupts may be lost when writing the timer registers in the asynchronous timer
- Using BOD disable will make the chip reset

1. Interrupts may be lost when writing the timer registers in the asynchronous timer

The interrupt will be lost if a timer register that is synchronous timer clock is written when the asynchronous Timer/Counter register (TCNTx) is 0x00.

Problem Fix/ Workaround

Always check that the asynchronous Timer/Counter register neither have the value 0xFF nor 0x00 before writing to the asynchronous Timer Control Register (TCCRx), asynchronous Timer Counter Register (TCNTx), or asynchronous Output Compare Register (OCRx).

2. Using BOD disable will make the chip reset

If the part enters sleep with the BOD turned off with the BOD disable option enabled, a BOD reset will be generated at wakeup and the chip will reset.

Problem Fix/Workaround

Do not use BOD disable

11.8 Atmel ATmega3290A/3290PA rev. B

- Interrupts may be lost when writing the timer registers in the asynchronous timer

1. Interrupts may be lost when writing the timer registers in the asynchronous timer

The interrupt will be lost if a timer register that is synchronous timer clock is written when the asynchronous Timer/Counter register (TCNTx) is 0x00.

Problem Fix/ Workaround

Always check that the asynchronous Timer/Counter register neither have the value 0xFF nor 0x00 before writing to the asynchronous Timer Control Register (TCCRx), asynchronous Timer Counter Register (TCNTx), or asynchronous Output Compare Register (OCRx).

11.9 Atmel ATmega3290A/3290PA rev. C

- Interrupts may be lost when writing the timer registers in the asynchronous timer

1. Interrupts may be lost when writing the timer registers in the asynchronous timer

The interrupt will be lost if a timer register that is synchronous timer clock is written when the asynchronous Timer/Counter register (TCNTx) is 0x00.

Problem Fix/ Workaround

Always check that the asynchronous Timer/Counter register neither have the value 0xFF nor 0x00 before writing to the asynchronous Timer Control Register (TCCRx), asynchronous Timer Counter Register (TCNTx), or asynchronous Output Compare Register (OCRx).

11.10 Atmel ATmega649A/649P/ATmega6490A/6490P

No known errata.

12. Datasheet revision history

Please note that the referring page numbers in this section are referring to this document. The referring revision in this section are referring to the document revision.

12.1 Rev. 8284F - 08/2014

1. New back page
2. Changed chip references in the text in [Section 9.6 "Low-frequency XTAL oscillator" on page 34](#).

12.2 Rev. 8284E - 02/2013

1. New template
2. Countless, small corrections made throughout the whole document
3. In Section ["System and reset characteristics" on page 332](#) the sentence "The following chara apply only to..." has been deleted
Former [Section 29.6 on page 332](#) ("Power-on reset"), subsection 29.6.1 ("ATmega169A/169PA/329A/329PA/3290A/3290PA/649A/649P/6490A/6490PA revision C and later") and subsection 29.6.2 ("ATmega329A/329PA/3290A/3290PA/649A/649P/6490A/6490PA revision A and B") have been deleted
4. The maximum limits for "Power Supply Current" in [Table 29-9 on page 328](#) have been corrected
5. The maximum limits for "Power Supply Current" in [Table 29-11 on page 329](#) have been corrected
6. Added ["Electrical Characteristics – TA = -40°C to 105°C" on page 337](#).
7. Added ["Typical Characteristics – TA = -40°C to 105°C" on page 658](#).
8. Updated ["Ordering information" on page 20](#)

12.3 Rev. 8284D - 06/11

1. Removed "Preliminary" from the front page
2. Updated the [Table 29-16 on page 344](#). V_{POT} falling / Min. is 0.05V, not 0.5V

12.4 Rev. 8284C - 06/11

1. Updated ["Signature Bytes" on page 294](#). A, P, and PA devices have different signature (0x002) bytes.
2. Updated all ["DC Characteristics" on page 323](#).

12.5 Rev. 8284B - 03/11

1. Updated the datasheet according to the Atmel new Brand Style Guide.
2. Updated all "Ordering information" on page 20.
3. Updated "Packaging Information" on page 30.

12.6 Rev. 8284A - 10/10

1. Initial revision



Atmel®, Atmel logo and combinations thereof, Enabling Unlimited Possibilities®, AVR® and others are registered trademarks or trademarks of Atmel Corporation in U.S. and other countries. Other terms and product names may be trademarks of others.

2014 Atmel Corporation. / Rev.: Atmel-8284FS-AVR-ATmega169A/PA/329A/PA/649A/P/3290A/PA/6490A/P-Datasheet_07/2014

DISCLAIMER: The information in this document is provided in connection with Atmel products. No license, express or implied, by estoppel or otherwise, to any intellectual property right is granted by this document or in connection with the sale of Atmel products. EXCEPT AS SET FORTH IN THE ATMEL TERMS AND CONDITIONS OF SALES LOCATED ON THE ATMEL WEBSITE, ATMEL ASSUMES NO LIABILITY WHATSOEVER AND DISCLAIMS ANY EXPRESS, IMPLIED OR STATUTORY WARRANTY RELATING TO ITS PRODUCTS INCLUDING, BUT NOT LIMITED TO, THE IMPLIED WARRANTY OF MERCHANTABILITY, FITNESS FOR A PARTICULAR PURPOSE, OR NON-INFRINGEMENT. IN NO EVENT SHALL ATMEL BE LIABLE FOR ANY DIRECT, INDIRECT, CONSEQUENTIAL, PUNITIVE, SPECIAL OR INCIDENTAL DAMAGES (INCLUDING, WITHOUT LIMITATION, DAMAGES FOR LOSS AND PROFITS, BUSINESS INTERRUPTION, OR LOSS OF INFORMATION) ARISING OUT OF THE USE OR INABILITY TO USE THIS DOCUMENT, EVEN IF ATMEL HAS BEEN ADVISED OF THE POSSIBILITY OF SUCH DAMAGES. Atmel makes no representations or warranties with respect to the accuracy or completeness of the contents of this document and reserves the right to make changes to specifications and products descriptions at any time without notice. Atmel does not make any commitment to update the information contained herein. Unless specifically provided otherwise, Atmel products are not suitable for, and shall not be used in, automotive applications. Atmel products are not intended, authorized, or warranted for use as components in applications intended to support or sustain life.

SAFETY-CRITICAL, MILITARY, AND AUTOMOTIVE APPLICATIONS DISCLAIMER: Atmel products are not designed for and will not be used in connection with any applications where the failure of such products would reasonably be expected to result in significant personal injury or death ("Safety-Critical Applications") without an Atmel officer's specific written consent. Safety-Critical Applications include, without limitation, life support devices and systems, equipment or systems for the operation of nuclear facilities and weapons systems. Atmel products are not designed nor intended for use in military or aerospace applications or environments unless specifically designated by Atmel as military-grade. Atmel products are not designed nor intended for use in automotive applications unless specifically designated by Atmel as automotive-grade.