

- Low Ripple and Noise
- High Efficiency Up To 83%
- Input / Output Isolation : 1K Vdc or 3K Vdc
- 100% Burn-In
- Input Filter With Internal Capacitor
- Custom Design Available
- Net Weight :1.5g or 1.7g Typical
- RoHS Converter Certified By SGS
- UL/cUL/IEC/EN 62368-1 Safety Approval

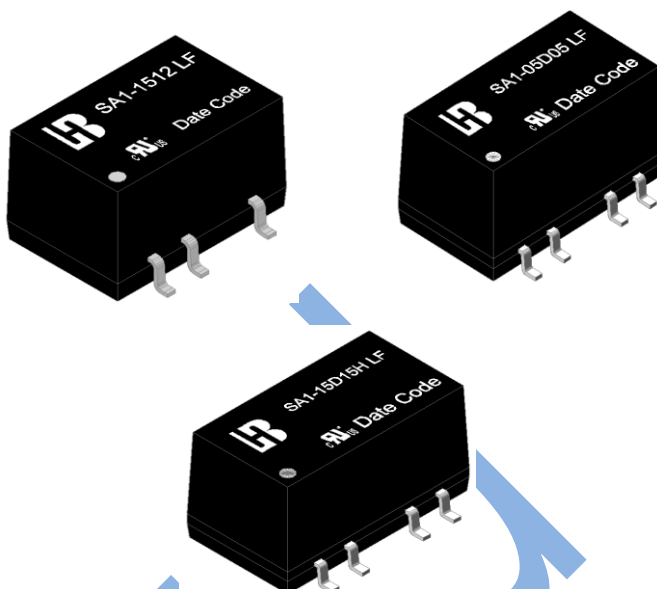

2 . Model Selection Guide

(Specifications typical at Ta= +25°C, Nominal input voltage, Rated output current unless otherwise noted)

Model No.	Input Voltage (Vdc)	Output Voltage (Vdc)	Output Current (mA) Max	Input Current @No Load (mA) Typ.	Input Current @Max. Load (mA) Typ.	Output Ripple (mV) Max.	Load Regulation (%) Max.	Efficiency (%)Typ.
Single Output Series (1 KVdc)								
SA1-3R33R3 LF	3.3	3.3	300	62	459	50	15	70
SA1-3R305 LF		5	200	68	446	60	15	72
SA1-3R309 LF		9	110	61	433	80	12	74
SA1-3R312 LF		12	84	59	421	100	10	76
SA1-3R315 LF		15	67	61	421	120	10	76
SA1-053R3 LF	5	3.3	300	41	290	50	15	73
SA1-0505 LF		5	200	40	282	60	15	75
SA1-0509 LF		9	110	39	270	80	12	78
SA1-0512 LF		12	84	25	263	100	10	80
SA1-0515 LF		15	67	44	270	120	10	78
SA1-123R3 LF	12	3.3	300	14	117	50	15	75
SA1-1205 LF		5	200	15	108	60	15	81
SA1-1209 LF		9	110	15	113	80	12	78
SA1-1212 LF		12	84	15	108	100	10	81
SA1-1215 LF		15	67	14	105	120	10	83
SA1-153R3 LF	15	3.3	300	11	88	50	15	76

SA1-1505 LF		5	200	11	85	60	15	79
SA1-1509 LF		9	110	10	88	80	12	76
SA1-1512 LF		12	84	10	85	100	10	79
SA1-1515 LF		15	67	10	84	120	10	80
SA1-243R3 LF		24	3.3	300	6	66	50	15
SA1-2405 LF	5		200	7	62	60	15	71
SA1-2409 LF	9		110	6	60	80	12	73
SA1-2412 LF	12		84	8	58	100	10	76
SA1-2415 LF	15		67	8	58	120	10	77
Dual Output Series (1 KVdc)								
SA1-3R3D3R3 LF	3.3	±3.3	±150	48	446	50	15	68
SA1-3R3D05 LF		±5	±100	48	433	60	15	70
SA1-3R3D09 LF		±9	±55	47	410	80	12	74
SA1-3R3D12 LF		±12	±42	46	400	100	10	76
SA1-3R3D15 LF		±15	±34	46	410	120	10	74
SA1-05D3R3 LF	5	±3.3	±150	35	270	50	15	74
SA1-05D05 LF		±5	±100	35	257	60	15	78
SA1-05D09 LF		±9	±55	33	267	80	12	75
SA1-05D12 LF		±12	±42	48	286	100	10	74
SA1-05D15 LF		±15	±34	33	257	120	10	78
SA1-12D3R3 LF	12	±3.3	±150	16	117	50	15	72
SA1-12D05 LF		±5	±100	15	108	60	15	78
SA1-12D09 LF		±9	±55	15	113	80	12	75
SA1-12D12 LF		±12	±42	15	108	100	10	78
SA1-12D15 LF		±15	±34	14	105	120	10	80
SA1-15D3R3 LF	15	±3.3	±150	12	93	50	15	72
SA1-15D05 LF		±5	±100	11	88	60	15	76
SA1-15D09 LF		±9	±55	11	88	80	12	76
SA1-15D12 LF		±12	±42	11	86	100	10	78
SA1-15D15 LF		±15	±34	10	86	120	10	78
SA1-24D3R3 LF	24	±3.3	±150	8	58	50	15	72
SA1-24D05 LF		±5	±100	8	58	60	15	72
SA1-24D09 LF		±9	±55	7	58	80	12	73
SA1-24D12 LF		±12	±42	7	55	100	10	76
SA1-24D15 LF		±15	±34	7	56	120	10	75
Single Output Series (3 KVdc)								
SA1-3R33R3H LF	3.3	3.3	300	47	446	50	15	68
SA1-3R305H LF		5	200	47	421	60	15	72

SA1-3R309H LF		9	110	47	400	80	12	76
SA1-3R312H LF		12	84	45	410	100	10	74
SA1-3R315H LF		15	67	45	410	120	10	74
SA1-053R3H LF	5	3.3	300	25	274	50	15	77
SA1-0505H LF		5	200	25	260	60	15	81
SA1-0509H LF		9	110	23	270	80	12	78
SA1-0512H LF		12	84	25	263	100	10	80
SA1-0515H LF		15	67	28	260	120	10	81
SA1-123R3H LF	12	3.3	300	14	117	50	15	75
SA1-1205H LF		5	200	20	117	60	15	75
SA1-1209H LF		9	110	15	113	80	12	78
SA1-1212H LF		12	84	15	108	100	10	81
SA1-1215H LF		15	67	14	109	120	10	83
SA1-153R3H LF	15	3.3	300	11	88	50	15	76
SA1-1505H LF		5	200	11	85	60	15	79
SA1-1509H LF		9	110	10	88	80	12	76
SA1-1512H LF		12	84	10	85	100	10	79
SA1-1515H LF		15	67	10	84	120	10	80
SA1-243R3H LF	24	3.3	300	6	66	50	15	67
SA1-2405H LF		5	200	7	62	60	15	71
SA1-2409H LF		9	110	6	60	80	12	73
SA1-2412H LF		12	84	8	58	100	10	76
SA1-2415H LF		15	67	8	58	120	10	77

Dual Output Series (3 KVdc)

SA1-3R3D3R3H LF	3.3	±3.3	±150	48	446	50	15	68
SA1-3R3D05H LF		±5	±100	48	433	60	15	70
SA1-3R3D09H LF		±9	±55	47	410	80	12	74
SA1-3R3D12H LF		±12	±42	46	400	100	10	76
SA1-3R3D15H LF		±15	±34	46	410	120	10	74
SA1-05D3R3H LF	5	±3.3	±150	35	270	50	15	74
SA1-05D05H LF		±5	±100	35	257	60	15	78
SA1-05D09H LF		±9	±55	33	267	80	12	75
SA1-05D12H LF		±12	±42	33	259	100	10	77
SA1-05D15H LF		±15	±34	33	257	120	10	78
SA1-12D3R3H LF	12	±3.3	±150	16	117	50	15	72
SA1-12D05H LF		±5	±100	15	108	60	15	78
SA1-12D09H LF		±9	±55	15	113	80	12	75
SA1-12D12H LF		±12	±42	15	108	100	10	78

SA1-12D15H LF		±15	±34	14	105	120	10	80
SA1-15D3R3H LF	15	±3.3	±150	12	93	50	15	72
SA1-15D05H LF		±5	±100	11	88	60	15	76
SA1-15D09H LF		±9	±55	11	88	80	12	76
SA1-15D12H LF		±12	±42	11	86	100	10	78
SA1-15D15H LF		±15	±34	10	86	120	10	78
SA1-24D3R3H LF		24	±3.3	±150	8	58	50	15
SA1-24D05H LF	±5		±100	8	58	60	15	72
SA1-24D09H LF	±9		±55	7	58	80	12	73
SA1-24D12H LF	±12		±42	7	55	100	10	76
SA1-24D15H LF	±15		±34	7	56	120	10	75

Notes :

1. Load regulation is for output current change from 10% to 100% Max .Load.

3 . Absolute Maximum Ratings

(Exceeding these values may damage the module. These are not continuous operating ratings)

Parameter	Condition	Min.	Typ.	Max.	Unit
Input Absolute Voltage Range	3.3V Input Model	-0.7	3.3	4.2	Vdc
	5V Input Model	-0.7	5	7	
	12V Input Model	-0.7	12	15	
	15V Input Model	-0.7	15	18	
	24V Input Model	-0.7	24	28	
Max. Output Power		---	---	1.0	W
Operation Temperature (Ambient Temperature)	Output Full Load	-40	---	+85	°C
Storage Temperature		-55	---	+125	
Lead Temperature 1.5 mm From Case For 10 Seconds		---	---	+260	
Peak Airflow Temperature With CECC 00802 Profile		---	---	+245	

4 . Nominal Input/Output Electrical Specifications

(Specifications typical at Ta= +25°C , Nominal input voltage, Rated output current unless otherwise noted)

Parameter	Condition	Min.	Typ.	Max.	Unit
Input Voltage Range	3.3V Input Model	2.97	3.3	3.63	Vdc
	5V Input Model	4.5	5	5.5	
	12V Input Model	10.8	12	13.2	
	15V Input Model	13.5	15	15.5	
	24V Input Model	21.6	24	26.4	
Output Voltage Accuracy	Nominal Input	---	3.0	5.0	%

Output Voltage Balance		---	---	±1.0	---
Switching Frequency		60	100	150	KHz
Temperature Coefficient		---	±0.01	±0.02	%/ °C
Isolation Voltage	60 Second	1000	---	---	Vdc
	60 Second	3000	---	---	Vdc
Isolation Resistance	500Vdc	1000	---	---	MΩ
Isolation Capacitance	3.3V Input Model	---	12	---	pF
	5V Input Model	---	16	---	
	12V Input Model	---	16	---	
	15V Input Model	---	16	---	
	24V Input Model	---	16	---	
Max. Line Regulation (Per1.0% change in input change)	---	---	---	1.5	%

5 . General Specification

Parameter	Specification	Condition
Isolation Voltage	1000 Vdc	Test Duration 60 Seconds / 0.5 mA
Isolation Resistance	1000 MΩ Min.	@ 500 Vdc
Operating Temperature	-40°C ~ +85°C	@ Ambient Temperature With Natural Convection
Maximum case temperature	105°C	---
Storage Temperature	-55°C ~ +125°C	---
Humidity	Up To 90 %	---
Cooling	Free Air Convection	---

6 . Ordering Information

SA1-xxSyyH LF

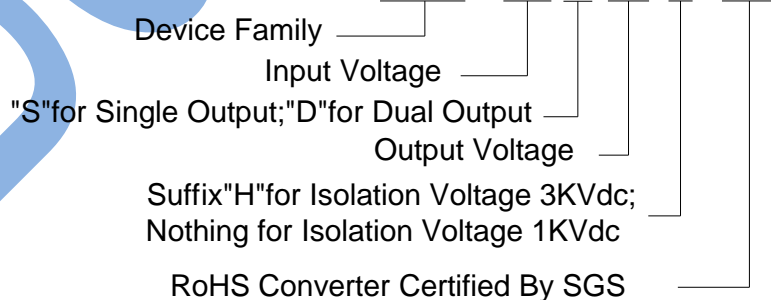

7 . Performance Characteristics

Temperature derating graph

Power Derating Curve

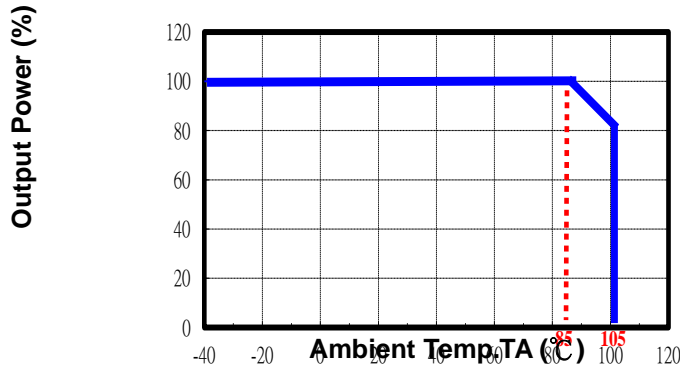

8 . Mechanical & Pin Connections

Single Output Series (For Isolation Voltage 1KVdc)

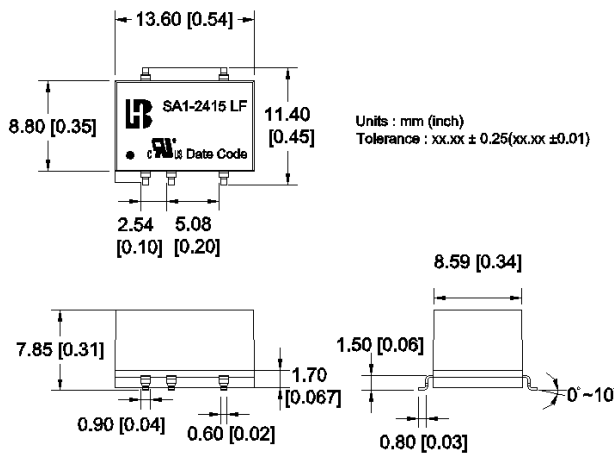

Pin	1 KVdc - Single		Pin
1	-Vi	NC	14
3	+Vi		12
5	---	---	10
7	-Vo	+Vo	8

Dual Output Series (For Isolation Voltage 1KVdc)

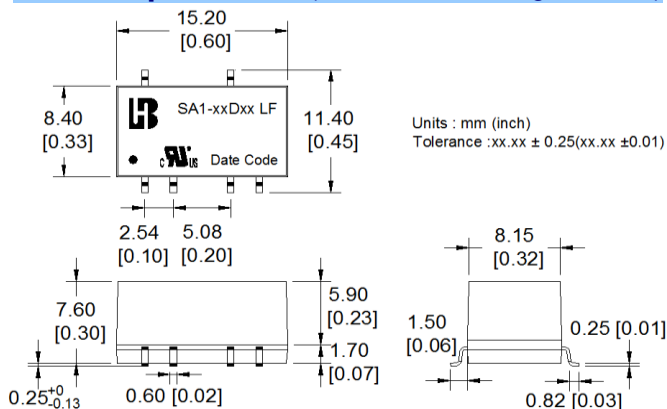

Pin	1K Vdc - Dual		Pin
1	-Vin	NC	18
3	+Vin	No Pin	16
5	No Pin		14
7	com	+Vo	12
9	-Vo	No Pin	10

Single Output Series (For Isolation Voltage 3KVdc)

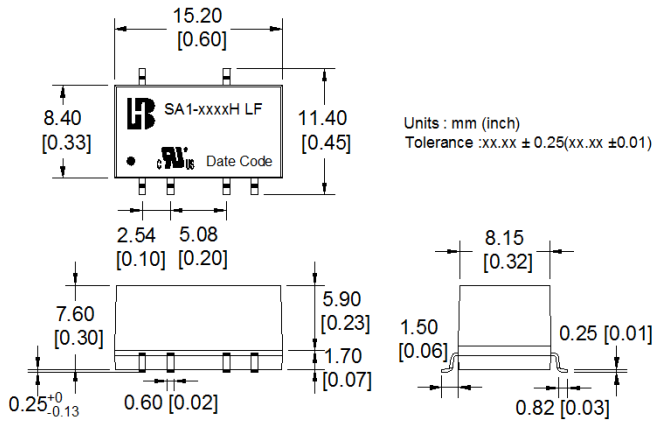

Pin	3K Vdc - Single		Pin
1	-Vin	NC	18
3	+Vin	No Pin	16
5	No Pin		14
7	-Vo	+Vo	12
9	NC	No Pin	10

Dual Output Series (For Isolation Voltage 3KVdc)

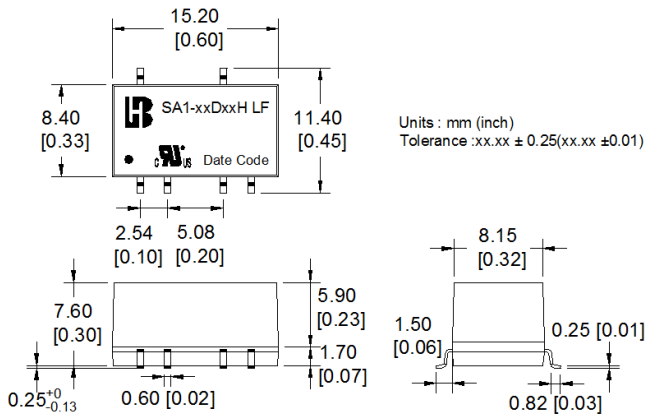

Pin	3K Vdc - Dual		Pin
1	-Vin	NC	18
3	+Vin	No Pin	16
5	No Pin		14
7	com	+Vo	12
9	-Vo	No Pin	10

9. Recommended Footprint Details

Single Output Series

For Isolation Voltage 1KVdc

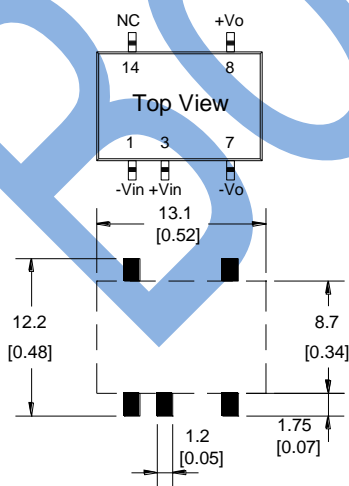

Dual Output Series

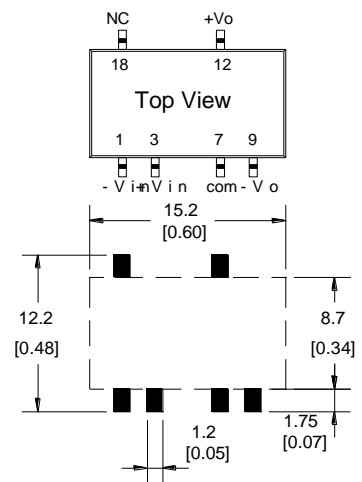

For Isolation Voltage 3KVdc

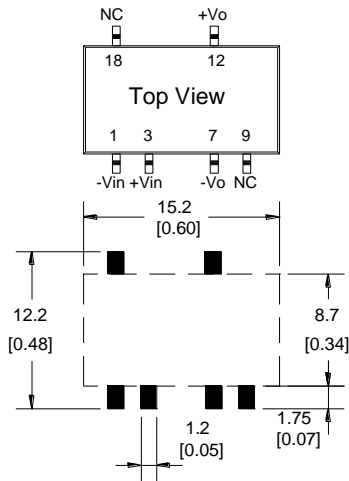

Units : mm (inch)
Tolerance : 0.xx ϕ 0.25(0.xx ϕ 0.01)

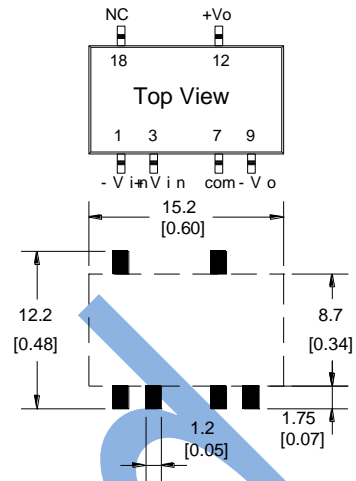

10. Package

Single Output Series For Isolation 1KVdc

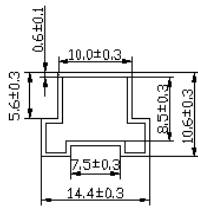

TUBE MECHANICAL DIMENSION

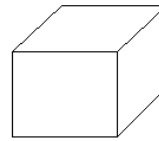
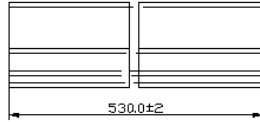

INNER CARTON:567*135*125

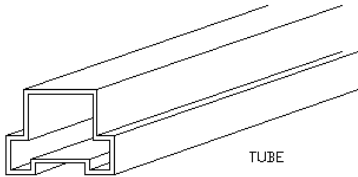

TUBE

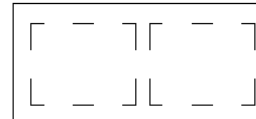

EXPORT CARTON:598*287*150

1. TUBE=37PCS
2. INNER CARTON=63 TUBE=63*37=2331PCS
3. EXPORT CARTON=4 INNER CARTON=2*2331=4662PCS

Single Output Series For Isolation 3KVdc

Dual Output Series For Isolation 1KVdc and 3KVdc

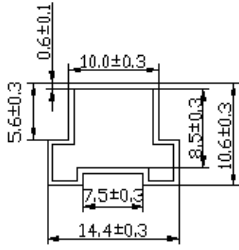

TUBE MECHANICAL DIMENSION

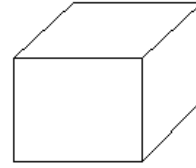
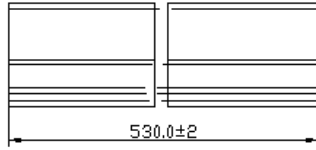

INNER CARTON:567*135*125

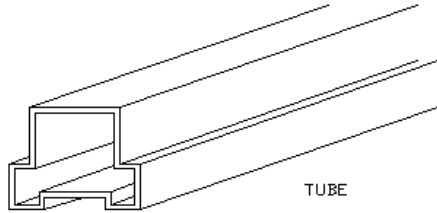

TUBE

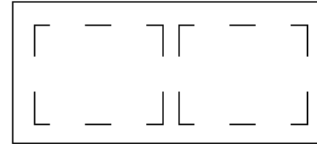

EXPORT CARTON:598*287*150

1. TUBE=33PCS
2. INNER CARTON=63 TUBE=63*33=2079PCS
3. EXPORT CARTON=4 INNER CARTON=2*2079=4158PCS

Single Output Series For Isolation 1KVdc

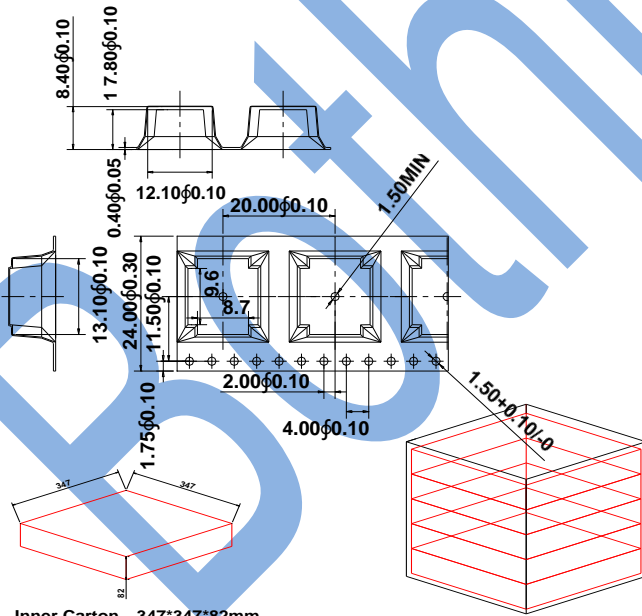

Inner Carton 347*347*82mm

Export Carton:375*375*460mm

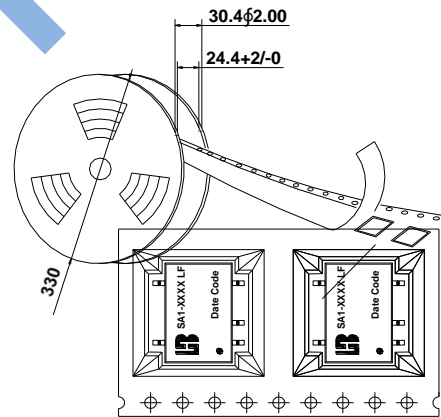

- 1 Packaging Number of 13":350PCS/R
- 2 Inner Carton=1 R=1*350=350PCS
- 3 Export Carton=5 Inner Carton=5*350=1750PCS

Single Output Series For Isolation 3KVdc

Dual Output Series For Isolation 1KVdc and 3KVdc

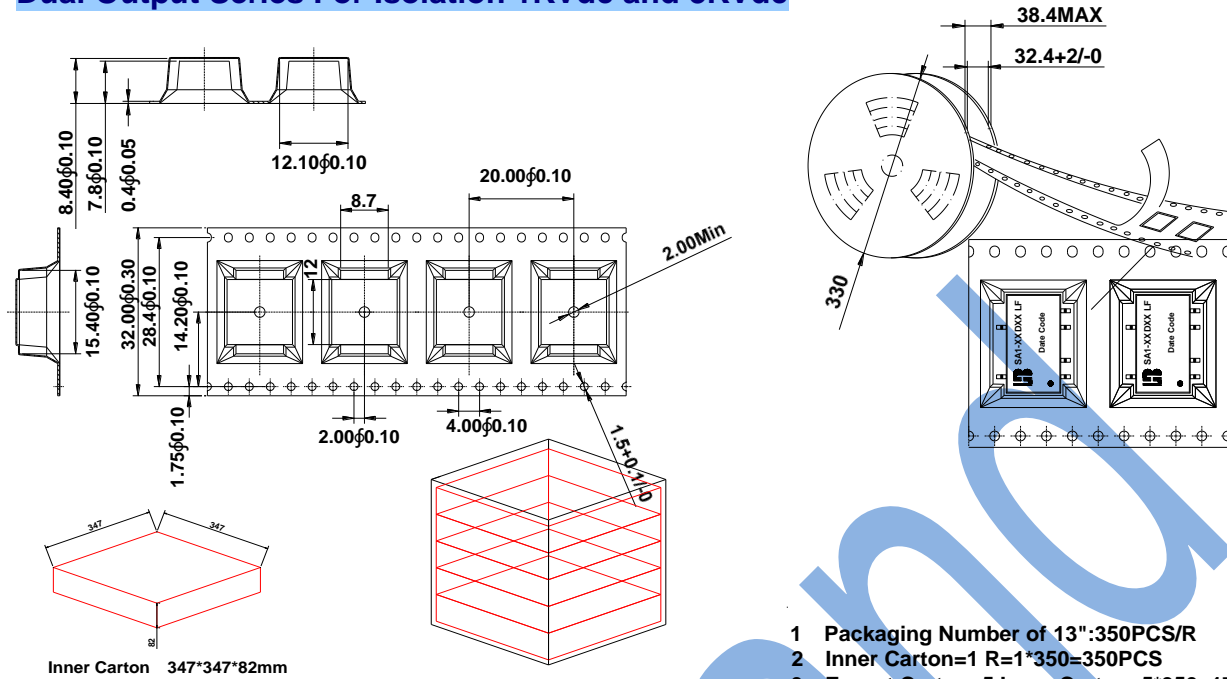

Inner Carton 347*347*82mm

Export Carton:375*375*460mm

- 1 Packaging Number of 13":350PCS/R
- 2 Inner Carton=1 R=1*350=350PCS
- 3 Export Carton=5 Inner Carton=5*350=1750PCS

Application note

Test Configurations :

All specifications are typical at nominal input, full load and 25 °C unless otherwise stated.

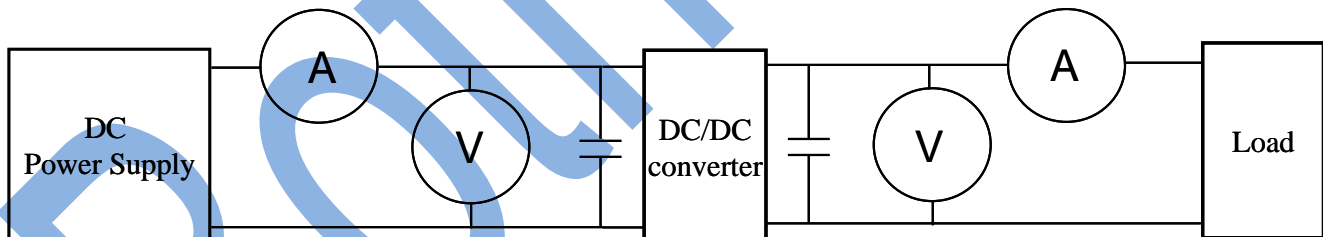

⊙DC Power Supply: It offers a wide voltage and current range precisely.

⊙Current meter (A): Accuracy → 200μA ~ 200mA 4 ranges ±(0.2% rdg + 2 digits)

2000mA ~ 20A 2 ranges ±(0.3% rdg + 2 digits).

⊙Voltage meter (V): Accuracy → ±(0.03% rdg + 4 digits).

⊙Load: At full load.

⊙Wires: The resistance of the wires must be small.

1. Input voltage range: Narrow input voltage range (±10%)、wide input voltage range (2:1 and

4:1)。

EX: Narrow input voltage range (±10%)

5VDC nominal input	➔	4.5~5.5VDC
12VDC nominal input	➔	10.8~13.2VDC
24VDC nominal input	➔	21.6~26.4VDC

Wide input voltage range 2:1

5VDC nominal input	➔	4.5~9VDC
12VDC nominal input	➔	9~18VDC
24VDC nominal input	➔	18~36VDC
48VDC nominal input	➔	36~75VDC

Wide input voltage range 4:1 (W)

24VDC nominal input	➔	9~36VDC
48VDC nominal input	➔	18~75VDC

2. Input power :

$$P_{in} = V_{in} \times I_{in}$$

V_{in} : Input voltage

I_{in} : Input current

3. Output power :

$$P_{out} = V_{out} \times I_{out}$$

V_{out} : Output voltage

I_{out} : Output current

4. Efficiency :

$$\text{Efficiency} = \frac{P_{out}}{P_{in}} \times 100\%$$

P_{out} : Output power

P_{in} : Input power

5. Voltage accuracy:

$$\frac{|V_{out} - V_{out(nominal)}|}{V_{out}} \times 100\%$$

V_{out} : Output voltage

$V_{out(nominal)}$: Nominal output voltage

6. Line regulation: (1) Wide input voltage range and regulated output voltage series.

$$\frac{|V_{out(LL)} - V_{out(HL)}|}{V_{out(LL)}} \times 100\%$$

LL: Low Line input voltage
HL: High Line input voltage

(2) Narrow input voltage range (±10%) and unregulated output voltage series.

$$\text{Line regulation} = \frac{\Delta V_{out}}{\Delta V_{in}}$$

$$\Delta V_{out} = \frac{V_{out(+10\%)} - V_{out(-10\%)}}{V_{out}} \times 100\%$$

$V_{out(+10\%)}$: Output voltage at $V_{in} = 1.1 \times V_{in(nominal)}$ & full load

$V_{out(-10\%)}$: Output voltage at $V_{in} = 0.9 \times V_{in(nominal)}$ & full load

V_{out} : Output voltage at $V_{in} = V_{in(nominal)}$ & full load

$$\Delta V_{in} = \frac{V_{in(+10\%)} - V_{in(-10\%)}}{V_{in(nominal)}} \times 100\%$$

$V_{in(+10\%)}$: Input voltage = $1.1 \times V_{in(nominal)}$

$V_{in(-10\%)}$: Input voltage = $0.9 \times V_{in(nominal)}$

$V_{in(nominal)}$: Nominal Input voltage

7. Load regulation :

$$\frac{|V_{out(FL)} - V_{out(NL)}|}{V_{out(FL)}} \times 100\%$$

$V_{out(FL)}$: Output voltage at full load

$V_{out(NL)}$: Output voltage at 25% full load or 10% full load

8. Ripple and Noise: as shown below. The bandwidth is 0-20MHz.

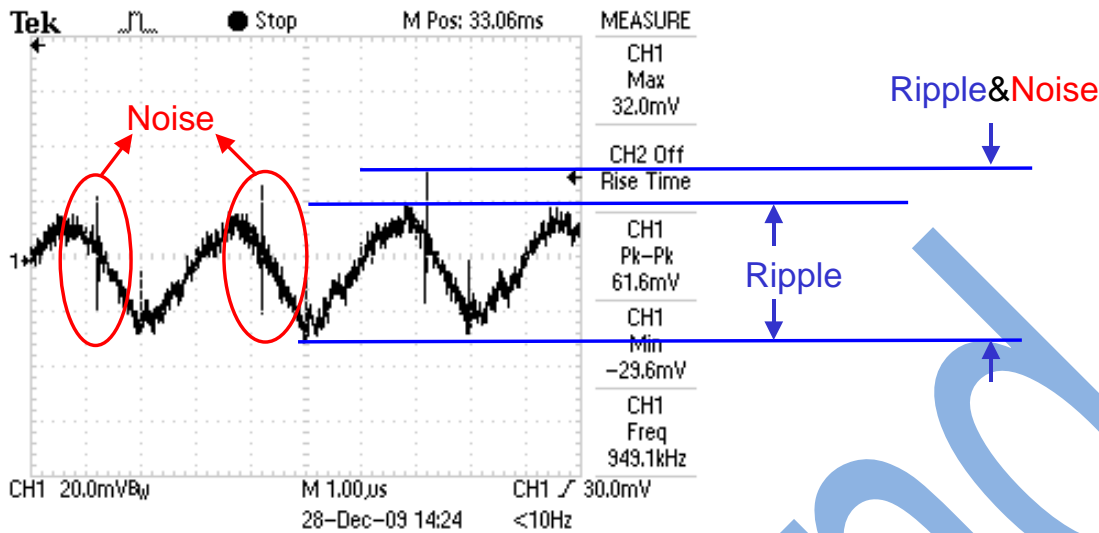

Output Ripple&Noise measurement test circuit: as shown below.

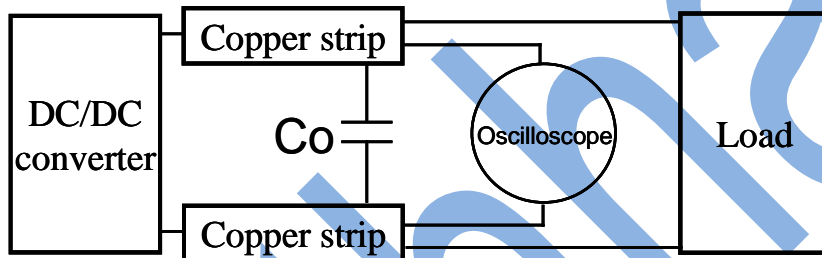

Co: usually 0.47uF.

1. Temperature derating curve: The DC-DC converter will operate over a wider temperature range if less power is drawn from the output and the device is already running. The temperature derating curve shows the operating power-temperature range. As shown below.

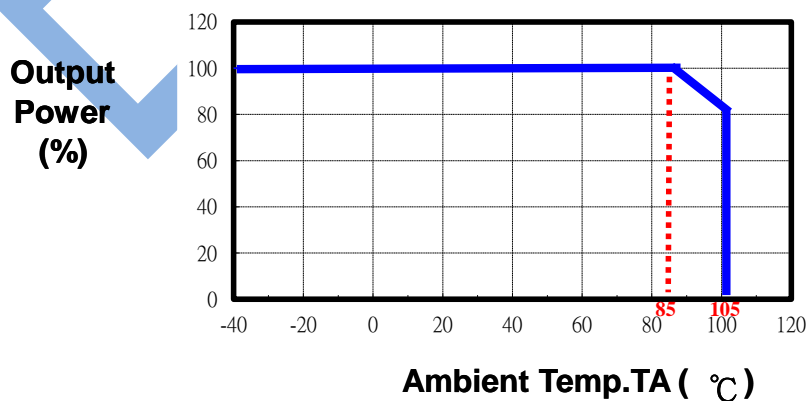

10. Switching frequency: The nominal operating frequency of the DC-DC converters.

11. Input to output isolation: The dielectric breakdown strength test between input and output circuits. This is the isolation voltage the device is capable of withstanding for a specified time, usually 1 second or 1 minute.

Pb-free SMD Peakage AIR Reflow Profile

Step#	Profile Feature	Condition / Duration
Step1	Ramp-up rate	3°C/sec max
Step2	Preheat : 150~200°C	Ta-Tb: 60-120 sec
Step3	Ramp-up rate (TL to Tp)	3°C/sec max
	Temperature maintained above 217°C (TL)	tL:60-150sec
Step4	Peak temperature (Tp)	245+0°C/-5°C
	The Time of Actual peak temperature	20-30sec
Step5	Ramp-down rate	6°C/sec max
Note1	All temperatures refer to topside of the package, measured on the package body surface.	
Note2	Time 25°C to peak temperature: 8 minutes max	
Note3	It is not allowed to make a forced cooling in temperature falling range.	

