

T92 Series Two-pole Power Relay

- 30/40/50A switching capability
- Designed to control compressor loads to 3.5 tons, 110LRA / 25.3FLA
- Meets requirements of UL 508 and UL 873 spacings - 8mm through air, 9.5mm over surface
- Meets requirements of VDE 8mm spacing, 4kV dielectric coil-to-contact
- Meets requirements of UL Class F construction
- UL approved for 600VAC switching (1.5HP)
- Screw terminal version (consult factory for availability, ratings)
- Anti-explosive version available (Meets EN 60079-15)
- WG version available (Meets EN 60335-1)



Typical applications
HVAC, residential / commercial appliances, industrial controls, charging

Approvals

UL E22575; CSA LR48471; VDE 40019600
Technical data of approved types on request.

Contact Data

Type	T92	T92H
Contact arrangement	2 form A (NO) 2 form C (CO)	2 form A (NO)
Rated voltage	277VAC	
Max. switching voltage	600VAC	
Rated current	30A/40A NO; 3A NC	50A NO
Overload current*	60A NO; 4.5A NC	75A NO
Contact material	Ag Alloy	
Min. recommended contact load	500mA (NO), 12VAC or 5VDC 100mA (NC), 12VAC or 5VDC	
Frequency of operation, with load	360 cycles per hour	
Operate/release time max., including bounce	25/25ms	
Initial contact resistance	< 100 mΩ at 6VDC 1A	

*Note: Minimum electrical endurance 50 cycles

Contact ratings¹⁾ (T92H Type)

Type	Load	Cycles
UL508		
NO	50A, 277VAC, resistive, 85°C	6x10 ³

Note: Coil voltage 12-48VDC covered in UL approval

Contact ratings¹⁾ (T92 Type)

Type	Load	Cycles
UL508		
AgCdO		
NO	40A, 277VAC, resistive	6x10 ³
NO	30A, 120/277VAC, resistive	100x10 ³
NO	10A, 600VAC, general purpose	100x10 ³
NO	1HP, 120VAC	100x10 ³
NO	3HP, 240VAC	1x10 ³
NO	1.5HP, 480 or 600VAC	100x10 ³
NO	110LRA/25.3FLA, 240VAC (DC coil only)	100x10 ³
NO	60LRA/14FLA, 240VAC (AC coil only)	100x10 ³
NO	3A, 240VAC, pilot duty	100x10 ³
NO	20A, 28VDC, resistive	100x10 ³
NO	TV10, 120VAC	100x10 ³
NC	3A, 277VAC	100x10 ³
NC	2A, 480VAC	100x10 ³
NC	1A, 600VAC	100x10 ³

Contact ratings¹⁾ (T92 Type) (continued)

Type	Load	Cycles
AgSnOInO		
NO	40A, 240VAC, resistive 85°C	50x10 ³
NO	30A, 120/277VAC, resistive (DC coil only)	200x10 ³
NO	30A, 120/277VAC, resistive (AC coil only)	100x10 ³
NO	20A, 480VAC, resistive	100x10 ³
NO	1.5HP, 120VAC, 2 pole making/breaking (Fig.1)	100x10 ³
NO	3HP, 240VAC, 3 phase (DC coil only)	100x10 ³
NO	3HP, 480VAC, 3 phase (DC coil only)	100x10 ³
NO	2HP, 600VAC, 3 phase (DC coil only)	100x10 ³
Special Ag Alloy X (Cd Free), wash tight		
NO	30A, 250VAC, resistive	100x10 ³
NO	30A, 400VAC, resistive	100x10 ³
NO	20A, 480VAC, resistive	100x10 ³

VDE

AgCdO, flange mount relays		
NO	20A, 400VAC	100x10 ³
NC	3A, 400VAC	30x10 ³
CO	20A NO / 3A NC, 400VAC	30x10 ³
AgCdO, PC mount relays		
NO	30A, 400VAC	100x10 ³
NC	3A, 400VAC	30x10 ³
CO	30A NO / 3A NC, 400VAC	30x10 ³

Anti-explosion, sealed type

NO	30A 250VAC, 25°C	100x10 ³
Anti-explosion, break device		
NO	15A 480VAC	100x10 ³

ARI 780-86 Endurance Test (section 6.6):

HVAC Definite Purpose Contactor Standard
Normally Open Contacts
Single Phase/Two Pole (Both poles together switching a single load)
110 LRA, 25.3 FLA, 200K operations (DC Coil)

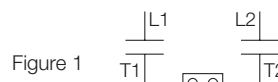

Figure 1

Single Phase Per Pole (Single load per pole)
110 LRA, 18 FLA, 200K operations (DC Coil).
60 LRA, 14 FLA, 200K operations (AC Coil).

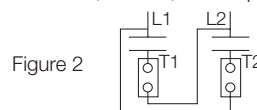

Figure 2

¹⁾ Contact ratings at 25°C (unless otherwise noted) with relay properly vented.
FLA, LRA ratings are compatible with 3.5 ton compressor applications.

Mechanical endurance	
T92	10x10 ⁶ ops.
T92H	1x10 ⁶ ops.

T92 Series Two-pole Power Relay (Continued)

Coil Data

Coil voltage range	5 to 110VDC; 12 to 240VAC
Max. coil power	1.7W; 4.0VA
Max. coil temperature	155°C
Coil insulation system according UL	Class F

Coil versions, DC coil (D type)

Coil code	Rated voltage ²⁾ VDC	Operate voltage VDC	Release voltage VDC	Coil resistance $\Omega \pm 10\%$	Rated coil power W
5	5	3.75	0.6	14.9	
6	6	4.5	0.6	22	
9	9	6.75	0.9	48	
12	12	9	1.2	86	
18	18	13.5	1.8	197	1.7W/
22	22	16.5	2.2	294	Min. 0.41W
24	24	18	2.4	350	hold
36	36	27	3.6	767	
48	48	36	4.8	1390	
110	110	82.5	11	7255	
120	120	90	12	8514	

2) For T92H type, after the energization time of 100ms with rated voltage, the coil requires a reduction of the coil voltage to 50% of rated voltage.

Coil versions, AC coil (A type)

Coil code	Rated voltage VAC	Frequency Hz	Operate voltage VAC, 60Hz	Release voltage VAC, 60Hz	Coil resistance $\Omega \pm 10\%$	Rated coil power VA
12	12	60	9.6	1.2	9.1	4
24	24	60	19.2	2.4	36.6	4
110	110	60	88	11	793	4
120	110/120	50/60	96	12	950	4
208	208	60	166.4	20.8	2841	4
240	220/240	50/60	192	24	3800	4
277	250/277	50/60	221.6	27.7	5485	4

Coil versions, AC coil (F type)

Coil code	Rated voltage VAC	Frequency Hz	Operate voltage VAC, 60Hz	Release voltage VAC, 60Hz	Coil resistance $\Omega \pm 10\%$	Rated coil power VA
12	12	50	9.6	1.2	11.2	3.5
24	24	50	19.2	2.4	44.4	3.5
48	48	50	38.4	4.8	179.2	3.5
240	240	50	192	24	4355	3.5

All figures are given for coil without preenergization, at ambient temperature +23°C. For A type, 110V/120V, 50/60Hz. Signify 50Hz Operation at Nominal 110V, 60 Hz Operation at Nominal 120V.

Coil Data (continued)

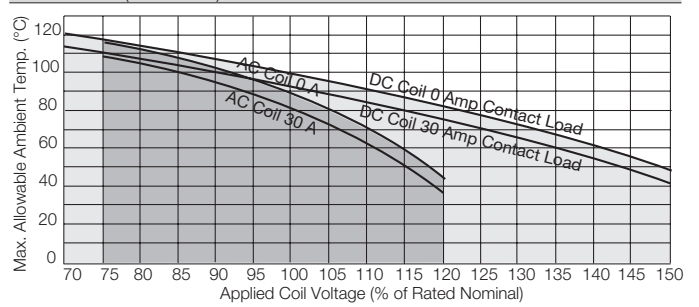

Insulation Data

Initial dielectric strength	
between open contacts	1500V _{rms}
between contact and coil	4000V _{rms}
between adjacent contact	2000V _{rms}
Initial surge withstand voltage	
between contact and coil	8kV
Initial insulation resistance	
between insulated elements	1x10 ⁹ Ω
Clearance/creepage	
between contact and coil	8mm clearance/9.5mm creepage

Other Data

Material compliance: EU RoHS/ELV, China RoHS, REACH, Halogen content refer to the Product Compliance Support Center at www.te.com/customer-support/rohssupportcenter	
Ambient temperature	
DC coil	-55°C to 85°C
AC coil	-55°C to 65°C
Category of environmental protection	IEC 61810
	RTI - dust protected, RTII - flux proof, RTIII - wash tight
Vibration resistance (functional)	1.65mm max amplitude, 10-55 Hz
Shock resistance (functional)	10G for 11msec
Shock resistance (destructive)	100G
Terminal type	PCB / Quick Connect / Screw
Weight	86g
Resistance to soldering heat (for PCB Terminal)	
IEC 60068-2-20	260°C, 10s
Packaging/unit	tray/30 pcs., box/120 pcs.

T92 Series Two-pole Power Relay (Continued)

Dimensions

T92/T92H – Mounting and termination code 1

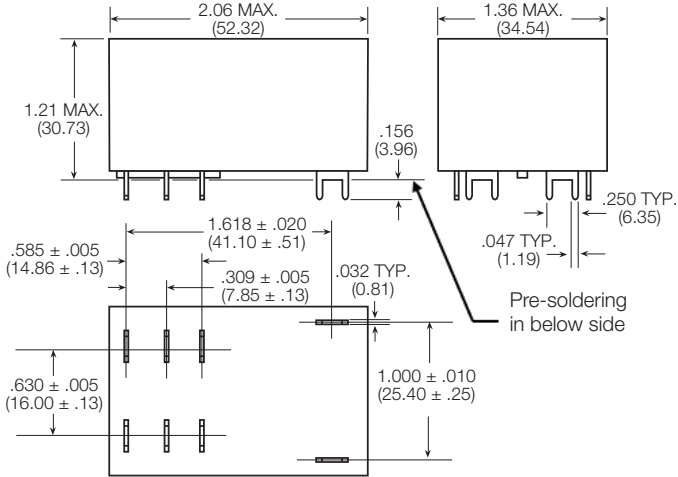

T92 – Mounting and termination code 2, 3 and 4

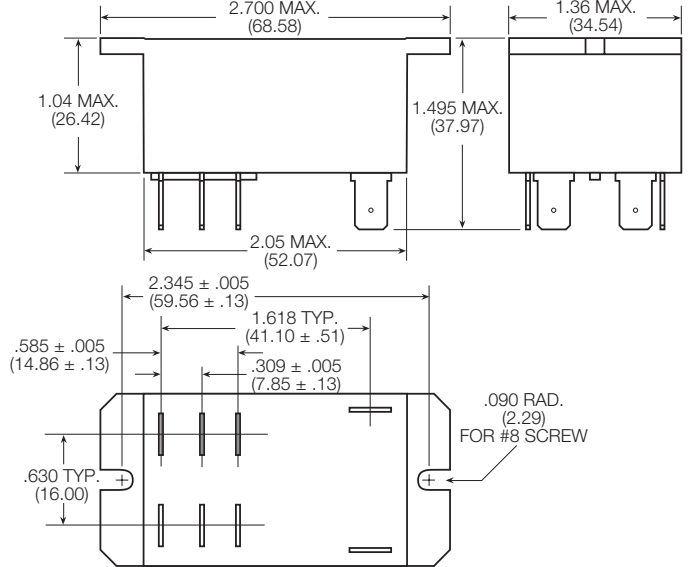

T92 – Mounting and termination code 5

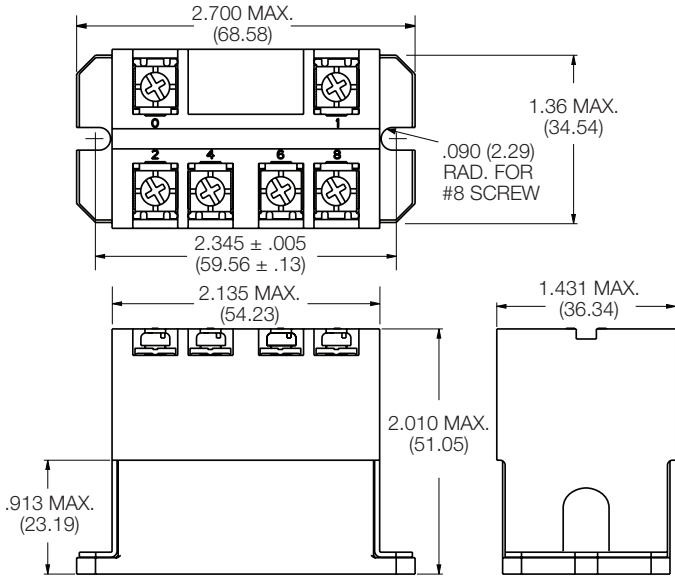

PCB layout

Bottom view on pins

T92/T92H - Mounting and termination code 1

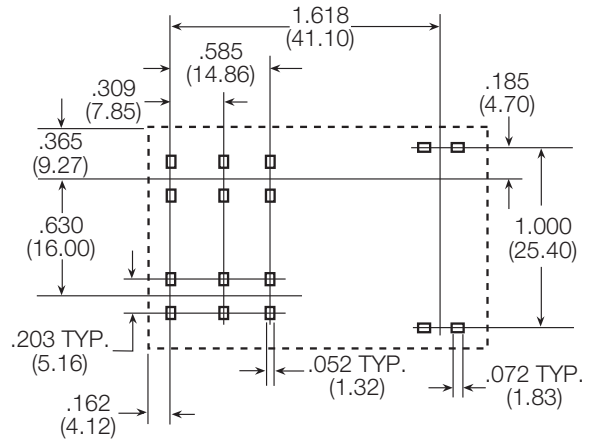

An alternate PC board layout utilizes .076 ± .003 (1.93 ± .076) diameter holes on the same center-to-center spacing shown above. Use of the rectangular holes is recommended for improved solderability.

Only necessary terminals are present on single throw models. Consequently, some holes will be unnecessary for single throw models.

Terminal assignment

Bottom view on pins

2 form A

2 form C

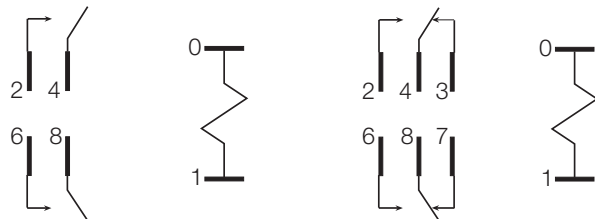

T92 Series Two-pole Power Relay (Continued)

Product code structure (T92H type)		Typical product code	T92H	P	7	D	1	X	-12
Type		T92H Power relay T92 High Performance (50A)							
Enclosure		P Dust protected plastic case S Wash-tight, tape sealed, plastic case (Mounting and termination code 1)							
Contact arrangement		7 2 form A (2 NO)							
Coil Input		D DC voltage							
Mounting and termination		1 Printed circuit board mount; printed circuit board terminals.							
Contact material		X Special Ag Alloy X (Cd Free)							
Coil voltage		Coil code: please refer to coil versions table							

Product code	Enclosure	Contacts	Coil	Mounting	Contact Material	Coil	Part number
T92HP7D1X-12	Plastic dust cover	2 form A, 2 NO	DC	PCB terminals	Special Ag Alloy X (Cd Free)	12VDC	6-1423008-6
T92HP7D1X-24						24VDC	6-1423008-7
T92HP7D1X-48						48VDC	6-1423008-9

Note. This list represents the most common types and does not show all variants covered by this datasheet, other types on request.

Product code structure (T92 type)

Product code structure		Typical product code	T92	S	11	D	2	2	-24	-99
Type		T92 Printed circuit board / panel mount power relay T92								
Enclosure		P Dust protected plastic case S Wash-tight, tape sealed, plastic case (Mounting and termination code 1) Wash-tight, glue sealed, plastic case (Mounting and termination code 1, 2 for anti-explosion version) Top sealed, not wash-tight, not tape sealed on bottom (Mounting and termination codes 2, 3 & 4)								
Contact arrangement		7 2 form A (2 NO) 11 2 form C (2 CO)								
Coil Input		A AC voltage, 60Hz or 50/60 Hz (consult coil versions table) D DC voltage F AC voltage, 50Hz								
Mounting and termination		1 Printed circuit board mount; printed circuit board terminals. 2 Panel mount via flanged cover; .250" (6.35mm) x .032" (.81mm) QC terminal 3 Panel mount via flanged cover; .187" (4.75mm) x .032" (.81mm) QC terminals for coil and .250" (6.35mm) for contacts 4 Panel mount via flanged cover, .187" (4.75mm) x .020" (.51mm) QC terminals for coil and .250" (6.35mm) for contacts. 5 Panel mount via flanged cover, M4 screws w/ captive pressure plates. Requires Enclosure P and Contact arrangement 7.								
Contact material		2 AgCdO 4 AgSnInO X Special Ag Alloy X (Cd Free)								
Coil voltage		Coil code: please refer to coil versions table								
Customer code		-99 Anti-explosion -00 WG version								

T92 Series Two-pole Power Relay (Continued)

Product Code	Enclosure	Contacts	Coil	Mounting	Contact Material	Coil	Part Number	
T92P7A22-24	Plastic dust cover	2 form A, 2 NO	AC	Panel mount + quick connect	AgCdO	24 VAC	6-1393211-0	
T92P7A22-120						120 VAC	5-1393211-7	
T92P7A22-240						240 VAC	6-1393211-2	
T92P7A22-277						277 VAC	6-1393211-3	
T92P7A24-240					AgSnOInO	240 VAC	3-1423008-3	
T92P7A52-120				Panel mount + screw terminals	AgCdO	120 VAC	1423008-8	
T92P7A52-240						240 VAC	1-1423008-2	
T92P7D12-12			DC	PCB terminals		12 VDC	6-1393211-5	
T92P7D12-24							24 VDC	6-1393211-6
T92P7D22-12				Panel mount + quick connect		12VDC	6-1393211-9	
T92P7D22-24						24 VDC	7-1393211-1	
T92P7D22-48						48 VDC	7-1393211-2	
T92P7D24-12					AgSnOInO	12VDC	2-1423008-2	
T92P7D24-24						24 VDC	1423008-9	
T92P7D42-24					AgCdO		7-1393211-5	
T92P7D52-12				Panel mount + screw terminals		12 VDC	1-1423008-0	
T92P7D52-24						24 VDC	1423967-1	
T92P11A12-120		2 form C, 2 CO	AC	PCB terminals		120 VAC	3-1393211-8	
T92P11A22-12				Panel mount + quick connect		12 VAC	3-1393211-9	
T92P11A22-24						24 VAC	4-1393211-3	
T92P11A22-120						120 VAC	4-1393211-0	
T92P11A22-240						240 VAC	4-1393211-4	
T92P11A22-277						277 VAC	4-1393211-6	
T92P11A24-240					AgSnOInO	240 VAC	3-1423008-7	
T92P11A42-120					AgCdO	120VAC	4-1393211-8	
T92P11D12-12			DC	PCB terminals		12 VDC	5-1393211-0	
T92P11D22-12					Panel mount + quick connect			5-1393211-3
T92P11D22-24						24 VDC	5-1393211-4	
T92P11D24-12					AgSnOInO	12 VDC	3-1423008-5	
T92P11D24-24						24 VDC	3-1423008-6	
T92S7A12-24	Wash tight	2 form A, 2 NO	AC	PCB terminals	AgCdO	24 VAC	9-1393211-8	
T92S7A12-120						120 VAC	9-1393211-7	
T92S7A12-240						240 VAC	9-1393211-9	
T92S7A22-24	Top sealed			Panel mount + quick connect		24 VAC	1393212-4	
T92S7A22-120						120 VAC	1393212-2	
T92S7A22-240						240 VAC	1393212-5	
T92S7D12-12	Wash tight		DC	PCB terminals		12 VDC	1393212-8	
T92S7D12-24							24 VDC	1-1393212-0
T92S7D12-48							48 VDC	1-1393212-1
T92S7D12-110						110 VDC	1393212-7	
T92S7D14-24					AgSnOInO	24 VDC	1-1423008-8	
T92S7D22-12	Top sealed			Panel mount + quick connect	AgCdO	12 VDC	1-1393212-4	
T92S7D22-18						18 VDC	1-1393212-5	
T92S7D22-24						24 VDC	1-1393212-7	
T92S7D22-110						110 VDC	1-1393212-3	
T92S11A12-24	Wash tight	2 form C, 2 CO	AC	PCB terminals		24 VAC	8-1393211-1	
T92S11A12-120						120 VAC	8-1393211-0	
T92S11A12-240						240 VAC	8-1393211-2	
T92S11A22-12	Top sealed			Panel mount + quick connect		12 VAC	8-1393211-3	
T92S11A22-24						24 VAC	8-1393211-6	
T92S11A22-120						120 VAC	8-1393211-4	
T92S11A22-240						240 VAC	8-1393211-7	
T92S11D12-12	Wash tight		DC	PCB terminals		12 VDC	8-1393211-9	
T92S11D12-24							24 VDC	9-1393211-0
T92S11D12-48							48 VDC	9-1393211-1
T92S11D12-110						110 VDC	8-1393211-8	
T92S11D22-12	Top sealed			Panel mount + quick connect		12 VDC	9-1393211-3	
T92S11D22-24						24 VDC	9-1393211-4	
T92S11D22-99						99 VDC	9-1393211-4	
T92S7D1X-12-99	Plastic dust cover	2 form A, 2 NO	DC	PCB terminals	AgCdO	12VDC	2-2071223-3	
T92S7D1X-12-99	Wash tight					Special Ag Alloy	12VDC	6-1423008-1
T92S7D2X-12-99				Panel mount + quick connect	X (Cd Free)	12VDC	6-1423008-2	
T92S7A22-240-00	Top Sealed(WG)		AC		AgCdO	240VAC	2-2071223-4	
T92S7D12-12-00	Wash tight (WG)		DC	PCB terminals		12VDC	1-2071223-7	

Note. This list represents the most common types and does not show all variants covered by this datasheet, other types on request.