

FEATURE

- 4A,650V, $R_{DS(ON)MAX}=2.6\ \Omega$ @ $V_{GS}=10V/2A$
- Low gate charge
- Low C_{iss}
- Fast switching
- 100% avalanche tested
- Improved dv/dt capability

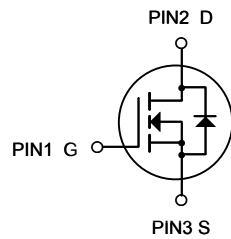

VOLTAGE RANGE

650Volts

CURRENT

4Amperes

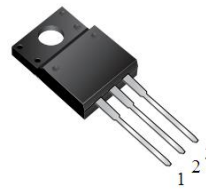

ITO-220AB
4N65F

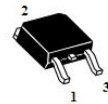

TO-252
4N65

MAXIMUM RATINGS AND ELECTRICAL CHARACTERISTICS

Rating 25°C ambient temperature unless otherwise specified.
Single phase half wave, 60Hz, resistive or inductive load.

Absolute Maximum Ratings ($T_c=25^\circ C$, unless otherwise noted)			
Parameter	Symbol	4N65	UNIT
Drain-Source Voltage	V_{DSS}	650	V
Gate-Source Voltage	V_{GSS}	± 30	
Continuous Drain Current	I_D	4	A
Pulsed Drain Current(Note 1)	I_{DM}	16	
Single Pulse Avalanche Energy (Note 2)	E_{AS}	150	mJ
Reverse Diode dV/dt (Note 3)	dv/dt	2.63	V/ns
Operating Junction and Storage Temperature Range	T_J, T_{STG}	-55 to +150	°C
Maximum lead temperature for soldering purposes, 1/8" from case for 5 seconds	T_L	260	°C
Mounting Torque	6-32 or M3 screw	10	lbf • in
		1.1	N • m

RATING AND CHARACTERISTIC CURVES (4N65)

Thermal Characteristics						
Parameter		Symbol	MAX	Units		
Maximum Junction-to-Case		R_{thJC}	3.47	°C/W		
Maximum Power Dissipation	$T_c=25^\circ\text{C}$	P_D	34	W		

Electrical Characteristics ($T_c=25^\circ\text{C}$, unless otherwise noted)						
Parameter	Symbol	Test Conditions	Min	Typ	Max	Units
Off Characteristics						
Drain-Source Breakdown Voltage	BV_{DSS}	$V_{GS}=0V, I_D=250\mu\text{A}$	650	—	—	V
Breakdown Temperature Coefficient	$\Delta BV_{DSS} / \Delta T_J$	Reference to 25°C , $I_D=250\mu\text{A}$	—	0.67	—	V/°C
Zero Gate Voltage Drain Current	I_{DSS}	$V_{DS}=650V, V_{GS}=0V$	—	—	10	μA
Gate-Body Leakage Current, Forward	I_{GSSF}	$V_{GS}=30V, V_{DS}=0V$	—	—	100	nA
Gate-Body Leakage Current, Reverse	I_{GSSR}	$V_{GS}=-30V, V_{DS}=0V$	—	—	-100	nA
On Characteristics						
Gate-Source Threshold Voltage	$V_{GS(th)}$	$V_{DS}=V_{GS}, I_D=250\mu\text{A}$	2	—	4	V
Drain-Source On-State Resistance	$R_{DS(on)}$	$V_{GS}=10V, I_D=2A$	—	2.1	2.6	Ω
Pulse width $t_p \leq 380\mu\text{s}$, $\delta \leq 2\%$						
Dynamic Characteristics						
Input Capacitance	C_{iss}	$V_{DS}=25V, V_{GS}=0V,$	—	425	—	pF
Output Capacitance	C_{oss}	$f=1.0\text{MHZ}$	—	55	—	pF
Reverse Transfer Capacitance	C_{rss}		—	5.8	—	pF
Switching Characteristics						
Turn-On Delay Time	$t_{d(on)}$	$V_{DD}=325V, I_D=4A,$	—	10	—	ns
Turn-On Rise Time	t_r	$R_G=10\Omega$	—	11	—	ns
Turn-Off Delay Time	$t_{d(off)}$	(Note3,4)	—	31	—	ns
Turn-Off Fall Time	t_f		—	16	—	ns
Total Gate Charge	Q_g	$V_{DS}=325V, I_D=4A,$	—	14.5	—	nC
Gate-Source Charge	Q_{gs}	$V_{GS}=10V$ (Note3,4)	—	3	—	nC
Gate-Drain Charge	Q_{gd}		—	6	—	nC
Drain-Source Body Diode Characteristics and Maximum Ratings						
Diode Forward Voltage	V_{SD}	$I_S=4A, V_{GS}=0V$	—	—	1.5	V
Reverse Recovery Time	t_{rr}	$V_{GS}=0V, I_S=4A, T_j=25^\circ\text{C}$	—	320	—	ns
Reverse Recovery Charge	Q_{rr}	$di_F/dt=100A/\mu\text{s}$ (Note3)	—	2.0	—	nC
Pulse width $t_p \leq 380\mu\text{s}$, $\delta \leq 2\%$						

Notes

1. Repetitive Rating: pulse width limited by maximum junction temperature .
2. $V_{DD}=50V$, starling, $L=18.8\text{mH}$, $R_g=25\Omega$, $I_{AS}=4A$, $T_j=25^\circ\text{C}$.
3. $di/dt= _A/\mu\text{s}$, starting $T_j=25^\circ\text{C}$. Pulse width $\leq 300\mu\text{s}$; duty cycle $\leq 2\%$.
4. Repetitive rating; pulse width limited by maximum junction temperature.

RATING AND CHARACTERISTIC CURVES (4N65)

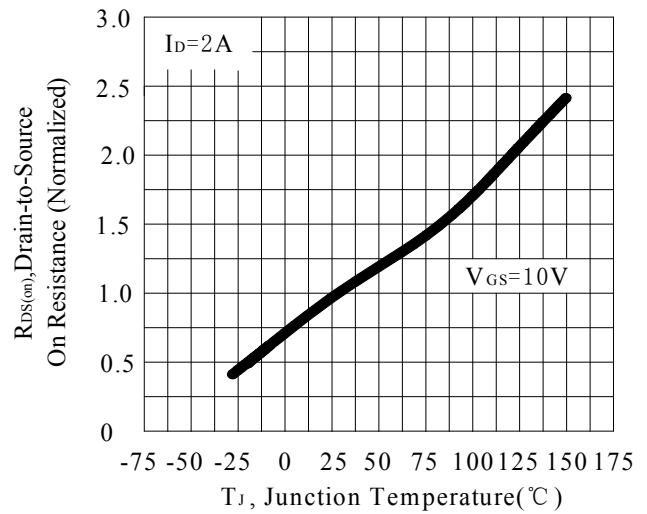
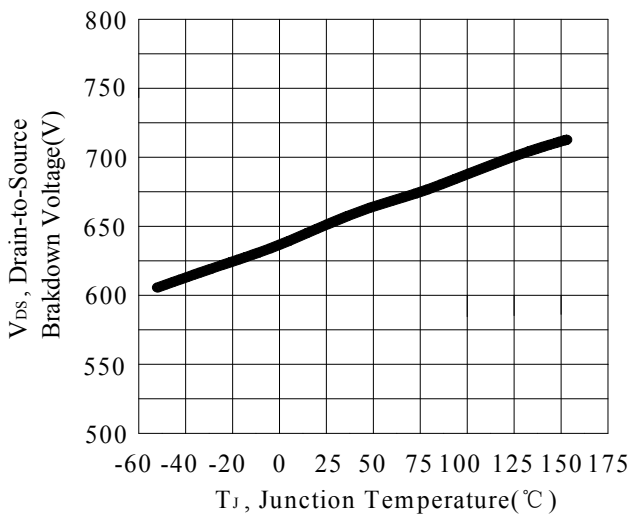
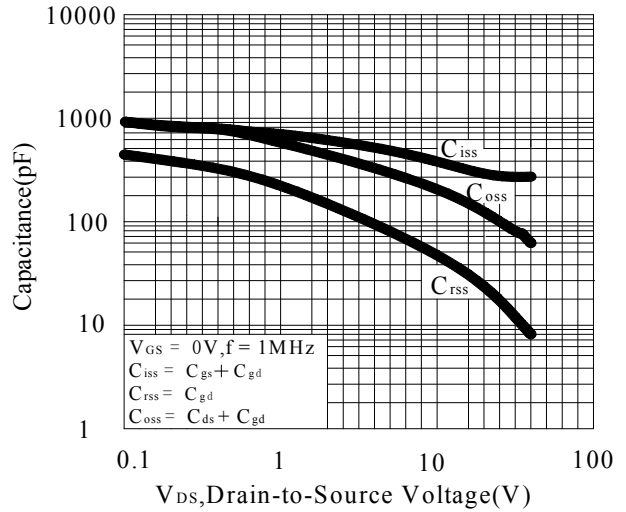
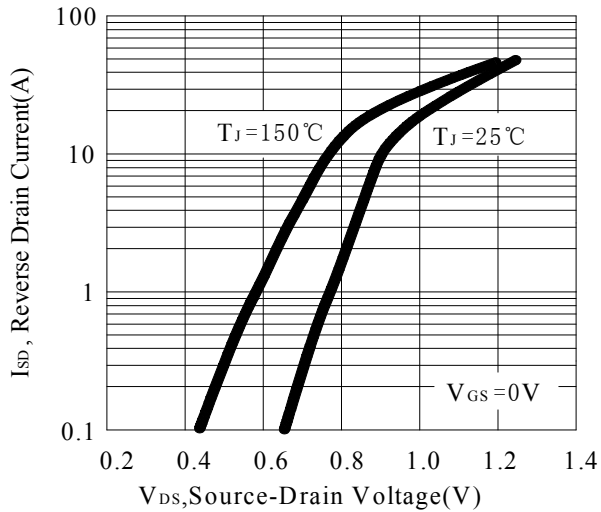
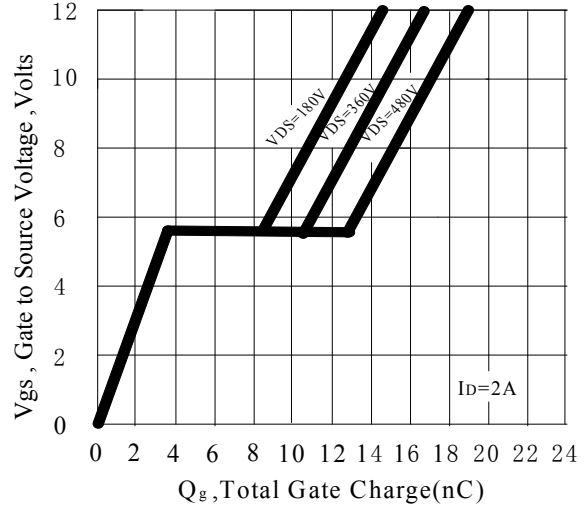
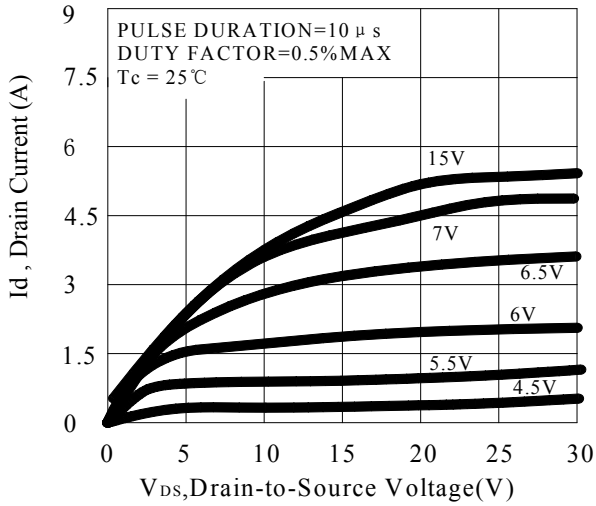

RATING AND CHARACTERISTIC CURVES (4N65)

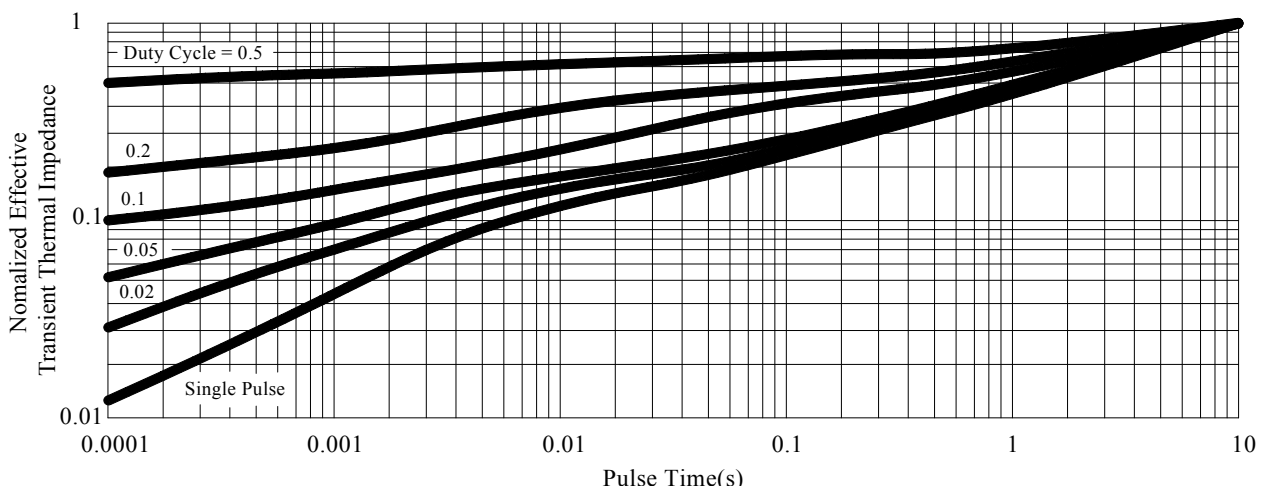
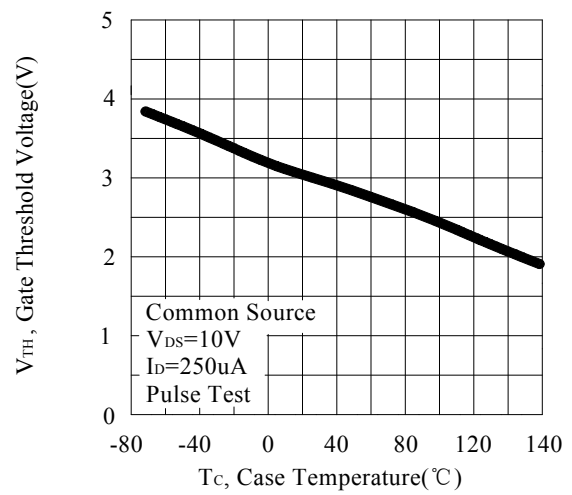
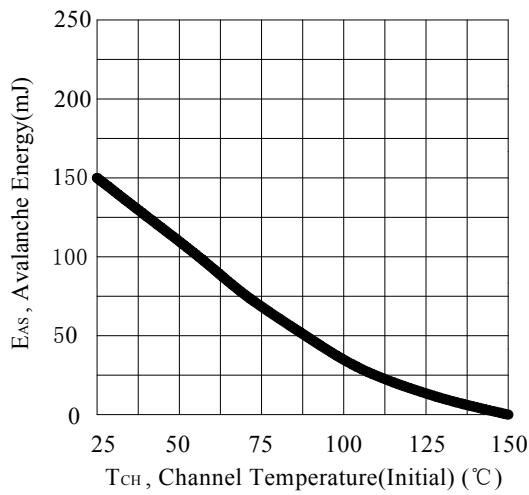
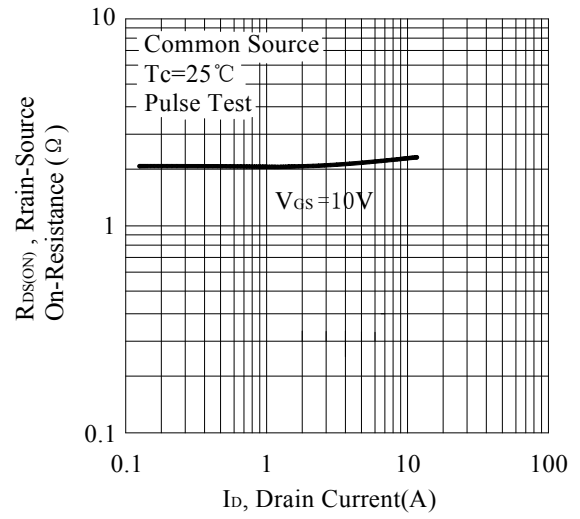
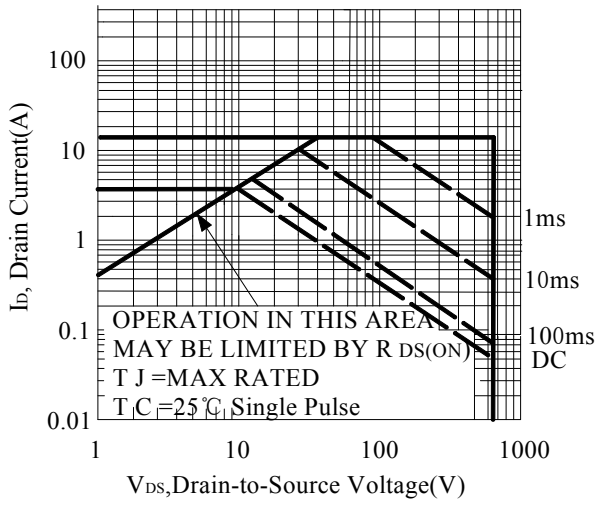

RATING AND CHARACTERISTIC CURVES (4N65)

ITO-220 Mechanical Drawing

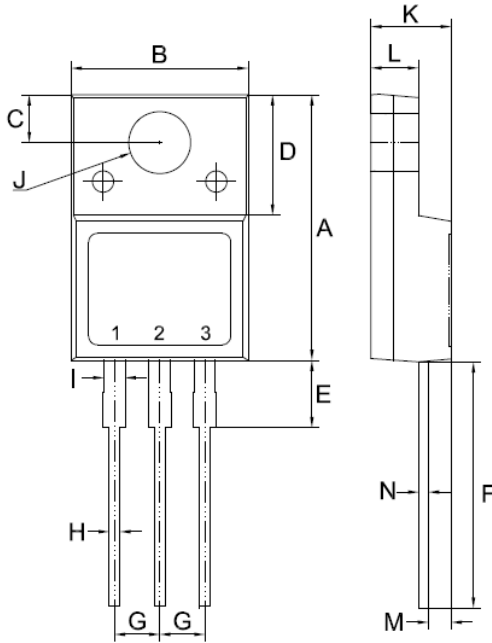

ITO-220AB		
Unit:mm		
DIM	MIN	MAX
A	14.50	15.50
B	9.50	10.50
C	2.50	2.90
D	6.30	7.30
E	3.30	4.30
F	13.00	14.00
G	2.35	2.75
H	0.30	0.90
I	0.90	1.50
J	3.20	3.80
K	4.24	4.84
L	2.52	2.92
M	1.09	1.49
N	0.47	0.64

TO-252 Mechanical Drawing

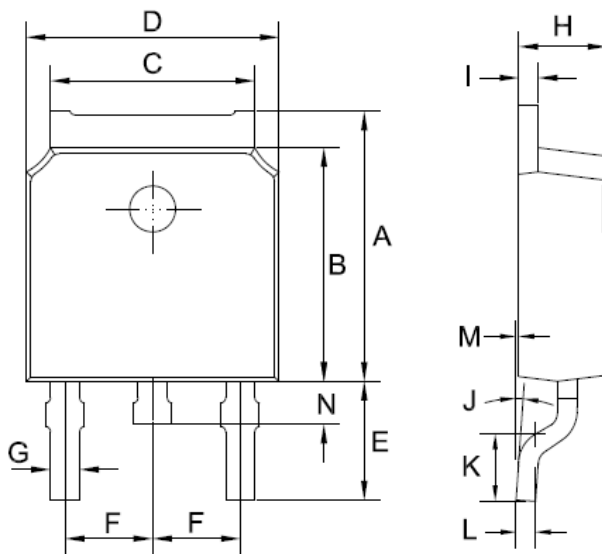

TO-252 (DPAK)		
Unit:mm		
DIM	MIN	MAX
A	6.85	7.25
B	5.90	6.30
C	5.13	5.53
D	6.40	6.80
E	2.90	3.30
F	2.19	2.39
G	0.45	0.85
H	2.20	2.40
I	0.41	0.61
J	0°	8°
K	1.45	1.85
L	0.41	0.61
M	0.00	0.12
N	0.60	1.00