

# Aluminum electrolytic capacitors

## Capacitors with screw terminals

**Series/Type:** B43456, B43458

**Date:** November 2012

© EPCOS AG 2015. Reproduction, publication and dissemination of this publication, enclosures hereto and the information contained therein without EPCOS' prior express consent is prohibited.

EPCOS AG is a TDK Group Company.

### Long-life grade capacitors

#### Applications

- Frequency converters
- Wind power converters
- Solar inverters
- Professional power supplies
- Uninterruptible power supplies

#### Features

- High CV product, i.e. extremely compact
- High reliability and high ripple current capability
- All-welded constructions ensures reliable electrical contact
- PAPR terminals available (Protection Against Polarity Reversal)
- Version with optimized construction for base cooling (heat sink mounting) available
- Version with low-inductance design available
- RoHS-compatible

#### Construction

- Charge-discharge proof, polar
- Aluminum case with insulating sleeve
- Poles with screw terminal connections
- Mounting with ring clips, clamps or threaded stud
- The bases of types with threaded stud and  $d \leq 76.9$  mm are not insulated, types with  $d = 91$  mm have fully insulated bases

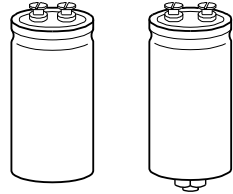
**B43456**
**B43458**



### Specifications and characteristics in brief

Rated voltage $V_R$	350 ... 550 V DC				
Surge voltage $V_S$	$1.10 \cdot V_R$				
Rated capacitance $C_R$	560 ... 18000 $\mu\text{F}$				
Capacitance tolerance	$\pm 20\% \triangle M$				
Dissipation factor $\tan \delta$ (20 °C, 120 Hz)	$\leq 0.20$				
Leakage current $I_{\text{leak}}$ (20 °C, 5 min)	$I_{\text{leak}} \leq 0.020 \mu\text{A} \cdot \left( \frac{C_R}{\mu\text{F}} \cdot \frac{V_R}{\text{V}} \right)^{0.85} + 4 \mu\text{A}$				
Self-inductance ESL	d = 51.6 mm: approx. 15 nH d $\geq$ 64.3 mm: approx. 20 nH Capacitors with low-inductance design: d $\geq$ 64.3 mm: approx. 13 nH				
Useful life <sup>1)</sup> 85 °C; $V_R$ ; $I_{\text{AC,R}}$ 40 °C; $V_R$ ; $1.5 \cdot I_{\text{AC,R}}$	350 ... 450 V	500 ... 550 V	Requirements:		
	> 12000 h	> 8000 h	$\Delta C/C \leq \pm 15\%$ of initial value		
	> 250000 h	> 250000 h	$\tan \delta \leq 1.75$ times initial specified limit		
			$I_{\text{leak}} \leq$ initial specified limit		
Voltage endurance test 85 °C; $V_R$	2000 h	Post test requirements:			
		$\Delta C/C \leq \pm 10\%$ of initial value	$\tan \delta \leq 1.3$ times initial specified limit		
		$I_{\text{leak}} \leq$ initial specified limit			
Vibration resistance test	To IEC 60068-2-6, test Fc: Frequency range 10 ... 55 Hz, displacement amplitude 0.75 mm, acceleration max. 10 g, duration $3 \times 2$ h. Capacitor mounted by its body which is rigidly clamped to the work surface.				
Characteristics at low temperature	Max. impedance ratio at 100 Hz	$V_R$	$\leq 400$ V	$\geq 450$ V	500 ... 550 V
		$Z_{-25^\circ\text{C}} / Z_{20^\circ\text{C}}$	3	4	3
		$Z_{-40^\circ\text{C}} / Z_{20^\circ\text{C}}$	7	9	10
IEC climatic category	To IEC 60068-1: 40/085/56 (–40 °C/+85 °C/56 days damp heat test)				
Detail specification	Similar to CECC 30301-803, CECC 30301-807				
Sectional specification	IEC 60384-4				

### Ripple current capability

Due to the ripple current capability of the contact elements, the following current upper limits must not be exceeded:

Capacitor diameter	51.6 mm	64.3 mm	76.9 mm	91 mm
$I_{\text{AC,max}}$	34 A	45 A	57 A	80 A

1) Refer to chapter "General technical information, 5 Useful life" on how to interpret useful life.



**B43456, B43458**

**Extremely compact – 85 °C**

**Dimensional drawings**

**B43456**

Ring clip/clamp mounting

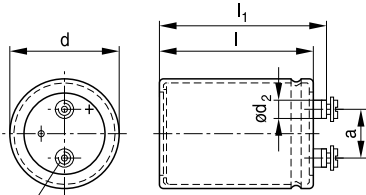

KAL1318-B-E

**B43458**

Threaded stud mounting

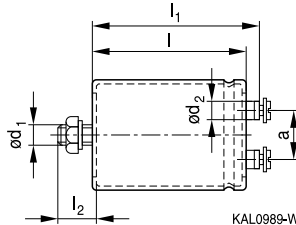

KAL0989-W

- M5: Min. reach of screw = 9.5 mm  
9 mm for low inductance design
- M6: Min. reach of screw = 12 mm  
9.5 mm for low inductance design

Positive pole marking: +

The base of types with threaded stud and  $d = 91$  mm is fully insulated (the lengths  $l$  and  $l_1$  are increased by 0.5 mm in these cases). For types with threaded stud and  $d \leq 76$  mm the base is not insulated. Also refer to the mounting instructions in chapter "Capacitors with screw terminals – Accessories".

Screw terminals with UNF threads are available upon request.

**Dimensions and weights**

Ter- minal	Dimensions (mm) with insulating sleeve							Approx. weight (g)
	d	$l \pm 1$	$l_1 \pm 1$	$l_2 +0/-1$	$d_1$	$d_2$ max.	$a +0.2/-0.4$	
M5	51.6 +0/-0.8	80.7	87.2	17	M12	10.2	22.2	220
M5	51.6 +0/-0.8	105.7	112.2	17	M12	10.2	22.2	280
M5	51.6 +0/-0.8	118.2	124.7	17	M12	10.2	22.2	320
M5	51.6 +0/-0.8	130.7	137.2	17	M12	10.2	22.2	350
M5	64.3 +0/-0.8	80.7	87.2	17	M12	13.2	28.5	370
M5	64.3 +0/-0.8	96.7	103.2	17	M12	13.2	28.5	400
M5	64.3 +0/-0.8	105.7	112.2	17	M12	13.2	28.5	440
M5	64.3 +0/-0.8	118.2	124.7	17	M12	13.2	28.5	510
M5	64.3 +0/-0.8	130.7	137.2	17	M12	13.2	28.5	600
M5	64.3 +0/-0.8	143.2	149.7	17	M12	13.2	28.5	630
M6	76.9 +0/-0.7	105.7	111.5	17	M12	17.7	31.7	620
M6	76.9 +0/-0.7	118.2	124.0	17	M12	17.7	31.7	700
M6	76.9 +0/-0.7	130.7	136.5	17	M12	17.7	31.7	800
M6	76.9 +0/-0.7	143.2	149.0	17	M12	17.7	31.7	840
M6	76.9 +0/-0.7	168.7	174.5	17	M12	17.7	31.7	1000
M6	76.9 +0/-0.7	190.7	196.5	17	M12	17.7	31.7	1150
M6	76.9 +0/-0.7	220.7	226.5	17	M12	17.7	31.7	1300



Terminal	Dimensions (mm) with insulating sleeve							Approx. weight (g)
	d	l ±1	l <sub>1</sub> ±1	l <sub>2</sub> +0/-1	d <sub>1</sub>	d <sub>2</sub> max.	a +0.2/-0.4	
M6	91.0 +0/-2	97.0	102.3	17	M12	17.7	31.7	770
M6	91.0 +0/-2	144.5	149.8	17	M12	17.7	31.7	1200
M6	91.0 +0/-2	170.0	175.3	17	M12	17.7	31.7	1400
M6	91.0 +0/-2	221.0	226.3	17	M12	17.7	31.7	1900

For low-inductance design the following deviation applies:

d = 64.3 mm: l<sub>1</sub> -0.7 mm

d = 91.0 mm: l<sub>1</sub> -1.7 mm

### Packing

Capacitor diameter d (mm)	length l (mm)	Packing units (pcs.)
51.6	all	36
64.3	all	25

Capacitor diameter d (mm)	length l (mm)	Packing units (pcs.)
76.9	105.7 - 168.7	16
	191.0 - 220.7	12
91.0	all	9



For ecological reasons the packing is pure cardboard.



**B43456, B43458**

**Extremely compact – 85 °C**

### Special designs

- Low-inductance design
- PAPER terminal style

With our PAPER terminal style (**P**rotection **A**gainst **P**olarity **R**eversal) we offer an optional mechanical feature in addition to the visual polarity marking on the cover disk and the sleeve, which prevents from mounting in reverse polarity. The non-circular shape of the terminals and their arrangement perpendicular to each other enables the user to definitely prevent wrong mounting with respect to polarity (Poka Yoke).

Dimensional drawing of PAPER terminal configuration

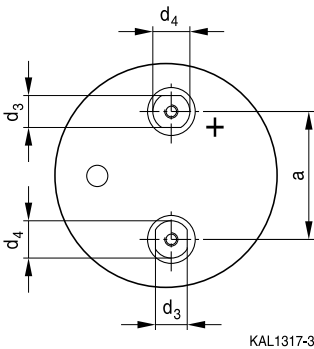

Dimensions for PAPER terminal style (mm)

Can diameter d	Terminal	$d_3 \pm 0.1$	$d_4 \pm 0.1$	a +0.2/-0.4	Min. reach of screw	
					Standard design #050	For heat sink mounting #057
51.6	M5	10	13	22.2	9.5	–
64.3	M5	13	15	28.5	9.5	7.3
76.9	M6	13	15	31.7	12.0	9.7
91.0	M6	13	15	31.7	12.0	9.7

All other dimensions of the capacitor such as diameter d, case length l and overall length  $l_1$  are identical with those of standard capacitors of this series. Please refer to the tables “Dimensions and weights” (standard types) and “Dimensions and weights for heat sink mounting” (special designs).

- For heat sink mounting

Design for optimal connection of capacitors to the heat sink when using base cooling with the following features (refer to chapter “General technical information, 5.2 Cooling”):

- Electrical insulation of the capacitors base with 2 overlapping thermal pads for optimal heat flow (minimal thermal resistance at the capacitor base)



- Minimal overall length tolerance ( $\pm 0.35$  mm) for mounting between heat sink and bus bar
- Case with extra groove near the base for clamp mounting (recommended ring clamp B44030A0165B ... A0190B)

This version is available only for capacitors without threaded stud and for diameters  $\geq 64.3$  mm.

Regarding ripple current and useful life, please refer to column  $I_{AC,R}(B)$  in the table "Technical data and ordering codes" and in the useful life curves.

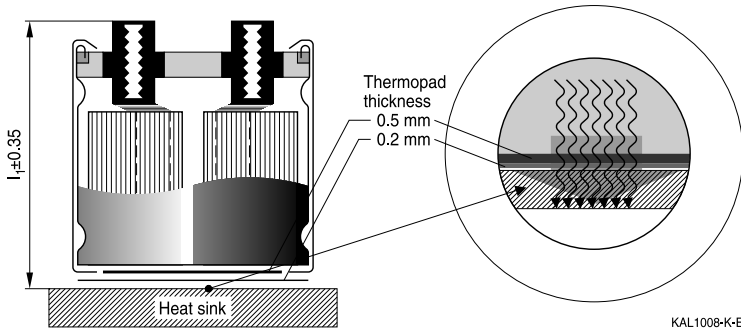

KAL1008-K-E

Dimensions and weights for heat sink mounting:

Terminal	Dimensions (mm) with insulating sleeve					Min. reach of screw mm	Approx. weight g
	d	$l \pm 1$	$l_1 \pm 0.35$	$d_2$ max.	$a + 0.2/-0.4$		
M5	64.3 +0/-0.8	80.7	86.3	13.2	28.5	7.3	370
M5	64.3 +0/-0.8	105.7	111.3	13.2	28.5	7.3	440
M6	76.9 +0/-0.7	105.7	110.6	17.7	31.7	9.7	620
M6	76.9 +0/-0.7	143.2	148.1	17.7	31.7	9.7	840
M6	91.0 +0/-2	97.0	101.4	17.7	31.7	9.7	1000
M6	91.0 +0/-2	144.5	148.9	17.7	31.7	9.7	1200

Dimensions for other sizes are available upon request.

Ordering codes:

Design	Identification in third block of ordering code	Remark
Low inductance (13 nH)	M003	For capacitors with diameter $d \geq 64.3$ mm
For heat sink mounting	M007	For capacitors with diameter $d \geq 64.3$ mm and without threaded stud
PAPR terminal style	M050	Not for low inductance
PAPR terminal style and heat sink mounting	M057	For capacitors with diameter $d \geq 64.3$ mm and without threaded stud; not for low inductance

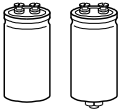

**B43456, B43458**

**Extremely compact – 85 °C**

### Accessories

The following items are included in the delivery package, but are not fastened to the capacitors:

	Thread	Toothed washers	Screws/nuts	Maximum torque
For terminals	M5	A 5.1 DIN 6797	DIN 7985 / ISO 7045-M5 × 10-5.6-Z	2.5 Nm thread depth t ≥ 8 mm
	M6	A 6.4 DIN 6797	DIN 7985 / ISO 7045-M6 × 12-5.6-Z	4.0 Nm thread depth t ≥ 9.5 mm
For mounting	M12	J 12.5 DIN 6797	Hex nut BM 12 DIN 439	10 Nm

The following items must be ordered separately. For details, refer to chapter "Capacitors with screw terminals – Accessories".

Item	Type
Ring clips	B44030
Clamps for capacitors with $d \geq 64.3$ mm	B44030
Insulating parts	B44020



**Overview of available types**

$V_R$ (V DC)	350	400	450	500	550
	Case dimensions $d \times l$ (mm)				
$C_R$ ( $\mu$ F)					
560					51.6 × 80.7
680					51.6 × 105.7
820				51.6 × 80.7	51.6 × 105.7
1000		51.6 × 80.7	51.6 × 80.7	51.6 × 105.7	51.6 × 118.2 64.3 × 80.7
1200				51.6 × 105.7 64.3 × 80.7	51.6 × 130.7 64.3 × 105.7
1500	51.6 × 80.7	51.6 × 80.7	51.6 × 105.7	51.6 × 130.7 64.3 × 96.7	64.3 × 118.2
1800				64.3 × 105.7	64.3 × 130.7 76.9 × 105.7
2200	51.6 × 105.7	51.6 × 105.7	64.3 × 105.7	64.3 × 118.2 76.9 × 105.7	64.3 × 143.2 76.9 × 118.2 91.0 × 97.0
2700		51.6 × 130.7	64.3 × 105.7	64.3 × 143.2 76.9 × 105.7	76.9 × 130.7
3300	51.6 × 118.2	64.3 × 105.7	76.9 × 105.7	76.9 × 130.7	76.9 × 143.2
3900	64.3 × 105.7			76.9 × 143.2	
4700	64.3 × 105.7	64.3 × 130.7 76.9 × 105.7	64.3 × 143.2 76.9 × 118.2	76.9 × 168.7	
5600	76.9 × 105.7	76.9 × 118.2	76.9 × 143.2		
6800	76.9 × 118.2	76.9 × 143.2	76.9 × 168.7 91.0 × 144.5		
8200	76.9 × 143.2	76.9 × 168.7	76.9 × 220.7		
10000	76.9 × 143.2	76.9 × 190.7 91.0 × 144.5	76.9 × 220.7 91.0 × 170.0		
12000	91.0 × 144.5	76.9 × 220.7	91.0 × 221.0		
15000	76.9 × 220.7	91.0 × 221.0			
18000	91.0 × 221.0				

The capacitance and voltage ratings listed above are available in different cases upon request.

Other voltage and capacitance ratings are also available upon request.



**B43456, B43458**

**Extremely compact – 85 °C**

**Technical data and ordering codes**

$C_R$	Case dimensions	$ESR_{typ}$	$Z_{max}$	$I_{AC,max}$	$I_{AC,R}$	$I_{AC,R(B)}$	Ordering code (composition see below)
100 Hz	$d \times l$	100 Hz	10 kHz	100 Hz	100 Hz	100 Hz	
20 °C	mm	20 °C	20 °C	40 °C	85 °C	85 °C	
$\mu F$		m $\Omega$	m $\Omega$	A	A	A	

$V_R = 350$  V DC

1500	51.6 × 80.7	47	50	16	5.7	11	B4345*A4158M0##
2200	51.6 × 105.7	28	31	21	7.6	14	B4345*A4228M0##
3300	51.6 × 118.2	20	24	28	10	17	B4345*A4338M0##
3900	64.3 × 105.7	17	20	32	12	21	B4345*A4398M0##
4700	64.3 × 105.7	15	18	35	13	24	B4345*A4478M0##
5600	76.9 × 105.7	14	17	43	15	30	B4345*A4568M0##
6800	76.9 × 118.2	12	14	47	17	31	B4345*A4688M0##
8200	76.9 × 143.2	11	12	57	20	36	B4345*A4828M0##
10000	76.9 × 143.2	7	8	57	23	40	B4345*A4109M0##
12000	91.0 × 144.5	6	7	77	28	53	B4345*A4129M0##
15000	76.9 × 220.7	8	9	57	34	51	B4345*A4159M0##
18000	91.0 × 221.0	5	7	80	38	60	B4345*A4189M0##

$V_R = 400$  V DC

1000	51.6 × 80.7	60	66	13	4.6	8.2	B4345*A9108M0##
1500	51.6 × 80.7	45	46	17	6.0	13	B4345*A9158M0##
2200	51.6 × 105.7	30	30	22	8.0	15	B4345*A9228M0##
2700	51.6 × 130.7	26	30	26	9.3	15	B4345*A9278M0##
3300	64.3 × 105.7	23	24	31	11	20	B4345*A9338M0##
4700	64.3 × 130.7	16	18	38	14	23	B4345*B9478M0##
4700	76.9 × 105.7	16	17	40	14	29	B4345*A9478M0##
5600	76.9 × 118.2	14	15	44	16	29	B4345*A9568M0##

**Composition of ordering code**

\* = Mounting style

- 6 = for capacitors with ring clip/clamp mounting
- 8 = for capacitors with threaded stud

## = Design

- 00 = for capacitors with standard inductance
- 03 = for capacitors with low inductance (13 nH)  
(only for capacitors with diameter  $d \geq 64.3$  mm)
- 07 = for heat sink mounting (only for capacitors with diameter  $d \geq 64.3$  mm and without threaded stud)
- 50 = for terminals with PAPR style (not for low-inductance)
- 57 = for terminals with PAPR style and heat sink mounting (only  $d \geq 64.3$  mm and without threaded stud, not for low inductance)

**Technical data and ordering codes**

$C_R$ 100 Hz 20 °C $\mu\text{F}$	Case dimensions $d \times l$ mm	$\text{ESR}_{\text{typ}}$ 100 Hz 20 °C $\text{m}\Omega$	$Z_{\text{max}}$ 10 kHz 20 °C $\text{m}\Omega$	$I_{\text{AC,max}}$ 100 Hz 40 °C A	$I_{\text{AC,R}}$ 100 Hz 85 °C A	$I_{\text{AC,R(B)}}$ 100 Hz 85 °C A	Ordering code (composition see below)
<b><math>V_R = 400 \text{ V DC}</math></b>							
6800	76.9 × 143.2	11	14	53	19	33	B4345*A9688M0##
8200	76.9 × 168.7	10	11	57	21	34	B4345*A9828M0##
10000	76.9 × 190.7	7	8	57	25	38	B4345*B9109M0##
10000	91.0 × 144.5	6	7	71	25	49	B4345*A9109M0##
12000	76.9 × 220.7	8	9	57	31	46	B4345*A9129M0##
15000	91.0 × 221.0	6	11	80	35	57	B4345*A9159M0##
<b><math>V_R = 450 \text{ V DC}</math></b>							
1000	51.6 × 80.7	120	150	13	4.8	9.6	B4345*A5108M0##
1500	51.6 × 105.7	80	105	18	6.5	12	B4345*A5158M0##
2200	64.3 × 105.7	50	60	24	8.4	15	B4345*A5228M0##
2700	64.3 × 105.7	42	50	26	9.4	17	B4345*A5278M0##
3300	76.9 × 105.7	35	40	32	12	23	B4345*A5338M0##
4700	64.3 × 143.2	25	30	40	14	24	B4345*A5478M0##
4700	76.9 × 118.2	25	30	40	15	27	B4345*B5478M0##
5600	76.9 × 143.2	23	31	49	17	31	B4345*A5568M0##
6800	76.9 × 168.7	18	21	54	19	31	B4345*B5688M0##
6800	91.0 × 144.5	17	22	57	20	38	B4345*A5688M0##
8200	76.9 × 220.7	15	20	57	24	36	B4345*A5828M0##
10000	76.9 × 220.7	13	15	57	27	40	B4345*A5109M0##
10000	91.0 × 170.0	12	14	74	26	46	B4345*B5109M0##
12000	91.0 × 221.0	9	12	80	32	53	B4345*A5129M0##

**Composition of ordering code**

\* = Mounting style

- 6 = for capacitors with ring clip/clamp mounting
- 8 = for capacitors with threaded stud

## = Design

- 00 = for capacitors with standard inductance
- 03 = for capacitors with low inductance (13 nH)  
(only for capacitors with diameter  $d \geq 64.3$  mm)
- 07 = for heat sink mounting (only for capacitors with diameter  $d \geq 64.3$  mm and without threaded stud)
- 50 = for terminals with PAPR style (not for low-inductance)
- 57 = for terminals with PAPR style and heat sink mounting (only  $d \geq 64.3$  mm and without threaded stud, not for low inductance)



**B43456, B43458**

**Extremely compact – 85 °C**

**Technical data and ordering codes**

$C_R$ 100 Hz 20 °C $\mu\text{F}$	Case dimensions $d \times l$ mm	$ESR_{\text{typ}}$ 100 Hz 20 °C $\text{m}\Omega$	$Z_{\text{max}}$ 10 kHz 20 °C $\text{m}\Omega$	$I_{\text{AC,max}}$ 100 Hz 40 °C A	$I_{\text{AC,R}}$ 100 Hz 85 °C A	$I_{\text{AC,R(B)}}$ 100 Hz 85 °C A	Ordering code (composition see below)
<b><math>V_R = 500 \text{ V DC}</math></b>							
820	51.6 × 80.7	130	163	11	3.9	7.6	B4345*A6827M0##
1000	51.6 × 105.7	105	131	13	4.5	7.5	B4345*A6108M0##
1200	51.6 × 105.7	85	106	15	5.3	9.2	B4345*A6128M0##
1200	64.3 × 80.7	85	106	15	5.2	9.8	B4345*B6128M0##
1500	51.6 × 130.7	73	91	17	6.0	9.3	B4345*A6158M0##
1500	64.3 × 96.7	73	91	16	5.9	10.3	B4345*B6158M0##
1800	64.3 × 105.7	57	71	20	7.0	12.1	B4345*A6188M0##
2200	64.3 × 118.2	45	56	23	8.3	13.9	B4345*A6228M0##
2200	76.9 × 105.7	45	56	23	8.4	14.9	B4345*B6228M0##
2700	64.3 × 143.2	38	48	27	9.6	14.8	B4345*A6278M0##
2700	76.9 × 105.7	38	48	27	9.5	18.1	B4345*B6278M0##
3300	76.9 × 130.7	35	44	29	10.4	17.7	B4345*A6338M0##
3900	76.9 × 143.2	28	35	34	12.2	20.3	B4345*A6398M0##
4700	76.9 × 168.7	25	31	38.0	13.6	21.1	B4345*A6478M0##
<b><math>V_R = 550 \text{ V DC}</math></b>							
560	51.6 × 80.7	175	219	9	3.2	5.8	B4345*A7567M0##
680	51.6 × 105.7	145	181	10	3.7	5.7	B4345*A7687M0##
820	51.6 × 105.7	121	151	12	4.2	6.9	B4345*A7827M0##
1000	51.6 × 118.2	100	125	14	4.9	7.8	B4345*A7108M0##
1000	64.3 × 80.7	100	125	13	4.8	9.0	B4345*B7108M0##
1200	51.6 × 130.7	83	104	16	5.6	9.1	B4345*A7128M0##

**Composition of ordering code**

\* = Mounting style

- 6 = for capacitors with ring clip/clamp mounting
- 8 = for capacitors with threaded stud

## = Design

- 00 = for capacitors with standard inductance
- 03 = for capacitors with low inductance (13 nH)  
(only for capacitors with diameter  $d \geq 64.3$  mm)
- 07 = for heat sink mounting (only for capacitors with diameter  $d \geq 64.3$  mm and without threaded stud)
- 50 = for terminals with PAPR style (not for low-inductance)
- 57 = for terminals with PAPR style and heat sink mounting (only  $d \geq 64.3$  mm and without threaded stud, not for low inductance)

**Technical data and ordering codes**

$C_R$	Case dimensions	$ESR_{typ}$	$Z_{max}$	$I_{AC,max}$	$I_{AC,R}$	$I_{AC,R(B)}$	Ordering code (composition see below)
100 Hz	$d \times l$	100 Hz	10 kHz	100 Hz	100 Hz	100 Hz	
20 °C	mm	20 °C	20 °C	40 °C	85 °C	85 °C	
$\mu F$		$m\Omega$	$m\Omega$	A	A	A	
<b><math>V_R = 550</math> V DC</b>							
1200	64.3 × 105.7	83	104	15	5.4	8.8	B4345*B7128M0##
1500	64.3 × 118.2	72	90	17	6.2	9.8	B4345*A7158M0##
1800	64.3 × 130.7	60	75	20	7.0	11.0	B4345*A7188M0##
1800	76.9 × 105.7	60	75	20	7.2	12.7	B4345*B7188M0##
2200	64.3 × 143.2	49	61	23	8.2	12.7	B4345*A7228M0##
2200	76.9 × 118.2	49	61	23	8.1	12.7	B4345*B7228M0##
2200	91.0 × 97.0	48	60	25	8.8	17.0	B4345*C7228M0##
2700	76.9 × 130.7	46	58	25	8.9	15.1	B4345*A7278M0##
3300	76.9 × 143.2	37	46	29	10.5	17.4	B4345*A7338M0##

**Composition of ordering code**

\* = Mounting style

- 6 = for capacitors with ring clip/clamp mounting
- 8 = for capacitors with threaded stud

## = Design

- 00 = for capacitors with standard inductance
- 03 = for capacitors with low inductance (13 nH)  
(only for capacitors with diameter  $d \geq 64.3$  mm)
- 07 = for heat sink mounting (only for capacitors with diameter  $d \geq 64.3$  mm and without threaded stud)
- 50 = for terminals with PAPR style (not for low-inductance)
- 57 = for terminals with PAPR style and heat sink mounting (only  $d \geq 64.3$  mm and without threaded stud, not for low inductance)

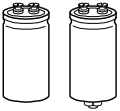

**B43456, B43458**

**Extremely compact – 85 °C**

**Useful life<sup>1)</sup>**

depending on ambient temperature  $T_A$  (for natural cooling) and versus temperature of case base  $T_B$  (for base cooling) under ripple current operating conditions at  $V_R \leq 450 \text{ V}^{2)}$

$V_R = 350 \dots 450 \text{ V}$ :

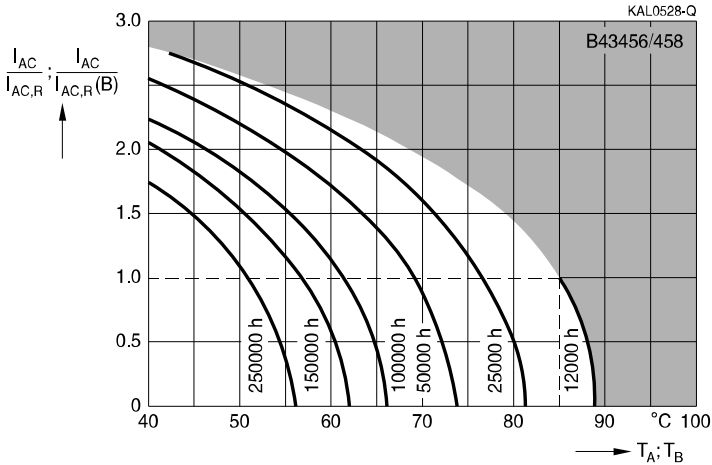

**Useful life<sup>1)</sup>**

depending on ambient temperature  $T_A$  (for natural cooling) and versus temperature of case base  $T_B$  (for base cooling) under ripple current operating conditions at  $V_R \geq 500 \text{ V}^{2)}$

$V_R \geq 500 \text{ V}$ :

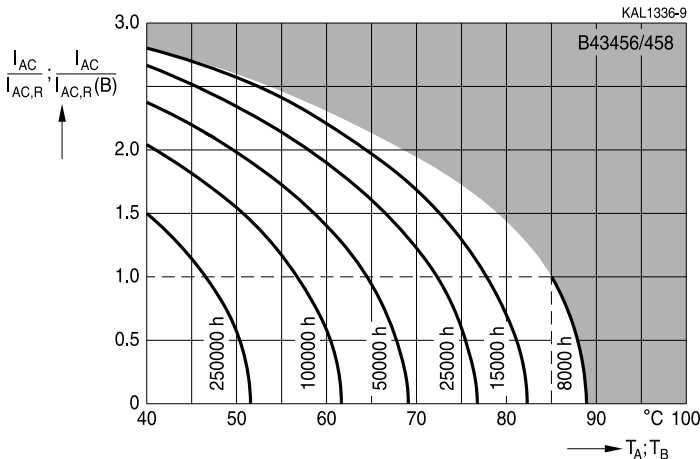

- 1) Refer to chapter "General technical information, 5 Useful life" on how to interpret useful life.
- 2) The ripple current refers to  $I_{AC,R}$  for natural cooling or  $I_{AC,R(B)}$  for base cooling, respectively.



**Frequency factor of permissible ripple current  $I_{AC}$  versus frequency  $f$**

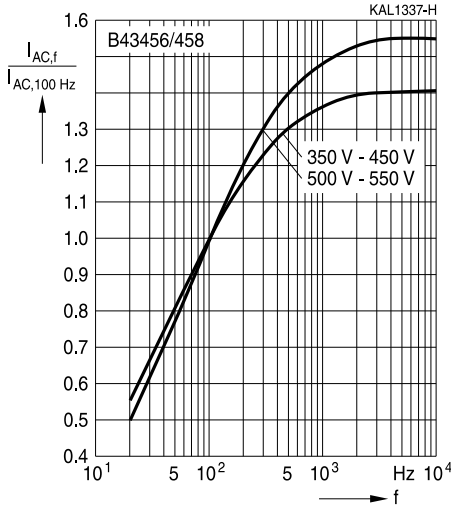

**Frequency characteristics of ESR**

Typical behavior

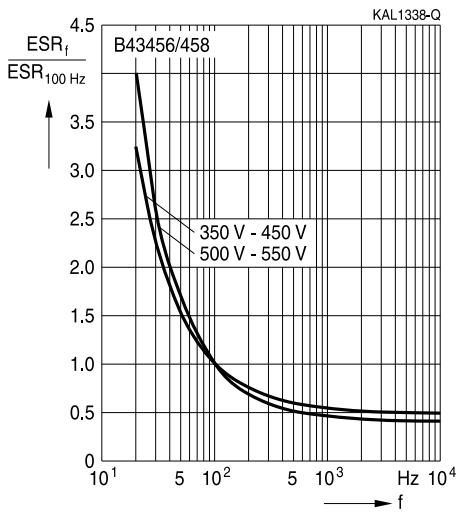

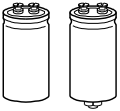

**B43456, B43458**

**Extremely compact – 85 °C**

**Impedance Z versus frequency f**

Typical behavior at 20 °C

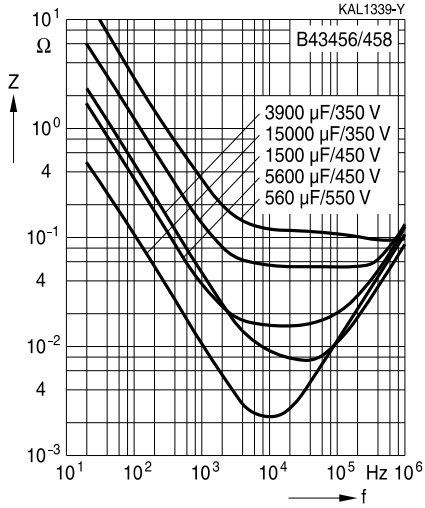





## Cautions and warnings

### Personal safety

The electrolytes used by EPCOS have been optimized both with a view to the intended application and with regard to health and environmental compatibility. They do not contain any solvents that are detrimental to health, e.g. dimethyl formamide (DMF) or dimethyl acetamide (DMAC).

Furthermore, some of the high-voltage electrolytes used by EPCOS are self-extinguishing.

As far as possible, EPCOS does not use any dangerous chemicals or compounds to produce operating electrolytes. However, in exceptional cases, such materials must be used in order to achieve specific physical and electrical properties because no alternative materials are currently known. However, the amount of dangerous materials used in our products is limited to an absolute minimum.

Materials and chemicals used in EPCOS aluminum electrolytic capacitors are continuously adapted in compliance with the EPCOS Corporate Environmental Policy and the latest EU regulations and guidelines such as RoHS, REACH/SVHC, GADSL, and ELV.

MDS (Material Data Sheets) are available on the EPCOS website for all types listed in the data book. MDS for customer specific capacitors are available upon request.

MSDS (Material Safety Data Sheets) are available for all of our electrolytes upon request.

Nevertheless, the following rules should be observed when handling aluminum electrolytic capacitors: No electrolyte should come into contact with eyes or skin. If electrolyte does come into contact with the skin, wash the affected areas immediately with running water. If the eyes are affected, rinse them for 10 minutes with plenty of water. If symptoms persist, seek medical treatment. Avoid inhaling electrolyte vapor or mists. Workplaces and other affected areas should be well ventilated. Clothing that has been contaminated by electrolyte must be changed and rinsed in water.

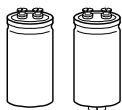

**B43456, B43458**

**Extremely compact – 85 °C**

## Product safety

The table below summarizes the safety instructions that must be observed without fail. A detailed description can be found in the relevant sections of chapter "General technical information".

Topic	Safety information	Reference chapter "General technical information"
Polarity	Make sure that polar capacitors are connected with the right polarity.	1 "Basic construction of aluminum electrolytic capacitors"
Reverse voltage	Voltages polarity classes should be prevented by connecting a diode.	3.1.6 "Reverse voltage"
Mounting position of screw-terminal capacitors	Do not mount the capacitor with the terminals (safety vent) upside down.	11.1. "Mounting positions of capacitors with screw terminals"
Robustness of terminals	The following maximum tightening torques must not be exceeded when connecting screw terminals: M5: 2.5 Nm M6: 4.0 Nm	11.3 "Mounting torques"
Mounting of single-ended capacitors	The internal structure of single-ended capacitors might be damaged if excessive force is applied to the lead wires. Avoid any compressive, tensile or flexural stress. Do not move the capacitor after soldering to PC board. Do not pick up the PC board by the soldered capacitor. Do not insert the capacitor on the PC board with a hole space different to the lead space specified.	11.4 "Mounting considerations for single-ended capacitors"
Soldering	Do not exceed the specified time or temperature limits during soldering.	11.5 "Soldering"
Soldering, cleaning agents	Do not allow halogenated hydrocarbons to come into contact with aluminum electrolytic capacitors.	11.6 "Cleaning agents"
Upper category temperature	Do not exceed the upper category temperature.	7.2 "Maximum permissible operating temperature"
Passive flammability	Avoid external energy, such as fire or electricity.	8.1 "Passive flammability"



Topic	Safety information	Reference chapter "General technical information"
Active flammability	Avoid overload of the capacitors.	8.2 "Active flammability"
Maintenance	Make periodic inspections of the capacitors. Before the inspection, make sure that the power supply is turned off and carefully discharge the electricity of the capacitors. Do not apply any mechanical stress to the capacitor terminals.	10 "Maintenance"
Storage	Do not store capacitors at high temperatures or high humidity. Capacitors should be stored at +5 to +35 °C and a relative humidity of $\leq 75\%$ .	7.3 Storage conditions
		Reference chapter "Capacitors with screw terminals"
Breakdown strength of insulating sleeves	Do not damage the insulating sleeve, especially when ring clips are used for mounting.	"Screw terminals – accessories"



**B43456, B43458**

**Extremely compact – 85 °C**

## Symbols and terms

Symbol	English	German
C	Capacitance	Kapazität
$C_R$	Rated capacitance	Nennkapazität
$C_S$	Series capacitance	Serienkapazität
$C_{S,T}$	Series capacitance at temperature T	Serienkapazität bei Temperatur T
$C_f$	Capacitance at frequency f	Kapazität bei Frequenz f
d	Case diameter, nominal dimension	Gehäusedurchmesser, Nennmaß
$d_{max}$	Maximum case diameter	Maximaler Gehäusedurchmesser
ESL	Self-inductance	Eigeninduktivität
ESR	Equivalent series resistance	Ersatzserienwiderstand
$ESR_f$	Equivalent series resistance at frequency f	Ersatzserienwiderstand bei Frequenz f
$ESR_T$	Equivalent series resistance at temperature T	Ersatzserienwiderstand bei Temperatur T
f	Frequency	Frequenz
I	Current	Strom
$I_{AC}$	Alternating current (ripple current)	Wechselstrom
$I_{AC,rms}$	Root-mean-square value of alternating current	Wechselstrom, Effektivwert
$I_{AC,f}$	Ripple current at frequency f	Wechselstrom bei Frequenz f
$I_{AC,max}$	Maximum permissible ripple current	Maximal zulässiger Wechselstrom
$I_{AC,R}$	Rated ripple current	Nennwechselstrom
$I_{AC,R} (B)$	Rated ripple current for base cooling	Nennwechselstromstrom für Bodenkühlung
$I_{leak}$	Leakage current	Reststrom
$I_{leak,op}$	Operating leakage current	Betriebsreststrom
l	Case length, nominal dimension	Gehäuselänge, Nennmaß
$l_{max}$	Maximum case length (without terminals and mounting stud)	Maximale Gehäuselänge (ohne Anschlüsse und Gewindebolzen)
R	Resistance	Widerstand
$R_{ins}$	Insulation resistance	Isolationswiderstand
$R_{symm}$	Balancing resistance	Symmetrierwiderstand
T	Temperature	Temperatur
$\Delta T$	Temperature difference	Temperaturdifferenz
$T_A$	Ambient temperature	Umgebungstemperatur
$T_C$	Case temperature	Gehäusetemperatur
$T_B$	Capacitor base temperature	Temperatur des Becherbodens
t	Time	Zeit
$\Delta t$	Period	Zeitraum
$t_b$	Service life (operating hours)	Brauchbarkeitsdauer (Betriebszeit)



Symbol	English	German
V	Voltage	Spannung
V <sub>F</sub>	Forming voltage	Formierspannung
V <sub>op</sub>	Operating voltage	Betriebsspannung
V <sub>R</sub>	Rated voltage, DC voltage	Nennspannung, Gleichspannung
V <sub>S</sub>	Surge voltage	Spitzenspannung
X <sub>C</sub>	Capacitive reactance	Kapazitiver Blindwiderstand
X <sub>L</sub>	Inductive reactance	Induktiver Blindwiderstand
Z	Impedance	Scheinwiderstand
Z <sub>T</sub>	Impedance at temperature T	Scheinwiderstand bei Temperatur T
tan δ	Dissipation factor	Verlustfaktor
λ	Failure rate	Ausfallrate
ε <sub>0</sub>	Absolute permittivity	Elektrische Feldkonstante
ε <sub>r</sub>	Relative permittivity	Dielektrizitätszahl
ω	Angular velocity; 2 · π · f	Kreisfrequenz; 2 · π · f

**Note**

All dimensions are given in mm.

## Important notes

The following applies to all products named in this publication:

1. Some parts of this publication contain **statements about the suitability of our products for certain areas of application**. These statements are based on our knowledge of typical requirements that are often placed on our products in the areas of application concerned. We nevertheless expressly point out **that such statements cannot be regarded as binding statements about the suitability of our products for a particular customer application**. As a rule, EPCOS is either unfamiliar with individual customer applications or less familiar with them than the customers themselves. For these reasons, it is always ultimately incumbent on the customer to check and decide whether an EPCOS product with the properties described in the product specification is suitable for use in a particular customer application.
2. We also point out that **in individual cases, a malfunction of electronic components or failure before the end of their usual service life cannot be completely ruled out in the current state of the art, even if they are operated as specified**. In customer applications requiring a very high level of operational safety and especially in customer applications in which the malfunction or failure of an electronic component could endanger human life or health (e.g. in accident prevention or lifesaving systems), it must therefore be ensured by means of suitable design of the customer application or other action taken by the customer (e.g. installation of protective circuitry or redundancy) that no injury or damage is sustained by third parties in the event of malfunction or failure of an electronic component.
3. **The warnings, cautions and product-specific notes must be observed.**
4. In order to satisfy certain technical requirements, **some of the products described in this publication may contain substances subject to restrictions in certain jurisdictions (e.g. because they are classed as hazardous)**. Useful information on this will be found in our Material Data Sheets on the Internet ([www.epcos.com/material](http://www.epcos.com/material)). Should you have any more detailed questions, please contact our sales offices.
5. We constantly strive to improve our products. Consequently, **the products described in this publication may change from time to time**. The same is true of the corresponding product specifications. Please check therefore to what extent product descriptions and specifications contained in this publication are still applicable before or when you place an order. We also **reserve the right to discontinue production and delivery of products**. Consequently, we cannot guarantee that all products named in this publication will always be available. The aforementioned does not apply in the case of individual agreements deviating from the foregoing for customer-specific products.
6. Unless otherwise agreed in individual contracts, **all orders are subject to the current version of the "General Terms of Delivery for Products and Services in the Electrical Industry" published by the German Electrical and Electronics Industry Association (ZVEI)**.
7. The trade names EPCOS, BAOKE, Alu-X, CeraDiode, CeraLink, CSMP, CSSP, CTVS, DeltaCap, DigiSiMic, DSSP, FilterCap, FormFit, MiniBlue, MiniCell, MKD, MKK, MLSC, MotorCap, PCC, PhaseCap, PhaseCube, PhaseMod, PhiCap, SIFERRIT, SIFI, SIKOREL, SilverCap, SIMDAD, SiMic, SIMID, SineFormer, SIOV, SIP5D, SIP5K, ThermoFuse, WindCap are **trademarks registered or pending** in Europe and in other countries. Further information will be found on the Internet at [www.epcos.com/trademarks](http://www.epcos.com/trademarks).