



DFNWB3×3-8L Plastic-Encapsulate MOSFETS

CJAE10P06 P-Channel Power MOSFET

$V_{(BR)DSS}$	$R_{DS(on)TYP}$	I_D
-60V	26mΩ@-10V	-10A



DESCRIPTION

The CJAE10P06 uses advanced trench technology and design to provide excellent $R_{DS(ON)}$ with low gate charge. It can be used in a wide variety of applications

FEATURES

- Battery switch
- Load switch
- High density cell design for ultra low $R_{DS(ON)}$
- Good stability and uniformity with high E_{AS}
- Excellent package for good heat dissipation
- Fully characterized avalanche voltage and current

APPLICATIONS

- SMPS and general purpose applications
- Hard switched and high frequency circuits
- Uninterruptible Power Supply

MARKING

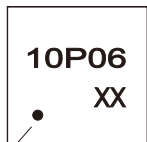

10P06=Part No.
Solid dot=Pin1 indicator.
XX=Code.

PIN 1

EQUIVALENT CIRCUIT

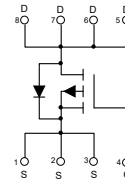

MAXIMUM RATINGS ($T_a=25^{\circ}C$ unless otherwise noted)

Parameter	Symbol	Limit	Unit
Drain-Source Voltage	V_{DS}	-60	V
Gate-Source Voltage	V_{GS}	±20	V
Continuous Drain Current	I_D ①	-10	A
Pulsed Drain Current	I_{DM} ②	-40	A
Single Pulsed Avalanche Energy	E_{AS} ③	180	mJ
Power Dissipation	P_D ①	3.0	W
Thermal Resistance from Junction to Ambient	$R_{\theta JA}$ ⑥	42	°CW
Operating Junction and Storage Temperature Range	T_J, T_{stg}	-55~+150	°C

MOSFET ELECTRICAL CHARACTERISTICS

$T_a=25^\circ\text{C}$ unless otherwise specified

Parameter	Symbol	Test Condition	Min	Typ	Max	Unit
Off characteristics						
Drain-source breakdown voltage	$V_{(BR)DSS}$	$V_{GS} = 0V, I_D = -250\mu A$	-60			V
Zero gate voltage drain current	I_{DSS}	$V_{DS} = -60V, V_{GS} = 0V$	$T_J = 25^\circ\text{C}$		1	μA
			$T_J = 125^\circ\text{C}$		300	
Gate-body leakage current	I_{GSS}	$V_{DS} = 0V, V_{GS} = \pm 20V$			± 100	nA
On characteristics ^④						
Gate-threshold voltage	$V_{GS(th)}$	$V_{DS} = V_{GS}, I_D = -250\mu A$	-1.0	-2.2	-3.0	V
Static drain-source on-state resistance	$R_{DS(on)}$	$V_{GS} = -10V, I_D = -10A$		26	35	m Ω
Dynamic characteristics ^{④ ⑤}						
Input capacitance	C_{iss}	$V_{DS} = -25V, V_{GS} = 0V, f = 1MHz$		4500		pF
Output capacitance	C_{oss}			705		
Reverse transfer capacitance	C_{rss}			515		
Gate resistance	R_g	$f = 1MHz$		6.0		Ω
Switching characteristics ^{④ ⑤}						
Total gate charge	Q_g	$V_{GS} = -10V, V_{DS} = -30V, I_D = -10A$		52		nC
Gate-source charge	Q_{gs}			12		
Gate-drain charge	Q_{gd}			15		
Turn-on delay time	$t_{d(on)}$	$V_{DD} = -30V, R_G = 3\Omega, R_L = 1.5\Omega, V_{GS} = -10V,$		16		ns
Turn-on rise time	t_r			18		
Turn-off delay time	$t_{d(off)}$			39		
Turn-off fall time	t_f			44		
Drain-Source Diode Characteristics						
Drain-source diode forward voltage	V_{SD} ^④	$V_{GS} = 0V, I_S = -1A$			-1.2	V
Continuous drain-source diode forward current	I_S ^①				-10	A
Pulsed drain-source diode forward current	I_{SM} ^②				-40	A

Notes:

1. $T_C = 25^\circ\text{C}$ Limited only by maximum temperature allowed.

2. $P_W \leq 10\mu s$, Duty cycle $\leq 1\%$.

3. EAS condition: $V_{DD} = -15V, V_{GS} = -10V, L = 0.5mH, R_g = 25\Omega$ Starting $T_J = 25^\circ\text{C}$.

4. Pulse Test : Pulse Width $\leq 300\mu s$, duty cycle $\leq 2\%$.

5. Guaranteed by design, not subject to production.

6. The value of $R_{\theta JA}$ is measured with the device mounted on 1 in 2 FR-4 board with 2oz. Copper, in a still air environment with $T_a = 25^\circ\text{C}$. $t \leq 10\text{sec}$.

Typical Characteristics

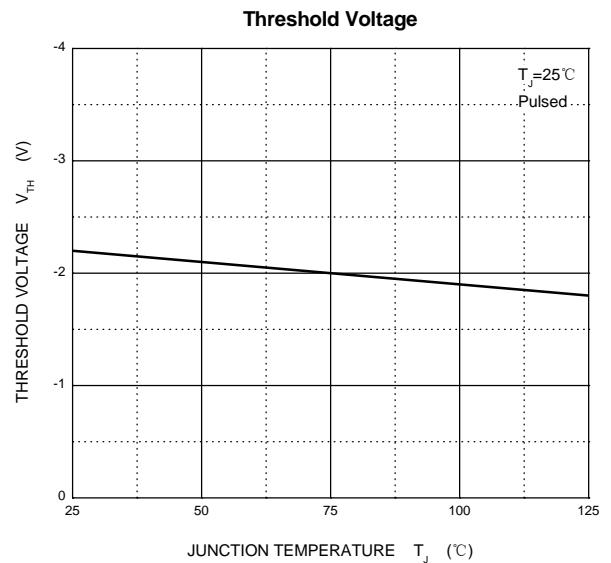
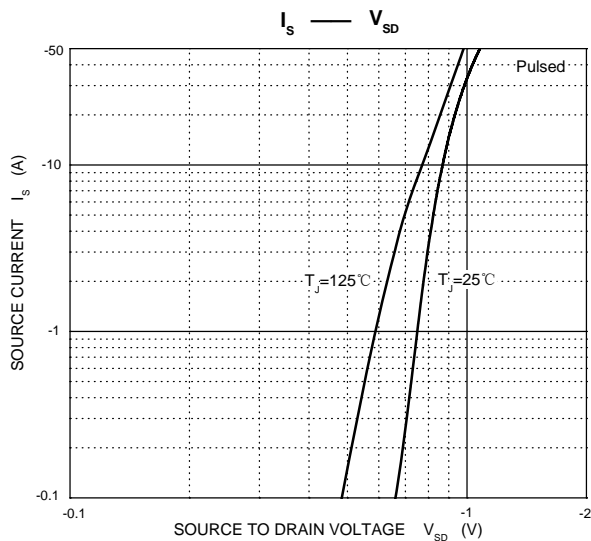
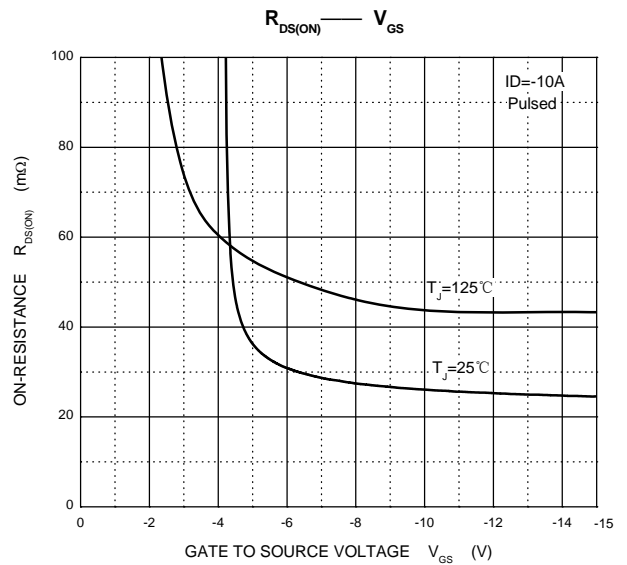
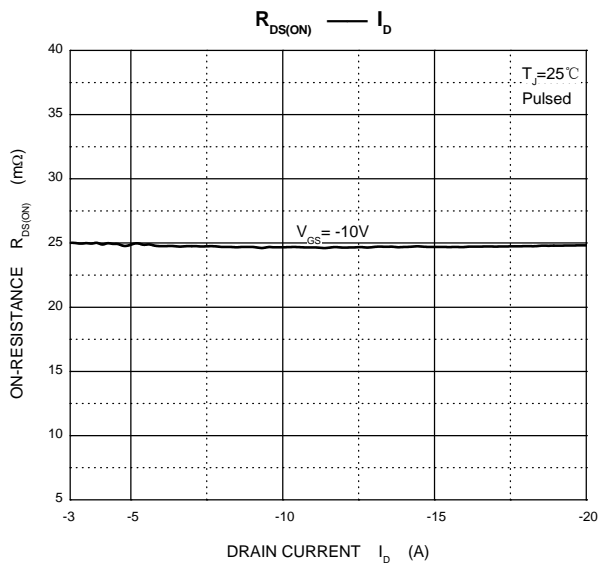
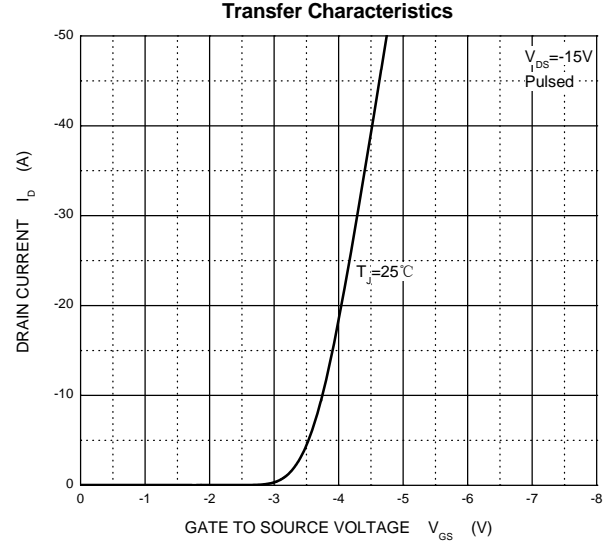
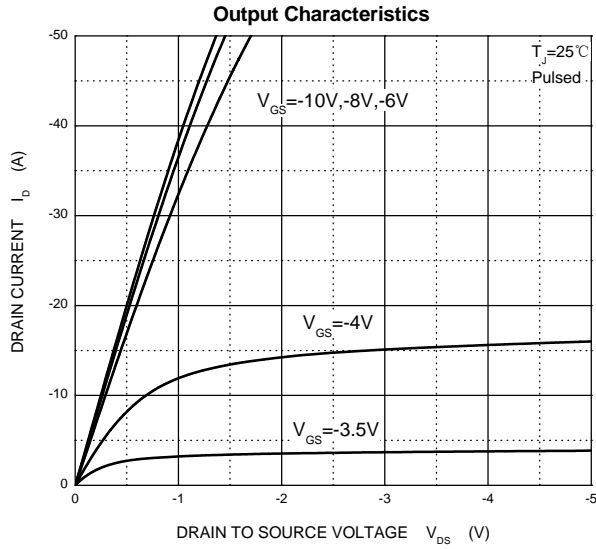

DFNWB3×3-8L Package Outline Dimensions

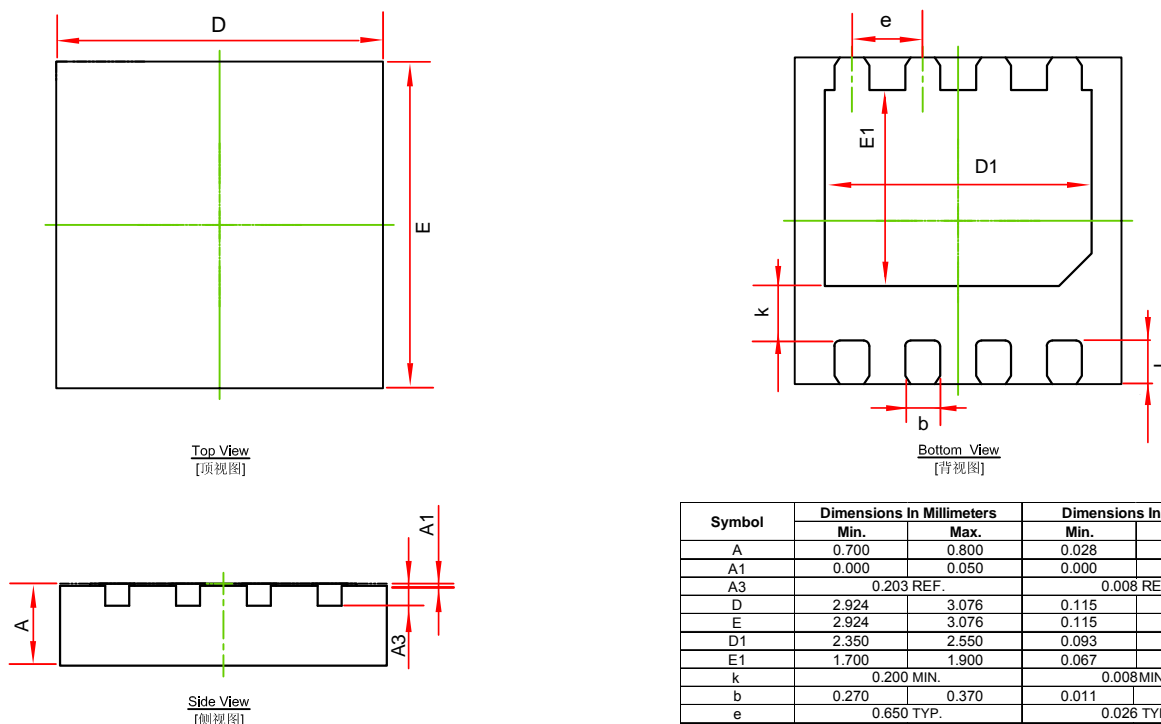

DFNWB3×3-8L Suggested Pad Layout

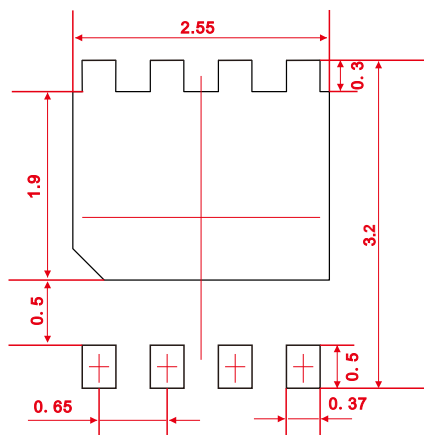

- Note:
1. Controlling dimension: in millimeters.
 2. General tolerance: $\pm 0.05\text{mm}$.
 3. The pad layout is for reference purposes only.

NOTICE

JSCJ reserves the right to make modifications, enhancements, improvements, corrections or other changes without further notice to any product herein. JSCJ does not assume any liability arising out of the application or use of any product described herein.

DFNWB3×3-8L Tape and Reel

DFNWB3×3-8L Embossed Carrier Tape

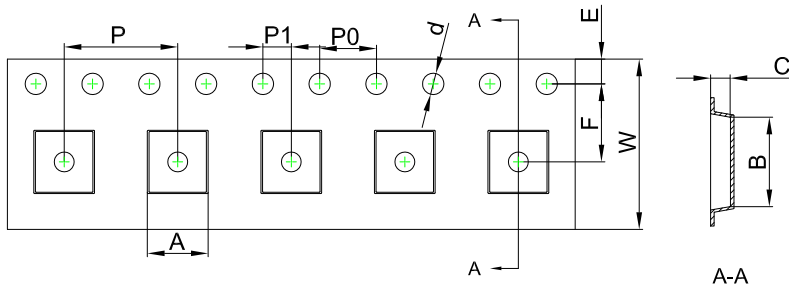

Packaging Description:

DFNWB3x3-8L parts are shipped in tape. The carrier tape is made from a dissipative (carbon filled) polycarbonate resin. The cover tape is a multilayer film (Heat Activated Adhesive in nature) primarily composed of polyester film, adhesive layer, sealant, and anti-static sprayed agent. These reeled parts in standard option are shipped with 5,000 units per 13" or 33.0 cm diameter reel. The reels are clear in color and is made of polystyrene plastic (anti-static coated).

Dimensions are in millimeter										
Pkg type	A	B	C	d	E	F	P0	P	P1	W
DFNWB3×3-8L	3.35	3.35	1.13	Ø1.50	1.75	5.50	4.00	8.00	2.00	12.00

DFNWB3×3-8L Tape Leader and Trailer

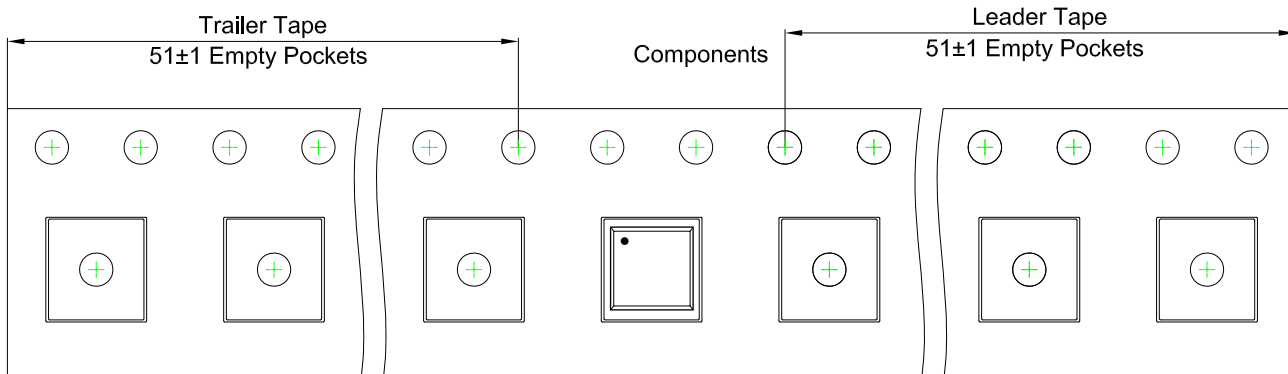

DFNWB3×3-8L Reel

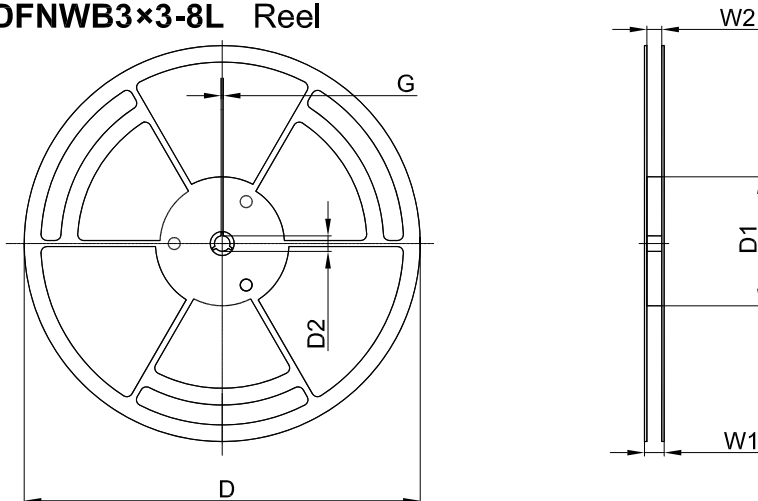

Dimensions are in millimeter						
Reel Option	D	D1	D2	G	W1	W2
13" Dia	Ø330.00	100.00	13.00	1.90	17.60	12.40

REEL	Reel Size	Box	Box Size(mm)	Carton	Carton Size(mm)
5,000 pcs	13 inch	10,000 pcs	360×360×65	50,000 pcs	378×358×382