

TO-126 Plastic-Encapsulate Transistors

BD439 / BD441 TRANSISTOR (NPN)

FEATURES

- Amplifier and Switching Applications
- Complement To BD440, BD442

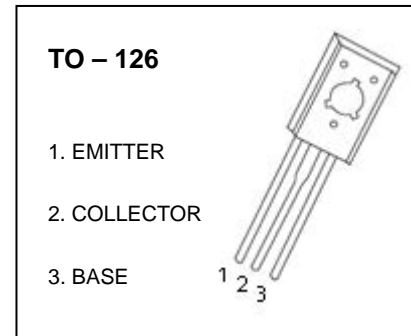

MARKING

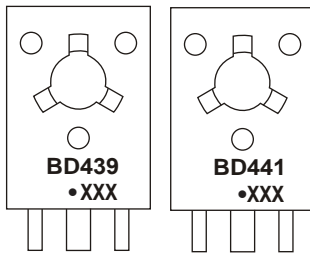

BD439, BD441 = Device code
Solid dot = Green molding compound device, if none, the normal device
XXX = Code

Equivalent Circuit

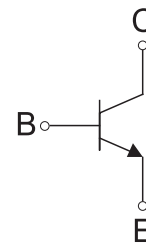

ORDERING INFORMATION

Part Number	Package	Packing Method	Pack Quantity
BD439	TO-126	Bulk	200pcs/Bag
BD441	TO-126	Bulk	200pcs/Bag
BD439-TU	TO-126	Tube	60pcs/Tube
BD441-TU	TO-126	Tube	60pcs/Tube

MAXIMUM RATINGS ($T_a=25^\circ\text{C}$ unless otherwise noted)

Symbol	Parameter	Value	Units
V_{CBO}	Collector-Base Voltage	BD439	60
		BD441	80
V_{CEO}	Collector-Emitter Voltage	BD439	60
		BD441	80
V_{EBO}	Emitter-Base Voltage	5	V
I_C	Collector Current –Continuous	4	A
P_C	Collector Power Dissipation	1.25	W
T_J, T_{stg}	Operation Junction and Storage Temperature Range	-55-150	$^\circ\text{C}$

ELECTRICAL CHARACTERISTICS

$T_a=25\text{ }^\circ\text{C}$ unless otherwise specified

Parameter	Symbol	Test conditions	Min	Typ	Max	Unit
Collector-base breakdown voltage	$V_{(BR)CBO}$	$I_C=100\mu\text{A}, I_E=0$ BD439 BD441	60 80			V
Collector-emitter breakdown voltage	$V_{CEO(SUS)}^{(1)}$	$I_C=100\text{mA}, I_B=0$ BD439 BD441	60 80			V
Emitter-base breakdown voltage	$V_{(BR)EBO}$	$I_E=100\mu\text{A}, I_C=0$	5			V
Collector cut-off current	I_{CBO}	$V_{CB}=60\text{V}, I_E=0$ $V_{CB}=80\text{V}, I_E=0$ BD439 BD441			100	μA
Emitter cut-off current	I_{EBO}	$V_{EB}=5\text{V}, I_E=0$			1	mA
DC current gain	$h_{FE(1)}^{(1)}$	$V_{CE}=1\text{V}, I_C=500\text{mA}$	40		475	
	$h_{FE(2)}^{(1)}$	$V_{CE}=5\text{V}, I_C=10\text{mA}$ BD439 BD441	20 15			
	$h_{FE(3)}^{(1)}$	$V_{CE}=1\text{V}, I_C=2\text{A}$ BD439 BD441	25 15			
Collector-emitter saturation voltage	$V_{CE(sat)}^{(1)}$	$I_C=3\text{A}, I_B=0.3\text{A}$			0.8	V
Base-emitter voltage	$V_{BE}^{(1)}$	$V_{CE}=1\text{V}, I_C=2\text{A}$			1.1	V
Transition frequency	f_T	$V_{CE}=1\text{V}, I_C=250\text{mA}$	3			MHz

⁽¹⁾Pulse test

Typical Characteristics

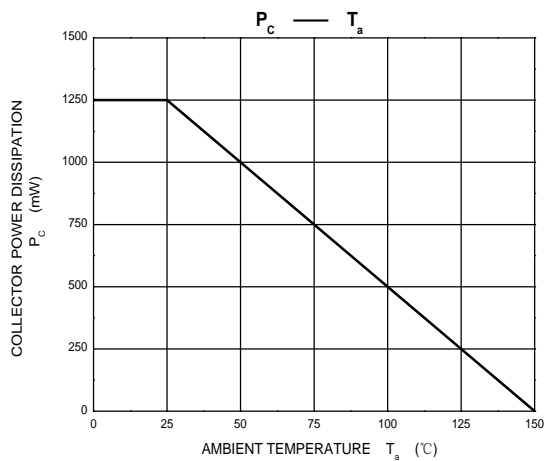
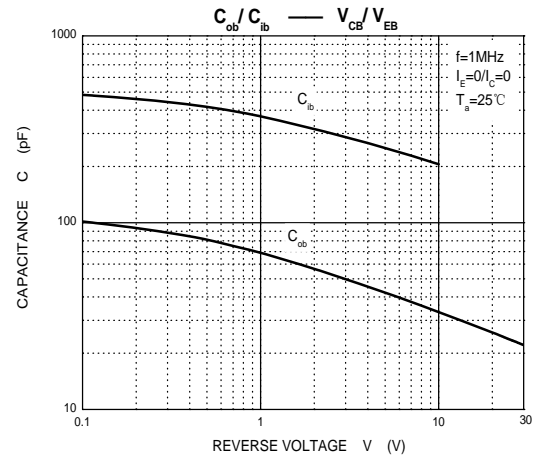
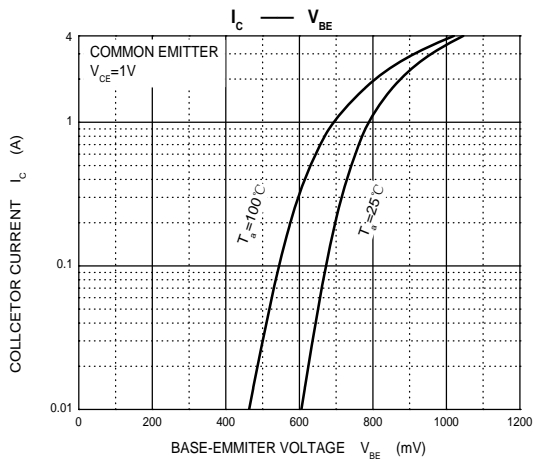
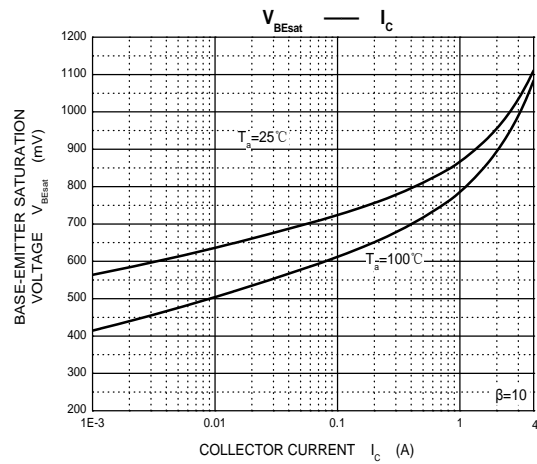
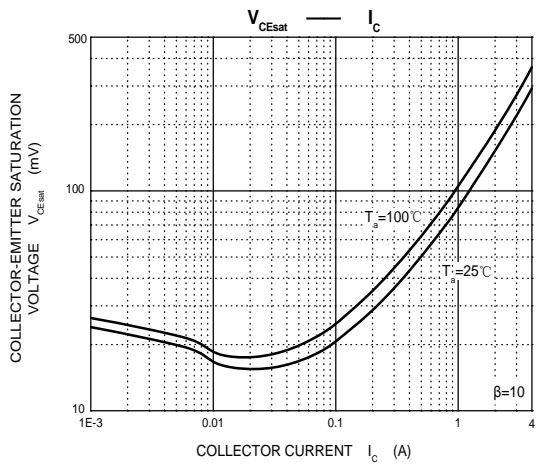
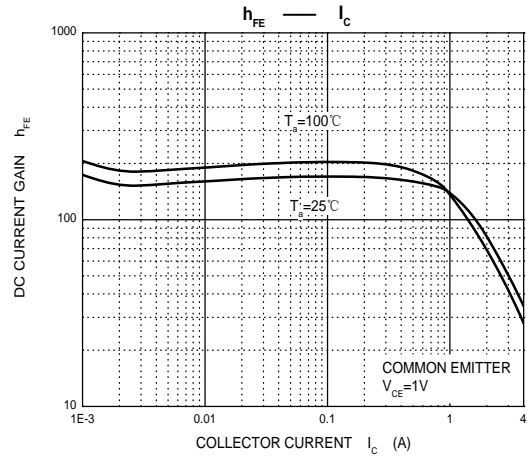
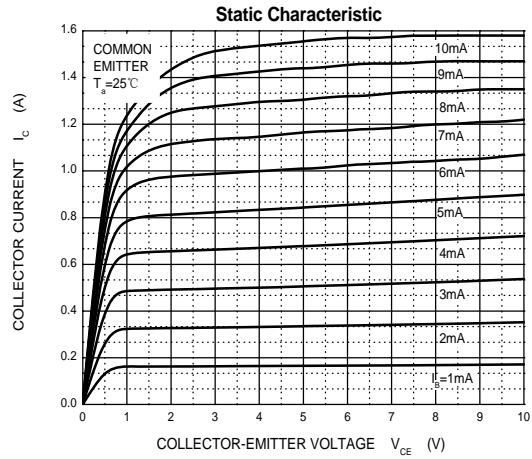

TO-126 Package Outline Dimensions

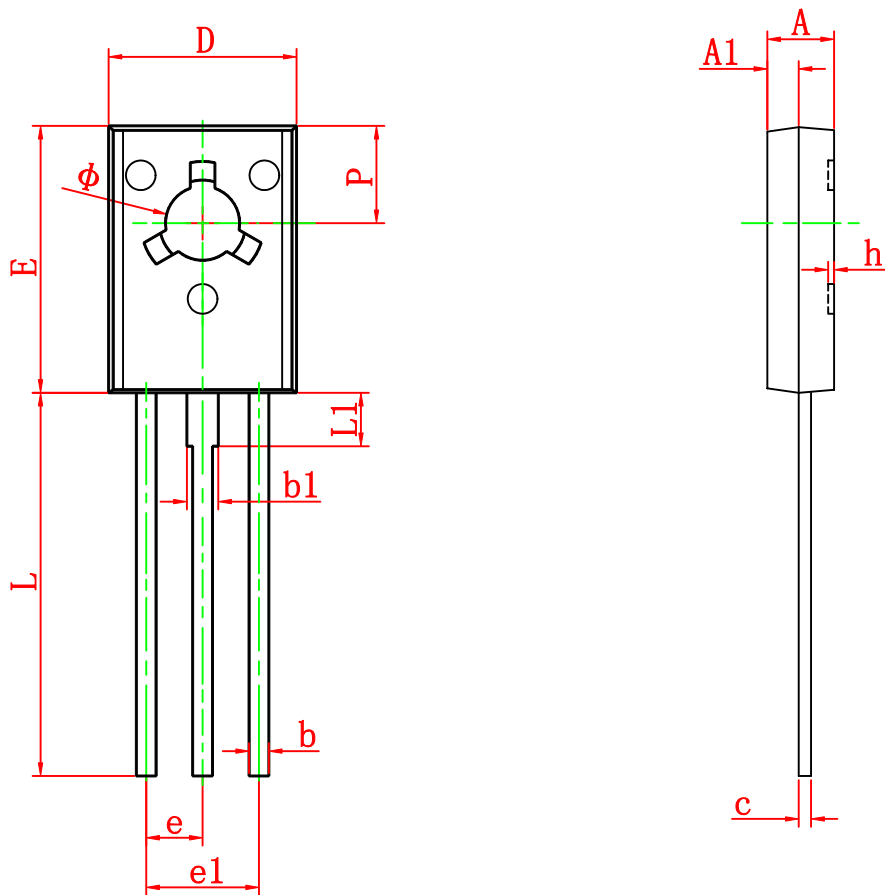

Symbol	Dimensions In Millimeters		Dimensions In Inches	
	Min	Max	Min	Max
A	2.500	2.900	0.098	0.114
A1	1.100	1.500	0.043	0.059
b	0.660	0.860	0.026	0.034
b1	1.170	1.370	0.046	0.054
c	0.450	0.600	0.018	0.024
D	7.400	7.800	0.291	0.307
E	10.600	11.000	0.417	0.433
e	2.290 TYP		0.090 TYP	
e1	4.480	4.680	0.176	0.184
h	0.000	0.300	0.000	0.012
L	15.300	15.700	0.602	0.618
L1	2.100	2.300	0.083	0.091
P	3.900	4.100	0.154	0.161
Φ	3.000	3.200	0.118	0.126