

Click [here](#) for production status of specific part numbers.

## MAX17612A/MAX17612B/ MAX17612C

## 4.5V to 60V, 250mA Current-Limiter with OV, UV, and Reverse Protection

### General Description

The Olympus series of ICs is the industry's smallest and robust integrated system protection solutions. The MAX17612A/MAX17612B/MAX17612C adjustable overvoltage and overcurrent protection devices are ideal to protect systems against positive and negative input voltage faults up to +60V and -65V, and feature low 1.42Ω (typ)  $R_{ON}$  FETs.

The adjustable input overvoltage protection range is 5.5V to 60V and the adjustable input undervoltage protection range is 4.5V to 59V. The input overvoltage-lockout (OVLO) and undervoltage-lockout (UVLO) thresholds are set using external resistors. Additionally, the devices offer an internal input undervoltage threshold at 4.2V (typ).

The devices feature programmable current-limit protection up to 250mA; hence, controlling the inrush current at startup while charging high capacitances at the output. Current-limit threshold is programmed by connecting a resistor from the SET1 pin to GND. When the device current reaches the programmed threshold, the device prevents further increases in current by modulating the FET resistance. The devices can be programmed to behave in three different ways under current-limit condition: Autoretry, Continuous, or Latch-off modes. The voltage appearing on the SET1 pin is proportional to the instantaneous current flowing through the device and is read by an ADC.

MAX17612A and MAX17612C block current flowing in the reverse direction (i.e., from OUT to IN) whereas MAX17612B allows current flow in the reverse direction. The devices feature thermal shutdown protection against excessive power dissipation.

The devices are available in a small, 10-pin (3mm x 3mm) TDFN-EP package. The devices operate over the -40°C to +125°C extended temperature range.

### Applications

- Sensor Systems
- Condition Monitoring
- Factory Sensors
- Process Instrumentation
- Weighing and Batching Systems
- Industrial Applications such as PLC, Network-Control Modules, Battery-Operated Modules

### Benefits and Features

- Robust Protection Reduces System Downtime
  - Wide Input-Supply Range: +4.5V to +60V
  - Hot Plug-in Tolerant Without TVS up to 35V Input Supply
  - Negative Input Tolerance to -65V
  - Low  $R_{ON}$  1.42Ω (typ)
  - Reverse Current-Blocking Protection
  - Thermal Overload Protection
  - Extended -40°C to +125°C Temperature Range
  - MAX17612A Enables OV, UV, and Reverse-Voltage Protection
  - MAX17612B Enables OV and UV Protection
  - MAX17612C Enables Reverse-Voltage Protection
- Flexible Design Options Enable Reuse and Less Requalification
  - Adjustable OVLO and UVLO Thresholds
  - Programmable Forward-Current Limit: 10mA to 20mA with ±6% Accuracy and 20mA to 250mA with ±5% Accuracy Over Full Temperature Range
  - Programmable Overcurrent Fault Response: Autoretry, Continuous, and Latch-Off Modes
  - Smooth Current Transitions
- Saves Board Space and Reduces External BOM Count
  - 10-Pin, 3mm x 3mm, TDFN-EP Package
  - Integrated FETs

[Ordering Information](#) appears at end of data sheet.

MAX17612A/MAX17612B/  
MAX17612C

4.5V to 60V, 250mA Current-Limiter with  
OV, UV, and Reverse Protection

Typical Operating Circuits

MAX17612A and MAX17612B

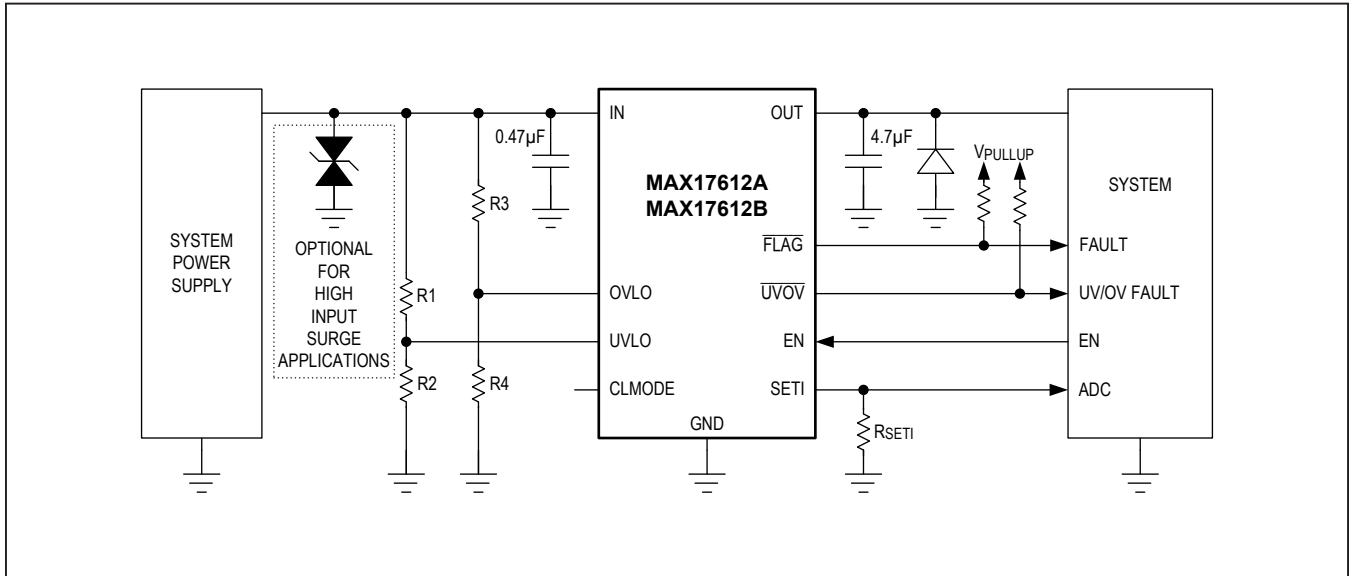

MAX17612C

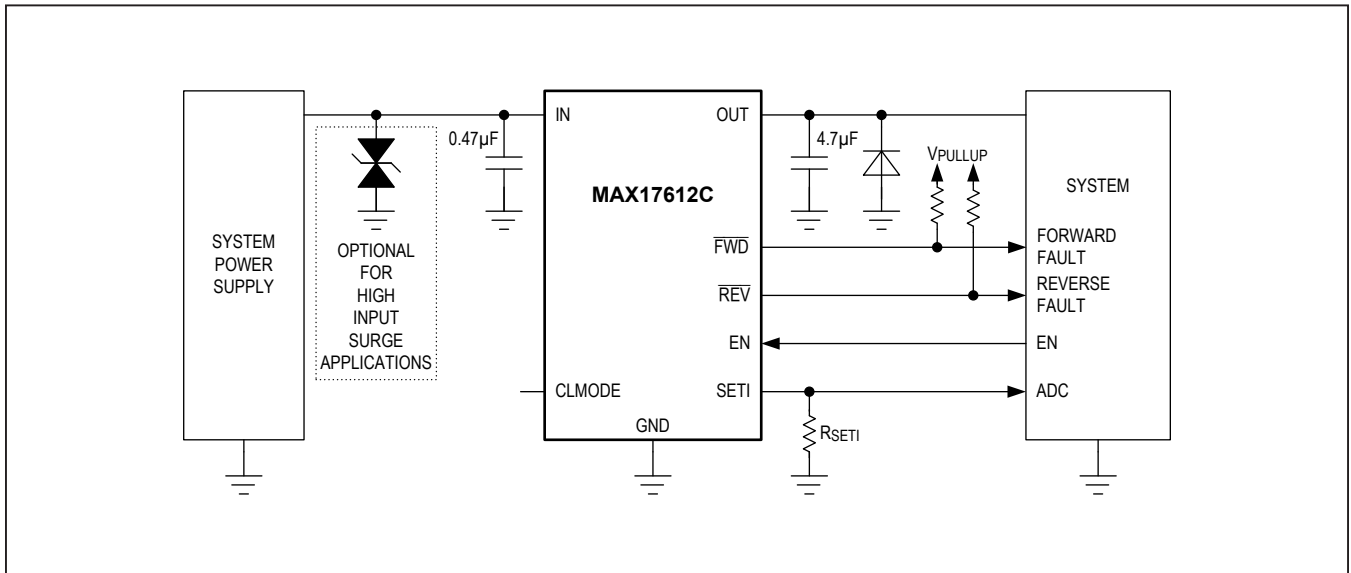

# MAX17612A/MAX17612B/ MAX17612C

# 4.5V to 60V, 250mA Current-Limiter with OV, UV, and Reverse Protection

## Absolute Maximum Ratings

IN to GND.....	-70V to +65V	SETI to GND (Note 1) .....	-0.3V to +1.6V
IN to OUT .....	-65V to +65V	Continuous Power Dissipation (10 pin TDFN-EP (T <sub>A</sub> = +70°C, derate 24.4mW/°C above +70°C)) ...	1951.2mW
OUT to GND .....	-0.3V to +65V	Extended Operating Temperature Range .....	-40°C to 125°C
UVLO, OVLO to GND .....	-0.3V to MAX(V <sub>IN</sub> , V <sub>OUT</sub> ) + 0.3V	Junction Temperature Range (Note 2) .....	-40°C to +150°C
UVOV, FLAG, FWD, REV, EN, CLMODE to GND .....	-0.3V to +6.0V	Storage Temperature Range .....	-65°C to +150°C
IN Current (DC) .....	262.5mA	Lead Temperature (Soldering, 10s).....	+300°C

**Note 1:** SETI pin is internally clamped. Forcing more than 5mA current into the pin can damage the device.

**Note 2:** Junction temperature greater than +125°C degrades operating lifetimes.

Stresses beyond those listed under "Absolute Maximum Ratings" may cause permanent damage to the device. These are stress ratings only, and functional operation of the device at these or any other conditions beyond those indicated in the operational sections of the specifications is not implied. Exposure to absolute maximum rating conditions for extended periods may affect device reliability.

## Package Information

<b>PACKAGE TYPE: 12 TDFN</b>	
Package Code	T1033+1C
Outline Number	<a href="#">21-0137</a>
Land Pattern Number	<a href="#">90-0003</a>
<b>THERMAL RESISTANCE, FOUR-LAYER BOARD:</b>	
Junction to Ambient (θ <sub>JA</sub> )	41°C/W
Junction to Case (θ <sub>JC</sub> )	9°C/W

For the latest package outline information and land patterns (footprints), go to [www.maximintegrated.com/packages](http://www.maximintegrated.com/packages). Note that a "+", "#", or "-" in the package code indicates RoHS status only. Package drawings may show a different suffix character, but the drawing pertains to the package regardless of RoHS status.

Package thermal resistances were obtained using the method described in JEDEC specification JESD51-7, using a four-layer board. For detailed information on package thermal considerations, refer to [www.maximintegrated.com/thermal-tutorial](http://www.maximintegrated.com/thermal-tutorial).

## Electrical Characteristics

(V<sub>IN</sub> = +4.5 to +60V, T<sub>A</sub> = -40°C to +125°C, unless otherwise noted. Typical values are at V<sub>IN</sub> = +24V, T<sub>A</sub> = +25°C, R<sub>SETI</sub> = 1.2kΩ.)  
(Note 3)

PARAMETER	SYMBOL	CONDITIONS	MIN	TYP	MAX	UNITS
IN Voltage Range	V <sub>IN</sub>		4.5		60	V
Shutdown Input Current	I <sub>SHDN</sub>	V <sub>EN</sub> = 0V		25	60	μA
Shutdown Output Current	I <sub>OFF</sub>	V <sub>EN</sub> = 0V, V <sub>OUT</sub> = 0V	-2	< 1	2	μA
Reverse Input Current	I <sub>IN_RVS</sub>	V <sub>IN</sub> = -60V, V <sub>OUT</sub> = 0V	-85	-50		μA
Supply Current	I <sub>IN</sub>	V <sub>IN</sub> = 24V, V <sub>EN</sub> = 5V		0.89	1.21	mA
Internal Undervoltage-Trip Level	V <sub>UVLO</sub>	V <sub>IN</sub> rising	3.46	4.22	4.50	V
		V <sub>IN</sub> falling		3.5		
UVLO, OVLO Reference	V <sub>REF</sub>		1.45	1.50	1.55	V
UVLO, OVLO Threshold Hysteresis				3.3		%
UVLO, OVLO Leakage Current	I <sub>LEAK</sub>	V <sub>UVLO</sub> = V <sub>OVLO</sub> = 0 to 2V. (MAX17612A, MAX17612B only)	-100		100	nA

MAX17612A/MAX17612B/  
MAX17612C

4.5V to 60V, 250mA Current-Limiter with  
OV, UV, and Reverse Protection

Electrical Characteristics (continued)

( $V_{IN} = +4.5$  to  $+60V$ ,  $T_A = -40^{\circ}C$  to  $+125^{\circ}C$ , unless otherwise noted. Typical values are at  $V_{IN} = +24V$ ,  $T_A = +25^{\circ}C$ ,  $R_{SETI} = 1.2k\Omega$ .)  
(Note 3)

PARAMETER	SYMBOL	CONDITIONS	MIN	TYP	MAX	UNITS
OVLO Adjustment Range		(Note 4)	5.5		60	V
UVLO Adjustment Range		(Note 4)	4.5		59	V
Internal POR			3.0		4.3	V
<b>INTERNAL FETs</b>						
Internal FETs On-Resistance	$R_{ON}$	$I_{LOAD} = 100mA$ , $V_{IN} \geq 8V$		1.42	2.7	$\Omega$
Current-Limit Adjustment Range	$I_{LIM}$	(Note 5)	10		250	mA
Current-Limit Accuracy		$10mA < I_{LIM} < 20mA$	-6		+6	%
		$20mA < I_{LIM} \leq 250mA$	-5		+5	
FLAG Assertion Drop-Voltage Threshold	$V_{FA}$	Increase ( $V_{IN} - V_{OUT}$ ) drop until $\overline{FLAG}$ asserts, $V_{IN} = 24V$ , $I_{IN} = 10mA$	370	470	570	mV
Reverse Current-Blocking Slow Threshold	$V_{RIBS}$	$(V_{OUT} - V_{IN})$ . (MAX17612A, MAX17612C only)	2	11	20	mV
Reverse Current-Blocking Debounce Blanking Time	$t_{DEBRIB}$	(MAX17612A, MAX17612C only)	100	140	180	$\mu s$
Reverse Current-Blocking Powerup Blanking Time	$t_{BLKRIB}$	(MAX17612A, MAX17612C only)	14.4	16.0	17.6	ms
Reverse Current-Blocking Fast Threshold	$V_{RIBF}$	$(V_{OUT} - V_{IN})$ . (MAX17612A, MAX17612C only)	70	105	140	mV
Reverse Current-Blocking Fast-Response Time	$t_{RIB}$	$I_{REVERSE} = 2.5A$ , (MAX17612A, MAX17612C only) (Note 6)		150	230	ns
Reverse-Blocking Supply Current	$I_{RBL}$	Current into OUT when $(V_{OUT} - V_{IN}) > 130mV$ . (MAX17612A, MAX17612C only)		0.89	1.25	mA
<b>SETI</b>						
$R_{SETI} \times I_{LIM}$	$V_{RI}$			1.5		V
Current-Mirror Output Ratio	$C_{IRATIO}$	$10mA \leq I_{OUT} \leq 20mA$	190	200	210	A/A
		$20mA \leq I_{OUT} \leq 250mA$	193	200	207	
Internal SETI Clamp		5mA into SETI	1.6		2.2	V
SETI Leakage Current		$V_{SETI} = 1.6V$	-0.1		0.1	$\mu A$
<b>LOGIC INPUT</b>						
EN Input-Logic High	$V_{IH}$		1.4			V
EN Input-Logic Low	$V_{IL}$				0.4	V
EN Pullup Voltage		EN pin unconnected. $V_{IN} = 60V$		1.3	2	V
EN Input Current		$V_{EN} = 5.5V$		60	92	$\mu A$
EN Pullup Current		$V_{EN} = 0.4V$	1.0	3.0	8.0	$\mu A$
CLMODE Input-Logic High			2.0	3.8	4.9	V
CLMODE Input-Logic Low			0.25	0.60	0.95	V
CLMODE Pullup Input Current			8	10	12	$\mu A$

### Electrical Characteristics (continued)

( $V_{IN} = +4.5$  to  $+60V$ ,  $T_A = -40^{\circ}C$  to  $+125^{\circ}C$ , unless otherwise noted. Typical values are at  $V_{IN} = +24V$ ,  $T_A = +25^{\circ}C$ ,  $R_{SETI} = 1.2k\Omega$ .)  
(Note 3)

PARAMETER	SYMBOL	CONDITIONS	MIN	TYP	MAX	UNITS
<b>FLAG, UVOV, FWD, REV OUTPUTS</b>						
FLAG, UVOV, FWD, REV Output-Logic Low Voltage		$I_{SINK} = 1mA$			0.4	V
FLAG, UVOV, FWD, REV Output-Leakage Current		$V_{IN} = V_{FLAG} = V_{UVOV} = V_{FWD} = V_{REV} = 5.5V$ . FLAG, UVOV, FWD and REV pins are deasserted			1	$\mu A$
<b>TIMING CHARACTERISTICS</b>						
Switch Turn-On Time	$t_{ON\_SWITCH}$	$V_{IN} = 24V$ , $R_{LOAD} = 1k\Omega$ , $C_{LOAD} = 0pF$ , $R_{SETI} = 1.2k\Omega$		230	450	$\mu s$
Oversvoltage Switch Turn-Off Time	$t_{OFF\_OVP}$	$V_{OVLO}$ exceeds $V_{REF}$ as a step; $R_{LOAD} = 1k\Omega$		0.46	0.65	$\mu s$
Oversvoltage Falling-Edge Debounce Time	$t_{DEB\_OVP}$			20		$\mu s$
Overcurrent Protection Response Time	$t_{OCP\_RES}$	$I_{LIM} = 0.25A$ , $C_{LOAD} = 0$ , $I_{OUT}$ step from 0.125A to 0.375A. Time to regulate $I_{OUT}$ to current limit.		100		$\mu s$
IN Debounce Time	$t_{DEB}$	From $V_{IN\_UVLO} < V_{IN} < V_{IN\_OVLO}$ and EN = High to $V_{OUT} = 10\%$ of $V_{IN}$ . Elapses only at power-up.	14.4	16	17.6	ms
Current-Limit Smooth-Transition Time	$t_{REF\_RAMP}$			100		$\mu s$
Current-Limit Blanking Time	$t_{BLANK}$		36	40	44	ms
Current-Limit Autoretry Time	$t_{RETRY}$	After blanking time from $I_{OUT} > I_{LIM}$ to FLAG deasserted (Note 7)	540	600	660	ms
<b>THERMAL PROTECTION</b>						
Thermal Shutdown	$T_J$			160		$^{\circ}C$
Thermal Shutdown Hysteresis	$T_{J(HYS)}$			28		$^{\circ}C$

**Note 3:** All devices are 100% production tested at  $T_A = +25^{\circ}C$ . Limits over the operating-temperature range are guaranteed by design; not production tested.

**Note 4:** User settable. See the [Oversvoltage Lockout \(OVLO\)](#) and [Undersvoltage Lockout \(UVLO\)](#) sections for instructions.

**Note 5:** The current limit can be set below 100mA with a decreased accuracy.

**Note 6:** Guaranteed by design; not production tested.

**Note 7:** The ratio between autoretry time and blanking time is fixed and equal to 15.

Typical Operating Characteristics

( $C_{IN} = 0.47\mu F$ ,  $C_{OUT} = 4.7\mu F$ ,  $T_A = +25^\circ C$ , unless otherwise noted.)

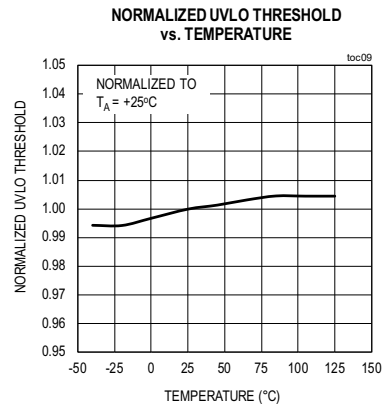
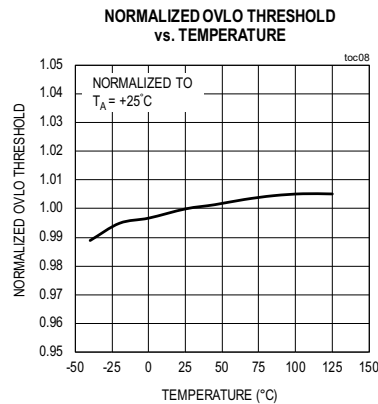
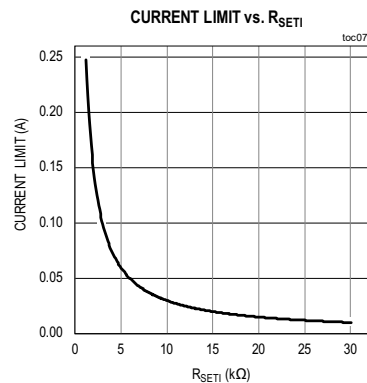
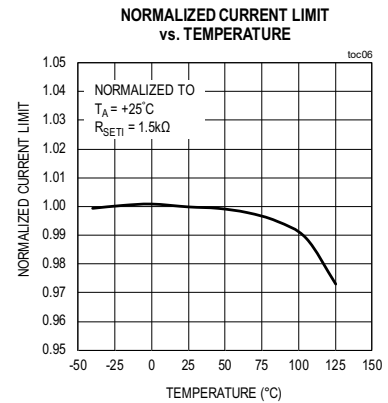
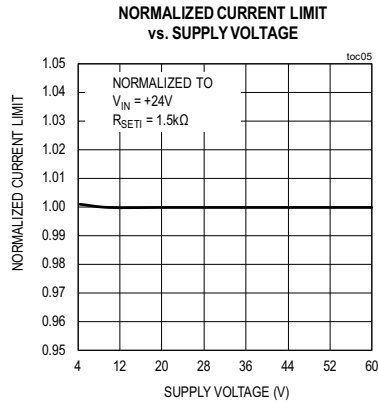
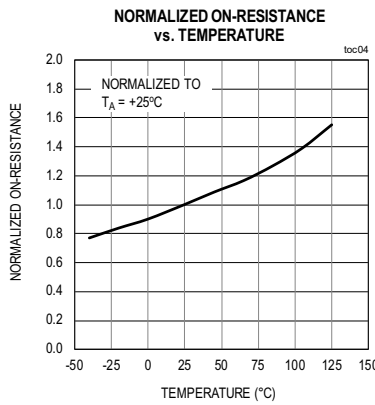
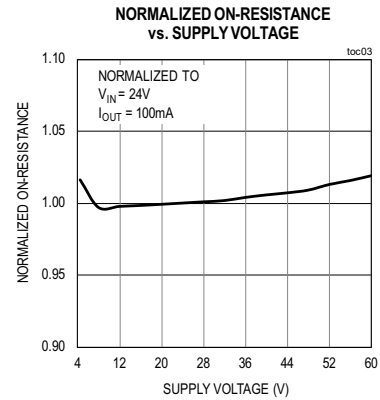
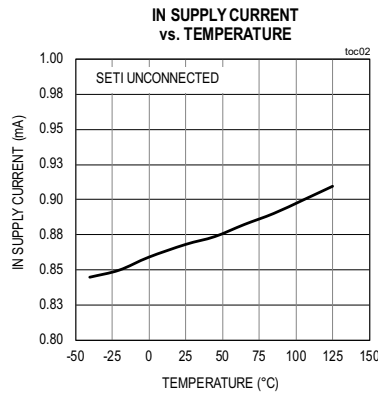
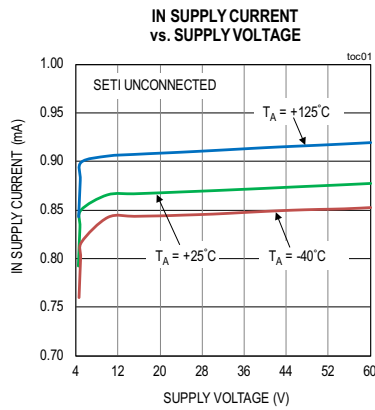

**Typical Operating Characteristics (continued)**

( $C_{IN} = 0.47\mu F$ ,  $C_{OUT} = 4.7\mu F$ ,  $T_A = +25^\circ C$ , unless otherwise noted.)

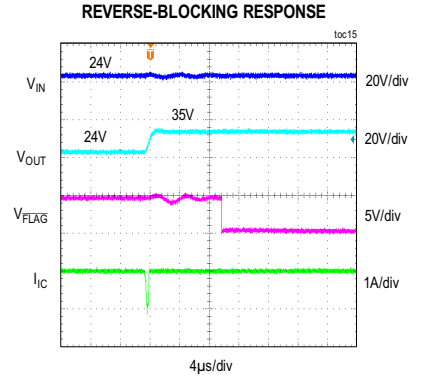
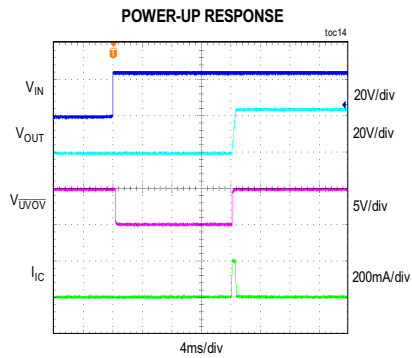
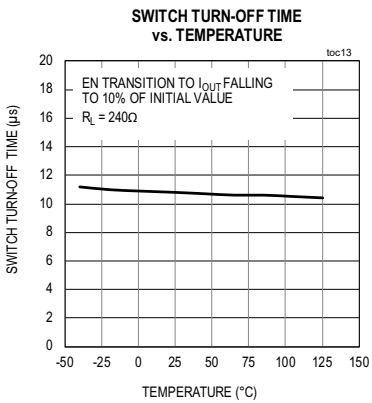
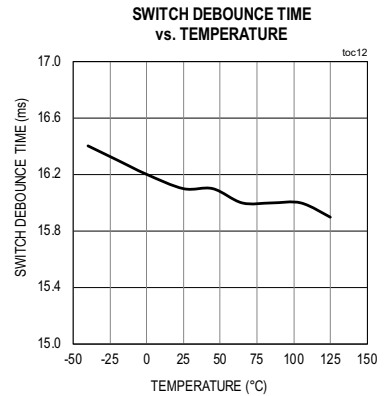
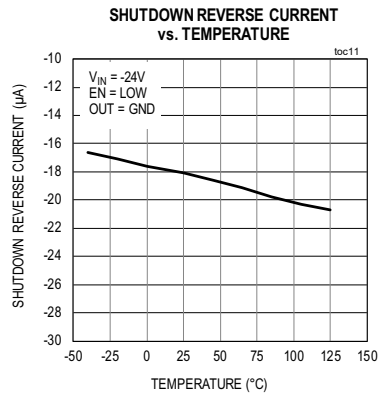
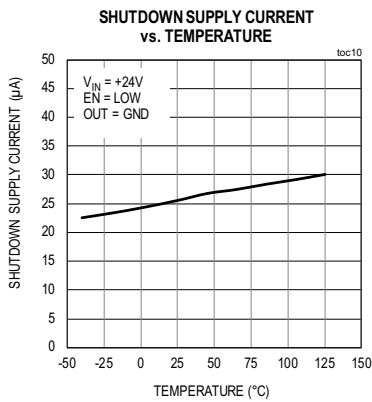

**Typical Operating Characteristics (continued)**

( $C_{IN} = 0.47\mu F$ ,  $C_{OUT} = 4.7\mu F$ ,  $T_A = +25^\circ C$ , unless otherwise noted.)

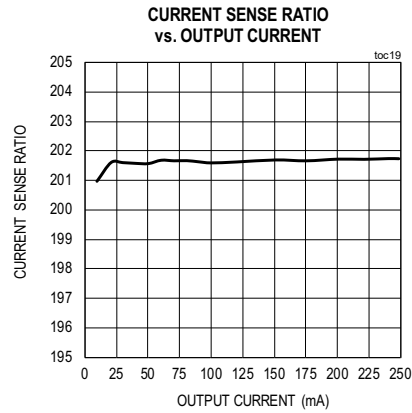
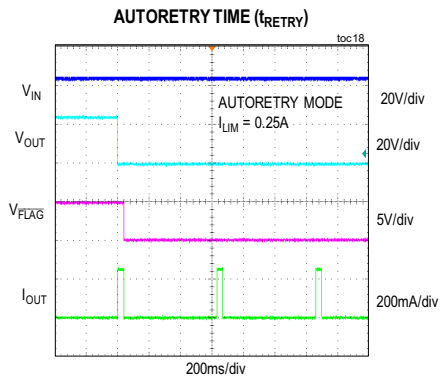
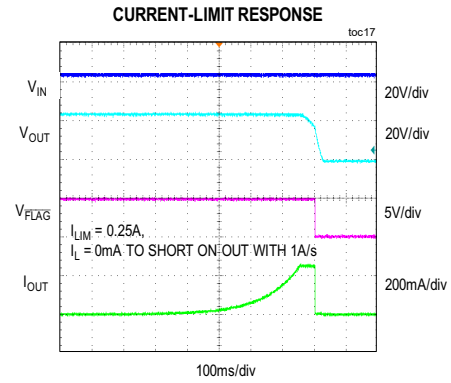
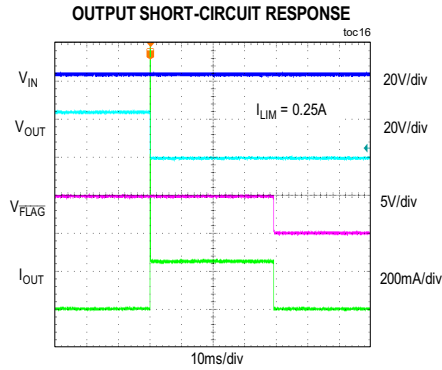



### Pin Configurations

#### MAX17612A and MAX17612B

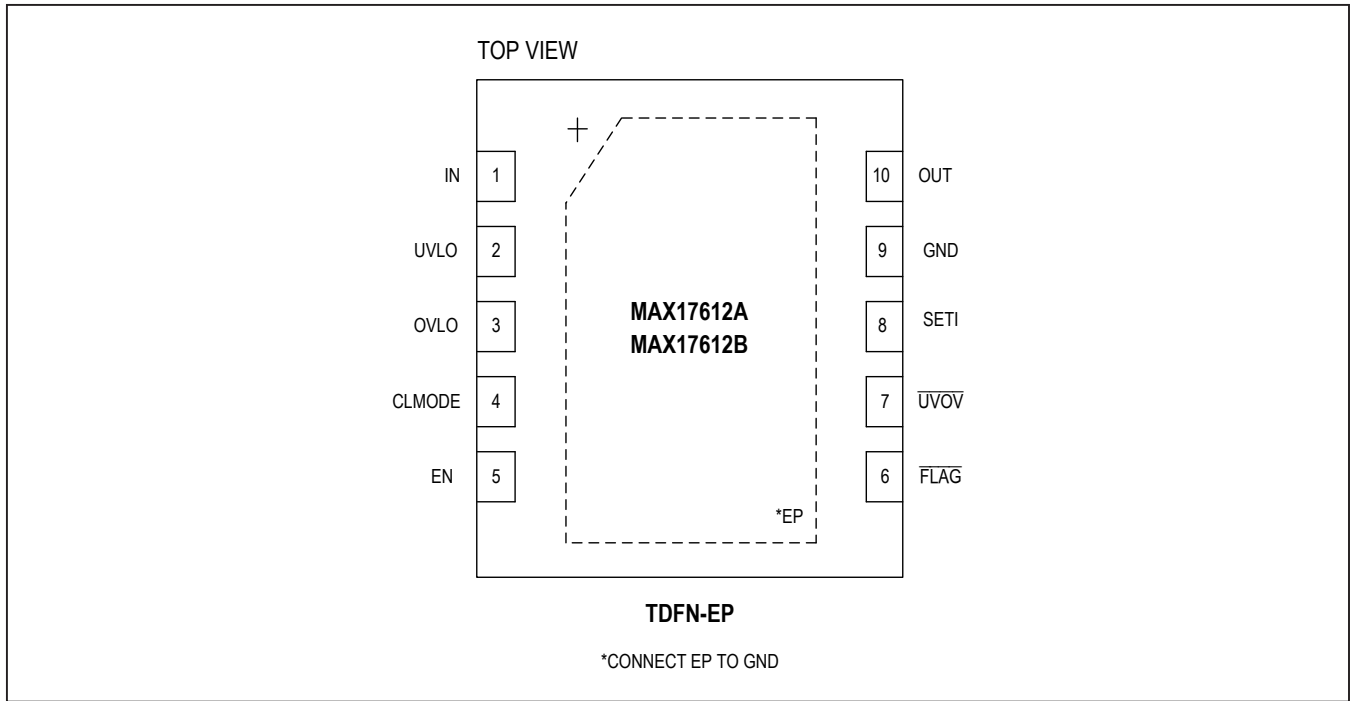

#### MAX17612C

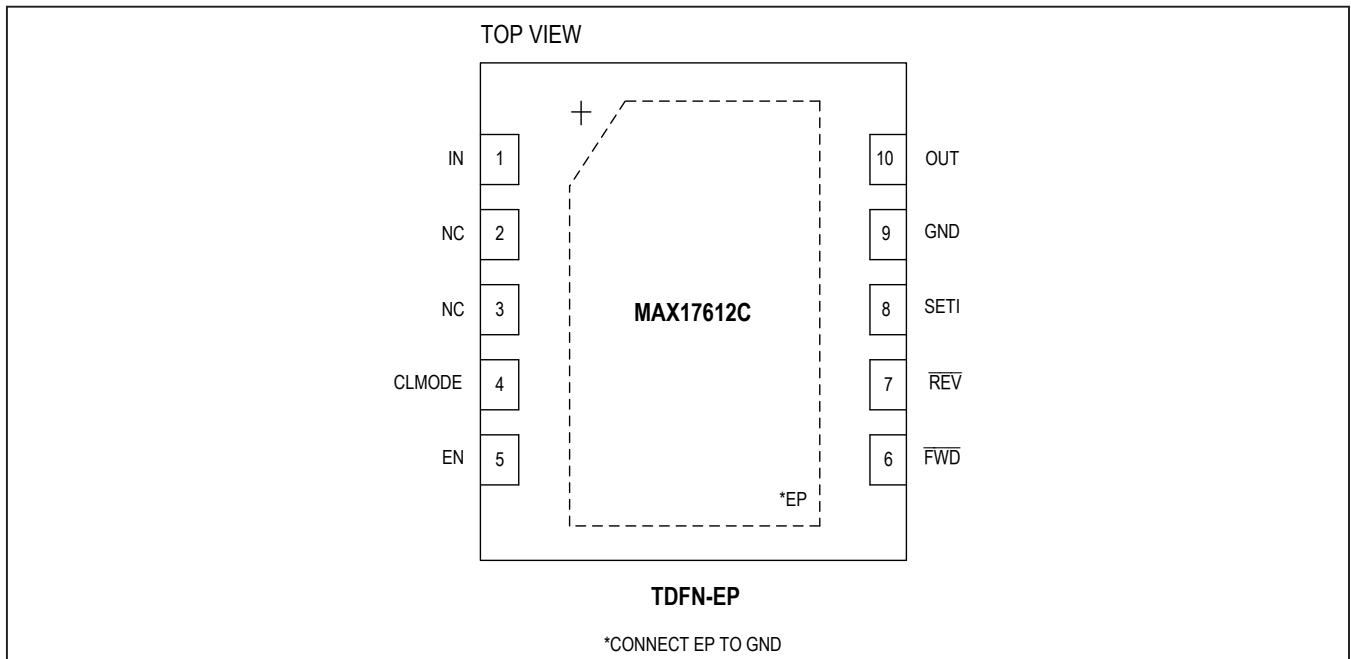

## Pin Description

PIN		NAME	FUNCTION
MAX17612A MAX17612B	MAX17612C		
1	1	IN	Input Pins. Connect a low-ESR ceramic capacitor to GND. For Hot Plug-In applications, see the <a href="#">Applications Information</a> section.
2	—	UVLO	UVLO Adjustment. Connect resistive potential divider from IN to GND to set the UVLO threshold.
—	2-3	N.C.	Not Connected. Leave unconnected.
3	—	OVLO	OVLO Adjustment. Connect resistive potential divider from IN to GND to set the OVLO threshold.
4	4	CLMODE	Current-Limit Mode Selector. Connect CLMODE to GND for Continuous mode. Connect a 150k $\Omega$ resistor between CLMODE and GND for Latch-off mode. Leave CLMODE unconnected for Autoretry mode.
5	5	EN	Active-High Enable Input. Internally pulled up to 1.8V.
6	—	$\overline{\text{FLAG}}$	Open-Drain, Fault Indicator Output. $\overline{\text{FLAG}}$ goes low when: <ul style="list-style-type: none"> <li>Overcurrent duration exceeds the blanking time.</li> <li>Reverse current is detected (MAX17612A only).</li> <li>Thermal shutdown is active.</li> <li>RSETI is less than 1k<math>\Omega</math> (max).</li> </ul>
—	6	$\overline{\text{FWD}}$	Open-Drain, Fault Indicator Output. $\overline{\text{FWD}}$ goes low when: <ul style="list-style-type: none"> <li>Overcurrent duration exceeds the blanking time.</li> <li>Thermal shutdown is active.</li> <li>RSETI is less than 1k<math>\Omega</math> (max).</li> </ul>
7	—	$\overline{\text{UVOV}}$	Open-Drain, Fault Indicator Output. $\overline{\text{UVOV}}$ goes low when: <ul style="list-style-type: none"> <li>Input voltage falls below UVLO threshold.</li> <li>Input voltage rises above OVLO threshold.</li> </ul>
—	7	$\overline{\text{REV}}$	Open-Drain, Fault Indicator Output. $\overline{\text{REV}}$ goes low when reverse current is detected.
8	8	SETI	Overcurrent Limit Adjustment Pin and Current Monitoring Output. Connect a resistor from SETI to GND to set overcurrent limit. See the <a href="#">Setting Current-Limit Threshold</a> section.
9	9	GND	Ground.
10	10	OUT	Output Pins. For a long output cable or inductive load, see the <a href="#">Applications Information</a> section.
—	—	EP	Exposed Pad. Connect EP to a large GND plane with several thermal vias for best thermal performance. Refer to the MAX17612A EV kit data sheet for a reference layout design.

Functional Diagrams

MAX17612A-MAX17612B

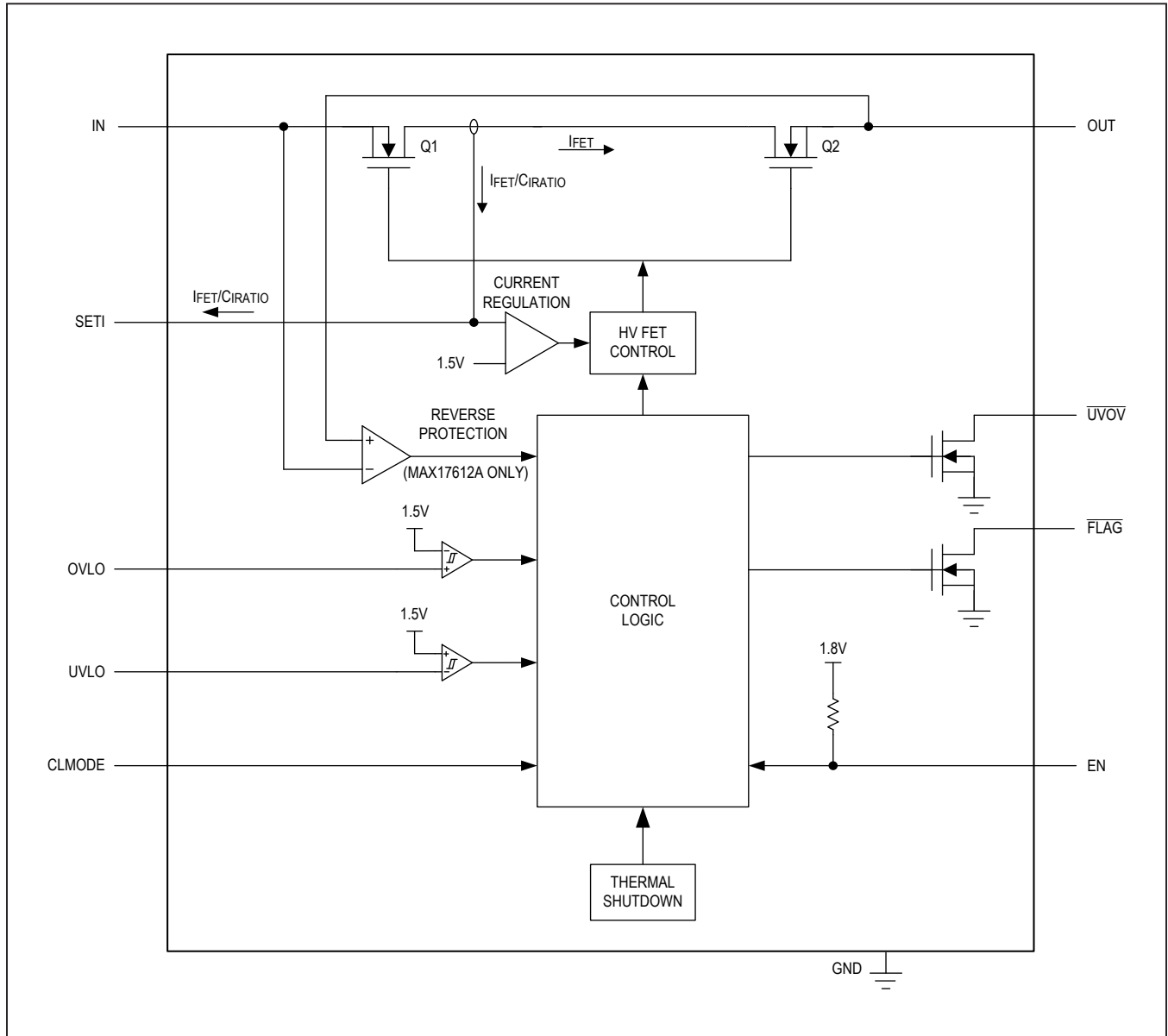

Functional Diagrams (continued)

MAX17612C

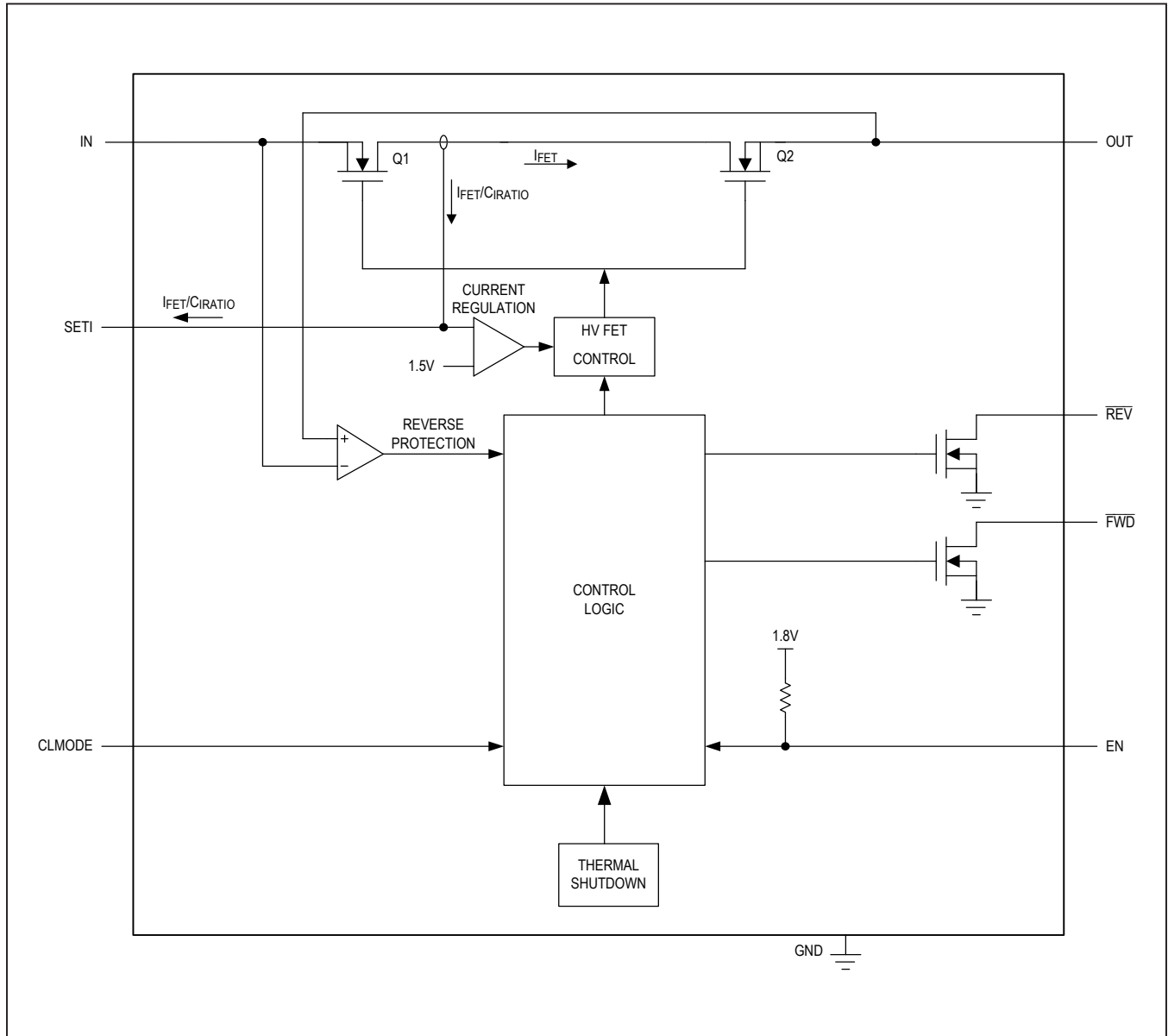

# MAX17612A/MAX17612B/ MAX17612C

# 4.5V to 60V, 250mA Current-Limiter with OV, UV, and Reverse Protection

## Detailed Description

The MAX17612A/MAX17612B/MAX17612C overvoltage- and overcurrent-protection devices offer adjustable protection boundaries for systems against input positive and negative faults up to +60V and -65V, and output load current up to 1A. The devices feature two internal MOSFETs connected in series with a low cumulative  $R_{ON}$  of 1.42m $\Omega$  (typ). The devices block out negative input voltages completely. Input undervoltage protection can be programmed between 4.5V and 59V, while the overvoltage protection can be independently programmed between 5.5V and 60V. Additionally, the devices have an internal default undervoltage lockout set at 4.2V (typ).

The devices are enabled or disabled through the EN pin by a master supervisory system; hence, offering a switch operation to turn on or turn off power delivery to connected load.

The current through the devices is limited by setting a current limit, which is programmed by a resistor connected from SETI to GND. The current limit can be programmed between 10mA to 250mA. When the device current reaches or exceeds the set current limit, the on-resistance of the internal FETs are modulated to limit the current to set limits. The devices offer three different behavioral models when under current limited operations: Autoretry, Continuous, and Latch-Off modes. The SETI pin also presents a voltage with reference to GND, which under normal operation is proportional to the device current. The voltage appearing on the SETI pin is read by an ADC on the monitoring system for recording instantaneous device current. To avoid oscillation, do not connect more than 10pF to the SETI pin.

The devices offer communication signals to indicate different operational and fault signals. MAX17612A and MAX17612B offer  $\overline{FLAG}$  and  $\overline{UVOV}$  signals, while MAX17612C offers  $\overline{FWD}$  and  $\overline{REV}$  signals. All communication signal pins are open drain in nature and require external pullup resistors to appropriate system interface voltage.

MAX17612A and MAX17612C block reverse current flow (from OUT to IN) while MAX17612B allows reverse current flow.

All three devices offer internal thermal shutdown protection against excessive power dissipation.

## Undervoltage Lockout (UVLO)

MAX17612A and MAX17612B have a UVLO adjustment range from 4.5V to 59V. Connect an external resistive potential divider to the UVLO pin as shown in the [Typical](#)

[Operating Circuits](#) to adjust the UVLO threshold voltage. Use the following equation to adjust the UVLO threshold. The recommended value of R1 is 2.2M $\Omega$ .

$$V_{UVLO} = V_{REF} \times \left[ 1 + \frac{R1}{R2} \right]$$

where  $V_{REF} = 1.5V$ .

All three devices have an input UVLO threshold set at 4.2V (typ). MAX17612C has no UVLO pin to adjust the UVLO threshold voltage externally.

## Overvoltage Lockout (OVLO)

MAX17612A and MAX17612B devices have an OVLO adjustment range from 5.5V to 60V. Connect an external resistive potential divider to the OVLO pin as shown in the [Typical Operating Circuits](#) to adjust the OVLO threshold voltage. Use the following equation to adjust the OVLO threshold. The recommended value of R3 is 2.2M $\Omega$ .

$$V_{OVLO} = V_{REF} \times \left[ 1 + \frac{R3}{R4} \right]$$

where  $V_{REF} = 1.5V$ .

The MAX17612C device has no OVLO pin to adjust the OVLO threshold voltage.

The OVLO reference voltage ( $V_{REF}$ ) is set at 1.5V. If the voltage at the OVLO pin exceeds  $V_{REF}$  for time equal to the overvoltage switch turn-off time ( $t_{OFF\_OVP}$ ), the switch is turned off and  $\overline{UVOV}$  is asserted. When the OVLO condition is removed, the device takes the overvoltage falling-edge debounce time ( $t_{DEB\_OVP}$ ) to start the switch turn-on process. The switch turns back on after switch turn-on time ( $t_{ON\_SWITCH}$ ) and  $\overline{UVOV}$  is deasserted. [Figure 1](#) depicts typical behavior in overvoltage conditions.

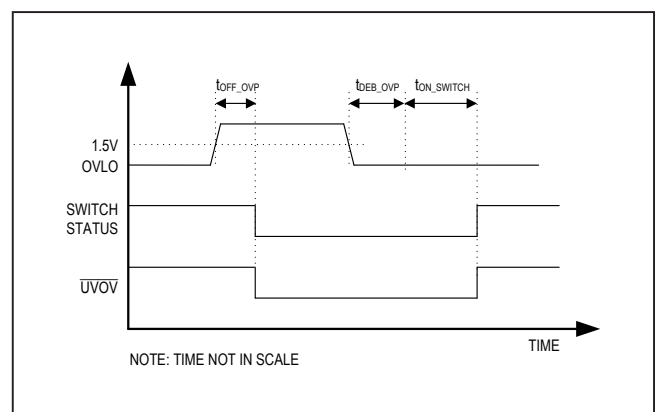

Figure 1. Overvoltage-Fault Timing Diagram

### Input Debounce Protection

The devices feature input debounce protection. The devices start operation (turn on the internal FETs) only if the input voltage is higher than UVLO threshold for a period greater than the debounce time ( $t_{DEB}$ ). The  $t_{DEB}$  elapses only at power-up of the devices. This feature is intended for applications where the EN signal is present when the power supply ramps up. [Figure 2](#) depicts a typical debounce timing diagram.

### Enable

The devices are enabled or disabled through the EN pin by driving it above or below the EN threshold voltage. Hence the devices can be used to turn on or off power delivery to connected loads using the EN pin.

### Setting Current-Limit Threshold

Connect a resistor between SET1 and GND to program the current-limit threshold in the devices. Use the following equation to calculate current-limit setting resistor:

$$R_{SET1}(k\Omega) = \frac{300}{I_{LIM}(mA)}$$

where  $I_{LIM}$  is the desired current limit in mA.

Do not use a  $R_{SET1}$  smaller than 1.5k $\Omega$ . [Table 1](#) shows current-limit thresholds for different resistor values.

The devices feature read-out of the current flowing into the IN pin. A current mirror, with a ratio of  $C_{IRATIO}$ , is implemented, using a current-sense auto-zero operational amplifier. The mirrored current flows out through the SET1 pin, into the external current-limit resistor. The voltage on the SET1 pin provides information about the IN current with the following relationship:

$$I_{IN-OUT}(A) = \frac{V_{SET1}(V)}{R_{SET1}(k\Omega)}$$

If SET1 is left unconnected,  $V_{SET1} \geq 1.5V$ . The current regulator does not allow any current to flow. During startup, this causes the switches to remain off and  $\overline{FLAG}$  (or  $\overline{FWD}$ ) to assert after  $t_{BLANK}$  elapses. During startup, 270 $\mu A$  current is forced to flow through  $R_{SET1}$ . If the voltage at SET1 is below 150mV, the switches remain off and  $\overline{FLAG}$  (or  $\overline{FWD}$ ) asserts.

### Current-Limit Type Select

The CLMODE pin is used to program the overcurrent response of the devices in one of the following three modes:

Autoretry mode (CLMODE pin is left unconnected), Continuous mode (CLMODE pin is connected to GND), Latch-off mode (a 150k $\Omega$  resistor is connected between CLMODE and GND).

**Table 1. Current-Limit Threshold vs. SET1-Resistor Values**

$R_{SET1}$ (k $\Omega$ )	CURRENT LIMIT (mA)
30	10
12	25
6	50
3	100
2	150
1.5	200
1.2	250

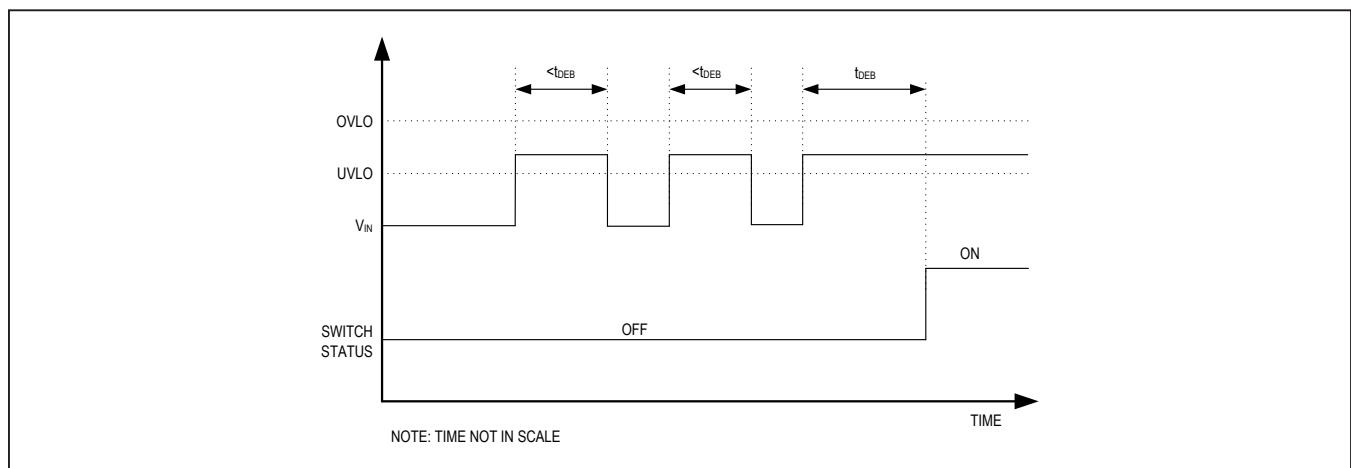

Figure 2. Debounce Timing Diagram

### Autoretry Current Limit

In autoretry current-limit mode, when current through the device reaches the current-limit threshold, the  $t_{BLANK}$  timer begins counting. The  $\overline{FLAG}$  (or  $\overline{FWD}$ ) pin asserts if the overcurrent condition is present for  $t_{BLANK}$ . The timer resets if the overcurrent condition resolves before  $t_{BLANK}$  has elapsed. A retry time delay ( $t_{RETRY}$ ) starts immediately after  $t_{BLANK}$  has elapsed. During  $t_{RETRY}$  time, the switch remains off. Once  $t_{RETRY}$  has elapsed, the switch is turned back on again. If the fault still exists, the cycle is repeated and  $\overline{FLAG}$  (or  $\overline{FWD}$ ) pin remains asserted. If the overcurrent condition is resolved, the switch stays on.

The autoretry feature reduces system power in case of overcurrent or short-circuit conditions. When the switch is on during  $t_{BLANK}$  time, the supply current is held at the current limit. During  $t_{RETRY}$  time, there is no current through the switch. Thus, output current is much less than the programmed current limit. Calculate the average output current using the following equation:

$$I_{LOAD} = I_{LIM} \left[ \frac{t_{BLANK}}{t_{RETRY} + t_{BLANK}} \right]$$

With a 40ms (typ)  $t_{BLANK}$  and 600ms (typ)  $t_{RETRY}$ , the duty cycle is 6.25%, resulting in a 93.75% power reduction when compared to the switch being on the entire time. [Figure 3](#) depicts typical behavior in the autoretry current-limit mode.

### Continuous Current Limit

In continuous current-limit mode, when current through the device reaches the current limit threshold, the device limits output current to the programmed current limit. The  $\overline{FLAG}$  (or  $\overline{FWD}$ ) pin asserts if overcurrent condition is present for  $t_{BLANK}$  and deasserts when the overload condition is removed. [Figure 4](#) depicts typical behavior in the continuous current-limit mode.

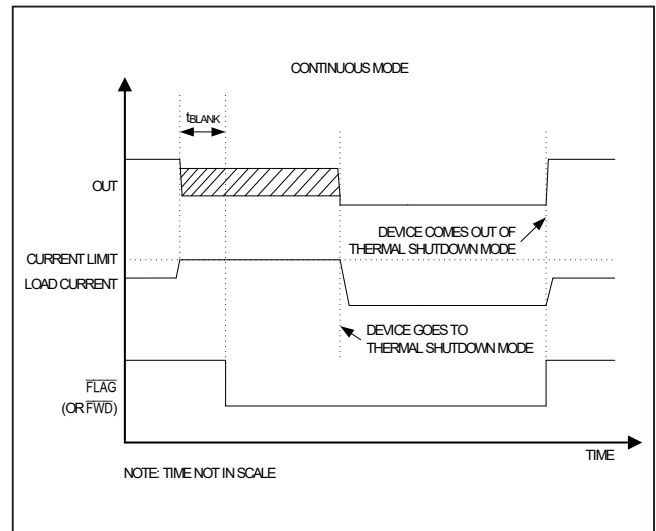

Figure 4. Continuous Fault-Timing Diagram

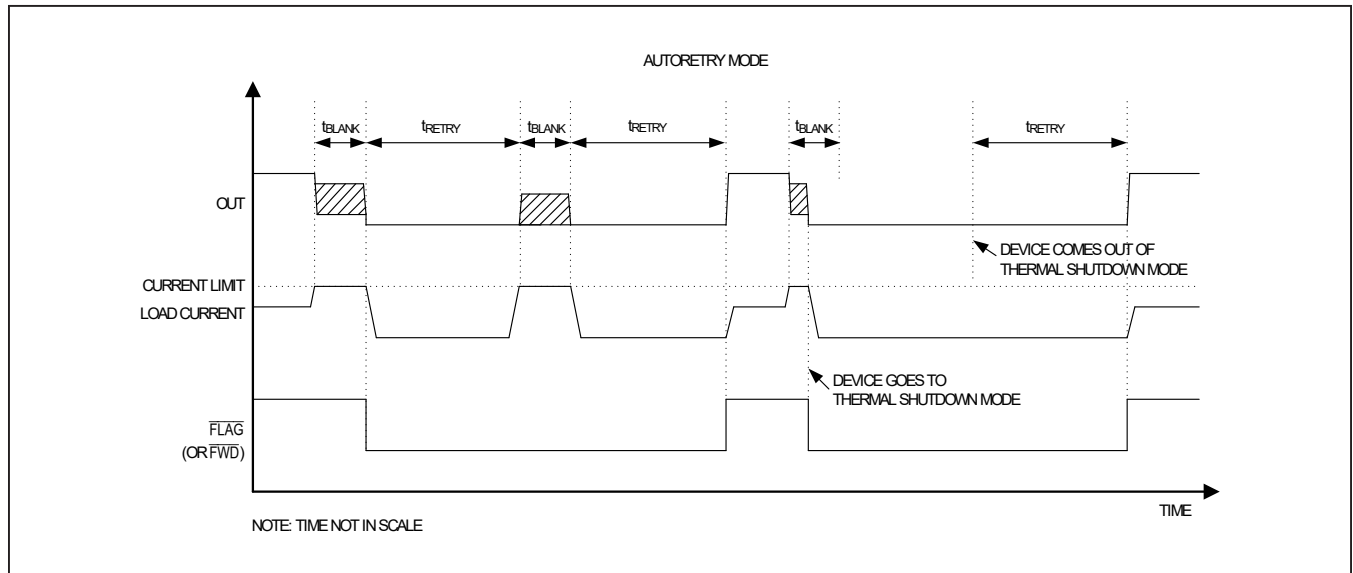

Figure 3. Autoretry Fault-Timing Diagram

### Latch-Off Current Limit

In latch-off current-limit mode, when current through the device reaches the current-limit threshold, the  $t_{BLANK}$  timer begins counting. The  $\overline{FLAG}$  (or  $\overline{FWD}$ ) pin asserts if an overcurrent condition is present for  $t_{BLANK}$ . The timer resets when the overcurrent condition disappears before  $t_{BLANK}$  has elapsed. The switch turns off and stays off if the overcurrent condition continues beyond  $t_{BLANK}$ . To reset the switch, either toggle the control logic (EN) or cycle the input voltage. [Figure 5](#) depicts typical behavior in latch-off current-limit mode.

### Reverse Current Protection

In MAX17612A and MAX17612C, the reverse current-protection feature is enabled and it prevents reverse current flow from OUT to IN pins. In MAX17612B, the reverse current-protection feature is disabled, which allows reverse current flow from the OUT to IN pins. This feature is useful in applications with inductive loads.

In MAX17612A and MAX17612C devices, two different reverse-current features are implemented. A slow reverse-current condition is detected if  $(V_{IN} - V_{OUT}) < V_{RIBS}$  is present for reverse current-blocking debounce blanking time ( $t_{DEBRIB}$ ). Only the input NFET (Q1) is turned off and the  $\overline{FLAG}$  (or  $\overline{REV}$ ) pin is asserted while the output NFET (Q2) is kept on. During and after this

time, the device monitors the voltage difference between the OUT and IN pins to determine whether the reverse current is still present. Once the reverse current condition has been removed, Q1 is turned back on and the  $\overline{FLAG}$  (or  $\overline{REV}$ ) pin is deasserted. Q1 takes  $t_{Q1\_ON}$  (~100 $\mu$ s) time to turn on. [Figure 6](#) depicts typical behavior in slow reverse current conditions.

A fast reverse-current condition is detected if  $(V_{IN} - V_{OUT}) < V_{RIBF}$  is present for reverse current blocking fast response time ( $t_{RIB}$ ). Only the input NFET (Q1) is turned off and the  $\overline{FLAG}$  (or  $\overline{REV}$ ) pin is asserted while the output NFET (Q2) is kept on. During and after this time, the device monitors the voltage difference between the OUT and IN pins to determine whether the reverse current is still present. Once the reverse current condition has been removed, Q1 is turned back on and the  $\overline{FLAG}$  (or  $\overline{REV}$ ) pin is deasserted. Q1 takes  $t_{Q1\_ON}$  (~100 $\mu$ s) time to turn on. [Figure 7](#) depicts typical behavior in fast reverse-current condition.

The device contains two reverse-current thresholds with slow (< 140 $\mu$ s) and fast (< 150ns) response time for reverse protection. The threshold values for slow reverse is 11mV (typ) whereas for fast reverse, it is 105mV (typ). This feature results in robust operation in a noisy environments, while still delivering fast protection for severe fault, such as input short-circuit or hot plug-in at the OUT pins.

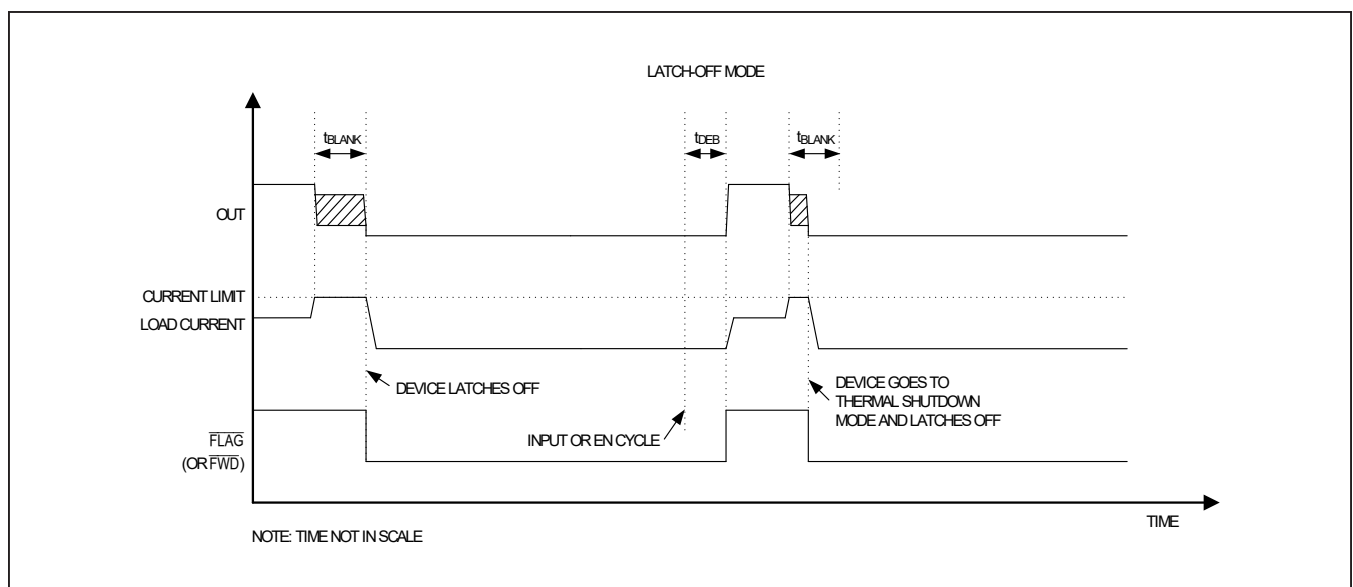

Figure 5. Latch-Off Fault-Timing Diagram



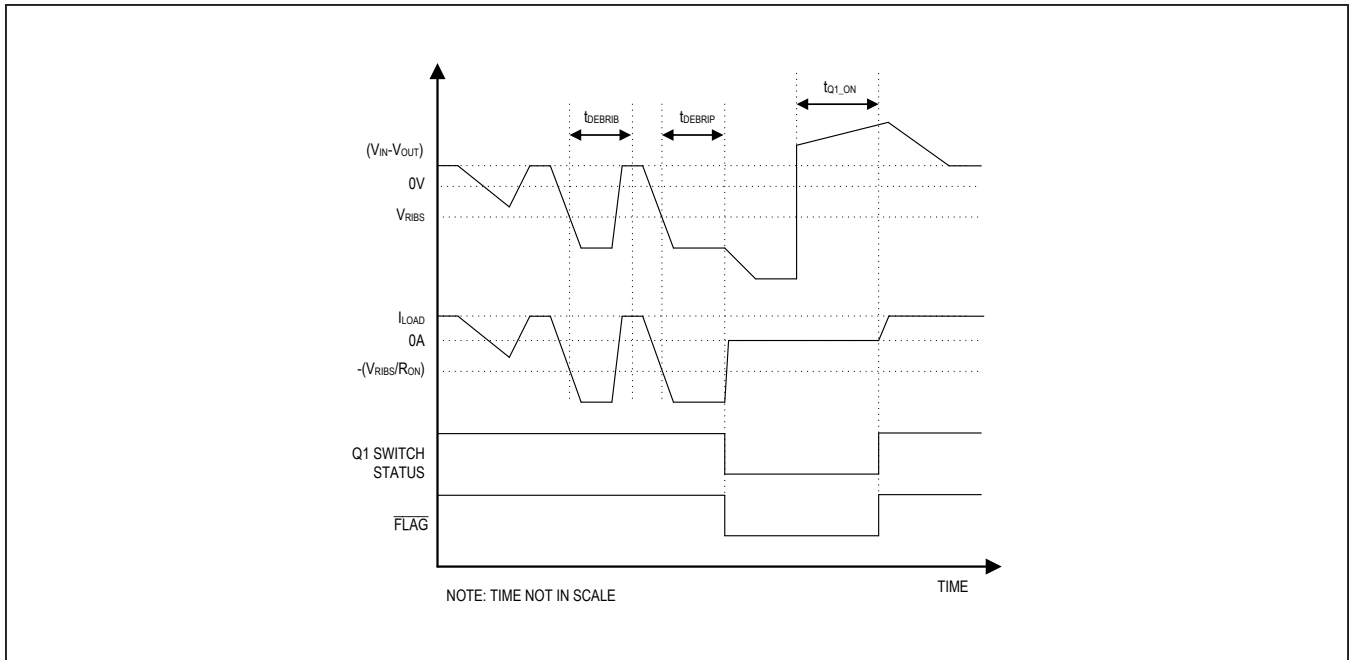

Figure 6. Slow Reverse-Current Fault-Timing Diagram

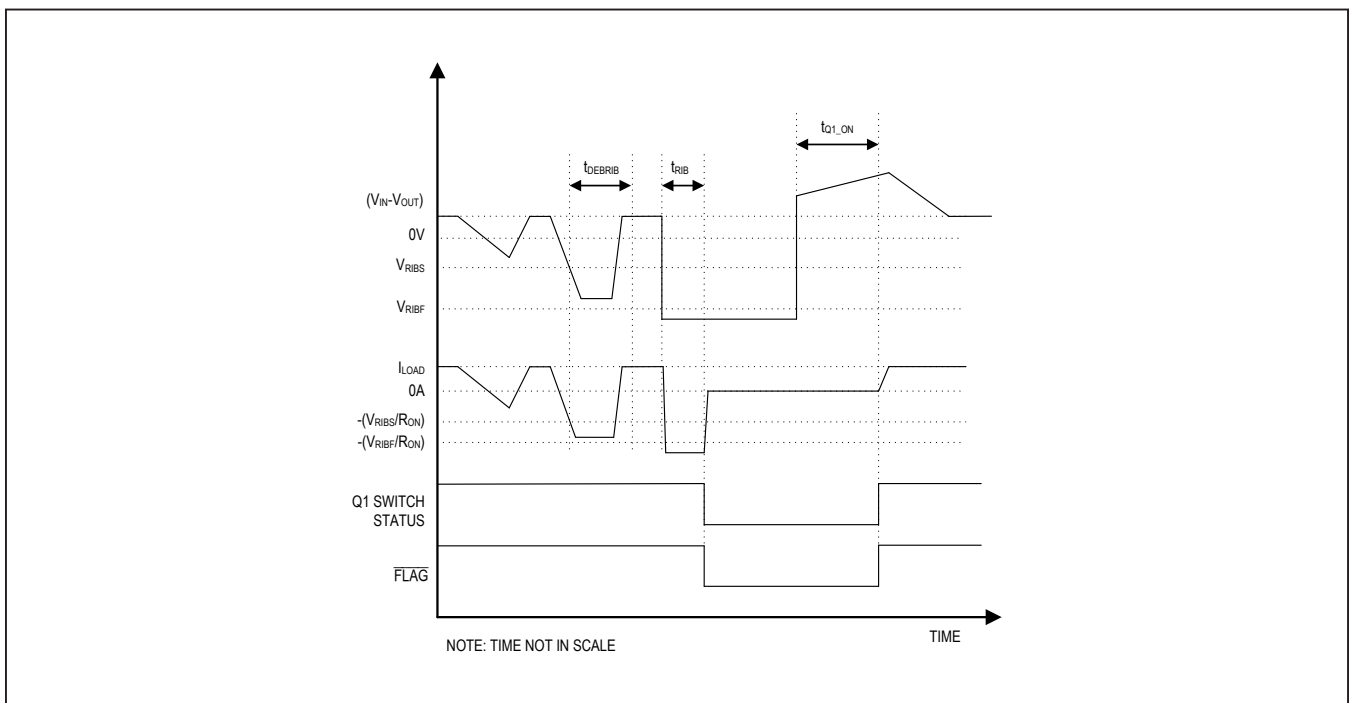

Figure 7. Fast Reverse-Current Fault-Timing Diagram

## MAX17612A/MAX17612B/ MAX17612C

## 4.5V to 60V, 250mA Current-Limiter with OV, UV, and Reverse Protection

### Fault Output

MAX17612A and MAX17612B devices have two open-drain fault outputs,  $\overline{\text{FLAG}}$  and  $\overline{\text{UVOV}}$ . They require external pullup resistors to a DC supply. The  $\overline{\text{FLAG}}$  pin goes low when any of the following conditions occur:

- Overcurrent duration exceeds blanking time.
- Reverse current is detected (MAX17612A only).
- Thermal shutdown is active.
- $R_{\text{SETI}}$  is less than 1k $\Omega$  (max).

The other fault output  $\overline{\text{UVOV}}$  goes low when input voltage falls below UVLO threshold or rises above OVLO threshold. Note that the UVLO fault has a debounce time of 16ms. This fault is removed 16ms after input voltage has crossed the UVLO threshold. This debounce also elapses only at powerup. As a consequence, the  $\overline{\text{UVOV}}$  pin fault signal is always asserted at power-up for at least 16ms.

The MAX17612C device has two open-drain fault outputs,  $\overline{\text{FWD}}$  and  $\overline{\text{REV}}$ . They require external pullup resistors to a DC supply.  $\overline{\text{FWD}}$  goes low when any of the following conditions occur:

- Overcurrent duration exceeds the blanking time.
- Thermal shutdown is active.
- $R_{\text{SETI}}$  is less than 1k $\Omega$  (max).

$\overline{\text{REV}}$  goes low when reverse current is detected.

### Thermal Shutdown Protection

The devices have a thermal shutdown feature to protect against overheating. The devices turn off and the  $\overline{\text{FLAG}}$  (or  $\overline{\text{FWD}}$ ) pin asserts when the junction temperature exceeds +160°C (typ). The devices exit thermal shutdown and resume normal operation after the junction temperature cools down by 28°C (typ), except when in latching mode, the devices remain latched off.

The thermal limit behaves similarly to the current limit. In autoretry mode, the thermal limit works with the autoretry timer. When the junction temperature falls below the falling thermal-shutdown threshold, devices turn on after the retry time. In latch-off mode, the devices latch off until power or EN is cycled. In continuous mode, the devices only disable while the temperature is over the limit. There is no blanking time for thermal protection. [Figure 3](#), [Figure 4](#), and [Figure 5](#) depict typical behavior under different current limit modes.

### Applications Information

#### IN Capacitor

A 0.47 $\mu\text{F}$  capacitor from the IN pin to GND is recommended to hold input voltage during sudden load-current changes.

#### Hot Plug-In at IN Terminal

In many system powering applications, an input-filtering capacitor is required to lower radiated emission and enhance ESD capability. In hot plug-in applications, parasitic cable inductance along with the input capacitor causes overshoot and ringing when a live power cable is connected to the input terminal.

This effect causes the protection device to see almost twice the applied voltage. A transient voltage suppressor (TVS) is often used in industrial applications to protect the system from these conditions. A TVS that is capable of limiting surge voltage to maximum 60V shall be placed close to the input terminal for enhanced protection. The maximum tolerated slew rate at the IN pins is 100V/ $\mu\text{s}$ .

#### Input Hard Short to Ground

In many system applications, an input short-circuit protection is required. The MAX17612A and MAX17612C devices detect reverse current entering at the OUT pin and flowing out of the IN pin and turn off the internal FETs. The magnitude of the reverse current depends on the inductance of input circuitry and any capacitance installed near the IN pins.

The devices can be damaged in case  $V_{\text{IN}}$  goes so negative that  $(V_{\text{OUT}} - V_{\text{IN}}) > 60\text{V}$ .

#### OUT Capacitor

The maximum capacitive load ( $C_{\text{MAX}}$ ) that can be connected is a function of current-limit setting ( $I_{\text{LIM}}$  in mA), the blanking time ( $t_{\text{BLANK}}$  in ms) and the input voltage.  $C_{\text{MAX}}$  is calculated using the following relationship:

$$C_{\text{MAX}}(\mu\text{F}) = \frac{I_{\text{LIM}}(\text{mA}) \times t_{\text{BLANK}}(\text{TYP})(\text{ms})}{V_{\text{IN}}(\text{V})}$$

For example, for  $V_{\text{IN}} = 24\text{V}$ ,  $t_{\text{BLANK}}(\text{TYP}) = 40\text{ms}$ , and  $I_{\text{LIM}} = 250\text{mA}$ ,  $C_{\text{MAX}}$  is 416 $\mu\text{F}$ .

Output capacitor values in excess of  $C_{\text{MAX}}$  can trigger false overcurrent conditions. Note that the above expression assumes no load current is drawn from the OUT pins. Any load current drawn would offset the capacitor charging current resulting in a longer charging period; hence, the possibility of a false overcurrent condition.

# MAX17612A/MAX17612B/ MAX17612C

# 4.5V to 60V, 250mA Current-Limiter with OV, UV, and Reverse Protection

## Hot Plug-In at OUT Terminal

In some applications, there might be a possibility of applying an external voltage at the OUT terminal of the devices with or without the presence of an input voltage. During these conditions, devices detect any reverse current entering at the OUT pin and flowing out of the IN pin and turn off the internal FETs. Parasitic cable inductance along with input and output capacitors, cause overshoot and ringing when an external voltage is applied at the OUT terminal. This causes the protection devices to see up to twice the applied voltage, which can damage the devices. It is recommended to maintain overvoltages such that the voltages at the pins do not exceed the absolute maximum ratings. The maximum tolerated slew rate at OUT pins is 100V/μs.

## Output Freewheeling Diode for Inductive Hard Short to Ground

In applications that require protection from a sudden short to ground with an inductive load or a long cable, a schottky diode between the OUT terminal and ground is recommended. This is to prevent a negative spike on the OUT due to the inductive kickback during a short-circuit event.

## Layout and Thermal Dissipation

To optimize the switch response time to output short-circuit conditions, it is very important to keep all traces as short as possible to reduce the effect of undesirable parasitic inductance. Place input and output capacitors as close as possible to the device (no more than 5mm). IN and OUT must be connected with wide short traces to the power bus. During normal operation, the power dissipation is small and the package temperature change is minimal.

Power dissipation under steady-state normal operation is calculated as:

$$P_{(SS)} = I_{OUT}^2 \times R_{ON}$$

Refer to the [Electrical Characteristics](#) table and [Typical Operating Characteristics](#) for  $R_{ON}$  values at various operating temperatures.

If the output is continuously shorted to ground at the maximum supply voltage, the switches with the autoretry option do not cause thermal shutdown detection to trip. Power dissipation in the devices operating in autoretry mode is calculated using the following equation:

$$P_{(MAX)} = \frac{V_{IN(MAX)} \times I_{OUT(MAX)} \times t_{BLANK}}{t_{RETRY} + t_{BLANK}}$$

Attention must be given to continuous current-limit mode when the power dissipation during a fault condition can cause the device to reach the thermal-shutdown threshold. Thermal vias from the exposed pad to ground plane are highly recommended to increase the system thermal capacitance while reducing the thermal resistance to the ambient.

## ESD Protection

The devices are specified for ±15kV (HBM) ESD on IN when IN is bypassed to ground with a 0.47μF, low-ESR ceramic capacitor. No capacitor is required for ±2kV (HBM) (typ) ESD on IN. All the pins have a ±2kV (HBM) typical ESD protection. [Figure 8](#) shows the HBM, and [Figure 9](#) shows the current waveform it generates when discharged into low impedance. This model consists of a 100pF capacitor charged to the ESD voltage of interest, which is then discharged into the device through a 1.5kΩ resistor.

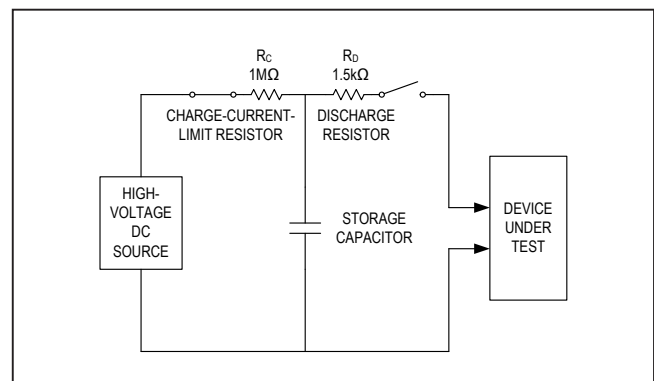

Figure 8. Human Body ESD Test Model

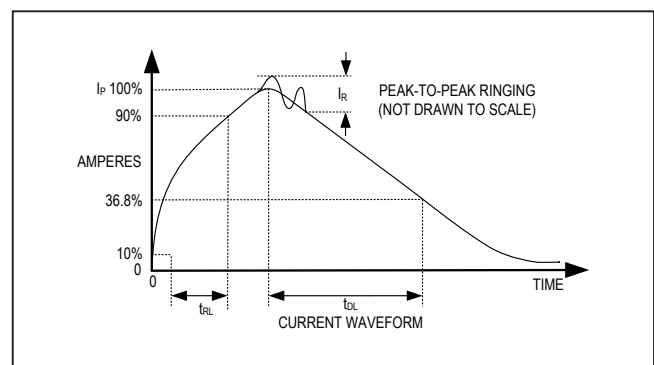

Figure 9. Human Body Current Waveform

MAX17612A/MAX17612B/  
MAX17612C

4.5V to 60V, 250mA Current-Limiter with  
OV, UV, and Reverse Protection

## Ordering Information

PART	TEMP RANGE	PIN PACKAGE	FEATURE DIFFERENCES
MAX17612AATB+T	-40°C to +125°C	10 TDFN-EP*	OV, UV, Reverse Voltage Protection
MAX17612BATB+T	-40°C to +125°C	10 TDFN-EP*	OV, UV
MAX17612CATB+T	-40°C to +125°C	10 TDFN-EP*	Reverse Voltage Protection

+Denotes a lead(Pb)-free/RoHS-compliant package.

T Denotes tape-and-reel.

\*EP = Exposed Pad

MAX17612A/MAX17612B/  
MAX17612C

4.5V to 60V, 250mA Current-Limiter with  
OV, UV, and Reverse Protection

## Revision History

REVISION NUMBER	REVISION DATE	DESCRIPTION	PAGES CHANGED
0	6/18	Initial release	—
.1		Corrected typo	1

For pricing, delivery, and ordering information, please contact Maxim Direct at 1-888-629-4642, or visit Maxim Integrated's website at [www.maximintegrated.com](http://www.maximintegrated.com).

*Maxim Integrated cannot assume responsibility for use of any circuitry other than circuitry entirely embodied in a Maxim Integrated product. No circuit patent licenses are implied. Maxim Integrated reserves the right to change the circuitry and specifications without notice at any time. The parametric values (min and max limits) shown in the Electrical Characteristics table are guaranteed. Other parametric values quoted in this data sheet are provided for guidance.*