

SIOV metal oxide varistors

Leaded varistors, SNF high operating temperature varistors, SNF AdvanceD-MP, SNF14 series

Series/Type: B722*

Date: January 2018

© EPCOS AG 2018. Reproduction, publication and dissemination of this publication, enclosures hereto and the information contained therein without EPCOS' prior express consent is prohibited.

EPCOS AG is a TDK Group Company.

SNF AdvanceD-MP, SNF14 series
Construction

- Round varistor element, leaded
- Coating: silicon resin, flame-retardant to UL 94 V-0
- Terminals: tinned wire

Features

- Wide operating voltage range 130 ... 550 V_{RMS}
- All types duty cycle @ 6 kV/ 3 kA = >10 pulses, according to IEC 62368-1; G.8.2 and IEC 60950-1; Annex Q, IEC 61051-2
- All types I_n @ 3 kA = >15 impulses according to UL 1449, 4th edition surge current generator (8/20 μs), type 5 listed
- Enhanced resistance against heat and humidity 85 °C, 85% r.h., 0.85 · V_v (1 mA), 1000 h for use in harsh environments
- Multiple pulse handling capability

Approvals

- UL
- CSA
- VDE
- CQC
- IEC

Options

- Types qualified to AEC-Q200 available in SNF automotive series or upon request
- Special insulation types upon request

Delivery mode

- Bulk (standard)

General technical data

Climatic category	to IEC 60068-1	40/125/56	
Operating temperature	to IEC 61051	-40 ... +125	°C
Storage temperature		-40 ... +150	°C
Electric strength	to IEC 61051	≥ 2.5	kV _{RMS}
Insulation resistance	to IEC 61051	≥ 100	MΩ



Electrical specifications and ordering codes
Maximum ratings ($T_A = 125\text{ °C}$)

Ordering code	Type (untaped) SIOV-	V_{RMS}	V_{DC}	i_{max} (8/20 μ s) 1 time	I_n ¹⁾ (8/20 μ s) 15 times	W_{max} (2 ms)	P_{max}
		V	V	A	A	J	W
B72214U2131K502	SNF14K130E2S5K1	130	170	6000	3000	60.0	0.60
B72214U2141K502	SNF14K140E2S5K1	140	180	6000	3000	65.0	0.60
B72214U2151K502	SNF14K150E2S5K1	150	200	6000	3000	70.0	0.60
B72214U2171K502	SNF14K175E2S5K1	175	225	6000	3000	80.0	0.60
B72214U2211K502	SNF14K210E2S5K1	210	270	6000	3000	95.0	0.60
B72214U2231K502	SNF14K230E2S5K1	230	300	6000	3000	105.0	0.60
B72214U2251K502	SNF14K250E2S5K1	250	320	6000	3000	115.0	0.60
B72214U2271K502	SNF14K275E2S5K1	275	350	6000	3000	130.0	0.60
B72214U2301K502	SNF14K300E2S5K1	300	385	6000	3000	140.0	0.60
B72214U2321K502	SNF14K320E2S5K1	320	420	6000	3000	150.0	0.60
B72214U2351K502	SNF14K350E2S5K1	350	460	6000	3000	165.0	0.60
B72214U2381K502	SNF14K385E2S5K1	385	505	6000	3000	180.0	0.60
B72214U2421K502	SNF14K420E2S5K1	420	560	6000	3000	190.0	0.60
B72214U2461K502	SNF14K460E2S5K1	460	615	6000	3000	200.0	0.60
B72214U2511K502	SNF14K510E2S5K1	510	670	6000	3000	200.0	0.60
B72214U2551K502	SNF14K550E2S5K1	550	745	6000	3000	220.0	0.60

¹⁾ **Note:** Nominal discharge current I_n , according to UL 1449, 4th edition.

Characteristics ($T_A = 25\text{ °C}$)

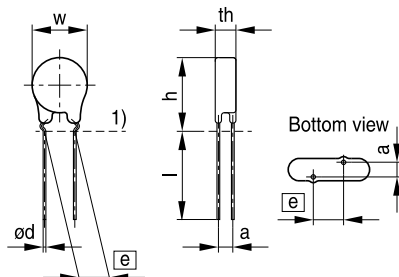
Ordering code	Type (untaped) SIOV-	V_v	ΔV_v	$V_{c,max}$	i_c	C_{typ}
		(1 mA) V	(1 mA) %	(i_c) V	A	(1 kHz) pF
B72214U2131K502	SNF14K130E2S5K1	205	± 10	340	50.0	1100
B72214U2141K502	SNF14K140E2S5K1	220	± 10	360	50.0	1000
B72214U2151K502	SNF14K150E2S5K1	240	± 10	395	50.0	900
B72214U2171K502	SNF14K175E2S5K1	270	± 10	455	50.0	800
B72214U2211K502	SNF14K210E2S5K1	330	± 10	545	50.0	690
B72214U2231K502	SNF14K230E2S5K1	360	± 10	595	50.0	630
B72214U2251K502	SNF14K250E2S5K1	390	± 10	650	50.0	580
B72214U2271K502	SNF14K275E2S5K1	430	± 10	710	50.0	530
B72214U2301K502	SNF14K300E2S5K1	470	± 10	775	50.0	485
B72214U2321K502	SNF14K320E2S5K1	510	± 10	840	50.0	445
B72214U2351K502	SNF14K350E2S5K1	560	± 10	910	50.0	410
B72214U2381K502	SNF14K385E2S5K1	620	± 10	1025	50.0	390
B72214U2421K502	SNF14K420E2S5K1	680	± 10	1120	50.0	355
B72214U2461K502	SNF14K460E2S5K1	750	± 10	1240	50.0	320
B72214U2511K502	SNF14K510E2S5K1	820	± 10	1355	50.0	300
B72214U2551K502	SNF14K550E2S5K1	910	± 10	1500	50.0	265

Dimensional drawings

1) Seating plane to IEC 60717

VAR0727-N-E

Please note: Paint legs may have cracks or chips due to the mechanical forces acting on the wires, but this does not affect the performance of the component.

Dimensions

Ordering code	[e] ±1 mm	a (typical) mm	w _{max} mm	th _{max} mm	h _{max} mm	l _{min} mm	d ±0.05 mm
B72214U2131K502	7.5	2.0	18.0	7.7	24.5	25.0	0.8
B72214U2141K502	7.5	2.1	18.0	7.8	24.5	25.0	0.8
B72214U2151K502	7.5	2.2	18.0	7.9	24.5	25.0	0.8
B72214U2171K502	7.5	2.4	18.0	8.1	24.5	25.0	0.8
B72214U2211K502	7.5	2.7	18.0	8.4	24.5	25.0	0.8
B72214U2231K502	7.5	2.9	18.0	8.6	24.5	25.0	0.8
B72214U2251K502	7.5	3.0	18.0	8.7	24.5	25.0	0.8
B72214U2271K502	7.5	3.2	18.0	8.9	24.5	25.0	0.8
B72214U2301K502	7.5	3.5	18.0	9.1	24.5	25.0	0.8
B72214U2321K502	7.5	3.7	18.0	9.3	24.5	25.0	0.8
B72214U2351K502	7.5	3.9	18.5	9.7	25.0	25.0	0.8
B72214U2381K502	7.5	4.2	18.5	10.7	25.0	25.0	0.8
B72214U2421K502	7.5	4.5	18.5	11.2	25.0	25.0	0.8
B72214U2461K502	7.5	4.7	18.5	11.5	25.0	25.0	0.8
B72214U2511K502	7.5	4.8	19.0	11.9	25.0	25.0	0.8
B72214U2551K502	7.5	4.9	19.0	12.4	25.0	25.0	0.8

Weight

Nominal diameter mm	V _{RMS} V	Weight g
14	130 ... 550	3.5 ... 5.5

The weight of varistors in between these voltage classes can be interpolated.



Leaded varistors, SNF high operating temperature

B722*

SNF AdvanceD-MP, SNF14 series

Reliability data

Test	Test methods/ conditions	Requirement
Varistor voltage	The voltage between two terminals with the specified measuring current applied is called V_V (1 mA _{DC} @ 0.2 ... 2 s).	To meet the specified value
Clamping voltage	The maximum voltage between two terminals with the specified standard impulse current (8/20 μ s) applied.	To meet the specified value
Endurance at upper category temperature	1000 h at UCT After having continuously applied the maximum allowable AC voltage at UCT ± 2 °C for 1000 h, the specimen shall be stored at room temperature and normal humidity for 1 to 2 h. Thereafter, the change of V_V shall be measured.	$ \Delta V/V$ (1 mA) $\leq 10\%$
Surge current derating, 8/20 μ s	10 surge currents (8/20 μ s), unipolar, interval 30 s, amplitude corresponding to derating curve for 10 impulses at 20 μ s	$ \Delta V/V$ (1 mA) $\leq 10\%$ (measured in direction of surge current) No visible damage
Surge current derating, 2 ms	10 surge currents (2 ms), unipolar, interval 120 s, amplitude corresponding to derating curve for 10 impulses at 2 ms	$ \Delta V/V$ (1 mA) $\leq 10\%$ (measured in direction of surge current) No visible damage
Electric strength	IEC 61051-1, test 4.9.2 Metal balls method, 2500 V _{RMS} , 60 s The varistor is placed in a container holding 1.6 ± 0.2 mm diameter metal balls such that only the terminations of the varistor are protruding. The specified voltage shall be applied between both terminals of the specimen connected together and the electrode inserted between the metal balls.	No breakdown

Leaded varistors, SNF high operating temperature
B722*
SNF Advanced-MP, SNF14 series

Test	Test methods/ conditions	Requirement
Climatic sequence	<p>The specimen shall be subjected to:</p> <p>a) dry heat at UCT, 16 h, IEC 60068-2-2, test Ba</p> <p>b) damp heat, 1st cycle: 55 °C, 93% r. H., 24 h, IEC 60068-2-30, test Db</p> <p>c) cold, LCT, 2 h, IEC 60068-2-1, test Aa</p> <p>d) damp heat, additional 5 cycles: 55 °C/25 °C, 93% r. H., 24 h/cycle, IEC 60068-2-30, test Db.</p> <p>Then the specimen shall be stored at room temperature and normal humidity for 1 to 2 h.</p> <p>Thereafter, the change of V_V shall be measured. Thereafter, insulation resistance R_{ins} shall be measured at $V = 500$ V.</p>	$ \Delta V/V (1 \text{ mA}) \leq 10\%$ $R_{ins} \geq 100 \text{ M}\Omega$
Rapid change of temperature	IEC 60068-2-14, test Na, LCT/UCT, dwell time 10 min, 1000 cycles	$ \Delta V/V (1 \text{ mA}) \leq 5\%$ No visible damage
Damp heat	IEC 60068-2-78, test Cy 85 °C, 85% r. H., $0.85 * V_V (1 \text{ mA})$, 1000 h	$ \Delta V/V (1 \text{ mA}) \leq 10\%$ No visible damage
Solderability	<p>IEC 60068-2-20, test Ta, method 1 with modified conditions for lead-free solder alloys: 245 °C, 3 s:</p> <p>After dipping the terminals to a depth of approximately 3 mm from the body in a soldering bath of 245 °C for 3 s, the terminals shall be visually examined.</p>	<p>The inspection shall be carried out under adequate light with normal eyesight or with the assistance of a magnifier capable of giving a magnification of 4 to 10 times. The dipped surface shall be covered with a smooth and bright solder coating with no more than small amounts of scattered imperfections such as pinholes or un-wetted or de-wetted areas. These imperfections shall not be concentrated in one area.</p>

Leaded varistors, SNF high operating temperature
B722*
SNF AdvanceD-MP, SNF14 series

Test	Test methods/ conditions	Requirement
Resistance to soldering heat	IEC 60068-2-20, test Tb, method 1A, 260 °C, 10 s: Each lead shall be dipped into a solder bath having a temperature of 260 ± 5 °C to a point 2.0 to 2.5 mm from the body of the specimen, be held there for 10 ± 1 s and then be stored at room temperature and normal humidity for 1 to 2 h. The change of V_V shall be measured and the specimen shall be visually examined.	$ \Delta V/V (1 \text{ mA}) \leq 5\%$ No visible damage
Tensile strength	IEC 60068-2-21, test Ua1 After gradually applying the force specified below and keeping the unit fixed for 10 s, the terminal shall be visually examined for any damage. Force for wire diameter: 0.6 mm = 10 N 0.8 mm = 10 N 1.0 mm = 20 N	$ \Delta V/V (1 \text{ mA}) \leq 5\%$ No break of solder joint, no wire break
Vibration	IEC 60068-2-6, test Fc, method B4 Frequency range: 10 ... 55 Hz Amplitude: 0.75 mm or 98 m/s^2 Duration: 6 h ($3 \cdot 2$ h) Pulse: sine wave After repeatedly applying a single harmonic vibration according to the table above. The change of V_V shall be measured and the specimen shall be visually examined.	$ \Delta V/V (1 \text{ mA}) \leq 5\%$ No visible damage
Bump	IEC 60068-2-29, test Eb Pulse duration: 6 ms Max. acceleration: 400 m/s^2 Number of bumps: 4000 Pulse: half sine	$ \Delta V/V (1 \text{ mA}) \leq 5\%$ No visible damage
Fire hazard	IEC 60695-11-5 (needle flame test) Severity: vertical 10 s	5 s max.

Note:

UCT = Upper category temperature

LCT = Lower category temperature

 R_{ins} = Insulation resistance

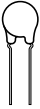

v/i characteristics

$v = f(i)$ - for explanation of the characteristics refer to "General technical information", 1.6.3
 A = Leakage current, B = Protection level } for worst-case varistor tolerances

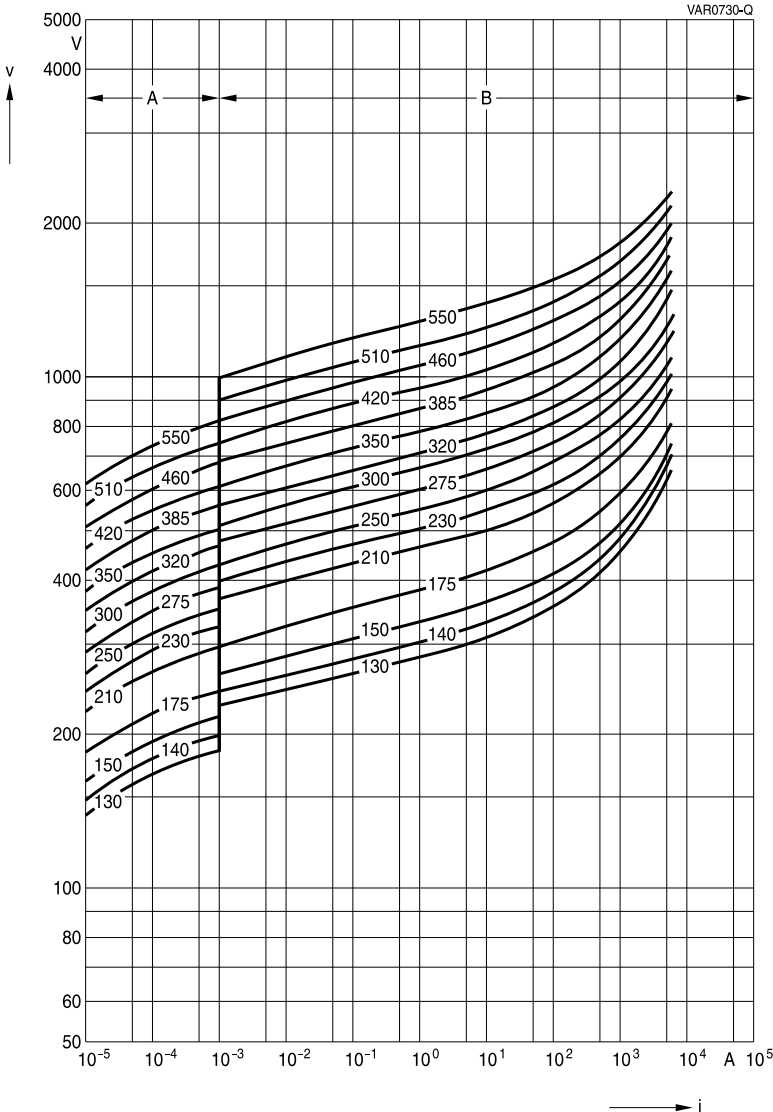

SIOV-SNF14 ... E2S5K1

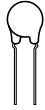

Derating curves

Maximum surge current $i_{max} = f(t_r, \text{pulse train})$

For explanation of the derating curves refer to "General technical information", section 1.8.1

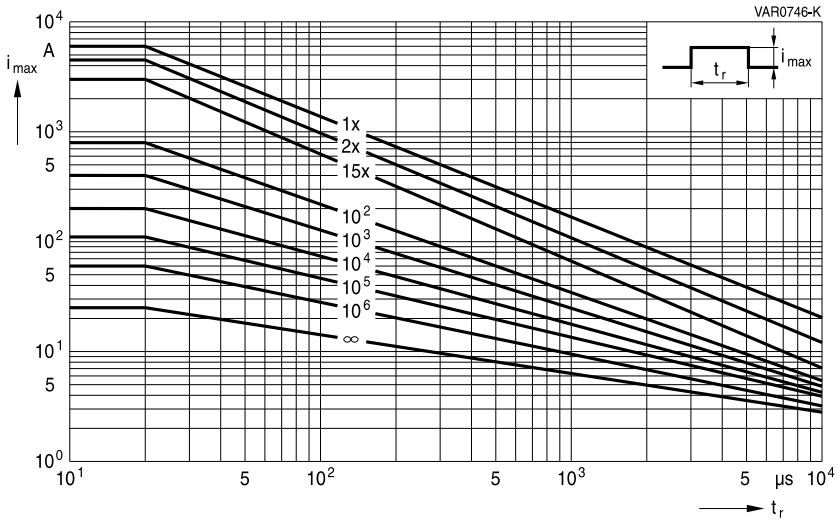

SIOV-SNF14K130 ... K460E2S5K1

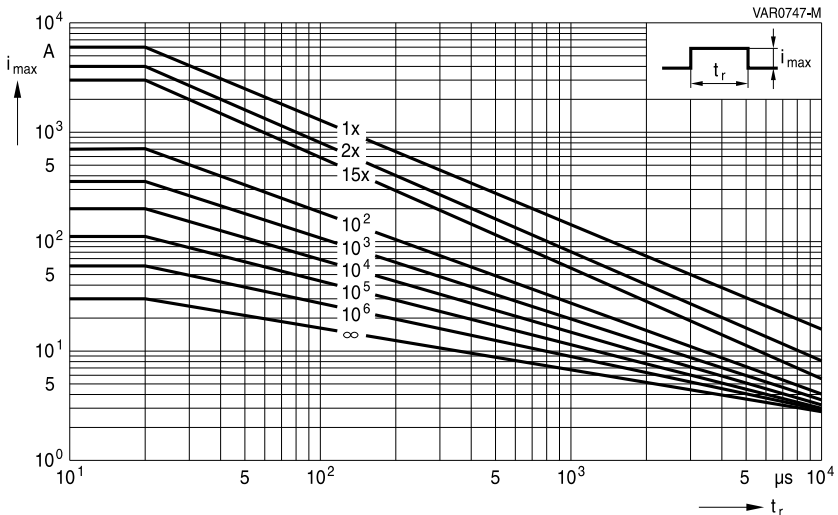

SIOV-SNF14K510 ... K550E2S5K1



Taping, packaging and lead configuration

1 EPCOS ordering code system

For leaded varistors

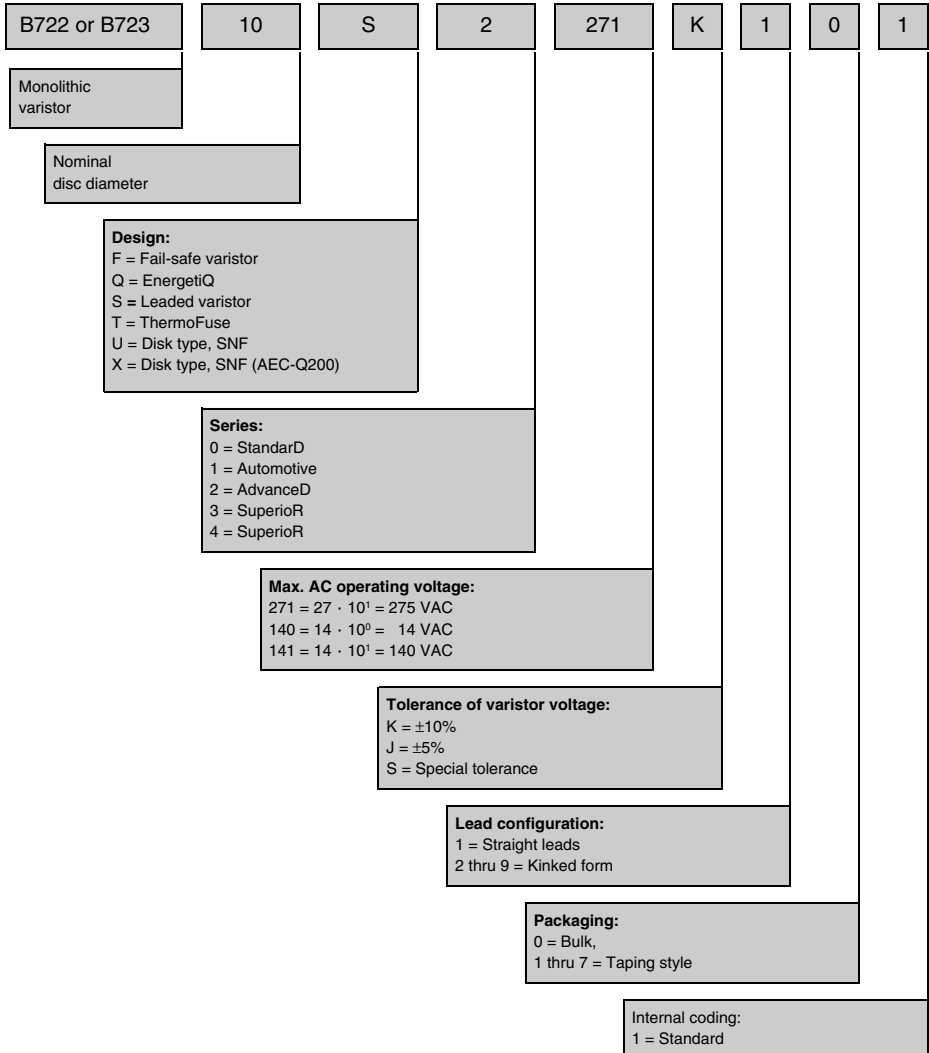

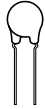

2 Taping and packaging of leaded varistors

Tape packaging for lead spacing \boxed{e} = 5 fully conforms to IEC 60286-2, while for lead spacings \boxed{e} = 7.5 and 10 the taping mode is based on this standard.

2.1 Taping in accordance with IEC 60286-2 for lead spacing 5.0 mm

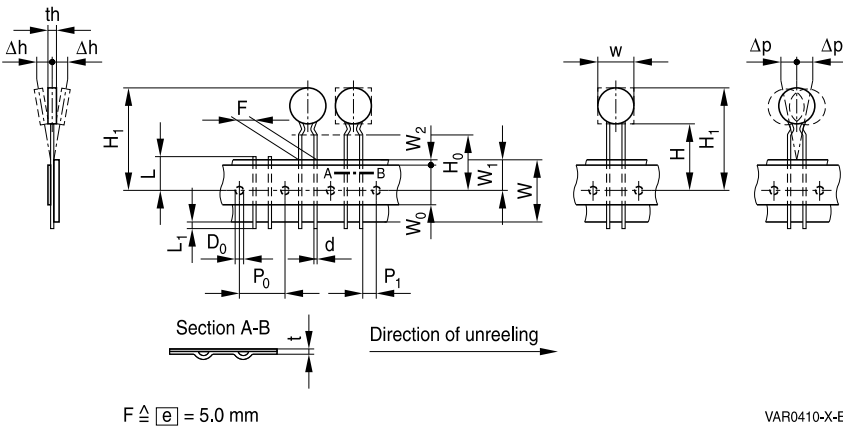

2.2 Taping based on IEC 60286-2 for lead spacing 7.5 and 10 mm

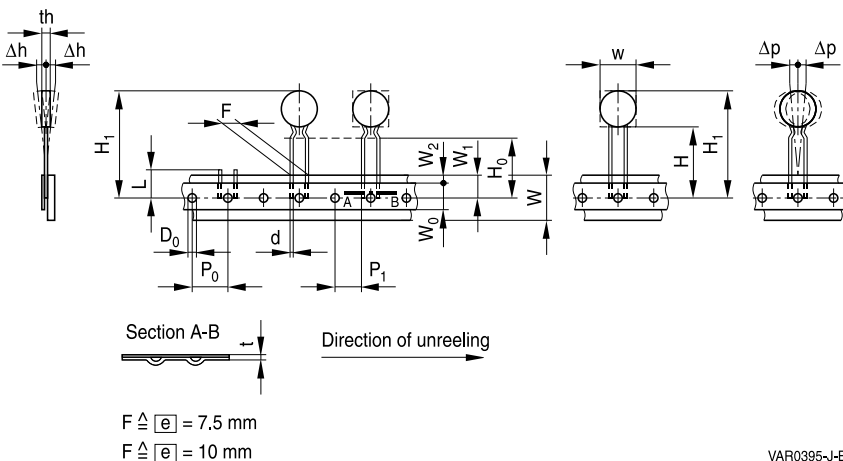

2.3 Tape dimensions (in mm)

Symbol	$e = 5.0$	Tolerance	$e = 7.5$	Tolerance	$e = 10.0$	Tolerance	Remarks
w		max.		max.		max.	see tables in each series under "Dimensions"
th		max.		max.		max.	
d	0.6	± 0.05	0.8	± 0.05	1.0	± 0.05	
P ₀	12.7	± 0.3	12.7 ¹⁾	± 0.3	12.7	± 0.3	± 1 mm/20 sprocket holes
P ₁	3.85	± 0.7	8.95	± 0.8	7.7	± 0.8	
F	5.0	$+0.6/-0.1$	7.5	± 0.8	10.0	± 0.8	measured at top of component body
Δh	0	± 2.0	depends on s		depends on s		
Δp	0	± 1.3	0	± 2.0	0	± 2.0	
W	18.0	± 0.5	18.0	± 0.5	18.0	± 0.5	Peel-off force ≥ 5 N
W ₀	5.5	min.	11.0	min.	11.0	min.	
W ₁	9.0	± 0.5	9.0	$+0.75/-0.5$	9.0	$+0.75/-0.5$	
W ₂	3.0	max.	3.0	max.	3.0	max.	
H	18.0	$+2.0/-0$	18.0	$+2.0/-0$	18.0	$+2.0/-0$	2) 3)
H ₀	16.0 (18.0)	± 0.5	16.0 (18.0)	± 0.5	16.0	± 0.5	
H ₁	32.2	max.	45.0	max.	45.0	max.	
D ₀	4.0	± 0.2	4.0	± 0.2	4.0	± 0.2	without lead
t	0.9	max.	0.9	max.	0.9	max.	
L	11.0	max.	11.0	max.	11.0	max.	
L ₁	0.5	max.					

1) Taping with P₀ = 15.0 mm upon request

2) Applies only to uncrimped types

3) Applies only to crimped types (H₀ = 18 upon request)



2.4 Taping mode

Example: B72210S0271K1 5 1
|
Digit 14

Digit 14	Taping mode	Reel type	Seating plane height H_0 for crimped types mm	Seating plane height H for uncrimped types mm	Pitch distance P_0 mm
0	—	Bulk	—	—	—
1	G	I	16	18	12.7
2	G2	I	18	—	12.7
3	G3	II	16	18	12.7
4	G4	II	18	—	12.7
5	G5	III	16	18	12.7
6	GA	Ammo pack	16	18	12.7
7	G2A	Ammo pack	18	—	12.7

Internal coding for special taping

G6	III	18	—	12.7
G10	II	16	18	15.0
G11	II	18	—	15.0
G10A	Ammo pack	16	18	15.0
G11A	Ammo pack	18	—	15.0

2.5 Reel dimension

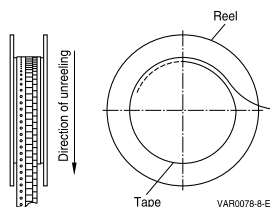
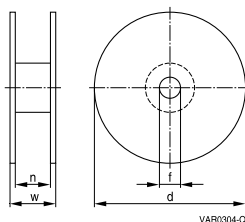

Dimensions (in mm)

Reel type	d	f	n	w
I	360 max.	31 ±1	approx. 45	54 max.
II	360 max.	31 ±1	approx. 55	64 max.
III	500 max.	23 ±1	approx. 59	72 max.

If reel type III is not compatible with insertion equipment because of its large diameter, nominal disk diameter 10 mm and 14 mm can be supplied on reel II upon request (taping mode G3).



2.6 Ammo pack dimensions

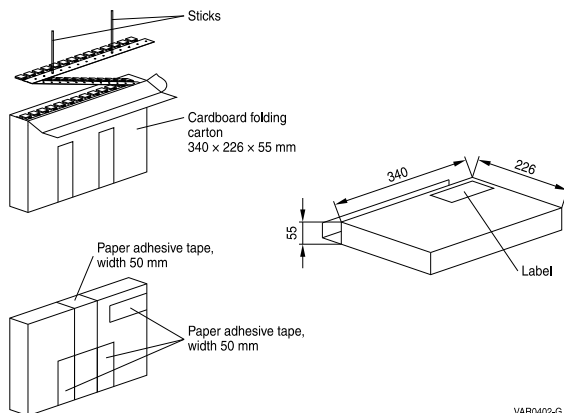

VAR0402-G

3 Lead configuration

Straight leads are standard for disk varistors. Other lead configurations as crimp style or customer-specific lead wire length according to 3.1, 3.2, 3.3 and 3.4 are optional. Crimped leads (non-standard) are differently crimped for technical reasons; the individual crimp styles are denoted by consecutive numbers (S, S2 through S5) as shown in the dimensional drawings below.

The crimp styles of the individual types can be seen from the type designation in the ordering tables.

3.1 Crimp style mode

Example: B72210S0271K **5** 01

Digit 13

Digit 13 of ordering code	Crimp style	Figure
1	Standard, straight leads	1
2	S2	2
3	S3	3
5	S5	4
Available upon request		
Internal coding	—	5



3.2 Standard leads and non-standard crimp styles

The basic dimensions in figure 1 to 5 are valid for types with either round or square (EnergetiQ series) component head.

Standard, straight leads

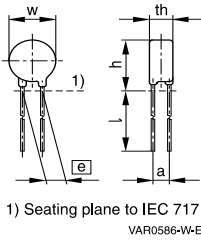

Figure 1

Non-standard, crimp style S2

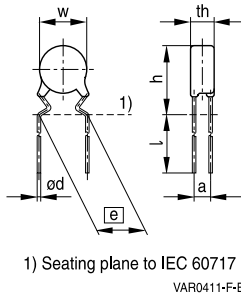

Figure 2

Non-standard, crimp style S3

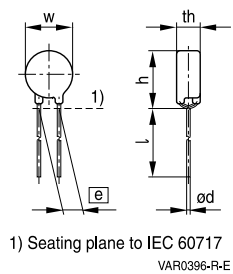

Figure 3

Non-standard, crimp style S5

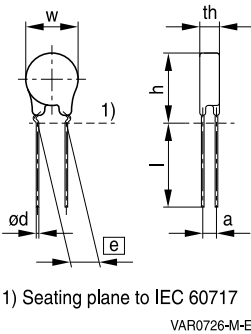

Figure 4



3.3 Trimmed leads (non-standard)

Varistors with cut leads available upon request.

Lead length tolerances:

Straight leads ± 0.8 mm

Crimped leads ± 0.5 mm

Minimum lead length 3.0 mm

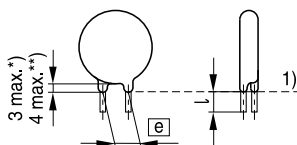

1) Seating plane to IEC 60717

*) For round component head

***) For EnergetiQ series, square component head

VAR0642-U-E

Figure 5



Cautions and warnings

General

1. EPCOS metal oxide varistors are designed for specific applications and should not be used for purposes not identified in our specifications, application notes and data books unless otherwise agreed with EPCOS during the design-in-phase.
2. Ensure suitability of SIOVs through reliability testing during the design-in phase. SIOVs should be evaluated taking into consideration worst-case conditions.
3. For applications of SIOVs in line-to-ground circuits based on various international and local standards there are restrictions existing or additional safety measures required.

Storage

1. Store SIOVs only in original packaging. Do not open the package prior to processing.
2. Recommended storage conditions in original packaging:
 Storage temperature: $-25\text{ }^{\circ}\text{C} \dots +45\text{ }^{\circ}\text{C}$,
 Relative humidity: $<75\%$ annual average,
 $<95\%$ on maximum 30 days a year.
 Dew precipitation: is to be avoided.
3. Avoid contamination of an SIOV's during storage, handling and processing.
4. Avoid storage of SIOVs in harmful environments that can affect the function during long-term operation (examples given under operation precautions).
5. The SIOV type series should be soldered after shipment from EPCOS within the time specified:

SIOV-S, -Q, -LS, -B, -SNF	24 months
ETFV/ T series, -CU	12 months.

Handling

1. SIOVs must not be dropped.
2. Components must not be touched with bare hands. Gloves are recommended.
3. Avoid contamination of the surface of SIOV electrodes during handling, be careful of the sharp edge of SIOV electrodes.

Soldering (where applicable)

1. Use rosin-type flux or non-activated flux.
2. Insufficient preheating may cause ceramic cracks.
3. Rapid cooling by dipping in solvent is not recommended.
4. Complete removal of flux is recommended.
5. Temperatures of all preheat stages and the solder bath must be strictly controlled especially for T series (T14 and T20).



Mounting

1. Potting, sealing or adhesive compounds can produce chemical reactions in the SIOV ceramic that will degrade the component's electrical characteristics.
2. Overloading SIOVs may result in ruptured packages and expulsion of hot materials. For this reason SIOVs should be physically shielded from adjacent components.

Operation

1. Use SIOVs only within the specified temperature operating range.
2. Use SIOVs only within the specified voltage and current ranges.
3. Environmental conditions must not harm SIOVs. Use SIOVs only in normal atmospheric conditions. Avoid use in deoxidizing gases (chlorine gas, hydrogen sulfide gas, ammonia gas, sulfuric acid gas etc), corrosive agents, humid or salty conditions. Contact with any liquids and solvents should be prevented.

Display of ordering codes for EPCOS products

The ordering code for one and the same EPCOS product can be represented differently in data sheets, data books, other publications, on the EPCOS website, or in order-related documents such as shipping notes, order confirmations and product labels. **The varying representations of the ordering codes are due to different processes employed and do not affect the specifications of the respective products.** Detailed information can be found on the Internet under www.epcos.com/orderingcodes



Symbols and terms

Symbol	Term
C	Capacitance
C_{typ}	Typical capacitance
i	Current
i_c	Current at which $V_{c, max}$ is measured
I_{leak}	Leakage current
i_{max}	Maximum surge current (also termed peak current)
I_{max}	Maximum discharge current
I_n	Nominal discharge current to UL 1449
LCT	Lower category temperature
L_{typ}	Typical inductance
P_{max}	Maximum average power dissipation
R_{ins}	Insulation resistance
R_{min}	Minimum resistance
T_A	Ambient temperature
t_r	Duration of equivalent rectangular wave
UCT	Upper category temperature
v	Voltage
V_{clamp}	Clamping voltage
$V_{c, max}$	Maximum clamping voltage at specified current i_c
V_{DC}	DC operating voltage
V_{jump}	Maximum jump start voltage
V_{max}	Maximum voltage
V_{op}	Operating voltage
V_{RMS}	AC operating voltage, root-mean-square value
$V_{RMS, op, max}$	Root-mean-square value of max. DC operating voltage incl. ripple current
V_{surge}	Super imposed surge voltage
V_V	Varistor voltage
ΔV_V	Tolerance of varistor voltage
W_{LD}	Maximum load dump
W_{max}	Maximum energy absorption
e	Lead spacing

All dimensions are given in mm.

The commas used in numerical values denote decimal points.

Important notes

The following applies to all products named in this publication:

1. Some parts of this publication contain **statements about the suitability of our products for certain areas of application**. These statements are based on our knowledge of typical requirements that are often placed on our products in the areas of application concerned. We nevertheless expressly point out **that such statements cannot be regarded as binding statements about the suitability of our products for a particular customer application**. As a rule we are either unfamiliar with individual customer applications or less familiar with them than the customers themselves. For these reasons, it is always ultimately incumbent on the customer to check and decide whether a product with the properties described in the product specification is suitable for use in a particular customer application.
2. We also point out that **in individual cases, a malfunction of electronic components or failure before the end of their usual service life cannot be completely ruled out in the current state of the art, even if they are operated as specified**. In customer applications requiring a very high level of operational safety and especially in customer applications in which the malfunction or failure of an electronic component could endanger human life or health (e.g. in accident prevention or life-saving systems), it must therefore be ensured by means of suitable design of the customer application or other action taken by the customer (e.g. installation of protective circuitry or redundancy) that no injury or damage is sustained by third parties in the event of malfunction or failure of an electronic component.
3. **The warnings, cautions and product-specific notes must be observed.**
4. In order to satisfy certain technical requirements, **some of the products described in this publication may contain substances subject to restrictions in certain jurisdictions (e.g. because they are classed as hazardous)**. Useful information on this will be found in our Material Data Sheets on the Internet (www.tdk-electronics.tdk.com/material). Should you have any more detailed questions, please contact our sales offices.
5. We constantly strive to improve our products. Consequently, **the products described in this publication may change from time to time**. The same is true of the corresponding product specifications. Please check therefore to what extent product descriptions and specifications contained in this publication are still applicable before or when you place an order.

We also **reserve the right to discontinue production and delivery of products**. Consequently, we cannot guarantee that all products named in this publication will always be available. The aforementioned does not apply in the case of individual agreements deviating from the foregoing for customer-specific products.
6. Unless otherwise agreed in individual contracts, **all orders are subject to our General Terms and Conditions of Supply**.
7. **Our manufacturing sites serving the automotive business apply the IATF 16949 standard**. The IATF certifications confirm our compliance with requirements regarding the quality management system in the automotive industry. Referring to customer requirements and customer specific requirements ("CSR") TDK always has and will continue to have the policy of respecting individual agreements. Even if IATF 16949 may appear to support the acceptance of unilateral requirements, we hereby like to emphasize that **only requirements mutually agreed upon can and will be implemented in our Quality Management System**. For clarification purposes we like to point out that obligations from IATF 16949 shall only become legally binding if individually agreed upon.

Important notes

8. The trade names EPCOS, CeraCharge, CeraDiode, CeraLink, CeraPad, CeraPlas, CSMP, CTVS, DeltaCap, DigiSiMic, ExoCore, FilterCap, FormFit, LeaXield, MiniBlue, MiniCell, MKD, MKK, MotorCap, PCC, PhaseCap, PhaseCube, PhaseMod, PhiCap, PowerHap, PQSine, PQvar, SIFERRIT, SIFI, SIKOREL, SilverCap, SIMDAD, SiMic, SIMID, SineFormer, SIOV, ThermoFuse, WindCap are **trademarks registered or pending** in Europe and in other countries. Further information will be found on the Internet at www.tdk-electronics.tdk.com/trademarks.

Release 2018-10