

RL78/I1A

R01DS0171EJ0320

RENESAS MCU

Rev.3.20

Sep 29, 2017

True Low Power Platform, High Resolution PWM and Rich Analog, 2.7 V to 5.5 V operation, 32 to 64 Kbyte Flash, for Inverter Control, Digital Power Control and Lighting Control Applications

1. OUTLINE

1.1 Features

Ultra-Low Power Technology

- 2.7 V to 5.5 V operation from a single supply
- Stop (RAM retained): 0.23 μ A, (LVD enabled): 0.31 μ A
- Halt (RTC + LVD): 0.60 μ A
- Operating: 156.25 μ A/MHz

16-bit RL78 CPU Core

- Delivers 41 DMIPS at maximum operating frequency of 32 MHz
- <R> • Instruction execution: 86% of instructions can be executed in 1 to 2 clock cycles
- CISC architecture (Harvard) with 3-stage pipeline
- <R> • Multiply signed & unsigned: 16 x 16 to 32-bit result in 1 clock cycle
- MAC: 16 x 16 to 32-bit result in 2 clock cycles
- 16-bit barrel shifter for shift & rotate in 1 clock cycle
- 1-wire on-chip debug function

Main Flash Memory

- Density: 32 KB to 64 KB
- Block size: 1 KB
- On-chip single voltage flash memory with protection from block erase/writing
- Self-programming with secure boot swap function and flash shield window function

Data Flash Memory

- Data flash with background operation
- Data flash size: 4 KB
- Erase cycles: 1 million (typ.)
- Erase/programming voltage: 2.7 V to 5.5 V

RAM

- 2 KB to 4 KB size options
- Supports operands or instructions
- Back-up retention in all modes

High-speed On-chip Oscillator

- 32 MHz with +/- 1% accuracy over voltage (2.7 V to 5.5 V) and temperature (-20°C to 85°C)
- Pre-configured settings: 32 MHz, 24 MHz, 16 MHz, 12 MHz, 8 MHz, 6 MHz, 4 MHz, 3 MHz, 2 MHz & 1 MHz

Reset and Supply Management

- Power-on reset (POR) monitor/generator
- Low voltage detection (LVD) with 6 setting options (Interrupt and/or reset function)

Data Memory Access (DMA) Controller

- Up to 2 fully programmable channels
- Transfer unit: 8- or 16-bit

16-bit timers KB0 to KB2, and KC0 for PWM output

16-bit timers KB0 to KB2: maximum 6 outputs (3 channels x 2)

- Smooth start function, dithering function, forced output stop function (unsynchronized with comparator or external interrupt) enables over-voltage protection, over-current protection and peak current control, and single/interleave PFC function
- Average resolution < 0.98 nsec output, 64 MHz (when using PLL) + dithering option

16-bit timer KC0 (1 channel x 6 (output))

- PWM output gating function by interlocking with 16-bit timers KB0, KB1, and KB2

Extended-Function Timers

- Multi-function 16-bit timers: Up to 8 channels
- Real-time clock (RTC): 1 channel (full calendar and alarm function with watch correction function)
- Interval timer: 12-bit, 1 channel
- 15 kHz watchdog timer: 1 channel (window function)

Multiple Communication Interfaces

- Up to 1 channel x I²C multi-master (SMBus/PMBus support)
- Up to 1 channel x CSI/SPI (7-, 8-bit)
- Up to 3 channels x UART (7-, 8-, 9-bit), DALI support 1 channel (8-, 16-, 17-, 24-bit, master and slave)
- Up to 1 channel x LIN

Rich Analog

- ADC: Up to 11 channels, 8/10-bit resolution, 2.125 μ s conversion time
- Supports 2.7 V
- Internal voltage reference (1.45 V)
- Comparator: High response time 70 ns (typ.), up to 6 channels, internal DAC 3 channels 8-bit resolution, window comparator mode
- PGA (x4 to x32): 6 input channels
- On-chip temperature sensor

Safety Features (IEC or UL 60730 compliance)

- Flash memory CRC calculation
- RAM parity error check
- RAM/SFR write protection
- Illegal memory access detection
- Clock stop/frequency detection
- ADC self-test

General Purpose I/O

- 5-V tolerant, high-current (up to 8.5 mA per pin)
- Open-drain, internal pull-up support

Operating Ambient Temperature

- Standard: -40°C to +105°C
- Extend: -40°C to +125°C

Package Type and Pin Count

SSOP: 20, 30, 38

- ROM, RAM capacities

Flash ROM	Data flash	RAM	RL78/I1A		
			20 pins	30 pins	38 pins
64 KB	4 KB	4 KB Note	–	R5F107AE	R5F107DE
32 KB	4 KB	2 KB	R5F1076C	R5F107AC	–

Note This is about 3 KB when the self-programming function and data flash function are used.

1.2 List of Part Numbers

Figure 1-1. Part Number, Memory Size, and Package of RL78/I1A

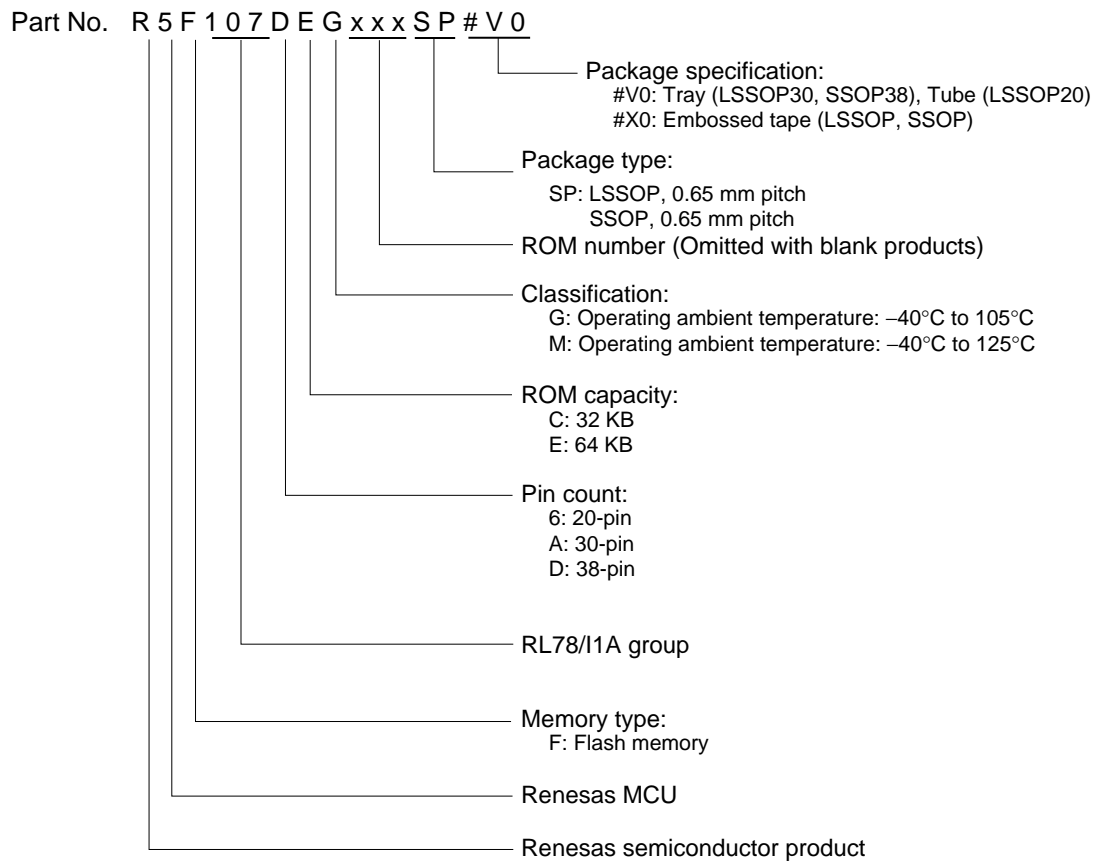

Pin count	Package	Operating Ambient Temperature	Part Number
20 pins	20-pin plastic LSSOP (4.4 × 6.5)	TA = -40 to +105°C	R5F1076CGSP#V0, R5F1076CGSP#X0
		TA = -40 to +125°C	R5F1076CMSP#V0, R5F1076CMSP#X0
30 pins	30-pin plastic LSSOP (7.62 mm (300))	TA = -40 to +105°C	R5F107ACGSP#V0, R5F107AEGSP#V0, R5F107ACGSP#X0, R5F107AEGSP#X0
		TA = -40 to +125°C	R5F107ACMSP#V0, R5F107AEMSP#V0, R5F107ACMSP#X0, R5F107AEMSP#X0
38 pins	38-pin plastic SSOP (7.62 mm (300))	TA = -40 to +105°C	R5F107DEGSP#V0, R5F107DEGSP#X0
		TA = -40 to +125°C	R5F107DEMSP#V0, R5F107DEMSP#X0

Caution The ordering part numbers represent the numbers at the time of publication. For the latest ordering part numbers, refer to the target product page of the Renesas Electronics website.

1.3 Pin Configuration (Top View)

1.3.1 20-pin products

- 20-pin plastic LSSOP (4.4 x 6.5)

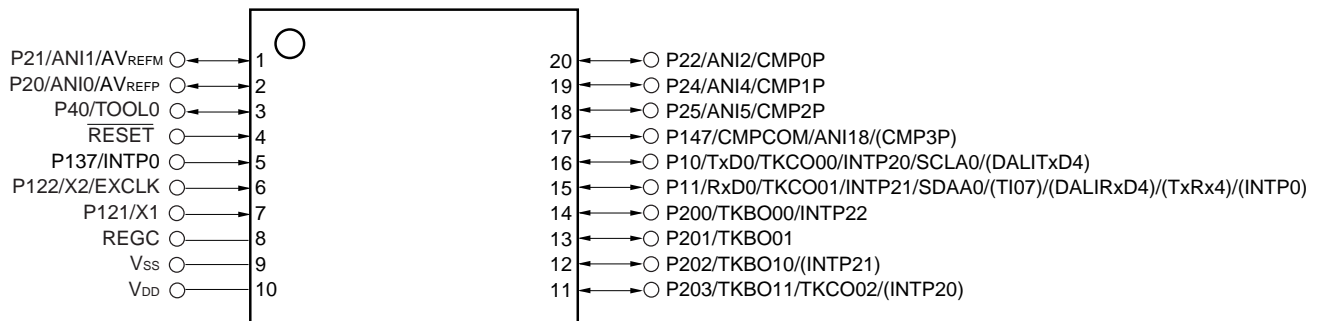

Caution Connect the REGC pin to Vss via a capacitor (0.47 to 1 μ F).

- Remarks**
1. For pin identification, see **1.4 Pin Identification**.
 2. Functions in parentheses in the above figure can be assigned via settings in the peripheral I/O redirection register (PIOR1) or the input switch control register (ISC). See **Figure 4-8 Format of Peripheral I/O Redirection Register (PIOR1)** and **Figure 15-20 Format of Input Switch Control Register (ISC) in the RL78/I1A User's Manual**.
 3. The shared function CMP3P can be assigned to P147 by setting the CMPSEL0 bit in the comparator input switch control register (CMPSEL).

1.3.2 30-pin products

- 30-pin plastic LSSOP (7.62 mm (300))

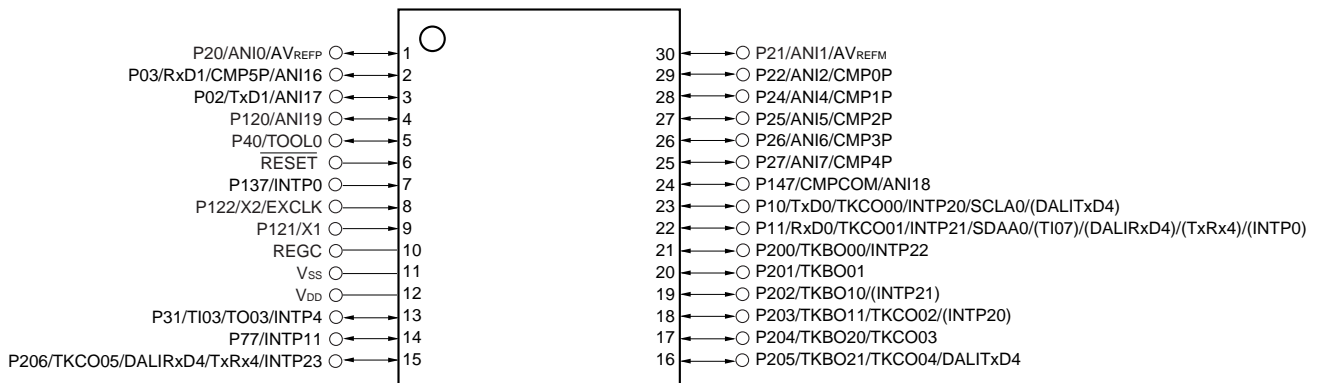

Caution Connect the REGC pin to V_{SS} via a capacitor (0.47 to 1 μ F).

- Remarks**
- For pin identification, see 1.4 Pin Identification.
 - Functions in parentheses in the above figure can be assigned via settings in the peripheral I/O redirection register (PIOR1) or the input switch control register (ISC). See **Figure 4-8 Format of Peripheral I/O Redirection Register (PIOR1)** and **Figure 15-20 Format of Input Switch Control Register (ISC)** in the RL78/I1A User's Manual.

1.3.3 38-pin products

- 38-pin plastic SSOP (7.62 mm (300))

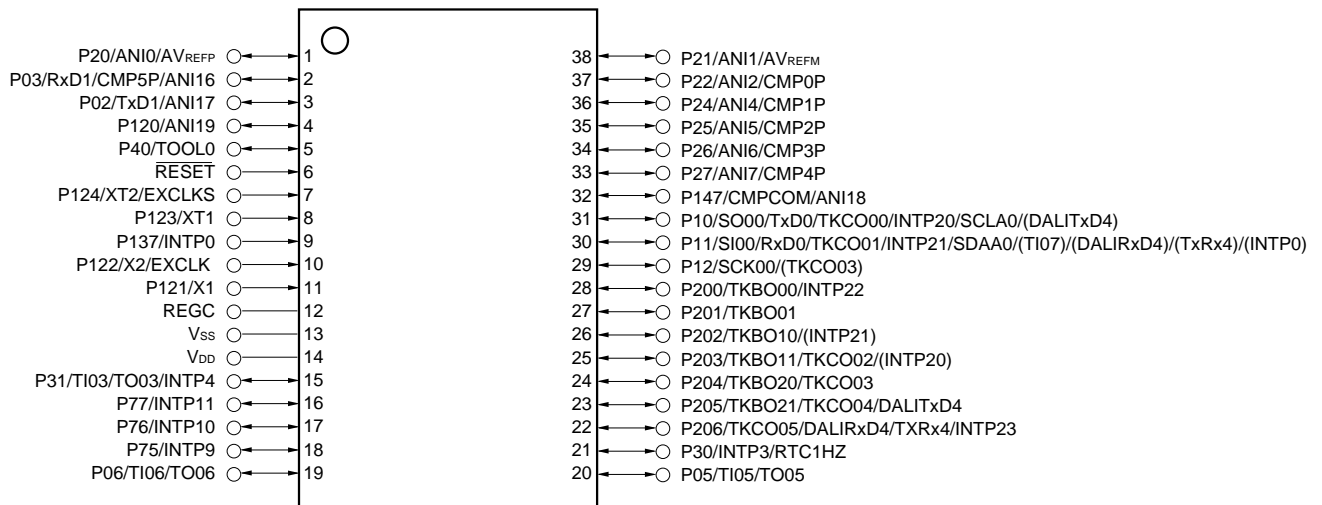

Caution Connect the REGC pin to V_{SS} via a capacitor (0.47 to 1 μ F).

Remarks 1. For pin identification, see 1.4 Pin Identification.

2. Functions in parentheses in the above figure can be assigned via settings in the peripheral I/O redirection register (PIOR1) or the input switch control register (ISC). See **Figure 4-8 Format of Peripheral I/O Redirection Register (PIOR1)** and **Figure 15-20 Format of Input Switch Control Register (ISC)** in the RL78/I1A User's Manual.

1.4 Pin Identification

ANI0 to ANI2, ANI4 to ANI7, ANI16 to ANI19:	Analog Input	REGC:	Regulator Capacitance
AVREFM:	Analog Reference Voltage Minus	RESET:	Reset
AVREFP:	Analog Reference Voltage Plus	RTC1HZ:	Real-time Clock Correction Clock (1 Hz) Output
CMP0P to CMP5P:	Comparator Analog Input	RxD0, RxD1, DALIRxD4:	Receive Data
CMPCOM:	Comparator External Reference Voltage	SCK00:	Serial Clock Input/Output
EXCLK:	External Clock Input (Main System Clock)	SCLA0:	Serial Clock Input/Output
EXCLKS:	External Clock Input (Subsystem Clock)	SDAA0:	Serial Data Input/Output
INTP0, INTP3, INTP4, INTP9, INTP10, INTP11, INTP20 to INTP23:	Interrupt Request from Peripheral	SI00:	Serial Data Input
P02, P03, P05, P06:	Port 0	SO00:	Serial Data Output
P10 to P12:	Port 1	TI03, TI05, TI06, TI07:	Timer Input
P20 to P22, P24 to P27:	Port 2	TO03, TO05, TO06, TKBO00, TKBO01 to TKBO20, TKBO21,	Timer Output
P30, P31:	Port 3	TKCO00 to TKCO05:	Timer Output
P40:	Port 4	TOOL0:	Data Input/Output for Tool
P75 to P77:	Port 7	TxRx4:	Serial Data Input/Output for Single Wired UART
P120 to P124:	Port 12	TxD0, TxD1	
P137:	Port 13	DALITxD4:	Transmit Data
P147:	Port 14	V _{DD} :	Power Supply
P200 to P206:	Port 20	V _{SS} :	Ground
		X1, X2:	Crystal Oscillator (Main System Clock)
		XT1, XT2:	Crystal Oscillator (Subsystem Clock)

1.5 Block Diagram

1.5.1 20-pin products

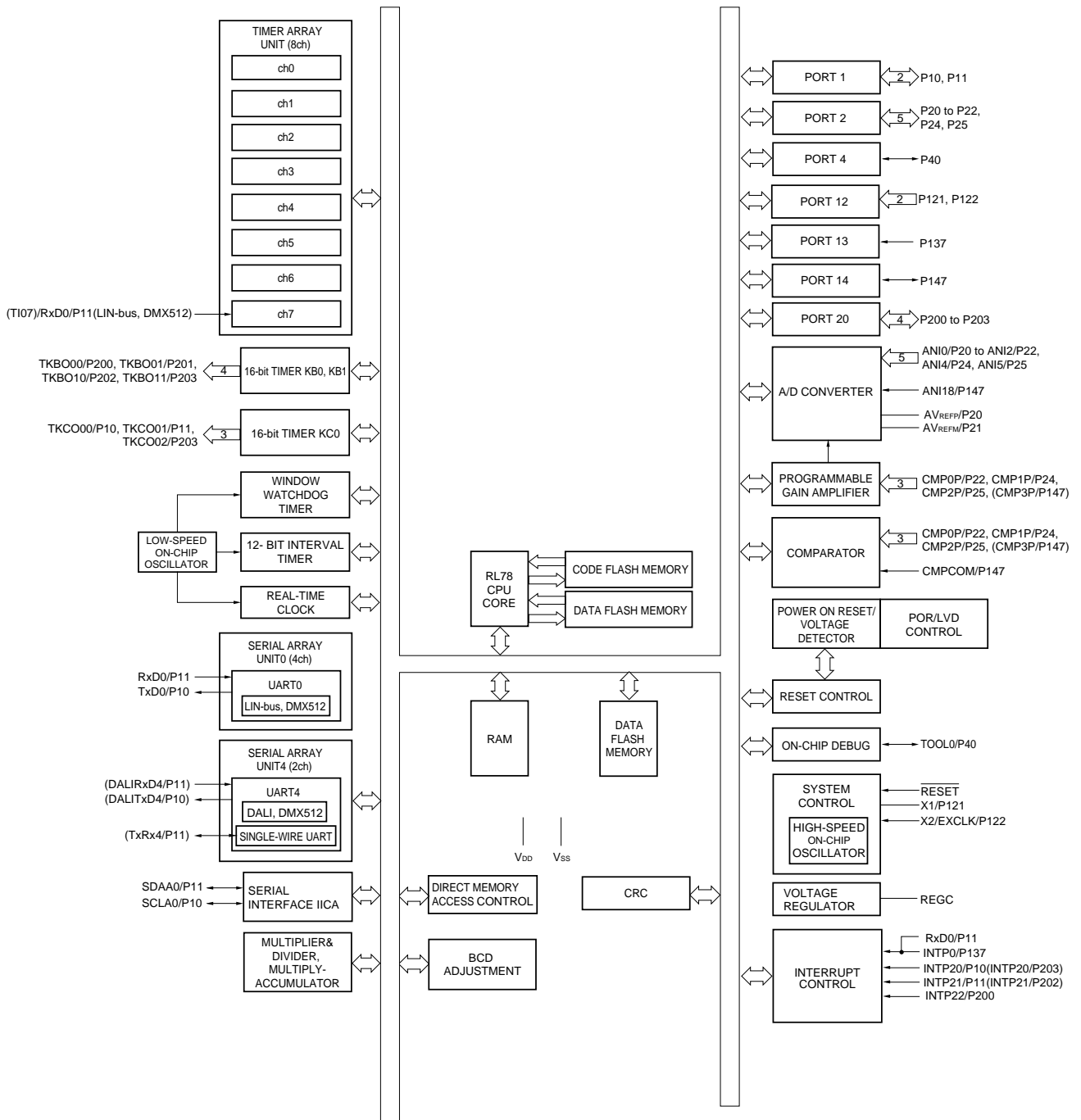

- Remarks 1.** Functions in parentheses in the above figure can be assigned via settings in the peripheral I/O redirection register (PIOR1) or the input switch control register (ISC). See **Figure 4-8 Format of Peripheral I/O Redirection Register (PIOR1)** and **Figure 15-20 Format of Input Switch Control Register (ISC)** in the RL78/I1A User's Manual.
- 2.** The shared function CMP3P can be assigned to P147 by setting the CMPSEL0 bit in the comparator input switch control register (CMPSEL).

1.5.2 30-pin products

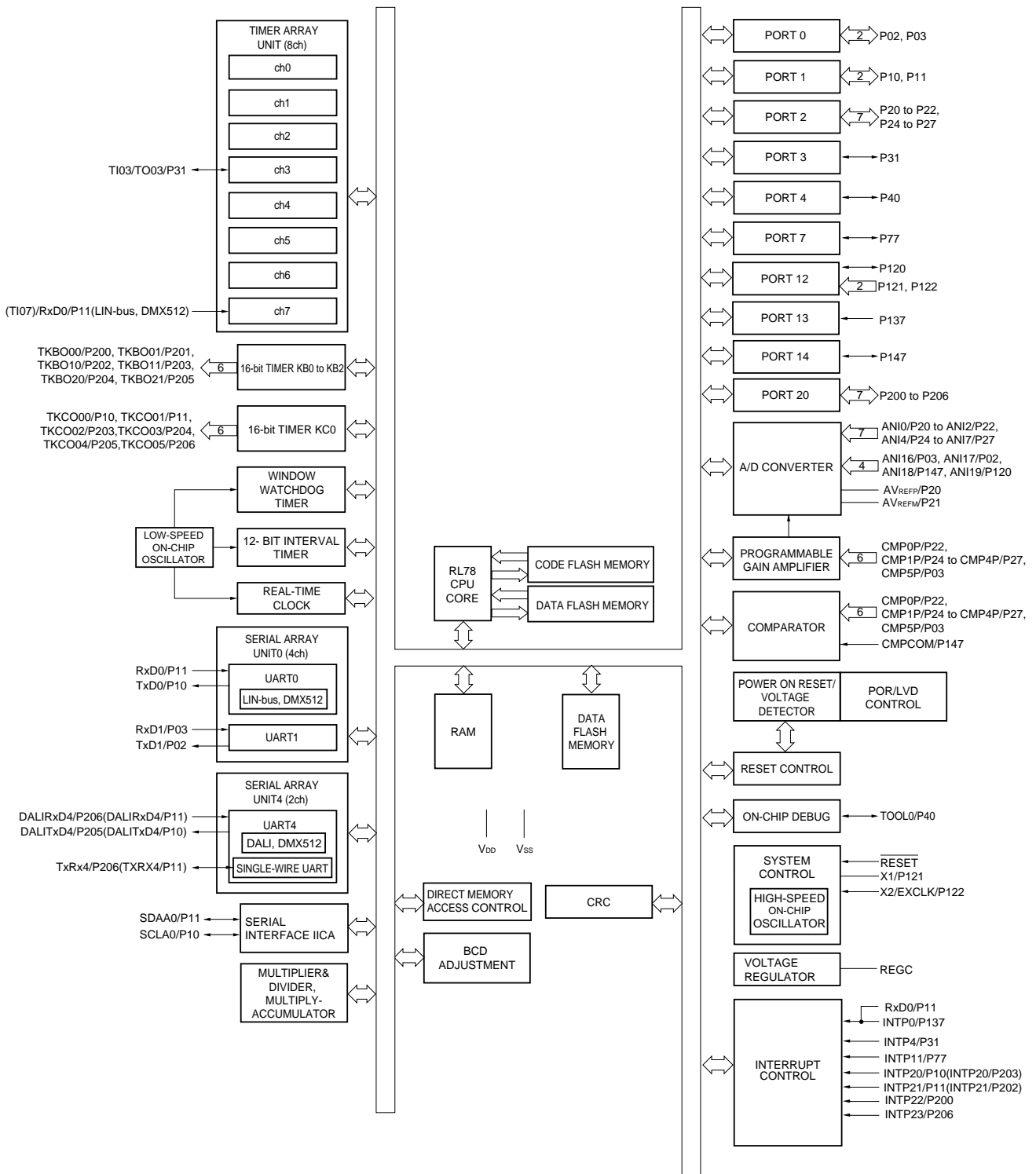

Remark Functions in parentheses in the above figure can be assigned via settings in the peripheral I/O redirection register (PIOR1) or the input switch control register (ISC). See **Figure 4-8 Format of Peripheral I/O Redirection Register (PIOR1)** and **Figure 15-20 Format of Input Switch Control Register (ISC)** in the RL78/I1A User's Manual.

1.5.3 38-pin products

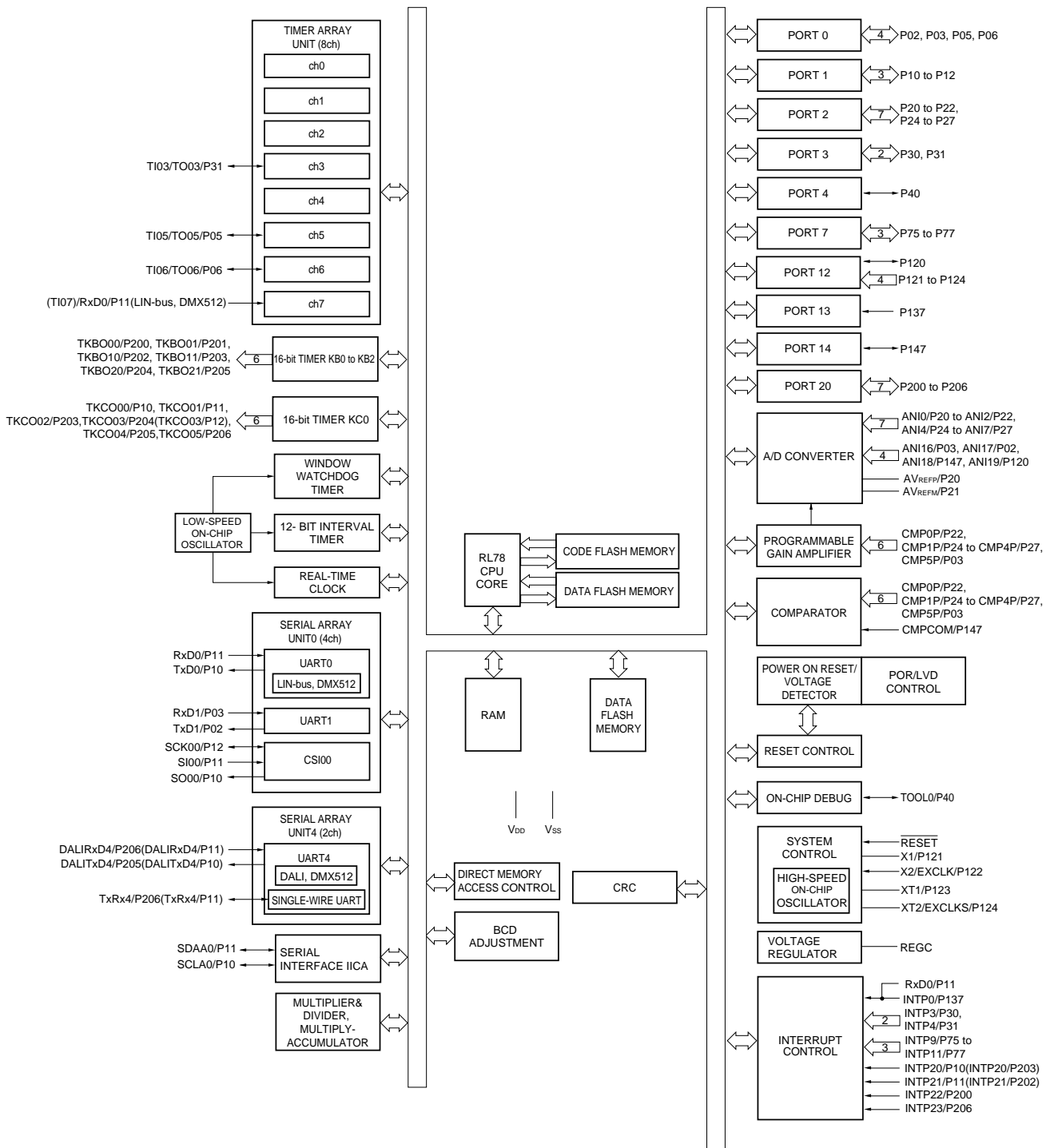

Remark Functions in parentheses in the above figure can be assigned via settings in the peripheral I/O redirection register (PIOR1) or the input switch control register (ISC). See **Figure 4-8 Format of Peripheral I/O Redirection Register (PIOR1)** and **Figure 15-20 Format of Input Switch Control Register (ISC)** in the RL78/I1A User's Manual.

1.6 Outline of Functions

Caution This outline describes the functions at the time when Peripheral I/O redirection register (PIOR1) is set to 00H.

(1/3)

Item		20-pin	30-pin		38-pin
		R5F1076C	R5F107AC	R5F107AE	R5F107DE
Code flash memory (KB)		32	32	64	64
Data flash memory (KB)		4	4	4	4
RAM (KB)		2	2	4 ^{Note 1}	4 ^{Note 1}
Address space		1 MB			
Main system clock	High-speed system clock	X1 (crystal/ceramic) oscillation, external main system clock input (EXCLK) HS (High-speed main) mode: 1 to 20 MHz ($V_{DD} = 2.7$ to 5.5 V), LS (Low-speed main) mode: 1 to 8 MHz ($V_{DD} = 2.7$ to 5.5 V)			
	High-speed on-chip oscillator	HS (High-speed main) mode: 1 to 32 MHz ($V_{DD} = 2.7$ to 5.5 V), LS (Low-speed main) mode: 1 to 8 MHz ($V_{DD} = 2.7$ to 5.5 V)			
Clock for 16-bit timers KB0 to KB2, and KC0		64 MHz (TYP.)			
Subsystem clock (38-pin products only)		XT1 (crystal) oscillation, external subsystem clock input (EXCLKS) 32.768 kHz			
Low-speed on-chip oscillator		15 kHz (TYP.)			
General-purpose register		(8-bit register × 8) × 4 banks			
Minimum instruction execution time		0.03125 μ s (High-speed on-chip oscillator: $f_{IH} = 32$ MHz operation)			
		0.05 μ s (High-speed system clock: $f_{MX} = 20$ MHz operation)			
		30.5 μ s (Subsystem clock: $f_{SUB} = 32.768$ kHz operation) (38-pin products only)			
Instruction set		<ul style="list-style-type: none"> • 8-bit operation, 16-bit operation • Multiplication (8 bits × 8 bits) • Bit manipulation (Set, reset, test, and Boolean operation), etc. 			
I/O port	Total	16	26	34	
	CMOS I/O	13	23	29	
	CMOS input	3	3	5	
	CMOS output	–	–	–	
Timer	16-bit timer TAU	8 channels (no timer output)	8 channels (timer output: 1, PWM output: 1 ^{Note 2})	8 channels (timer outputs: 3, PWM outputs: 3 ^{Note 2})	
	16-bit timer KB	2 channels (PWM outputs: 4)	3 channels (PWM outputs: 6)		
	16-bit timer KC	1 channel (PWM outputs: 3)	1 channel (PWM outputs: 6)		

Notes 1. This is about 3 KB when the self-programming function and data flash function are used. (For details, see **CHAPTER 3 in the RL78/I1A User's Manual.**)

2. The number of PWM outputs varies depending on the setting of channels in use (the number of masters and slaves) (see **6.9.3 Operation as multiple PWM output function in the RL78/I1A User's Manual.**)

(2/3)

Item		20-pin	30-pin	38-pin
		R5F1076C	R5F107AC, R5F107AE	R5F107DE
Timer	Watchdog timer	1 channel		
	Real-time clock (RTC)	1 channel ^{Notes 1, 2}		
	12-bit interval timer (IT)	1 channel		
	RTC output	-		1 1 Hz (subsystem clock: $f_{SUB} = 32.768$ kHz)
8/10-bit resolution A/D converter		6 channels	11 channels	11 channels
Comparator		4 channels	6 channels	6 channels
Programmable gain amplifier		1 channel		
	Input ^{Note 3}	4 channels	6 channels	6 channels
Serial interface		<p>[20-pin] ^{Note 5}</p> <ul style="list-style-type: none"> • UART (Supporting LIN-bus and DMX512): 1 channel • UART (Supporting DALI communication): 1 channel <p>[30-pin products]</p> <ul style="list-style-type: none"> • UART (Supporting LIN-bus and DMX512): 1 channel • UART: 1 channel • UART (Supporting DALI communication): 1 channel <p>[38-pin products]</p> <ul style="list-style-type: none"> • CSI: 1 channel/UART (Supporting LIN-bus and DMX512): 1 channel • UART: 1 channel • UART (Supporting DALI communication): 1 channel 		
	I ² C bus	1 channel	1 channel	1 channel
Multiplier and divider/multiply-accumulator		<ul style="list-style-type: none"> • 16 bits × 16 bits = 32 bits (Unsigned or signed) • 32 bits ÷ 32 bits = 32 bits (Unsigned) • 16 bits × 16 bits + 32 bits = 32 bits (Unsigned or signed) 		
DMA controller		2 channels		
Vectored interrupt sources	Internal	27	30	30
	External	7	10	11
Reset		<ul style="list-style-type: none"> • Reset by \overline{RESET} pin • Internal reset by watchdog timer • Internal reset by power-on-reset • Internal reset by voltage detector • Internal reset by illegal instruction execution^{Note 4} • Internal reset by RAM parity error • Internal reset by illegal-memory access 		

- Notes**
1. The subsystem clock (f_{SUB}) can be selected as the operating clock only for 38-pin products.
 2. The 20- and 30-pin products can only be used as the constant-period interrupt function.
 3. The comparator input is alternatively used with analog input pin (ANI pin).
 4. The illegal instruction is generated when instruction code FFH is executed.
Reset by the illegal instruction execution not issued by emulation with the in-circuit emulator or on-chip debug emulator.
 5. The 20 pin products can only be used 1 UART simultaneously due to sharing of the same I/O pins.

(3/3)

Item	20-pin	30-pin	38-pin
	R5F1076C	R5F107AC, R5F107AE	R5F107DE
Power-on-reset circuit	<ul style="list-style-type: none"> • Power-on-reset: 1.51 V (TYP.) • Power-down-reset: 1.50 V (TYP.) 		
Voltage detector	<ul style="list-style-type: none"> • Rising edge: 2.81 V to 4.06 V (6 stages) • Falling edge: 2.75 V to 3.98 V (6 stages) 		
On-chip debug function	Provided		
Power supply voltage	$V_{DD} = 2.7$ to 5.5 V		
Operating ambient temperature	$T_A = -40$ to $+105^\circ\text{C}$ (G: Industrial applications), $T_A = -40$ to $+125^\circ\text{C}$ (M: Industrial applications)		

2. ELECTRICAL SPECIFICATIONS

(G: Industrial applications, $T_A = -40$ to $+105^\circ\text{C}$)

In this chapter, shows the electrical specifications of the target products.

Target products (G: Industrial applications): $T_A = -40$ to $+105^\circ\text{C}$
R5F107xxGxx

Cautions 1. The RL78/I1A has an on-chip debug function, which is provided for development and evaluation.

Do not use the on-chip debug function in products designated for mass production, because the guaranteed number of rewritable times of the flash memory may be exceeded when this function is used, and product reliability therefore cannot be guaranteed. Renesas Electronics is not liable for problems occurring when the on-chip debug function is used.

2. The pins mounted depend on the product. See 2.1 Port Function to 2.2.1 Functions for each product in the RL78/I1A User's Manual.

2.1 Absolute Maximum Ratings

Absolute Maximum Ratings ($T_A = 25^\circ\text{C}$) (1/2)

Parameter	Symbols	Conditions	Ratings	Unit
Supply voltage	V_{DD}		-0.5 to +6.5	V
REGC pin input voltage	V_{IREGC}	REGC	-0.3 to +2.8 and -0.3 to $V_{DD} + 0.3$ ^{Note 1}	V
Input voltage	V_{I1}	P02, P03, P05, P06, P10 to P12, P20 to P22, P24 to P27, P30, P31, P40, P75 to P77, P120 to P124, P137, P147, P200 to P206, EXCLK, EXCLKS, RESET	-0.3 to $V_{DD} + 0.3$ ^{Note 2}	V
Output voltage	V_{O1}	P02, P03, P05, P06, P10 to P12, P20 to P22, P24 to P27, P30, P31, P40, P75 to P77, P120, P147, P200 to P206	-0.3 to $V_{DD} + 0.3$ ^{Note 2}	V
Analog input voltage	V_{AI1}	ANI0 to ANI2, ANI4 to ANI7, ANI16 to ANI19	-0.3 to $V_{DD} + 0.3$ and -0.3 to $AV_{REF(+)}$ $+ 0.3$ ^{Notes 2, 3}	V

- Notes**
1. Connect the REGC pin to V_{SS} via a capacitor (0.47 to 1 μF). This value regulates the absolute maximum rating of the REGC pin. Do not use this pin with voltage applied to it.
 2. Must be 6.5 V or lower.
 3. Do not exceed $AV_{REF(+)} + 0.3$ V in case of A/D conversion target pin.

Caution Product quality may suffer if the absolute maximum rating is exceeded even momentarily for any parameter. That is, the absolute maximum ratings are rated values at which the product is on the verge of suffering physical damage, and therefore the product must be used under conditions that ensure that the absolute maximum ratings are not exceeded.

- Remarks**
1. Unless specified otherwise, the characteristics of alternate-function pins are the same as those of the port pins.
 2. $AV_{REF(+)}$: + side reference voltage of the A/D converter.
 3. V_{SS} : Reference voltage

Absolute Maximum Ratings ($T_A = 25^\circ\text{C}$) (2/2)

Parameter	Symbols	Conditions		Ratings	Unit
Output current, high	I_{OH1}	Per pin	P02, P03, P05, P06, P10 to P12, P30, P31, P40, P75 to P77, P120, P147, P200 to P206	-40	mA
		Total of all pins -170 mA	P02, P03, P40, P120	-70	mA
			P05, P06, P10 to P12, P30, P31, P75 to P77, P147, P200 to P206	-100	mA
	I_{OH2}	Per pin	P20 to P22, P24 to P27	-0.5	mA
		Total of all pins		-2	mA
	Output current, low	I_{OL1}	Per pin	P02, P03, P05, P06, P10 to P12, P30, P31, P40, P75 to P77, P120, P147, P200 to P206	40
Total of all pins 170 mA			P02, P03, P40, P120	70	mA
			P05, P06, P10 to P12, P30, P31, P75 to P77, P147, P200 to P206	100	mA
I_{OL2}		Per pin	P20 to P22, P24 to P27	1	mA
		Total of all pins		5	mA
Operating ambient temperature		T_A	In normal operation mode		-40 to +105
	In flash memory programming mode				
Storage temperature	T_{stg}			-65 to +150	$^\circ\text{C}$

Caution Product quality may suffer if the absolute maximum rating is exceeded even momentarily for any parameter. That is, the absolute maximum ratings are rated values at which the product is on the verge of suffering physical damage, and therefore the product must be used under conditions that ensure that the absolute maximum ratings are not exceeded.

Remark Unless specified otherwise, the characteristics of alternate-function pins are the same as those of the port pins.

2.2 Oscillator Characteristics

2.2.1 X1, XT1 oscillator characteristics

($T_A = -40$ to $+105^\circ\text{C}$, $2.7\text{ V} \leq V_{DD} \leq 5.5\text{ V}$, $V_{SS} = 0\text{ V}$)

Parameter	Resonator	Conditions	MIN.	TYP.	MAX.	Unit
X1 clock oscillation frequency (f_X) ^{Note}	Ceramic resonator/crystal resonator		1.0		20.0	MHz
XT1 clock oscillation frequency (f_{XT}) ^{Note}	Crystal resonator		32	32.768	35	kHz

Note Indicates only permissible oscillator frequency ranges. See **AC Characteristics** for instruction execution time. Request evaluation by the manufacturer of the oscillator circuit mounted on a board to check the oscillator characteristics.

Caution Since the CPU is started by the high-speed on-chip oscillator clock after a reset release, check the X1 clock oscillation stabilization time using the oscillation stabilization time counter status register (OSTC) by the user. Determine the oscillation stabilization time of the OSTC register and the oscillation stabilization time select register (OSTS) after sufficiently evaluating the oscillation stabilization time with the resonator to be used.

Remark When using the X1 oscillator and XT1 oscillator, see **5.4 System Clock Oscillator** in the **RL78/I1A User's Manual**.

2.2.2 On-chip oscillator characteristics

($T_A = -40$ to $+105^\circ\text{C}$, $2.7\text{ V} \leq V_{DD} \leq 5.5\text{ V}$, $V_{SS} = 0\text{ V}$)

Oscillators	Parameters	Conditions	MIN.	TYP.	MAX.	Unit
High-speed on-chip oscillator clock frequency ^{Note 1}	f_{IH}		1		32	MHz
High-speed on-chip oscillator clock frequency accuracy ^{Note 2}		$T_A = -20$ to 85°C	-1		+1	%
		$T_A = -40$ to 105°C	-1.5		+1.5	%
Low-speed on-chip oscillator clock frequency	f_{IL}			15		kHz
Low-speed on-chip oscillator clock frequency accuracy			-15		+15	%

Notes 1. Frequency can be selected in a high-speed on-chip oscillator. Selected by bits 0 to 3 of option byte (000C2H/010C2H).

2. This indicates the oscillator characteristics only. See **AC Characteristics** for instruction execution time.

2.2.3 PLL characteristics

($T_A = -40$ to $+105^\circ\text{C}$, $2.7\text{ V} \leq V_{DD} \leq 5.5\text{ V}$, $V_{SS} = 0\text{ V}$)

Parameter	Symbol	Conditions	MIN.	TYP.	MAX.	Unit
PLL input clock frequency ^{Note}	f_{PLLIN}	High-speed system clock is selected ($f_{MX} = 4\text{ MHz}$)	3.94	4.00	4.06	MHz
		High-speed on-chip oscillator clock is selected ($f_{IH} = 4\text{ MHz}$)	3.94	4.00	4.06	MHz
PLL output clock frequency ^{Note}	f_{PLL}		$f_{PLLIN} \times 16$			MHz

Note This only indicates the oscillator characteristics. See **AC Characteristics** for instruction execution time.

2.3 DC Characteristics

2.3.1 Pin characteristics

($T_A = -40$ to $+105^\circ\text{C}$, $2.7\text{ V} \leq V_{DD} \leq 5.5\text{ V}$, $V_{SS} = 0\text{ V}$)

Items	Symbol	Conditions	MIN.	TYP.	MAX.	Unit	
Output current, high ^{Note 1}	I _{OH1}	Per pin for P02, P03, P05, P06, P10 to P12, P30, P31, P40, P75 to P77, P120, P147, P200 to P206	4.0 V ≤ V _{DD} ≤ 5.5 V			-3.0 ^{Note 2}	mA
			2.7 V ≤ V _{DD} < 4.0 V			-1.0	mA
		Total of P02, P03, P40, P120 (When duty ≤ 70% ^{Note 3})	4.0 V ≤ V _{DD} ≤ 5.5 V			-12.0	mA
			2.7 V ≤ V _{DD} < 4.0 V			-4.0	mA
		Total of P05, P06, P10 to P12, P30, P31, P75 to P77, P147, P200 to P206 (When duty ≤ 70% ^{Note 3})	4.0 V ≤ V _{DD} ≤ 5.5 V			-30.0	mA
			2.7 V ≤ V _{DD} < 4.0 V			-10.0	mA
	Total of all pins (When duty ≤ 70% ^{Note 3})	4.0 V ≤ V _{DD} ≤ 5.5 V			-30.0	mA	
		2.7 V ≤ V _{DD} < 4.0 V			-14.0	mA	
	I _{OH2}	Per pin for P20 to P22, P24 to P27	2.7 V ≤ V _{DD} ≤ 5.5 V			-0.1 ^{Note 2}	mA
			2.7 V ≤ V _{DD} ≤ 5.5 V			-0.7	mA

- Notes**
- Value of current at which the device operation is guaranteed even if the current flows from the V_{DD} pin to an output pin.
 - However, do not exceed the total current value.
 - Specification under conditions where the duty factor ≤ 70%.
The output current value that has changed to the duty factor > 70% the duty ratio can be calculated with the following expression (when changing the duty factor from 70% to n%).
 - Total output current of pins = (I_{OH} × 0.7)/(n × 0.01)
 <Example> Where n = 80% and I_{OH} = -10.0 mA
 Total output current of pins = (-10.0 × 0.7)/(80 × 0.01) ≅ -8.7 mA
 However, the current that is allowed to flow into one pin does not vary depending on the duty factor. A current higher than the absolute maximum rating must not flow into one pin.

Caution P02, P10 to P12 do not output high level in N-ch open-drain mode.

Remark Unless specified otherwise, the characteristics of alternate-function pins are the same as those of the port pins.

($T_A = -40$ to $+105^\circ\text{C}$, $2.7\text{ V} \leq V_{DD} \leq 5.5\text{ V}$, $V_{SS} = 0\text{ V}$)

Items	Symbol	Conditions	MIN.	TYP.	MAX.	Unit
Output current, I_{OL} ^{Note 1}	I _{OL1}	Per pin for P02, P03, P05, P06, P10 to P12, P30, P31, P40, P75 to P77, P120, P147, P200 to P206	$4.0\text{ V} \leq V_{DD} \leq 5.5\text{ V}$		8.5 ^{Note 2}	mA
			$2.7\text{ V} \leq V_{DD} < 4.0\text{ V}$		1.5 ^{Note 2}	mA
		Total of P02, P03, P40, P120 (When duty $\leq 70\%$ ^{Note 3})	$4.0\text{ V} \leq V_{DD} \leq 5.5\text{ V}$		40.0	mA
			$2.7\text{ V} \leq V_{DD} < 4.0\text{ V}$		7.5	mA
		Total of P05, P06, P10 to P12, P30, P31, P75 to P77, P147, P200 to P206 (When duty $\leq 70\%$ ^{Note 3})	$4.0\text{ V} \leq V_{DD} \leq 5.5\text{ V}$		40.0	mA
			$2.7\text{ V} \leq V_{DD} < 4.0\text{ V}$		17.5	mA
	Total of all pins (When duty $\leq 70\%$ ^{Note 3})	$4.0\text{ V} \leq V_{DD} \leq 5.5\text{ V}$		80.0	mA	
		$2.7\text{ V} \leq V_{DD} < 4.0\text{ V}$		25.0	mA	
	I _{OL2}	Per pin for P20 to P22, P24 to P27	$2.7\text{ V} \leq V_{DD} \leq 5.5\text{ V}$		0.4 ^{Note 2}	mA
			$2.7\text{ V} \leq V_{DD} \leq 5.5\text{ V}$		2.8	mA
		Total of all pins (When duty $\leq 70\%$ ^{Note 3})				

Notes 1. Value of current at which the device operation is guaranteed even if the current flows from an output pin to the V_{SS} pin.

2. However, do not exceed the total current value.

3. Specification under conditions where the duty factor $\leq 70\%$.

The output current value that has changed to the duty factor $> 70\%$ the duty ratio can be calculated with the following expression (when changing the duty factor from 70% to n%).

- Total output current of pins = $(I_{OL} \times 0.7)/(n \times 0.01)$

<Example> Where $n = 80\%$ and $I_{OL} = -10.0\text{ mA}$

$$\text{Total output current of pins} = (-10.0 \times 0.7)/(80 \times 0.01) \cong -8.7\text{ mA}$$

However, the current that is allowed to flow into one pin does not vary depending on the duty factor.

A current higher than the absolute maximum rating must not flow into one pin.

Remark Unless specified otherwise, the characteristics of alternate-function pins are the same as those of the port pins.

($T_A = -40$ to $+105^\circ\text{C}$, $2.7\text{ V} \leq V_{DD} \leq 5.5\text{ V}$, $V_{SS} = 0\text{ V}$)

Items	Symbol	Conditions	MIN.	TYP.	MAX.	Unit	
Input voltage, high	V_{IH1}	P02, P03, P05, P06, P10 to P12, P20 to P22, P24 to P27, P30, P31, P40, P75 to P77, P120 to P124, P137, P147, P200 to P206, EXCLK, EXCLKS, RESET	Normal input buffer	$0.8V_{DD}$		V_{DD}	V
	V_{IH2}	P03, P10, P11	TTL input buffer $4.0\text{ V} \leq V_{DD} \leq 5.5\text{ V}$	2.1		V_{DD}	V
			TTL input buffer $3.3\text{ V} \leq V_{DD} < 4.0\text{ V}$	2.0		V_{DD}	V
			TTL input buffer $2.7\text{ V} \leq V_{DD} < 3.3\text{ V}$	1.5		V_{DD}	V
Input voltage, low	V_{IL1}	P02, P03, P05, P06, P10 to P12, P20 to P22, P24 to P27, P30, P31, P40, P75 to P77, P120 to P124, P137, P147, P200 to P206, EXCLK, EXCLKS, RESET	Normal input buffer	0		$0.2V_{DD}$	V
	V_{IL2}	P03, P10, P11	TTL input buffer $4.0\text{ V} \leq V_{DD} \leq 5.5\text{ V}$	0		0.8	V
			TTL input buffer $3.3\text{ V} \leq V_{DD} < 4.0\text{ V}$	0		0.5	V
			TTL input buffer $2.7\text{ V} \leq V_{DD} < 3.3\text{ V}$	0		0.32	V

Caution The maximum value of V_{IH} of pins P02, P10 to P12 is V_{DD} , even in the N-ch open-drain mode.

Remark Unless specified otherwise, the characteristics of alternate-function pins are the same as those of the port pins.

($T_A = -40$ to $+105^\circ\text{C}$, $2.7\text{ V} \leq V_{DD} \leq 5.5\text{ V}$, $V_{SS} = 0\text{ V}$)

Items	Symbol	Conditions	MIN.	TYP.	MAX.	Unit
Output voltage, high	V _{OH1}	P02, P03, P05, P06, P10 to P12, P30, P31, P40, P75 to P77, P120, P147, P200 to P206	$4.0\text{ V} \leq V_{DD} \leq 5.5\text{ V}$, $I_{OH1} = -3.0\text{ mA}$			V
			$2.7\text{ V} \leq V_{DD} \leq 5.5\text{ V}$, $I_{OH1} = -1.0\text{ mA}$	$V_{DD} - 0.7$		V
	V _{OH2}	P20 to P22, P24 to P27	$2.7\text{ V} \leq V_{DD} \leq 5.5\text{ V}$, $I_{OH2} = -100\ \mu\text{A}$	$V_{DD} - 0.5$		V
Output voltage, low	V _{OL1}	P02, P03, P05, P06, P10 to P12, P30, P31, P40, P75 to P77, P120, P147, P200 to P206	$4.0\text{ V} \leq V_{DD} \leq 5.5\text{ V}$, $I_{OL1} = 8.5\text{ mA}$		0.7	V
			$4.0\text{ V} \leq V_{DD} \leq 5.5\text{ V}$, $I_{OL1} = 4.0\text{ mA}$		0.4	V
			$2.7\text{ V} \leq V_{DD} \leq 5.5\text{ V}$, $I_{OL1} = 1.5\text{ mA}$		0.4	V
	V _{OL2}	P20 to P22, P24 to P27	$2.7\text{ V} \leq V_{DD} \leq 5.5\text{ V}$, $I_{OL2} = 400\ \mu\text{A}$		0.4	V

Caution P02, P10 to P12 do not output high level in N-ch open-drain mode.

Remark Unless specified otherwise, the characteristics of alternate-function pins are the same as those of the port pins.

($T_A = -40$ to $+105^\circ\text{C}$, $2.7\text{ V} \leq V_{DD} \leq 5.5\text{ V}$, $V_{SS} = 0\text{ V}$)

Items	Symbol	Conditions	MIN.	TYP.	MAX.	Unit		
Input leakage current, high	I_{LH1}	P02, P03, P05, P06, P10 to P12, P20 to P22, P24 to P27, P30, P31, P40, P75 to P77, P120, P137, P147, P200 to P206, RESET	$V_i = V_{DD}$			1	μA	
	I_{LH2}	P121 to P124 (X1, X2, XT1, XT2, EXCLK, EXCLKS)	$V_i = V_{DD}$	In input port or external clock input			1	μA
				In resonator connection			10	μA
Input leakage current, low	I_{LIL1}	P02, P03, P05, P06, P10 to P12, P20 to P22, P24 to P27, P30, P31, P40, P75 to P77, P120, P137, P147, P200 to P206, RESET	$V_i = V_{SS}$			-1	μA	
	I_{LIL2}	P121 to P124 (X1, X2, XT1, XT2, EXCLK, EXCLKS)	$V_i = V_{SS}$	In input port or external clock input			-1	μA
				In resonator connection			-10	μA
On-chip pull-up resistance	R_U	P02, P03, P05, P06, P10 to P12, P30, P31, P40, P75 to P77, P120, P147, P200 to P206	$V_i = V_{SS}$, In input port	10	20	100	$\text{k}\Omega$	

Remark Unless specified otherwise, the characteristics of alternate-function pins are the same as those of the port pins.

2.3.2 Supply current characteristics

 $(T_A = -40$ to $+105^\circ\text{C}$, $2.7\text{ V} \leq V_{DD} \leq 5.5\text{ V}$, $V_{SS} = 0\text{ V}$) (1/2)

Parameter	Symbol	Conditions		MIN.	TYP.	MAX.	Unit		
Supply current Note 1	I _{DD1}	Operating mode	HS (high-speed main) mode ^{Note 5}	$f_{IH} = 32\text{ MHz}$ ^{Note 3}	$V_{DD} = 5.0\text{ V}$		5.0	7.5	mA
					$V_{DD} = 3.0\text{ V}$		5.0	7.5	mA
				$f_{IH} = 24\text{ MHz}$ ^{Note 3}	$V_{DD} = 5.0\text{ V}$		3.9	5.8	mA
					$V_{DD} = 3.0\text{ V}$		3.9	5.8	mA
				$f_{IH} = 16\text{ MHz}$ ^{Note 3}	$V_{DD} = 5.0\text{ V}$		2.9	4.2	mA
					$V_{DD} = 3.0\text{ V}$		2.9	4.2	mA
			LS (low-speed main) mode ^{Note 5}	$f_{IH} = 8\text{ MHz}$ ^{Note 3} , $T_A = -40$ to $+85^\circ\text{C}$	$V_{DD} = 3.0\text{ V}$		1.3	2.0	mA
			HS (high-speed main) mode ^{Note 5}	$f_{MX} = 20\text{ MHz}$ ^{Note 2} , $V_{DD} = 5.0\text{ V}$	Square wave input		3.2	4.9	mA
					Resonator connection		3.3	5.0	mA
				$f_{MX} = 20\text{ MHz}$ ^{Note 2} , $V_{DD} = 3.0\text{ V}$	Square wave input		3.2	4.9	mA
					Resonator connection		3.3	5.0	mA
				$f_{MX} = 10\text{ MHz}$ ^{Note 2} , $V_{DD} = 5.0\text{ V}$	Square wave input		2.0	2.9	mA
		Resonator connection				2.0	2.9	mA	
		$f_{MX} = 10\text{ MHz}$ ^{Note 2} , $V_{DD} = 3.0\text{ V}$		Square wave input		2.0	2.9	mA	
				Resonator connection		2.0	2.9	mA	
		LS (low-speed main) mode ^{Note 5}	$f_{MX} = 8\text{ MHz}$ ^{Note 2} , $V_{DD} = 3.0\text{ V}$, $T_A = -40$ to $+85^\circ\text{C}$	Square wave input		1.2	1.8	mA	
				Resonator connection		1.2	1.8	mA	
		HS (high-speed main) mode ^{Note 5}	$f_{IH} = 4\text{ MHz}$ ^{Note 3} $f_{PLL} = 64\text{ MHz}$, $f_{CLK} = 32\text{ MHz}$	$V_{DD} = 5.0\text{ V}$		5.4	8.5	mA	
				$V_{DD} = 3.0\text{ V}$		5.4	8.5	mA	
			$f_{IH} = 4\text{ MHz}$ ^{Note 3} $f_{PLL} = 64\text{ MHz}$, $f_{CLK} = 16\text{ MHz}$	$V_{DD} = 5.0\text{ V}$		3.3	5.7	mA	
				$V_{DD} = 3.0\text{ V}$		3.3	5.7	mA	
		Subsystem clock operation	$f_{SUB} = 32.768\text{ kHz}$ ^{Note 4} $T_A = -40^\circ\text{C}$	Square wave input		4.2	6.0	μA	
				Resonator connection		4.4	6.2	μA	
			$f_{SUB} = 32.768\text{ kHz}$ ^{Note 4} $T_A = +25^\circ\text{C}$	Square wave input		4.2	6.0	μA	
Resonator connection				4.4	6.2	μA			
$f_{SUB} = 32.768\text{ kHz}$ ^{Note 4} $T_A = +50^\circ\text{C}$	Square wave input			4.3	7.2	μA			
	Resonator connection			4.5	7.4	μA			
$f_{SUB} = 32.768\text{ kHz}$ ^{Note 4} $T_A = +70^\circ\text{C}$	Square wave input			4.4	8.1	μA			
	Resonator connection			4.6	8.3	μA			
$f_{SUB} = 32.768\text{ kHz}$ ^{Note 4} $T_A = +85^\circ\text{C}$	Square wave input			5.2	11.4	μA			
	Resonator connection			5.4	11.6	μA			
$f_{SUB} = 32.768\text{ kHz}$ ^{Note 4} $T_A = +105^\circ\text{C}$	Square wave input		6.9	20.8	μA				
	Resonator connection		7.1	21.0	μA				

(Notes and Remarks are listed on the next page.)

- Notes**
1. Total current flowing into V_{DD} , including the input leakage current flowing when the level of the input pin is fixed to V_{DD} or V_{SS} . The values below the MAX. column include the peripheral operation current. However, not including the current flowing into the A/D converter, comparator, programmable gain amplifier, LVD circuit, I/O port, and on-chip pull-up/pull-down resistors and the current flowing during data flash rewrite.
 2. When high-speed on-chip oscillator and subsystem clock are stopped.
 3. When high-speed system clock and subsystem clock are stopped.
 4. When high-speed on-chip oscillator and high-speed system clock are stopped. When AMPHS1 = 1 (Ultra-low power consumption oscillation). However, not including the current flowing into the RTC, 12-bit interval timer, and watchdog timer.
 5. Relationship between operation voltage width, operation frequency of CPU and operation mode is as below.
HS (high-speed main) mode: $2.7\text{ V} \leq V_{DD} \leq 5.5\text{ V}@1\text{ MHz to }32\text{ MHz}$
LS (low-speed main) mode: $2.7\text{ V} \leq V_{DD} \leq 5.5\text{ V}@1\text{ MHz to }8\text{ MHz}$

- Remarks**
1. f_{MX} : High-speed system clock frequency (X1 clock oscillation frequency or external main system clock frequency)
 2. f_{IH} : High-speed on-chip oscillator clock frequency
 3. f_{SUB} : Subsystem clock frequency (XT1 clock oscillation frequency)
 4. Except subsystem clock operation, temperature condition of the TYP. value is $T_A = 25^\circ\text{C}$

$(T_A = -40$ to $+105^\circ\text{C}$, $2.7\text{ V} \leq V_{DD} \leq 5.5\text{ V}$, $V_{SS} = 0\text{ V}$) (2/2)

Parameter	Symbol	Conditions			MIN.	TYP.	MAX.	Unit	
Supply current Note 1	I_{DD2} Note 2	HALT mode	HS (high-speed main) mode Note 7	$f_{IH} = 32\text{ MHz}$ Note 4	$V_{DD} = 5.0\text{ V}$		0.72	2.9	mA
					$V_{DD} = 3.0\text{ V}$		0.72	2.9	mA
				$f_{IH} = 24\text{ MHz}$ Note 4	$V_{DD} = 5.0\text{ V}$		0.57	2.3	mA
					$V_{DD} = 3.0\text{ V}$		0.57	2.3	mA
				$f_{IH} = 16\text{ MHz}$ Note 4	$V_{DD} = 5.0\text{ V}$		0.50	1.7	mA
					$V_{DD} = 3.0\text{ V}$		0.50	1.7	mA
			LS (low-speed main) mode Note 7	$f_{IH} = 8\text{ MHz}$ Note 4, $T_A = -40$ to $+85^\circ\text{C}$	$V_{DD} = 3.0\text{ V}$		320	910	μA
			HS (high-speed main) mode Note 7	$f_{MX} = 20\text{ MHz}$ Note 3, $V_{DD} = 5.0\text{ V}$	Square wave input		0.40	1.9	mA
					Resonator connection		0.50	2.0	mA
				$f_{MX} = 20\text{ MHz}$ Note 3, $V_{DD} = 3.0\text{ V}$	Square wave input		0.40	1.9	mA
					Resonator connection		0.50	2.0	mA
				$f_{MX} = 10\text{ MHz}$ Note 3, $V_{DD} = 5.0\text{ V}$	Square wave input		0.24	1.02	mA
					Resonator connection		0.30	1.08	mA
			$f_{MX} = 10\text{ MHz}$ Note 3, $V_{DD} = 3.0\text{ V}$	Square wave input		0.24	1.02	mA	
		Resonator connection			0.30	1.08	mA		
		LS (low-speed main) mode Note 7	$f_{MX} = 8\text{ MHz}$ Note 3, $V_{DD} = 3.0\text{ V}$, $T_A = -40$ to $+85^\circ\text{C}$	Square wave input		130	720	μA	
				Resonator connection		170	760	μA	
		HS (high-speed main) mode Note 7	$f_{IH} = 4\text{ MHz}$ Note 4 $f_{PLL} = 64\text{ MHz}$, $f_{CLK} = 32\text{ MHz}$	$V_{DD} = 5.0\text{ V}$		1.15	4.0	mA	
				$V_{DD} = 3.0\text{ V}$		1.15	4.0	mA	
			$f_{IH} = 4\text{ MHz}$ Note 4 $f_{PLL} = 64\text{ MHz}$, $f_{CLK} = 16\text{ MHz}$	$V_{DD} = 5.0\text{ V}$		0.95	3.2	mA	
				$V_{DD} = 3.0\text{ V}$		0.95	3.2	mA	
		Subsystem clock operation	$f_{SUB} = 32.768\text{ kHz}$ Note 5 $T_A = -40^\circ\text{C}$	Square wave input		0.28	0.70	μA	
				Resonator connection		0.47	0.89	μA	
			$f_{SUB} = 32.768\text{ kHz}$ Note 5 $T_A = +25^\circ\text{C}$	Square wave input		0.33	0.70	μA	
				Resonator connection		0.52	0.89	μA	
			$f_{SUB} = 32.768\text{ kHz}$ Note 5 $T_A = +50^\circ\text{C}$	Square wave input		0.41	1.90	μA	
				Resonator connection		0.60	2.09	μA	
			$f_{SUB} = 32.768\text{ kHz}$ Note 5 $T_A = +70^\circ\text{C}$	Square wave input		0.54	2.80	μA	
Resonator connection				0.73	2.99	μA			
$f_{SUB} = 32.768\text{ kHz}$ Note 5 $T_A = +85^\circ\text{C}$	Square wave input			1.27	6.10	μA			
	Resonator connection			1.46	6.29	μA			
$f_{SUB} = 32.768\text{ kHz}$ Note 5 $T_A = +105^\circ\text{C}$	Square wave input		3.04	15.5	μA				
	Resonator connection		3.23	15.7	μA				
I_{DD3} Note 6	STOP mode Note 8	$T_A = -40^\circ\text{C}$				0.18	0.50	μA	
		$T_A = +25^\circ\text{C}$				0.23	0.50	μA	
		$T_A = +50^\circ\text{C}$				0.27	1.70	μA	
		$T_A = +70^\circ\text{C}$				0.44	2.60	μA	
		$T_A = +85^\circ\text{C}$				1.17	5.90	μA	
		$T_A = +105^\circ\text{C}$				2.94	15.3	μA	

(Notes and Remarks are listed on the next page.)

- Notes**
1. Total current flowing into V_{DD} , including the input leakage current flowing when the level of the input pin is fixed to V_{DD} or V_{SS} . The values below the MAX. column include the peripheral operation current. However, not including the current flowing into the A/D converter, comparator, programmable gain amplifier, LVD circuit, I/O port, and on-chip pull-up/pull-down resistors and the current flowing during data flash rewrite.
 2. During HALT instruction execution by flash memory.
 3. When high-speed on-chip oscillator and subsystem clock are stopped.
 4. When high-speed system clock and subsystem clock are stopped.
 5. When high-speed on-chip oscillator and high-speed system clock are stopped. When $RTCLPC = 1$ and setting ultra-low current consumption ($AMPHS1 = 1$). The current flowing into the RTC is included. However, not including the current flowing into the 12-bit interval timer and watchdog timer.
 6. Not including the current flowing into the RTC, 12-bit interval timer, and watchdog timer.
 7. Relationship between operation voltage width, operation frequency of CPU and operation mode is as below.
HS (high-speed main) mode: $2.7\text{ V} \leq V_{DD} \leq 5.5\text{ V}@1\text{ MHz to }32\text{ MHz}$
LS (low-speed main) mode: $2.7\text{ V} \leq V_{DD} \leq 5.5\text{ V}@1\text{ MHz to }8\text{ MHz}$
 8. Regarding the value for current operate the subsystem clock in STOP mode, refer to that in HALT mode.

- Remarks**
1. f_{MX} : High-speed system clock frequency (X1 clock oscillation frequency or external main system clock frequency)
 2. f_{IH} : High-speed on-chip oscillator clock frequency
 3. f_{SUB} : Subsystem clock frequency (XT1 clock oscillation frequency)
 4. Except subsystem clock operation and STOP mode, temperature condition of the TYP. value is $T_A = 25^\circ\text{C}$

($T_A = -40$ to $+105^\circ\text{C}$, $2.7\text{ V} \leq V_{DD} \leq 5.5\text{ V}$, $V_{SS} = 0\text{ V}$)

Parameter	Symbol	Conditions		MIN.	TYP.	MAX.	Unit
Low-speed on-chip oscillator operating current	I_{FIL} ^{Note 1}				0.20		μA
RTC operating current	I_{RTC} Notes 1, 2, 3				0.02		μA
12-bit interval timer operating current	I_{IT} Notes 1, 2, 4				0.02		μA
Watchdog timer operating current	I_{WDT} Notes 1, 2, 5	$f_{IL} = 15\text{ kHz}$			0.22		μA
A/D converter operating current	I_{ADC} Notes 1, 6	When conversion at maximum speed	Normal mode, $AV_{REFP} = V_{DD} = 5.0\text{ V}$		1.3	1.7	mA
			Low voltage mode, $AV_{REFP} = V_{DD} = 3.0\text{ V}$		0.5	0.7	mA
A/D converter reference voltage current	I_{ADREF} ^{Note 1}				75.0		μA
Temperature sensor operating current	I_{TMPS} ^{Note 1}				75.0		μA
LVD operating current	I_{LVD} ^{Notes 1, 7}				0.08		μA
Self-programming operating current	I_{FSP} ^{Notes 1, 8}				2.50	12.2	mA
Programmable gain amplifier operating current	I_{PGA} ^{Note 9}				0.21	0.31	mA
					0.18	0.29	mA
Comparator operating current	I_{CMP} ^{Note 10}	When one comparator channel is operating	$AV_{REFP} = V_{DD} = 5.0\text{ V}$		41.4	62	μA
			$AV_{REFP} = V_{DD} = 3.0\text{ V}$		37.2	59	μA
	I_{VREF}	When one internal reference voltage circuit is operating	$AV_{REFP} = V_{DD} = 5.0\text{ V}$		14.8	26	μA
			$AV_{REFP} = V_{DD} = 3.0\text{ V}$		8.9	20	μA
Programmable gain amplifier/comparator reference current source	I_{IREF} ^{Note 11}				3.2	5.1	μA
					2.9	4.9	μA
BGO operating current	I_{BGO} ^{Note 12}				2.50	12.2	mA
SNOOZE operating current	I_{SNOZ} ^{Note 1}	ADC operation	The mode is performed ^{Note 13}		0.50	1.1	mA
			The A/D conversion operations are performed, Standard mode, $AV_{REFP} = V_{DD} = 5.0\text{ V}$		2.0	3.04	mA
		CSI/UART operation			0.70	1.54	mA

(Notes and Remarks are listed on the next page.)

- Notes**
1. Current flowing to the V_{DD} .
 2. When the high-speed on-chip oscillator and high-speed system clock are stopped.
 3. Current flowing only to the real-time clock (RTC) (excluding the operating current of the low-speed on-chip oscillator and the XT1 oscillator). The supply current of the RL78 microcontrollers is the sum of the values of either I_{DD1} or I_{DD2} , and I_{RTC} , when the real-time clock operates in operation mode or HALT mode. When the low-speed on-chip oscillator is selected, I_{FIL} should be added. I_{DD2} subsystem clock operation includes the operational current of the real-time clock.
 4. Current flowing only to the 12-bit interval timer (excluding the operating current of the XT1 oscillator and f_{IL} operating current). The current of the RL78 microcontrollers is the sum of the values of either I_{DD1} or I_{DD2} , and I_{IT} , when the 12-bit interval timer operates in operation mode or HALT mode.
 5. Current flowing only to the watchdog timer (including the operating current of the low-speed on-chip oscillator). The supply current of the RL78 microcontrollers is the sum of I_{DD1} , I_{DD2} or I_{DD3} and I_{WDT} when the watchdog timer is in operation.
 6. Current flowing only to the A/D converter. The supply current of the RL78 microcontrollers is the sum of I_{DD1} or I_{DD2} and I_{ADC} when the A/D converter operates in an operation mode or the HALT mode.
 7. Current flowing only to the LVD circuit. The supply current of the RL78 microcontrollers is the sum of I_{DD1} , I_{DD2} or I_{DD3} and I_{LVD} when the LVD circuit is in operation.
 8. Current flowing during self-programming operation.
 9. Current flowing only to the programmable gain amplifier. The supply current value of the RL78 microcontrollers is the sum of I_{DD1} , I_{DD2} or I_{DD3} , and I_{PGA} , when the programmable gain amplifier is operating in operating mode or in HALT mode.
 10. Current flowing only to the comparator. The supply current value of the RL78 microcontrollers is the sum of I_{DD1} , I_{DD2} or I_{DD3} , and I_{CMP} , when the comparator is operating.
 11. This is the current required to flow to V_{DD} pin of the current circuit that is used as the programmable gain amplifier and the comparator.
 12. Current flowing only during data flash rewrite.
 13. See **21.3.3 SNOOZE mode in the RL78/I1A User's Manual** for shift time to the SNOOZE mode .

- Remarks**
1. f_{IL} : Low-speed on-chip oscillator clock frequency
 2. f_{SUB} : Subsystem clock frequency (XT1 clock oscillation frequency)
 3. f_{CLK} : CPU/peripheral hardware clock frequency
 4. Temperature condition of the TYP. value is $T_A = 25^\circ\text{C}$
 5. Example of calculating current value when using programmable gain amplifier and comparator.
Examples 1) TYP. operating current value when three comparator channels, one internal reference voltage generator, and PGA are operating (when $AV_{REFP} = V_{DD} = 5.0\text{ V}$)

$$\begin{aligned}
 & I_{CMP} \times 3 + I_{VREF} + I_{PGA} + I_{IREF} \\
 &= 41.4 [\mu\text{A}] \times 3 + 14.8 [\mu\text{A}] \times 1 + 210 [\mu\text{A}] + 3.2 [\mu\text{A}] \\
 &= 352.2 [\mu\text{A}]
 \end{aligned}$$

- Examples 2) TYP. operating current value when using two comparator channels, without using internal reference voltage generator (when $AV_{REFP} = V_{DD} = 5.0\text{ V}$)

$$\begin{aligned}
 & I_{CMP} \times 2 + I_{IREF} \\
 &= 41.4 [\mu\text{A}] \times 2 + 3.2 [\mu\text{A}] \\
 &= 86.0 [\mu\text{A}]
 \end{aligned}$$

2.4 AC Characteristics

($T_A = -40$ to $+105^\circ\text{C}$, $2.7\text{ V} \leq V_{DD} \leq 5.5\text{ V}$, $V_{SS} = 0\text{ V}$)

Items	Symbol	Conditions		MIN.	TYP.	MAX.	Unit
Instruction cycle (minimum instruction execution time)	T_{CY}	Main system clock (f_{MAIN}) operation	HS (high-speed main) mode	0.03125		1	μs
			LS (low-speed main) mode	$T_A = -40$ to $+85^\circ\text{C}$	0.125		1
		Subsystem clock (f_{SUB}) operation		28.5	30.5	31.3	μs
		In the self programming mode	HS (high-speed main) mode	0.03125		1	μs
LS (low-speed main) mode	$T_A = -40$ to $+85^\circ\text{C}$		0.125		1	μs	
External system clock frequency	f_{EX}			1.0		20.0	MHz
	f_{EXS}			32		35	kHz
External system clock input high-level width, low-level width	t_{EXH} , t_{EXL}			24			ns
	t_{EXHS} , t_{EXLS}			13.7			μs
Ti03, Ti05, Ti06, Ti07 input high-level width, low-level width	t_{TIH} , t_{TIL}			$2/f_{MCK}+10$			ns
TO03, TO05, TO06, TKBO00, TKBO01, TKBO10, TKBO11, TKBO20, TKBO21, TKCO00 to TKCO05 output frequency (When duty = 50%)	f_{TO}	HS (high-speed main) mode	$4.0\text{ V} \leq V_{DD} \leq 5.5\text{ V}$			8	MHz
			$2.7\text{ V} \leq V_{DD} < 4.0\text{ V}$			4	MHz
		LS (low-speed main) mode, $T_A = -40$ to $+85^\circ\text{C}$	$4.0\text{ V} \leq V_{DD} \leq 5.5\text{ V}$			4	MHz
			$2.7\text{ V} \leq V_{DD} < 4.0\text{ V}$			2	MHz
Interrupt input high-level width, low-level width	t_{INTH} , t_{INTL}	INTP0, INTP3, INTP4, INTP9 to INTP11, INTP20 to INTP23		1			μs
RESET low-level width	t_{RSL}			10			μs

Remark f_{MCK} : Timer array unit operation clock frequency

(Operation clock to be set by the CKS0n bit of timer mode register 0n (TMR0n). n: Channel number (n = 0 to 7))

Minimum Instruction Execution Time during Main System Clock Operation

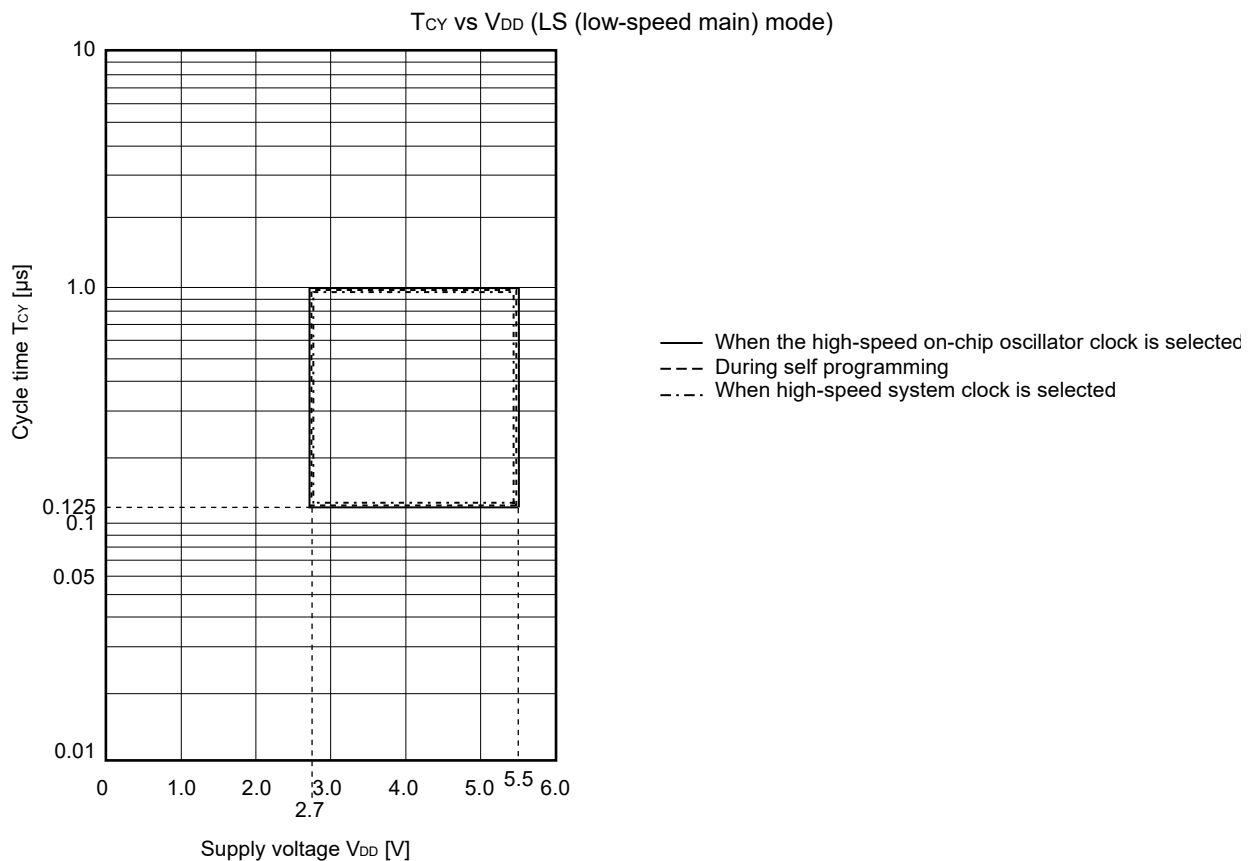
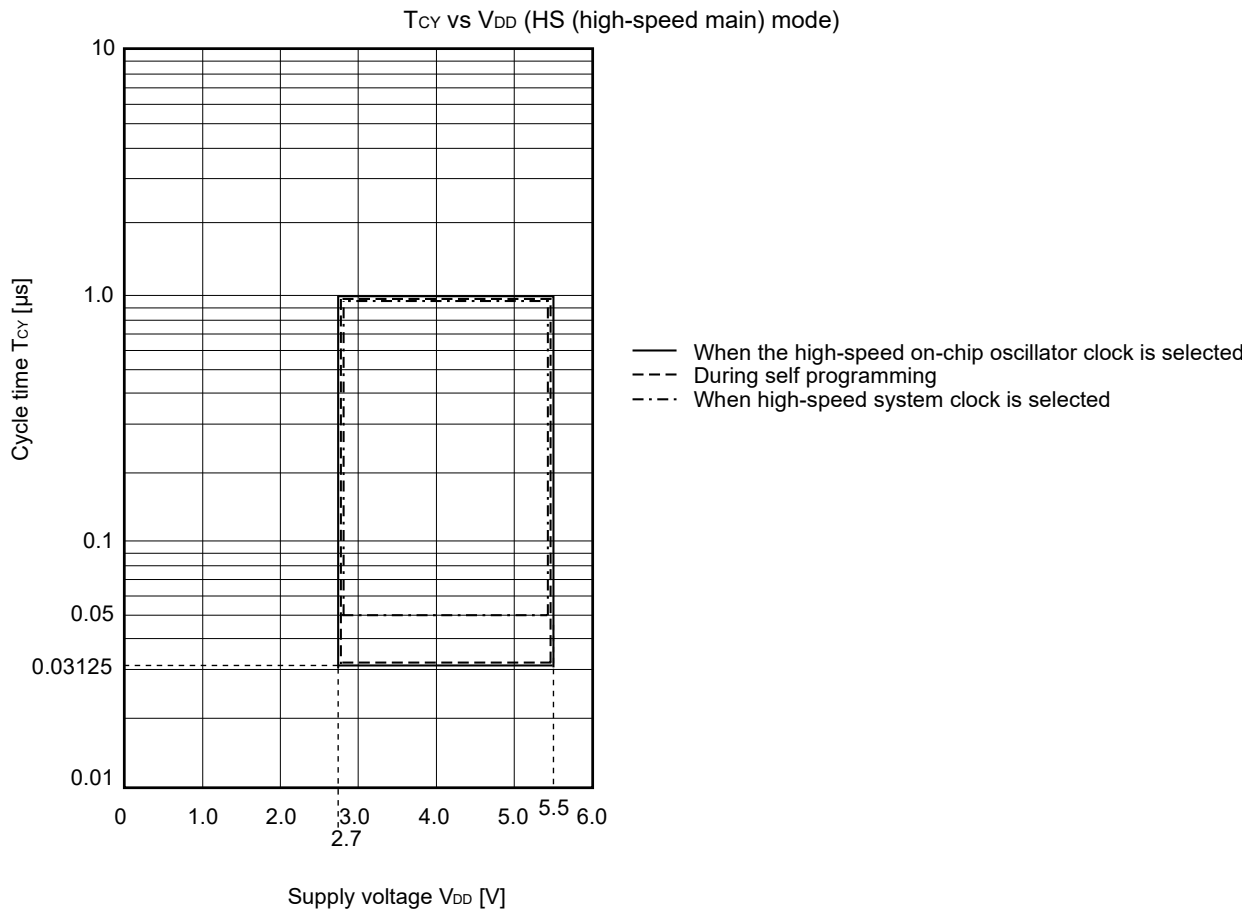

AC Timing Test Points

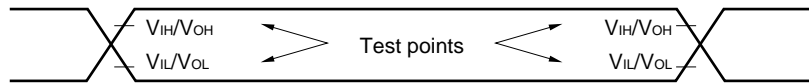

External System Clock Timing

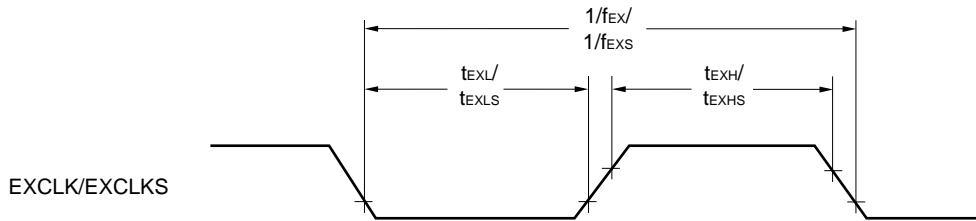

TI/TO Timing

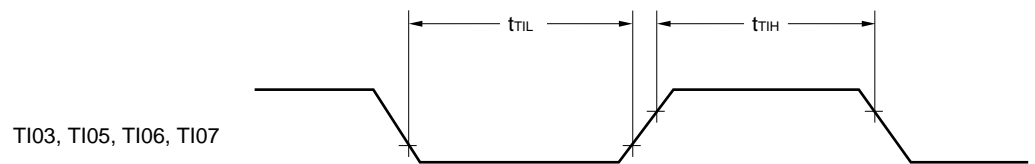

TO03, TO05, TO06, TKBO00, TKBO01, TKBO10, TKBO11, TKBO20, TKBO21, TKCO00 to TKCO05

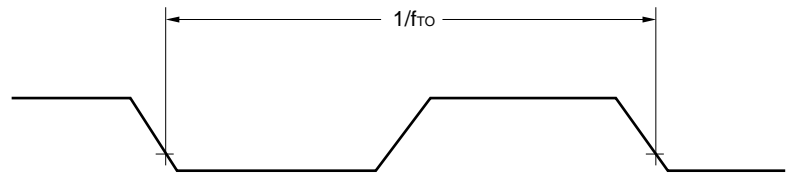

Interrupt Request Input Timing

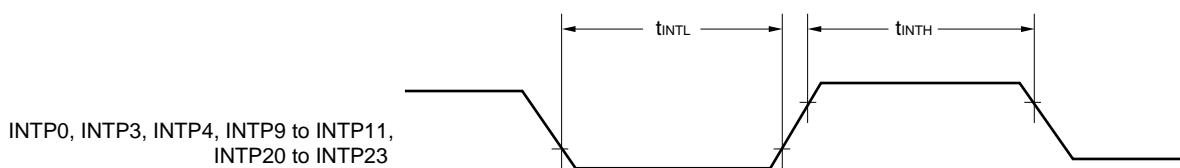

RESET Input Timing

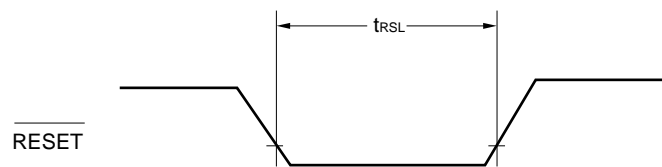

2.5 Peripheral Functions Characteristics

AC Timing Test Points

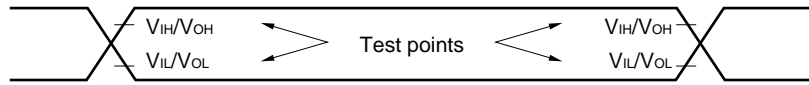

2.5.1 Serial array unit 0, 4 (UART0, UART1, CSI00, DALI/UART4)

(1) During communication at same potential (UART mode)

($T_A = -40$ to $+105^\circ\text{C}$, $2.7\text{ V} \leq V_{DD} \leq 5.5\text{ V}$, $V_{SS} = 0\text{ V}$)

Parameter	Symbol	Conditions	HS (high-speed main) Mode		LS (low-speed main) Mode		Unit
			MIN.	MAX.	MIN.	MAX.	
Transfer rate ^{Note 1}		$2.7\text{ V} \leq V_{DD} \leq 5.5\text{ V}$		$f_{MCK}/6$		$f_{MCK}/6$	bps
			Theoretical value of the maximum transfer rate $f_{MCK} = f_{CLK}$ ^{Note 2}	5.3	1.3	Mbps	

Notes 1. Transfer rate in the SNOOZE mode is 4800 bps only.

2. The maximum operating frequencies of the CPU/peripheral hardware clock (f_{CLK}) are:

HS (high-speed main) mode: 32 MHz ($2.7\text{ V} \leq V_{DD} \leq 5.5\text{ V}$)

LS (low-speed main) mode: 8 MHz ($2.7\text{ V} \leq V_{DD} \leq 5.5\text{ V}$), $T_A = -40$ to $+85^\circ\text{C}$

Caution Select the normal input buffer for the RxDq pin and the normal output mode for the TxDq pin by using port input mode register g (PIMg) and port output mode register g (POMg).

UART mode connection diagram (during communication at same potential)

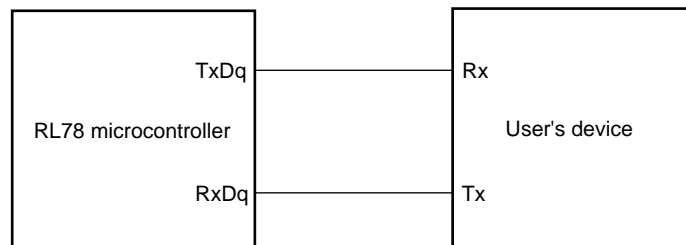

UART mode bit width (during communication at same potential) (reference)

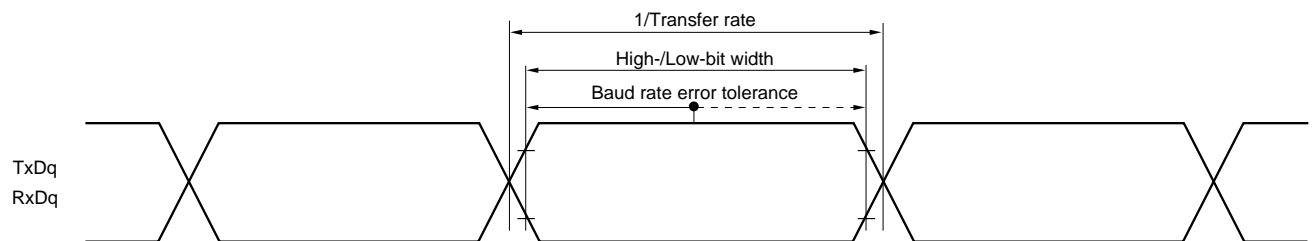

Caution Select the normal input buffer for the RxDq pin and the normal output mode for the TxDq pin by using port input mode register g (PIMg) and port output mode register g (POMg).

Remarks 1. q: UART number (q = 0, 1), g: PIM and POM number (g = 0, 1)

2. f_{MCK} : Serial array unit operation clock frequency

(Operation clock to be set by the CKSmn bit of serial mode register mn (SMRmn). m: Unit number,

n: Channel number (mn = 00 to 03))

(2) During communication at same potential (CSI mode) (master mode, SCKp... internal clock output)**($T_A = -40$ to $+105^\circ\text{C}$ ^{Note 5}, $2.7\text{ V} \leq V_{DD} \leq 5.5\text{ V}$, $V_{SS} = 0\text{ V}$)**

Parameter	Symbol	Conditions	HS (high-speed main) Mode		LS (low-speed main) Mode		Unit
			MIN.	MAX.	MIN.	MAX.	
SCKp cycle time	t_{KCY1}	$t_{KCY1} \geq 4/f_{CLK}$	125		500		ns
SCKp high-/low-level width	t_{KH1} ,	$4.0\text{ V} \leq V_{DD} \leq 5.5\text{ V}$	$t_{KCY1}/2 - 12$		$t_{KCY1}/2 - 50$		ns
	t_{KL1}	$2.7\text{ V} \leq V_{DD} \leq 5.5\text{ V}$	$t_{KCY1}/2 - 18$		$t_{KCY1}/2 - 50$		ns
Slp setup time (to SCKp \uparrow) <small>Note 1</small>	t_{SIK1}	$4.0\text{ V} \leq V_{DD} \leq 5.5\text{ V}$	44		110		ns
		$2.7\text{ V} \leq V_{DD} \leq 5.5\text{ V}$	44		110		ns
Slp hold time (from SCKp \uparrow) <small>Note 2</small>	t_{KSI1}		19		19		ns
Delay time from SCKp \downarrow to SOp output ^{Note 3}	t_{KSO1}	$C = 30\text{ pF}$ ^{Note 4}		25		25	ns

- Notes**
1. When $DAPmn = 0$ and $CKPmn = 0$, or $DAPmn = 1$ and $CKPmn = 1$. The Slp setup time becomes "to SCKp \downarrow " when $DAPmn = 0$ and $CKPmn = 1$, or $DAPmn = 1$ and $CKPmn = 0$.
 2. When $DAPmn = 0$ and $CKPmn = 0$, or $DAPmn = 1$ and $CKPmn = 1$. The Slp hold time becomes "from SCKp \downarrow " when $DAPmn = 0$ and $CKPmn = 1$, or $DAPmn = 1$ and $CKPmn = 0$.
 3. When $DAPmn = 0$ and $CKPmn = 0$, or $DAPmn = 1$ and $CKPmn = 1$. The delay time to SOp output becomes "from SCKp \uparrow " when $DAPmn = 0$ and $CKPmn = 1$, or $DAPmn = 1$ and $CKPmn = 0$.
 4. C is the load capacitance of the SCKp and SOp output lines.
 5. Operating conditions of LS (low-speed main) mode is $T_A = -40$ to $+85^\circ\text{C}$.

Caution Select the normal input buffer for the Slp pin and the normal output mode for the SOp pin and SCKp pin by using port input mode register g (PIMg) and port output mode register g (POMg).

- Remarks**
1. p: CSI number (p = 00), m: Unit number (m = 0), n: Channel number (n = 0),
g: PIM and POM number (g = 1)
 2. f_{MCK} : Serial array unit operation clock frequency
(Operation clock to be set by the CKSmn bit of serial mode register mn (SMRmn). m: Unit number, n: Channel number (mn = 00))

(3) During communication at same potential (CSI mode) (slave mode, SCKp... external clock input)
 (T_A = -40 to +105°C^{Note 6}, 2.7 V ≤ V_{DD} ≤ 5.5 V, V_{SS} = 0 V)

Parameter	Symbol	Conditions		HS (high-speed main) Mode		LS (low-speed main) Mode		Unit
				MIN.	MAX.	MIN.	MAX.	
SCKp cycle time ^{Note 5}	t _{KCY2}	4.0 V ≤ V _{DD} ≤ 5.5 V	20 MHz < f _{MCK}	8/f _{MCK}		-		ns
			f _{MCK} ≤ 20 MHz	6/f _{MCK}		6/f _{MCK}		ns
		2.7 V ≤ V _{DD} ≤ 5.5 V	16 MHz < f _{MCK}	8/f _{MCK}		-		ns
			f _{MCK} ≤ 16 MHz	6/f _{MCK}		6/f _{MCK}		ns
SCKp high-/low-level width	t _{KH2} , t _{KL2}			t _{KCY2} /2		t _{KCY2} /2		ns
Slp setup time (to SCKp↑) ^{Note 1}	t _{SIK2}			1/f _{MCK} +20		1/f _{MCK} +30		ns
Slp hold time (from SCKp↑) ^{Note 2}	t _{SIK2}			1/f _{MCK} +31		1/f _{MCK} +31		ns
Delay time from SCKp↓ to SOp output ^{Note 3}	t _{KSO2}	C = 30 pF ^{Note 4}			2/f _{MCK} +44		2/f _{MCK} +110	ns

- Notes**
1. When DAPmn = 0 and CKPmn = 0, or DAPmn = 1 and CKPmn = 1. The Slp setup time becomes “to SCKp↓” when DAPmn = 0 and CKPmn = 1, or DAPmn = 1 and CKPmn = 0.
 2. When DAPmn = 0 and CKPmn = 0, or DAPmn = 1 and CKPmn = 1. The Slp hold time becomes “from SCKp↓” when DAPmn = 0 and CKPmn = 1, or DAPmn = 1 and CKPmn = 0.
 3. When DAPmn = 0 and CKPmn = 0, or DAPmn = 1 and CKPmn = 1. The delay time to SOp output becomes “from SCKp↑” when DAPmn = 0 and CKPmn = 1, or DAPmn = 1 and CKPmn = 0.
 4. C is the load capacitance of the SOp output lines.
 5. Transfer rate in the SNOOZE mode: MAX. 1 Mbps
 6. Operating conditions of LS (low-speed main) mode is T_A = -40 to +85°C.

Caution Select the normal input buffer for the Slp pin and SCKp pin and the normal output mode for the SOp pin by using port input mode register g (PIMg) and port output mode register g (POMg).

- Remarks**
1. p: CSI number (p = 00), m: Unit number (m = 0), n: Channel number (n = 0),
g: PIM and POM number (g = 1)
 2. f_{MCK}: Serial array unit operation clock frequency
(Operation clock to be set by the CKSmn bit of serial mode register mn (SMRmn). m: Unit number, n: Channel number (mn = 00))

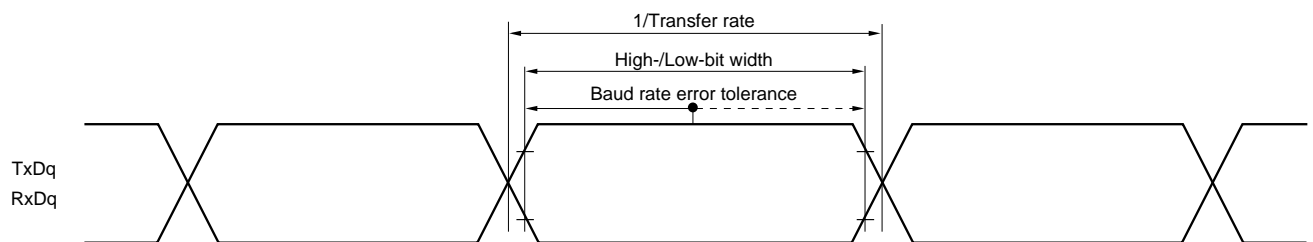

CSI mode connection diagram (during communication at same potential)

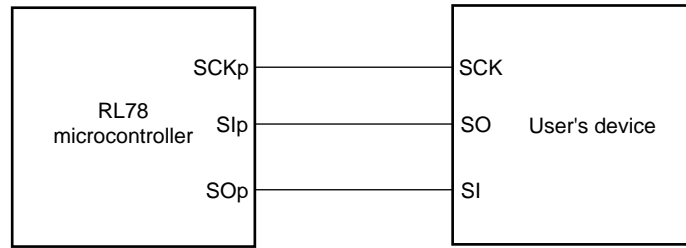

**CSI mode serial transfer timing (during communication at same potential)
(When DAPmn = 0 and CKPmn = 0, or DAPmn = 1 and CKPmn = 1.)**

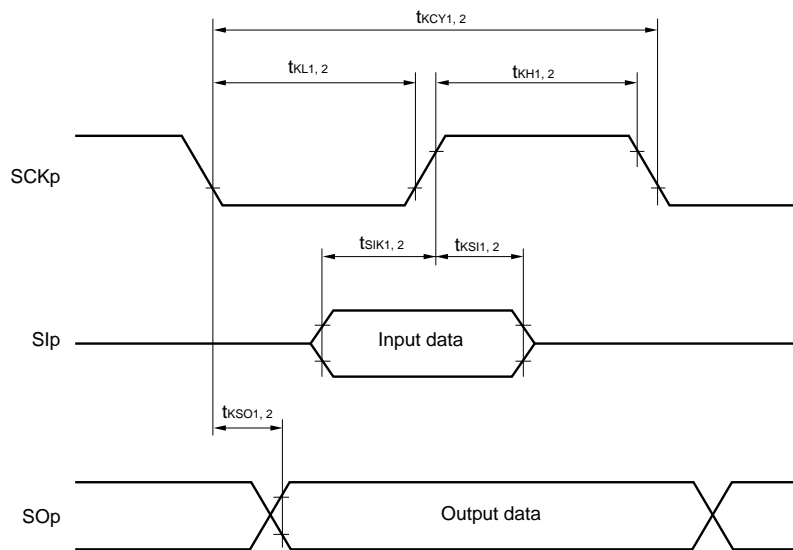

**CSI mode serial transfer timing (during communication at same potential)
(When DAPmn = 0 and CKPmn = 1, or DAPmn = 1 and CKPmn = 0.)**

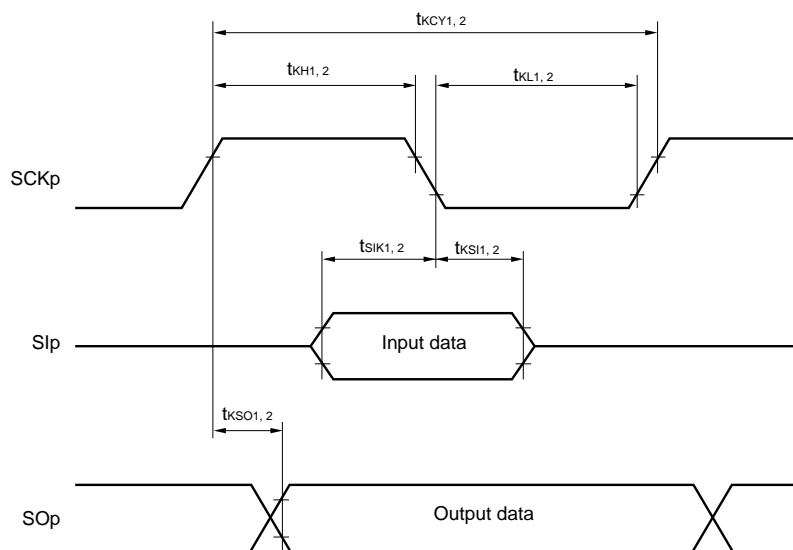

- Remarks 1. p: CSI number (p = 00)
- 2. m: Unit number, n: Channel number (mn = 00)

(4) Communication at different potential (2.5 V, 3 V) (UART mode) (1/2)**($T_A = -40$ to $+105^\circ\text{C}$, $2.7\text{ V} \leq V_{DD} \leq 5.5\text{ V}$, $V_{SS} = 0\text{ V}$)**

Parameter	Symbol	Conditions	HS (high-speed main) Mode		LS (low-speed main) Mode		Unit	
			MIN.	MAX.	MIN.	MAX.		
Transfer rate		Reception	$4.0\text{ V} \leq V_{DD} \leq 5.5\text{ V}$, $2.7\text{ V} \leq V_b \leq 4.0\text{ V}$			$f_{MCK}/6^{\text{Note 1}}$	$f_{MCK}/6^{\text{Note 1}}$	bps
			Theoretical value of the maximum transfer rate $f_{MCK} = f_{CLK}^{\text{Note 2}}$			5.3	1.3	Mbps
		$2.7\text{ V} \leq V_{DD} < 4.0\text{ V}$, $2.3\text{ V} \leq V_b \leq 2.7\text{ V}$			$f_{MCK}/6^{\text{Note 1}}$	$f_{MCK}/6^{\text{Note 1}}$	bps	
		Theoretical value of the maximum transfer rate $f_{MCK} = f_{CLK}^{\text{Note 2}}$			5.3	1.3	Mbps	

Notes 1. Transfer rate in the SNOOZE mode is 4800 bps only.**2.** The maximum operating frequencies of the CPU/peripheral hardware clock (f_{CLK}) are:HS (high-speed main) mode: 32 MHz ($2.7\text{ V} \leq V_{DD} \leq 5.5\text{ V}$)LS (low-speed main) mode: 8 MHz ($2.7\text{ V} \leq V_{DD} \leq 5.5\text{ V}$), $T_A = -40$ to $+85^\circ\text{C}$.

Caution Select the TTL input buffer for the RxDq pin and the N-ch open drain output (V_{DD} tolerance) mode for the TxDq pin by using port input mode register g (PIMg) and port output mode register g (POMg). For V_{IH} and V_{IL} , see the DC characteristics with TTL input buffer selected.

Remarks 1. $V_b[V]$: Communication line voltage**2.** q: UART number (q = 0, 1), g: PIM and POM number (g = 0, 1)**3.** f_{MCK} : Serial array unit operation clock frequency

(Operation clock to be set by the CKSmn bit of serial mode register mn (SMRmn). m: Unit number, n: Channel number (mn = 00 to 03))

(4) Communication at different potential (2.5 V, 3 V) (UART mode) (2/2)(T_A = -40 to +105°C ^{Note 5}, 2.7 V ≤ V_{DD} ≤ 5.5 V, V_{SS} = 0 V)

Parameter	Symbol	Conditions	HS (high-speed main) Mode		LS (low-speed main) Mode		Unit		
			MIN.	MAX.	MIN.	MAX.			
Transfer rate		Transmission	4.0 V ≤ V _{DD} ≤ 5.5 V, 2.7 V ≤ V _b ≤ 4.0 V			Note 1		Note 1	bps
			Theoretical value of the maximum transfer rate C _b = 50 pF, R _b = 1.4 kΩ, V _b = 2.7 V			2.8 ^{Note 2}		2.8 ^{Note 2}	Mbps
		2.7 V ≤ V _{DD} < 4.0 V, 2.3 V ≤ V _b ≤ 2.7 V			Note 3		Note 3	bps	
		Theoretical value of the maximum transfer rate C _b = 50 pF, R _b = 2.7 kΩ, V _b = 2.3 V			1.2 ^{Note 4}		1.2 ^{Note 4}	Mbps	

Notes 1. The smaller maximum transfer rate derived by using f_{MCK}/6 or the following expression is the valid maximum transfer rate.

Expression for calculating the transfer rate when 4.0 V ≤ V_{DD} ≤ 5.5 V and 2.7 V ≤ V_b ≤ 4.0 V

$$\text{Maximum transfer rate} = \frac{1}{\{-C_b \times R_b \times \ln(1 - \frac{2.2}{V_b})\} \times 3} \text{ [bps]}$$

$$\text{Baud rate error (theoretical value)} = \frac{\frac{1}{\text{Transfer rate} \times 2} - \{-C_b \times R_b \times \ln(1 - \frac{2.2}{V_b})\}}{\left(\frac{1}{\text{Transfer rate}}\right) \times \text{Number of transferred bits}} \times 100 \text{ [%]}$$

* This value is the theoretical value of the relative difference between the transmission and reception sides.

- This value as an example is calculated when the conditions described in the "Conditions" column are met. See **Note 1** above to calculate the maximum transfer rate under conditions of the customer.
- The smaller maximum transfer rate derived by using f_{MCK}/6 or the following expression is the valid maximum transfer rate.

Expression for calculating the transfer rate when 2.7 V ≤ V_{DD} < 4.0 V and 2.3 V ≤ V_b ≤ 2.7 V

$$\text{Maximum transfer rate} = \frac{1}{\{-C_b \times R_b \times \ln(1 - \frac{2.0}{V_b})\} \times 3} \text{ [bps]}$$

$$\text{Baud rate error (theoretical value)} = \frac{\frac{1}{\text{Transfer rate} \times 2} - \{-C_b \times R_b \times \ln(1 - \frac{2.0}{V_b})\}}{\left(\frac{1}{\text{Transfer rate}}\right) \times \text{Number of transferred bits}} \times 100 \text{ [%]}$$

* This value is the theoretical value of the relative difference between the transmission and reception sides.

- This value as an example is calculated when the conditions described in the "Conditions" column are met. See **Note 3** above to calculate the maximum transfer rate under conditions of the customer.
- Operating conditions of LS (low-speed main) mode is T_A = -40 to +85°C.

Caution Select the TTL input buffer for the RxDq pin and the N-ch open drain output (V_{DD} tolerance) mode for the TxDq pin by using port input mode register g (PIMg) and port output mode register g (POMg). For V_{IH} and V_{IL}, see the DC characteristics with TTL input buffer selected.

- Remarks 1.** R_b[Ω]: Communication line (TxDq) pull-up resistance,
C_b[F]: Communication line (TxDq) load capacitance, V_b[V]: Communication line voltage
- q: UART number (q = 0, 1), g: PIM and POM number (g = 0, 1)
 - f_{MCK}: Serial array unit operation clock frequency
(Operation clock to be set by the CKSmn bit of serial mode register mn (SMRmn).
m: Unit number, n: Channel number (mn = 00 to 03))

UART mode connection diagram (during communication at different potential)

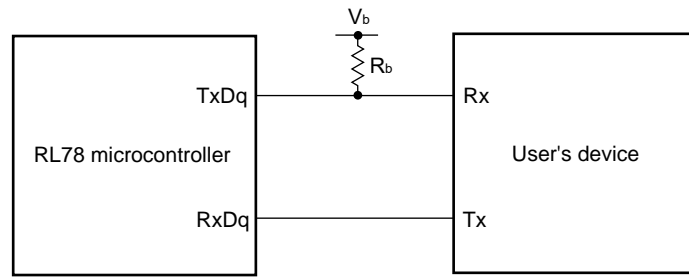

UART mode bit width (during communication at different potential) (reference)

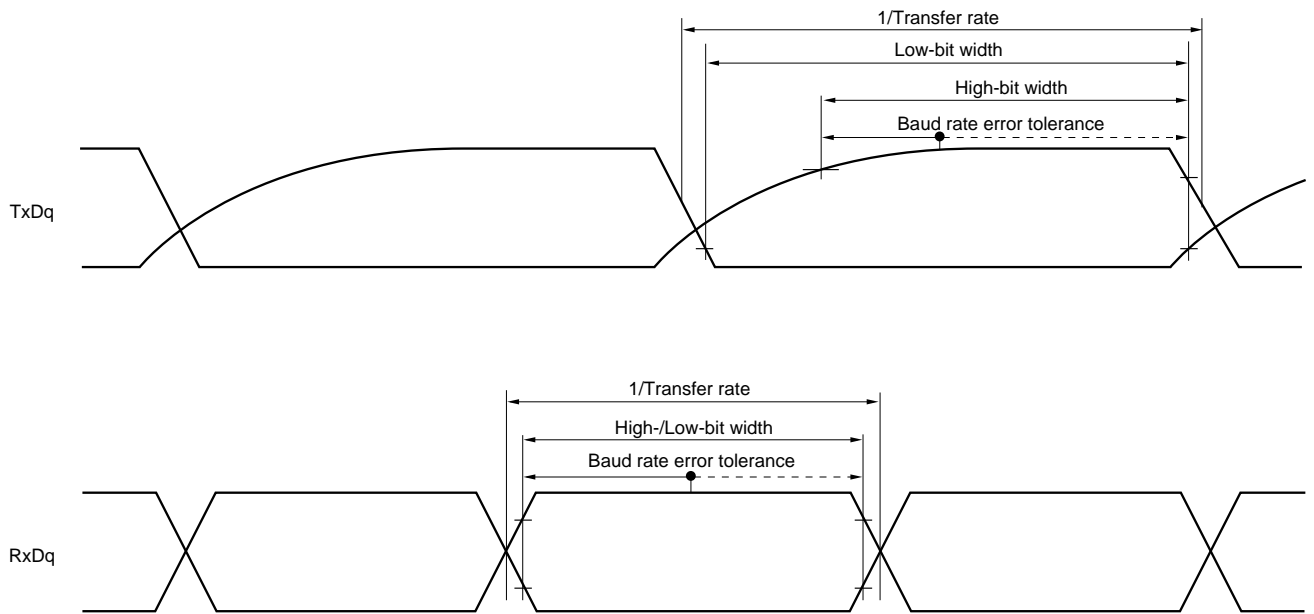

Caution Select the TTL input buffer for the RxDq pin and the N-ch open drain output (V_{DD} tolerance) mode for the TxDq pin by using port input mode register g (PIMg) and port output mode register g (POMg).

- Remarks**
1. $R_b[\Omega]$: Communication line (TxDq) pull-up resistance, $V_b[V]$: Communication line voltage
 2. q: UART number (q = 0, 1), g: PIM and POM number (g = 0, 1)

(5) Communication at different potential (2.5 V, 3 V) (CSI mode) (master mode, SCKp... internal clock output)
($T_A = -40$ to $+105^\circ\text{C}$ ^{Note 3}, $2.7\text{ V} \leq V_{DD} \leq 5.5\text{ V}$, $V_{SS} = 0\text{ V}$)

Parameter	Symbol	Conditions		HS (high-speed main) Mode		LS (low-speed main) Mode		Unit
				MIN.	MAX.	MIN.	MAX.	
SCKp cycle time	t_{KCY1}	$t_{KCY1} \geq 2/f_{CLK}$	$4.0\text{ V} \leq V_{DD} \leq 5.5\text{ V}$, $2.7\text{ V} \leq V_b \leq 4.0\text{ V}$, $C_b = 30\text{ pF}$, $R_b = 1.4\text{ k}\Omega$	200		1150		ns
			$2.7\text{ V} \leq V_{DD} < 4.0\text{ V}$, $2.3\text{ V} \leq V_b \leq 2.7\text{ V}$, $C_b = 30\text{ pF}$, $R_b = 2.7\text{ k}\Omega$	300		1150		ns
SCKp high-level width	t_{KH1}	$4.0\text{ V} \leq V_{DD} \leq 5.5\text{ V}$, $2.7\text{ V} \leq V_b \leq 4.0\text{ V}$, $C_b = 30\text{ pF}$, $R_b = 1.4\text{ k}\Omega$		$t_{KCY1}/2 - 50$		$t_{KCY1}/2 - 75$		ns
			$2.7\text{ V} \leq V_{DD} < 4.0\text{ V}$, $2.3\text{ V} \leq V_b \leq 2.7\text{ V}$, $C_b = 30\text{ pF}$, $R_b = 2.7\text{ k}\Omega$		$t_{KCY1}/2 - 120$		$t_{KCY1}/2 - 170$	
SCKp low-level width	t_{KL1}	$4.0\text{ V} \leq V_{DD} \leq 5.5\text{ V}$, $2.7\text{ V} \leq V_b \leq 4.0\text{ V}$, $C_b = 30\text{ pF}$, $R_b = 1.4\text{ k}\Omega$		$t_{KCY1}/2 - 7$		$t_{KCY1}/2 - 50$		ns
			$2.7\text{ V} \leq V_{DD} < 4.0\text{ V}$, $2.3\text{ V} \leq V_b \leq 2.7\text{ V}$, $C_b = 30\text{ pF}$, $R_b = 2.7\text{ k}\Omega$		$t_{KCY1}/2 - 10$		$t_{KCY1}/2 - 50$	
Slp setup time (to SCKp \uparrow) ^{Note 1}	t_{SIK1}	$4.0\text{ V} \leq V_{DD} \leq 5.5\text{ V}$, $2.7\text{ V} \leq V_b \leq 4.0\text{ V}$, $C_b = 30\text{ pF}$, $R_b = 1.4\text{ k}\Omega$		81		479		ns
			$2.7\text{ V} \leq V_{DD} < 4.0\text{ V}$, $2.3\text{ V} \leq V_b \leq 2.7\text{ V}$, $C_b = 30\text{ pF}$, $R_b = 2.7\text{ k}\Omega$		177		479	
Slp hold time (from SCKp \uparrow) ^{Note 1}	t_{KSI1}	$4.0\text{ V} \leq V_{DD} \leq 5.5\text{ V}$, $2.7\text{ V} \leq V_b \leq 4.0\text{ V}$, $C_b = 30\text{ pF}$, $R_b = 1.4\text{ k}\Omega$		10		19		ns
			$2.7\text{ V} \leq V_{DD} < 4.0\text{ V}$, $2.3\text{ V} \leq V_b \leq 2.7\text{ V}$, $C_b = 30\text{ pF}$, $R_b = 2.7\text{ k}\Omega$		10		19	
Delay time from SCKp \downarrow to SOp output ^{Note 1}	t_{KSO1}	$4.0\text{ V} \leq V_{DD} \leq 5.5\text{ V}$, $2.7\text{ V} \leq V_b \leq 4.0\text{ V}$, $C_b = 30\text{ pF}$, $R_b = 1.4\text{ k}\Omega$			60		100	ns
			$2.7\text{ V} \leq V_{DD} < 4.0\text{ V}$, $2.3\text{ V} \leq V_b \leq 2.7\text{ V}$, $C_b = 30\text{ pF}$, $R_b = 2.7\text{ k}\Omega$			130		195
Slp setup time (to SCKp \downarrow) ^{Note 2}	t_{SIK1}	$4.0\text{ V} \leq V_{DD} \leq 5.5\text{ V}$, $2.7\text{ V} \leq V_b \leq 4.0\text{ V}$, $C_b = 30\text{ pF}$, $R_b = 1.4\text{ k}\Omega$		44		110		ns
			$2.7\text{ V} \leq V_{DD} < 4.0\text{ V}$, $2.3\text{ V} \leq V_b \leq 2.7\text{ V}$, $C_b = 30\text{ pF}$, $R_b = 2.7\text{ k}\Omega$		44		110	
Slp hold time (from SCKp \downarrow) ^{Note 2}	t_{KSI1}	$4.0\text{ V} \leq V_{DD} \leq 5.5\text{ V}$, $2.7\text{ V} \leq V_b \leq 4.0\text{ V}$, $C_b = 30\text{ pF}$, $R_b = 1.4\text{ k}\Omega$		10		19		ns
			$2.7\text{ V} \leq V_{DD} < 4.0\text{ V}$, $2.3\text{ V} \leq V_b \leq 2.7\text{ V}$, $C_b = 30\text{ pF}$, $R_b = 2.7\text{ k}\Omega$		10		19	
Delay time from SCKp \uparrow to SOp output ^{Note 2}	t_{KSO1}	$4.0\text{ V} \leq V_{DD} \leq 5.5\text{ V}$, $2.7\text{ V} \leq V_b \leq 4.0\text{ V}$, $C_b = 30\text{ pF}$, $R_b = 1.4\text{ k}\Omega$			10		25	ns
			$2.7\text{ V} \leq V_{DD} < 4.0\text{ V}$, $2.3\text{ V} \leq V_b \leq 2.7\text{ V}$, $C_b = 30\text{ pF}$, $R_b = 2.7\text{ k}\Omega$			10		25

- Notes**
1. When $DAPmn = 0$ and $CKPmn = 0$, or $DAPmn = 1$ and $CKPmn = 1$.
 2. When $DAPmn = 0$ and $CKPmn = 1$, or $DAPmn = 1$ and $CKPmn = 0$.
 3. Operating conditions of LS (low-speed main) mode is $T_A = -40$ to $+85^\circ\text{C}$.

Caution Select the TTL input buffer for the Slp pin and the N-ch open drain output (V_{DD} tolerance) mode for the SOp pin and SCKp pin by using port input mode register g (PIMg) and port output mode register g (POMg). For V_{IH} and V_{IL} , see the DC characteristics with TTL input buffer selected.

- Remarks**
1. $R_b[\Omega]$: Communication line (SCKp, SOp) pull-up resistance, $C_b[\text{F}]$: Communication line (SCKp, SOp) load capacitance, $V_b[\text{V}]$: Communication line voltage
 2. p: CSI number (p = 00), m: Unit number (m = 0), n: Channel number (n = 0), g: PIM and POM number (g = 1)

(6) Communication at different potential (2.5 V, 3 V) (CSI mode) (master mode, SCKp... internal clock output)**($T_A = -40$ to $+105^\circ\text{C}$ ^{Note 3}, $2.7\text{ V} \leq V_{DD} \leq 5.5\text{ V}$, $V_{SS} = 0\text{ V}$)**

Parameter	Symbol	Conditions	HS (high-speed main) Mode		LS (low-speed main) Mode		Unit
			MIN.	MAX.	MIN.	MAX.	
SCKp cycle time	t_{KCY1}	$t_{KCY1} \geq 4/f_{CLK}$ $4.0\text{ V} \leq V_{DD} \leq 5.5\text{ V}$, $2.7\text{ V} \leq V_b \leq 4.0\text{ V}$, $C_b = 30\text{ pF}$, $R_b = 1.4\text{ k}\Omega$	300		1150		ns
			500		1150		ns
SCKp high-level width	t_{KH1}	$4.0\text{ V} \leq V_{DD} \leq 5.5\text{ V}$, $2.7\text{ V} \leq V_b \leq 4.0\text{ V}$, $C_b = 30\text{ pF}$, $R_b = 1.4\text{ k}\Omega$	$t_{KCY1}/2 - 75$		$t_{KCY1}/2 - 75$		ns
		$2.7\text{ V} \leq V_{DD} < 4.0\text{ V}$, $2.3\text{ V} \leq V_b \leq 2.7\text{ V}$, $C_b = 30\text{ pF}$, $R_b = 2.7\text{ k}\Omega$	$t_{KCY1}/2 - 170$		$t_{KCY1}/2 - 170$		ns
SCKp low-level width	t_{KL1}	$4.0\text{ V} \leq V_{DD} \leq 5.5\text{ V}$, $2.7\text{ V} \leq V_b \leq 4.0\text{ V}$, $C_b = 30\text{ pF}$, $R_b = 1.4\text{ k}\Omega$	$t_{KCY1}/2 - 12$		$t_{KCY1}/2 - 50$		ns
		$2.7\text{ V} \leq V_{DD} < 4.0\text{ V}$, $2.3\text{ V} \leq V_b \leq 2.7\text{ V}$, $C_b = 30\text{ pF}$, $R_b = 2.7\text{ k}\Omega$	$t_{KCY1}/2 - 18$		$t_{KCY1}/2 - 50$		ns
Slp setup time (to SCKp \uparrow) ^{Note 1}	t_{SIK1}	$4.0\text{ V} \leq V_{DD} \leq 5.5\text{ V}$, $2.7\text{ V} \leq V_b \leq 4.0\text{ V}$, $C_b = 30\text{ pF}$, $R_b = 1.4\text{ k}\Omega$	81		479		ns
		$2.7\text{ V} \leq V_{DD} < 4.0\text{ V}$, $2.3\text{ V} \leq V_b \leq 2.7\text{ V}$, $C_b = 30\text{ pF}$, $R_b = 2.7\text{ k}\Omega$	177		479		ns
Slp hold time (from SCKp \uparrow) ^{Note 1}	t_{SH1}	$4.0\text{ V} \leq V_{DD} \leq 5.5\text{ V}$, $2.7\text{ V} \leq V_b \leq 4.0\text{ V}$, $C_b = 30\text{ pF}$, $R_b = 1.4\text{ k}\Omega$	19		19		ns
		$2.7\text{ V} \leq V_{DD} < 4.0\text{ V}$, $2.3\text{ V} \leq V_b \leq 2.7\text{ V}$, $C_b = 30\text{ pF}$, $R_b = 2.7\text{ k}\Omega$	19		19		ns
Delay time from SCKp \downarrow to SOP output ^{Note 1}	t_{SO1}	$4.0\text{ V} \leq V_{DD} \leq 5.5\text{ V}$, $2.7\text{ V} \leq V_b \leq 4.0\text{ V}$, $C_b = 30\text{ pF}$, $R_b = 1.4\text{ k}\Omega$		100		100	ns
		$2.7\text{ V} \leq V_{DD} < 4.0\text{ V}$, $2.3\text{ V} \leq V_b \leq 2.7\text{ V}$, $C_b = 30\text{ pF}$, $R_b = 2.7\text{ k}\Omega$		195		195	ns
Slp setup time (to SCKp \downarrow) ^{Note 2}	t_{SIK1}	$4.0\text{ V} \leq V_{DD} \leq 5.5\text{ V}$, $2.7\text{ V} \leq V_b \leq 4.0\text{ V}$, $C_b = 30\text{ pF}$, $R_b = 1.4\text{ k}\Omega$	44		110		ns
		$2.7\text{ V} \leq V_{DD} < 4.0\text{ V}$, $2.3\text{ V} \leq V_b \leq 2.7\text{ V}$, $C_b = 30\text{ pF}$, $R_b = 2.7\text{ k}\Omega$	44		110		ns
Slp hold time (from SCKp \downarrow) ^{Note 2}	t_{SH1}	$4.0\text{ V} \leq V_{DD} \leq 5.5\text{ V}$, $2.7\text{ V} \leq V_b \leq 4.0\text{ V}$, $C_b = 30\text{ pF}$, $R_b = 1.4\text{ k}\Omega$	19		19		ns
		$2.7\text{ V} \leq V_{DD} < 4.0\text{ V}$, $2.3\text{ V} \leq V_b \leq 2.7\text{ V}$, $C_b = 30\text{ pF}$, $R_b = 2.7\text{ k}\Omega$	19		19		ns
Delay time from SCKp \uparrow to SOP output ^{Note 2}	t_{SO1}	$4.0\text{ V} \leq V_{DD} \leq 5.5\text{ V}$, $2.7\text{ V} \leq V_b \leq 4.0\text{ V}$, $C_b = 30\text{ pF}$, $R_b = 1.4\text{ k}\Omega$		25		25	ns
		$2.7\text{ V} \leq V_{DD} < 4.0\text{ V}$, $2.3\text{ V} \leq V_b \leq 2.7\text{ V}$, $C_b = 30\text{ pF}$, $R_b = 2.7\text{ k}\Omega$		25		25	ns

- Notes**
1. When $DAPmn = 0$ and $CKPmn = 0$, or $DAPmn = 1$ and $CKPmn = 1$.
 2. When $DAPmn = 0$ and $CKPmn = 1$, or $DAPmn = 1$ and $CKPmn = 0$.
 3. Operating conditions of LS (low-speed main) mode is $T_A = -40$ to $+85^\circ\text{C}$.

(Caution and Remarks are listed on the next page.)

Caution Select the TTL input buffer for the SIp pin and the N-ch open drain output (V_{DD} tolerance) mode for the SOp pin and SCKp pin by using port input mode register g (PIMg) and port output mode register g (POMg). For V_{IH} and V_{IL} , see the DC characteristics with TTL input buffer selected.

CSI mode connection diagram (during communication at different potential)

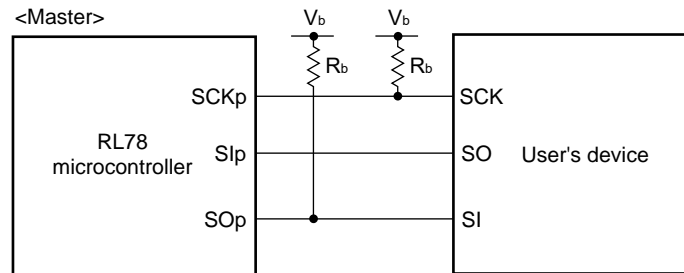

- Remarks**
- $R_b[\Omega]$: Communication line (SCKp, SOp) pull-up resistance, $C_b[\text{F}]$: Communication line (SCKp, SOp) load capacitance, $V_b[\text{V}]$: Communication line voltage
 - p: CSI number (p = 00), m: Unit number (m = 0), n: Channel number (n = 0), g: PIM and POM number (g = 1)

**CSI mode serial transfer timing (master mode) (during communication at different potential)
(When DAPmn = 0 and CKPmn = 0, or DAPmn = 1 and CKPmn = 1.)**

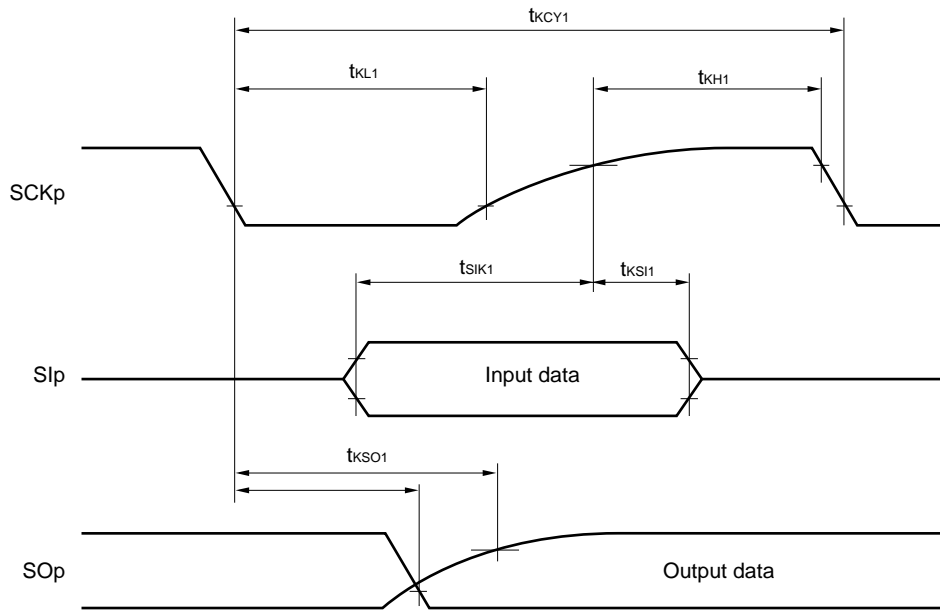

**CSI mode serial transfer timing (master mode) (during communication at different potential)
(When DAPmn = 0 and CKPmn = 1, or DAPmn = 1 and CKPmn = 0.)**

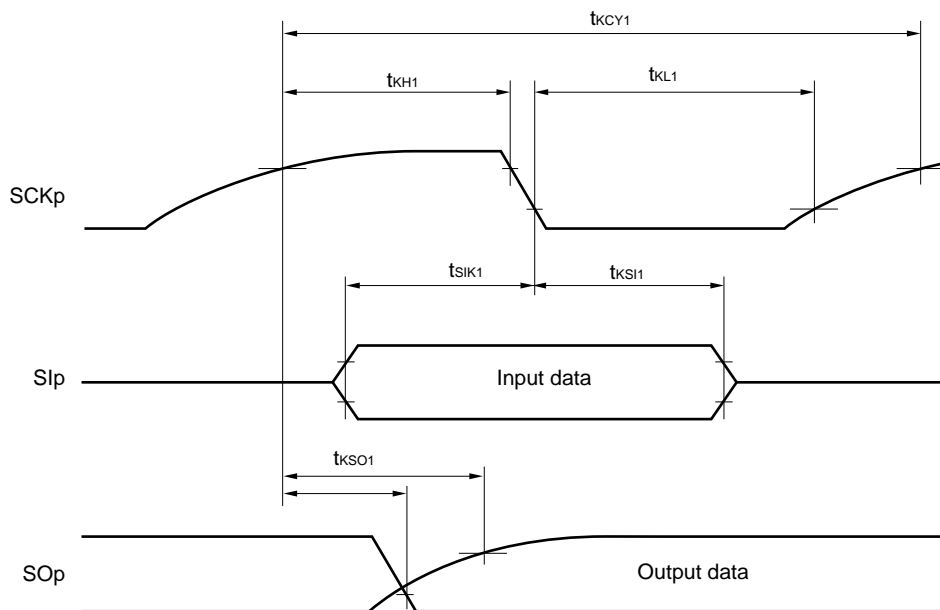

Caution Select the TTL input buffer for the Slp pin and the N-ch open drain output (V_{DD} tolerance) mode for the SOp pin and SCKp pin by using port input mode register g (PIMg) and port output mode register g (POMg).

Remark p: CSI number (p = 00), m: Unit number (m = 0), n: Channel number (n = 0), g: PIM and POM number (g = 1)

(7) DALI/UART4 mode

 $(T_A = -40$ to $+105^\circ\text{C}$, $2.7\text{ V} \leq V_{DD} \leq 5.5\text{ V}$, $V_{SS} = 0\text{ V})$

Parameter	Symbol	Conditions	HS (high-speed main) Mode		LS (low-speed main) Mode		Unit
			MIN.	MAX.	MIN.	MAX.	
Transfer rate				$f_{MCK}/12$		$f_{MCK}/12$	bps
		Maximum transfer rate theoretical value HS: $f_{CLK} = 32\text{ MHz}$, $f_{MCK} = f_{CLK}$ LS: $f_{CLK} = 8\text{ MHz}$, $f_{MCK} = f_{CLK}$		2.6		0.6	Mbps

Remark f_{MCK} : Operation clock frequency of DALI/UART.

(Operation clock to be set by the serial clock select register mn (SPS4).)

Caution Operating conditions of LS (low-speed main) mode is $T_A = -40$ to $+85^\circ\text{C}$.

2.5.2 Serial interface IICA

(1) I²C standard mode(T_A = -40 to $+105^\circ\text{C}$ ^{Note 3}, $2.7\text{ V} \leq V_{DD} \leq 5.5\text{ V}$, $V_{SS} = 0\text{ V}$)

Parameter	Symbol	Conditions	HS (high-speed main) Mode		LS (low-speed main) Mode		Unit
			MIN.	MAX.	MIN.	MAX.	
SCLA0 clock frequency	f _{SCL}	Standard mode: f _{CLK} ≥ 1 MHz	0	100	0	100	kHz
Setup time of restart condition	t _{SU:STA}		4.7		4.7		μs
Hold time ^{Note 1}	t _{HD:STA}		4.0		4.0		μs
Hold time when SCLA0 = "L"	t _{LOW}		4.7		4.7		μs
Hold time when SCLA0 = "H"	t _{HIGH}		4.0		4.0		μs
Data setup time (reception)	t _{SU:DAT}		250		250		ns
Data hold time (transmission) ^{Note 2}	t _{HD:DAT}		0	3.45	0	3.45	μs
Setup time of stop condition	t _{SU:STO}		4.0		4.0		μs
Bus-free time	t _{BUF}		4.7		4.7		μs

- Notes**
1. The first clock pulse is generated after this period when the start/restart condition is detected.
 2. The maximum value (MAX.) of t_{HD:DAT} is during normal transfer and a wait state is inserted in the ACK (acknowledge) timing.
 3. Operating conditions of LS (low-speed main) mode is T_A = -40 to $+85^\circ\text{C}$.

Remark The maximum value of C_b (communication line capacitance) and the value of R_b (communication line pull-up resistor) at that time in each mode are as follows.

Standard mode: C_b = 400 pF, R_b = 2.7 kΩ

(2) I²C fast mode

($T_A = -40$ to $+105^\circ\text{C}$ ^{Note 3}, $2.7\text{ V} \leq V_{DD} \leq 5.5\text{ V}$, $V_{SS} = 0\text{ V}$)

Parameter	Symbol	Conditions	HS (high-speed main) Mode		LS (low-speed main) Mode		Unit
			MIN.	MAX.	MIN.	MAX.	
SCLA0 clock frequency	f_{SCL}	fast mode: $f_{CLK} \geq 3.5\text{ MHz}$	0	400	0	400	kHz
Setup time of restart condition	$t_{SU:STA}$		0.6		0.6		μs
Hold time ^{Note 1}	$t_{HD:STA}$		0.6		0.6		μs
Hold time when SCLA0 = "L"	t_{LOW}		1.3		1.3		μs
Hold time when SCLA0 = "H"	t_{HIGH}		0.6		0.6		μs
Data setup time (reception)	$t_{SU:DAT}$		100		100		ns
Data hold time (transmission) ^{Note 2}	$t_{HD:DAT}$		0	0.9	0	0.9	μs
Setup time of stop condition	$t_{SU:STO}$		0.6		0.6		μs
Bus-free time	t_{BUF}		1.3		1.3		μs

- Notes**
1. The first clock pulse is generated after this period when the start/restart condition is detected.
 2. The maximum value (MAX.) of $t_{HD:DAT}$ is during normal transfer and a wait state is inserted in the ACK (acknowledge) timing.
 3. Operating conditions of LS (low-speed main) mode is $T_A = -40$ to $+85^\circ\text{C}$.

Remark The maximum value of C_b (communication line capacitance) and the value of R_b (communication line pull-up resistor) at that time in each mode are as follows.

Fast mode: $C_b = 320\text{ pF}$, $R_b = 1.1\text{ k}\Omega$

I²C serial transfer timing

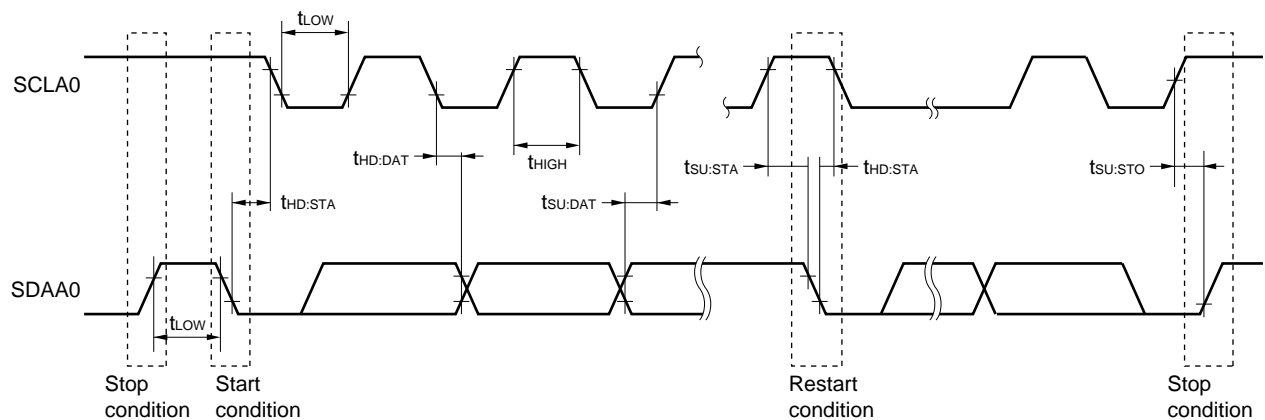

2.6 Analog Characteristics

2.6.1 A/D converter characteristics

Classification of A/D converter characteristics

Input channel	Reference Voltage		
	Reference voltage (+) = AV_{REFP} Reference voltage (-) = AV_{REFM}	Reference voltage (+) = V_{DD} Reference voltage (-) = V_{SS}	Reference voltage (+) = V_{BGR} Reference voltage (-) = AV_{REFM}
ANI0 to ANI2, ANI4 to ANI7	See 2.6.1 (1) .	See 2.6.1 (3) .	See 2.6.1 (4) .
ANI16 to ANI19	See 2.6.1 (2) .		
Internal reference voltage Temperature sensor output voltage	See 2.6.1 (1) .		–

(1) When reference voltage (+) = $AV_{REFP}/ANI0$ ($ADREFP1 = 0$, $ADREFP0 = 1$), reference voltage (-) = $AV_{REFM}/ANI1$ ($ADREFM = 1$), target pin: ANI2, ANI4 to ANI7, internal reference voltage, and temperature sensor output voltage

($T_A = -40$ to $+105^\circ\text{C}$, $2.7\text{ V} \leq AV_{REFP} \leq V_{DD} \leq 5.5\text{ V}$, $V_{SS} = 0\text{ V}$, Reference voltage (+) = AV_{REFP} , Reference voltage (-) = $AV_{REFM} = 0\text{ V}$)

Parameter	Symbol	Conditions	MIN.	TYP.	MAX.	Unit	
Resolution	RES		8		10	bit	
Overall error ^{Note 1}	AINL	10-bit resolution $AV_{REFP} = V_{DD}$ ^{Note 3}		1.2	± 3.5	LSB	
Conversion time	t_{CONV}	10-bit resolution Target pin: ANI2, ANI4 to ANI7	$3.6\text{ V} \leq V_{DD} \leq 5.5\text{ V}$	2.125		39	μs
			$2.7\text{ V} \leq V_{DD} \leq 5.5\text{ V}$	3.1875		39	μs
		10-bit resolution Target pin: Internal reference voltage, and temperature sensor output voltage (HS (high-speed main) mode)	$3.6\text{ V} \leq V_{DD} \leq 5.5\text{ V}$	2.375		39	μs
			$2.7\text{ V} \leq V_{DD} \leq 5.5\text{ V}$	3.5625		39	μs
Zero-scale error ^{Notes 1, 2}	E _{ZS}	10-bit resolution $AV_{REFP} = V_{DD}$ ^{Note 3}			± 0.25	%FSR	
Full-scale error ^{Notes 1, 2}	E _{FS}	10-bit resolution $AV_{REFP} = V_{DD}$ ^{Note 3}			± 0.25	%FSR	
Integral linearity error ^{Note 1}	ILE	10-bit resolution $AV_{REFP} = V_{DD}$ ^{Note 3}			± 2.5	LSB	
Differential linearity error ^{Note 1}	DLE	10-bit resolution $AV_{REFP} = V_{DD}$ ^{Note 3}			± 1.5	LSB	
Analog input voltage	V _{AIN}	ANI2, ANI4 to ANI7	0		AV_{REFP}	V	
		Internal reference voltage (HS (high-speed main) mode)	V_{BGR} ^{Note 4}			V	
		Temperature sensor output voltage (HS (high-speed main) mode)	V_{TMS25} ^{Note 4}			V	

Notes 1. Excludes quantization error ($\pm 1/2$ LSB).

2. This value is indicated as a ratio (%FSR) to the full-scale value.

3. When $AV_{REFP} < V_{DD}$, the MAX. values are as follows.

Overall error: Add ± 1.0 LSB to the MAX. value when $AV_{REFP} = V_{DD}$.

Zero-scale error/Full-scale error: Add $\pm 0.05\%$ FSR to the MAX. value when $AV_{REFP} = V_{DD}$.

Integral linearity error/Differential linearity error: Add ± 0.5 LSB to the MAX. value when $AV_{REFP} = V_{DD}$.

4. See 2.6.2 Temperature sensor/internal reference voltage characteristics.

(2) When reference voltage (+) = $AV_{REFP}/ANI0$ ($ADREFP1 = 0$, $ADREFP0 = 1$), reference voltage (-) = $AV_{REFM}/ANI1$ ($ADREFM = 1$), target pin: ANI16 to ANI19

($T_A = -40$ to $+105^\circ\text{C}$, $2.7\text{ V} \leq AV_{REFP} \leq V_{DD} \leq 5.5\text{ V}$, $V_{SS} = 0\text{ V}$, Reference voltage (+) = AV_{REFP} , Reference voltage (-) = $AV_{REFM} = 0\text{ V}$)

Parameter	Symbol	Conditions	MIN.	TYP.	MAX.	Unit
Resolution	RES		8		10	bit
Overall error ^{Note 1}	AINL	10-bit resolution $AV_{REFP} = V_{DD}$ ^{Notes 3}		1.2	± 5.0	LSB
Conversion time	t_{CONV}	10-bit resolution Target ANI pin : ANI16 to ANI19	$3.6\text{ V} \leq V_{DD} \leq 5.5\text{ V}$	2.125	39	μs
			$2.7\text{ V} \leq V_{DD} \leq 5.5\text{ V}$	3.1875	39	μs
Zero-scale error ^{Notes 1, 2}	E _{ZS}	10-bit resolution $AV_{REFP} = V_{DD}$ ^{Notes 3}			± 0.35	%FSR
Full-scale error ^{Notes 1, 2}	E _{FS}	10-bit resolution $AV_{REFP} = V_{DD}$ ^{Notes 3}			± 0.35	%FSR
Integral linearity error ^{Note 1}	ILE	10-bit resolution $AV_{REFP} = V_{DD}$ ^{Notes 3}			± 3.5	LSB
Differential linearity error ^{Note 1}	DLE	10-bit resolution $AV_{REFP} = V_{DD}$ ^{Notes 3}			± 2.0	LSB
Analog input voltage	V _{AIN}	ANI16 to ANI19	0		AV_{REFP} and V_{DD}	V

Notes 1. Excludes quantization error ($\pm 1/2$ LSB).

2. This value is indicated as a ratio (%FSR) to the full-scale value.

3. When $AV_{REFP} < V_{DD}$, the MAX. values are as follows.

Overall error: Add ± 1.0 LSB to the MAX. value when $AV_{REFP} = V_{DD}$.

Zero-scale error/Full-scale error: Add $\pm 0.05\%$ FSR to the MAX. value when $AV_{REFP} = V_{DD}$.

Integral linearity error/Differential linearity error: Add ± 0.5 LSB to the MAX. value when $AV_{REFP} = V_{DD}$.

- (3) When reference voltage (+) = V_{DD} (ADREFP1 = 0, ADREFP0 = 0), reference voltage (-) = V_{SS} (ADREFM = 0), target pin: ANI0 to ANI2, ANI4 to ANI7, ANI16 to ANI19, internal reference voltage, and temperature sensor output voltage

($T_A = -40$ to $+105^\circ\text{C}$, $2.7\text{ V} \leq V_{DD} \leq 5.5\text{ V}$, $V_{SS} = 0\text{ V}$, Reference voltage (+) = V_{DD} , Reference voltage (-) = V_{SS})

Parameter	Symbol	Conditions	MIN.	TYP.	MAX.	Unit
Resolution	RES		8		10	bit
Overall error ^{Note 1}	AINL	10-bit resolution		1.2	± 7.0	LSB
Conversion time	t_{CONV}	10-bit resolution Target pin: ANI0 to ANI2, ANI4 to ANI7, ANI16 to ANI19	$3.6\text{ V} \leq V_{DD} \leq 5.5\text{ V}$	2.125	39	μs
			$2.7\text{ V} \leq V_{DD} \leq 5.5\text{ V}$	3.1875	39	μs
Conversion time	t_{CONV}	10-bit resolution Target pin: Internal reference voltage, and temperature sensor output voltage (HS (high-speed main) mode)	$3.6\text{ V} \leq V_{DD} \leq 5.5\text{ V}$	2.375	39	μs
			$2.7\text{ V} \leq V_{DD} \leq 5.5\text{ V}$	3.5625	39	μs
Zero-scale error ^{Notes 1, 2}	E _{ZS}	10-bit resolution			± 0.60	%FSR
Full-scale error ^{Notes 1, 2}	E _{FS}	10-bit resolution			± 0.60	%FSR
Integral linearity error ^{Note 1}	ILE	10-bit resolution			± 4.0	LSB
Differential linearity error ^{Note 1}	DLE	10-bit resolution			± 2.0	LSB
Analog input voltage	V_{AIN}	ANI0 to ANI2, ANI4 to ANI7	0		V_{DD}	V
		ANI16 to ANI19	0		V_{DD}	V
		Internal reference voltage (HS (high-speed main) mode)	V_{BGR} ^{Note 3}			V
		Temperature sensor output voltage (HS (high-speed main) mode)	V_{TMPS25} ^{Note 3}			V

Notes 1. Excludes quantization error ($\pm 1/2$ LSB).

2. This value is indicated as a ratio (%FSR) to the full-scale value.

3. See 2.6.2 Temperature sensor/internal reference voltage characteristics.

- (4) When reference voltage (+) = Internal reference voltage (ADREFP1 = 1, ADREFP0 = 0), reference voltage (-) = $AV_{REFM}/ANI1$ (ADREFM = 1), target pin: ANI0, ANI2, ANI4 to ANI7, ANI16 to ANI19

($T_A = -40$ to $+105^\circ\text{C}$, $2.7\text{ V} \leq V_{DD} \leq 5.5\text{ V}$, $V_{SS} = 0\text{ V}$, Reference voltage (+) = $V_{BGR}^{\text{Note 3}}$, Reference voltage (-) = $AV_{REFM} = 0\text{ V}^{\text{Note 4}}$, HS (high-speed main) mode)

Parameter	Symbol	Conditions	MIN.	TYP.	MAX.	Unit
Resolution	RES		8			bit
Conversion time	t_{CONV}	8-bit resolution	17		39	μs
Zero-scale error ^{Notes 1, 2}	E_{ZS}	8-bit resolution			± 0.60	%FSR
Integral linearity error ^{Note 1}	ILE	8-bit resolution			± 2.0	LSB
Differential linearity error ^{Note 1}	DLE	8-bit resolution			± 1.0	LSB
Analog input voltage	V_{AIN}		0		$V_{BGR}^{\text{Note 3}}$	V

Notes 1. Excludes quantization error ($\pm 1/2$ LSB).

2. This value is indicated as a ratio (%FSR) to the full-scale value.

3. See 2.6.2 Temperature sensor/internal reference voltage characteristics.

4. When reference voltage (-) = V_{SS} , the MAX. values are as follows.

Zero-scale error: Add $\pm 0.35\%$ FSR to the MAX. value when reference voltage (-) = AV_{REFM} .

Integral linearity error: Add ± 0.5 LSB to the MAX. value when reference voltage (-) = AV_{REFM} .

Differential linearity error: Add ± 0.2 LSB to the MAX. value when reference voltage (-) = AV_{REFM} .

2.6.2 Temperature sensor/internal reference voltage characteristics

($T_A = -40$ to $+105^\circ\text{C}$, $2.7\text{ V} \leq V_{DD} \leq 5.5\text{ V}$, $V_{SS} = 0\text{ V}$, HS (high-speed main) mode)

Parameter	Symbol	Conditions	MIN.	TYP.	MAX.	Unit
Temperature sensor output voltage	V_{TMPS25}	Setting ADS register = 80H, $T_A = +25^\circ\text{C}$		1.05		V
Internal reference voltage	V_{BGRT}	Setting ADS register = 81H	1.38	1.45	1.5	V
Temperature coefficient	F_{VTMPS}	Temperature sensor that depends on the temperature		-3.6		mV/C
Operation stabilization wait time	t_{AMP}		5			μs

2.6.3 Programmable gain amplifier

($T_A = -40$ to $+105^\circ\text{C}$, $2.7\text{ V} \leq AV_{REFP} = V_{DD} \leq 5.5\text{ V}$, $V_{SS} = AV_{REFM} = 0\text{ V}$)

Parameter	Symbol	Conditions		MIN.	TYP.	MAX.	Unit
Input offset voltage	V_{IOPGA}				± 5	± 10	mV
Input voltage range	V_{IPGA}			0		$0.9V_{DD}/\text{gain}$	V
Gain error ^{Note 1}		4, 8 times				± 1	%
		16 times				± 1.5	%
		32 times				± 2	%
Slew rate ^{Note 1}	SR_{RPGA}	Rising edge	$4.0\text{ V} \leq V_{DD} \leq 5.5\text{ V}$	4, 8 times	4		V/ μs
				16, 32 times	1.4		V/ μs
		$2.7\text{ V} \leq V_{DD} < 4.0\text{ V}$	4, 8 times	1.8		V/ μs	
			16, 32 times	0.5		V/ μs	
	SR_{FPGA}	Falling edge	$4.0\text{ V} \leq V_{DD} \leq 5.5\text{ V}$	4, 8 times	3.2		V/ μs
				16, 32 times	1.4		V/ μs
		$2.7\text{ V} \leq V_{DD} < 4.0\text{ V}$	4, 8 times	1.2		V/ μs	
			16, 32 times	0.5		V/ μs	
Operation stabilization wait time ^{Note 2}	t_{PGA}	4, 8 times		5			μs
		16, 32 times		10			μs

Notes 1. When $V_{IPGA} = 0.1V_{DD}/\text{gain}$ to $0.9V_{DD}/\text{gain}$.

2. Time required until a state is entered where the DC and AC specifications of the PGA are satisfied after the PGA operation has been enabled ($PGAEN = 1$).

Remark These characteristics apply when AV_{REFM} is selected as GND of the PGA by using the CVRVS1 bit.

2.6.4 Comparator

 $(T_A = -40$ to $+105^\circ\text{C}$, $2.7\text{ V} \leq AV_{REFP} = V_{DD} \leq 5.5\text{ V}$, $V_{SS} = AV_{REFM} = 0\text{ V}$)

Parameter	Symbol	Conditions	MIN.	TYP.	MAX.	Unit
Input offset voltage	V_{IOCOMP}			± 5	± 40	mV
Input voltage range	V_{ICMP}	CMP0P to CMP5P	0		V_{DD}	V
		CMPCOM	0.045		$0.9V_{DD}$	V
Internal reference voltage deviation	ΔV_{IREF}	CmRVM register values: 7FH to 80H ($m = 0$ to 2)			± 2	LSB
		Other than above			± 1	LSB
Response time	t_{CR} , t_{CF}	Input amplitude = $\pm 100\text{ mV}$		70	150	ns
Operation stabilization wait time ^{Note 1}	t_{CMP}	$3.3\text{ V} \leq V_{DD} \leq 5.5\text{ V}$	1			μs
		$2.7\text{ V} \leq V_{DD} < 3.3\text{ V}$	3			μs
Reference voltage stabilization wait time	t_{VR}	CVRE: 0 to 1 ^{Note 2}	10			μs

- Notes**
- Time required until a state is entered where the DC and AC specifications of the comparator are satisfied after the operation of the comparator has been enabled (CMPnEN bit = 1; $n = 0$ to 5)
 - Enable comparator output (CnOE bit = 1; $n = 0$ to 5) after enabling operation of the internal reference voltage generator (by setting the CVREm bit to 1; $m = 0$ to 2) and waiting for the operation stabilization time to elapse.

Remark These characteristics apply when AV_{REFP} is selected as the power supply source of the internal reference voltage by using the CVRVS0 bit, and when AV_{REFM} is selected as GND of the internal reference voltage by using the CVRVS1 bit.

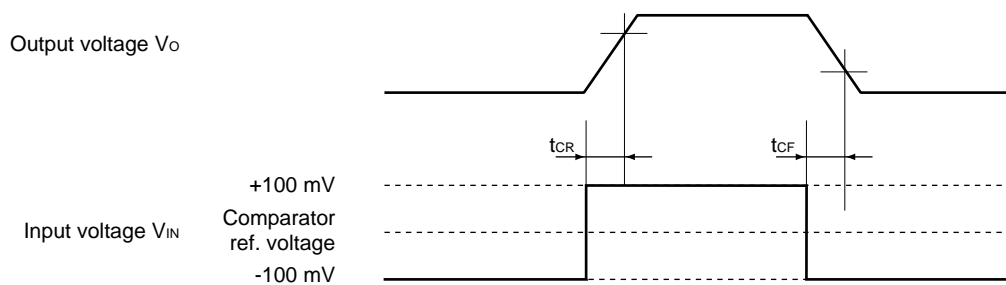

2.6.5 POR circuit characteristics

($T_A = -40$ to $+105^\circ\text{C}$, $V_{SS} = 0\text{ V}$)

Parameter	Symbol	Conditions	MIN.	TYP.	MAX.	Unit
Detection voltage	V_{POR}	Power supply rise time	1.45	1.51	1.57	V
	V_{PDR}	Power supply fall time	1.44	1.50	1.56	V
Minimum pulse width ^{Note}	T_{PW}		300			μs

Note Minimum time required for a POR reset when V_{DD} exceeds below V_{PDR} . This is also the minimum time required for a POR reset from when V_{DD} exceeds below 0.7 V to when V_{DD} exceeds V_{POR} while STOP mode is entered or the main system clock is stopped through setting bit 0 (HIOSTOP) and bit 7 (MSTOP) in the clock operation status control register (CSC).

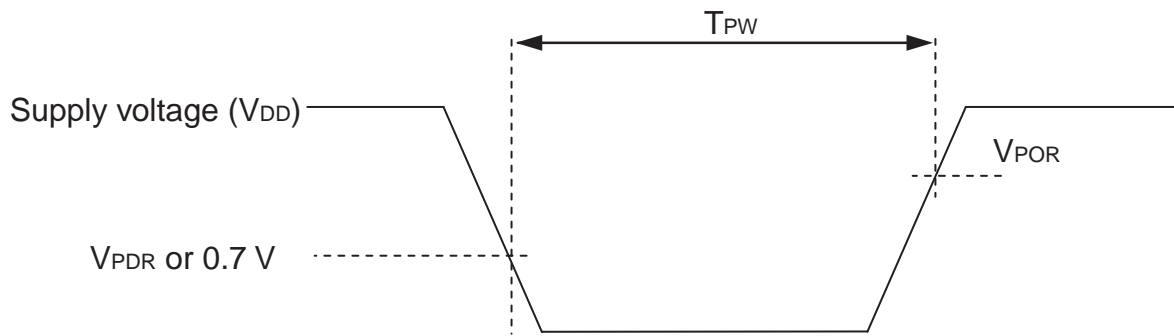

2.6.6 LVD circuit characteristics

LVD Detection Voltage of Reset Mode and Interrupt Mode**($T_A = -40$ to $+105^\circ\text{C}$, $V_{PDR} \leq V_{DD} \leq 5.5\text{ V}$, $V_{SS} = 0\text{ V}$)**

Parameter	Symbol	Conditions	MIN.	TYP.	MAX.	Unit
Detection voltage	V_{LVD0}	Power supply rise time	3.97	4.06	4.14	V
		Power supply fall time	3.89	3.98	4.06	V
	V_{LVD1}	Power supply rise time	3.67	3.75	3.82	V
		Power supply fall time	3.59	3.67	3.74	V
	V_{LVD2}	Power supply rise time	3.06	3.13	3.19	V
		Power supply fall time	2.99	3.06	3.12	V
	V_{LVD3}	Power supply rise time	2.95	3.02	3.08	V
		Power supply fall time	2.89	2.96	3.02	V
	V_{LVD4}	Power supply rise time	2.85	2.92	2.97	V
		Power supply fall time	2.79	2.86	2.91	V
	V_{LVD5}	Power supply rise time	2.75	2.81	2.87	V
		Power supply fall time	2.70	2.75	2.81	V
Minimum pulse width	t_{LW}		300			μs
Detection delay time					300	μs

LVD Detection Voltage of Interrupt & Reset Mode**($T_A = -40$ to $+105^\circ\text{C}$, $V_{PDR} \leq V_{DD} \leq 5.5\text{ V}$, $V_{SS} = 0\text{ V}$)**

Parameter	Symbol	Conditions	MIN.	TYP.	MAX.	Unit	
Interrupt and reset mode	V_{LVD0}	$V_{POC2}, V_{POC1}, V_{POC0} = 0, 1, 1$, falling reset voltage: 2.7 V	2.70	2.75	2.81	V	
	V_{LVD1}	LVIS1, LVIS0 = 1, 0	Rising release reset voltage	2.85	2.92	2.97	V
			Falling interrupt voltage	2.79	2.86	2.91	V
	V_{LVD2}	LVIS1, LVIS0 = 0, 1	Rising release reset voltage	2.95	3.02	3.08	V
			Falling interrupt voltage	2.89	2.96	3.02	V
	V_{LVD3}	LVIS1, LVIS0 = 0, 0	Rising release reset voltage	3.97	4.06	4.14	V
Falling interrupt voltage			3.89	3.98	4.06	V	

2.6.7 Supply voltage rise inclination characteristics

($T_A = -40$ to $+105^\circ\text{C}$, $V_{SS} = 0\text{ V}$)

Parameter	Symbol	Conditions	MIN.	TYP.	MAX.	Unit
Supply voltage rise	SV_{DD}				54	V/ms

Caution Keep the internal reset status by using the LVD circuit or an external reset signal until V_{DD} rises to within the operating voltage range shown in 32.4 AC Characteristics.

2.7 RAM Data Retention Characteristics

($T_A = -40$ to $+105^\circ\text{C}$, $V_{SS} = 0\text{ V}$)

Parameter	Symbol	Conditions	MIN.	TYP.	MAX.	Unit
Data retention supply voltage ^{Note 2}	V_{DDDR}		1.44 ^{Note 1}		5.5	V

Note The value depends on the POR detection voltage. When the voltage drops, the RAM data is retained before a POR reset is effected, but RAM data is not retained when a POR reset is effected.

Caution When CPU is operated at the voltage of out of the operation voltage range, RAM data is not retained. Therefore, set STOP mode before the supplied voltage is below the operation voltage range.

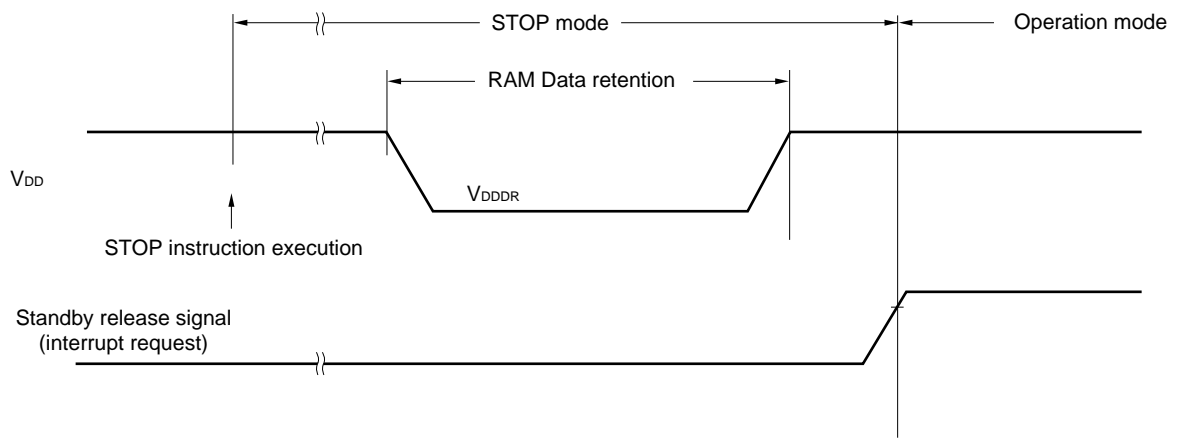

2.8 Flash Memory Programming Characteristics

($T_A = -40$ to $+105^\circ\text{C}$, $2.7\text{ V} \leq V_{DD} \leq 5.5\text{ V}$, $V_{SS} = 0\text{ V}$)

Parameter	Symbol	Conditions	MIN.	TYP.	MAX.	Unit
CPU/peripheral hardware clock frequency	f _{CLK}	$2.7\text{ V} \leq V_{DD} \leq 5.5\text{ V}$	1		32	MHz
Number of code flash rewrites ^{Notes 1, 2, 3}	C _{enwr}	Retained for 20 years, $T_A = 85^\circ\text{C}$ ^{Note 3}	1,000			Times
Number of data flash rewrites ^{Notes 1, 2, 3}		Retained for 1 year, $T_A = 25^\circ\text{C}$ ^{Note 3}		1,000,000		
		Retained for 5 years, $T_A = 85^\circ\text{C}$ ^{Note 3}	100,000			
		Retained for 20 years, $T_A = 85^\circ\text{C}$ ^{Note 3}	10,000			

Notes 1. 1 erase + 1 write after the erase is regarded as 1 rewrite. The retaining years are until next rewrite after the rewrite.

2. When using flash memory programmer and Renesas Electronics self programming library

3. These are the characteristics of the flash memory and the results obtained from reliability testing by Renesas Electronics Corporation.

2.9 Dedicated Flash Memory Programmer Communication (UART)

($T_A = -40$ to $+105^\circ\text{C}$, $2.7\text{ V} \leq V_{DD} \leq 5.5\text{ V}$, $V_{SS} = 0\text{ V}$)

Parameter	Symbol	Conditions	MIN.	TYP.	MAX.	Unit
Transfer rate		During serial programming	115.2 k		1 M	bps

2.10 Timing of Entry to Flash Memory Programming Modes

($T_A = -40$ to $+105^\circ\text{C}$, $2.7\text{ V} \leq V_{DD} \leq 5.5\text{ V}$, $V_{SS} = 0\text{ V}$)

Parameter	Symbol	Conditions	MIN.	TYP.	MAX.	Unit
How long from when an external reset ends until the initial communication settings are specified	t_{SUIINIT}	POR and LVD reset must end before the external reset ends.			100	ms
How long from when the TOOL0 pin is placed at the low level until an external reset ends	t_{SU}	POR and LVD reset must end before the external reset ends.	10			μs
How long the TOOL0 pin must be kept at the low level after a reset ends (except soft processing time)	t_{HD}	POR and LVD reset must end before the external reset ends.	1			ms

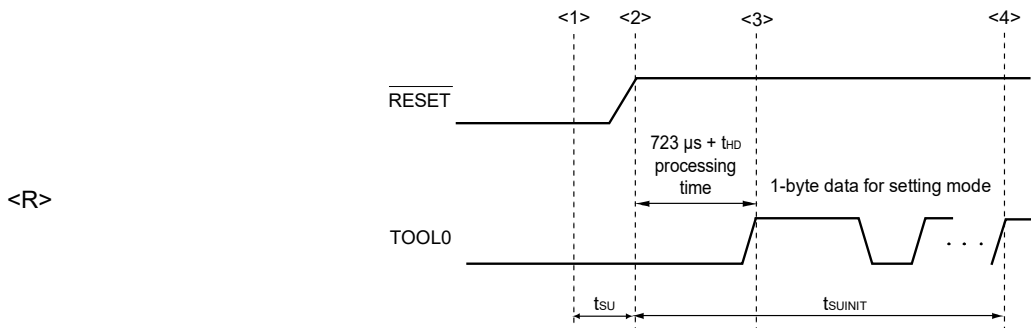

- <1> The low level is input to the TOOL0 pin.
- <2> The external reset ends (POR and LVD reset must end before the pin reset ends.).
- <3> The TOOL0 pin is set to the high level.
- <4> Complete the baud rate setting by UART reception.

Remark t_{SUIINIT} : The segment shows that it is necessary to finish specifying the initial communication settings within 100 ms from when the resets end.

t_{SU} : How long from when the TOOL0 pin is placed at the low level until an external reset ends

t_{HD} : How long to keep the TOOL0 pin at the low level from when the external and internal resets end (except soft processing time)

3. ELECTRICAL SPECIFICATIONS

(M: Industrial applications, $T_A = -40$ to $+125^\circ\text{C}$)

In this chapter, shows the electrical specifications of the target products.

Target products (M: Industrial applications): $T_A = -40$ to $+125^\circ\text{C}$
R5F107xxMxx

- Cautions**
1. The RL78/I1A has an on-chip debug function, which is provided for development and evaluation. Do not use the on-chip debug function in products designated for mass production, because the guaranteed number of rewritable times of the flash memory may be exceeded when this function is used, and product reliability therefore cannot be guaranteed. Renesas Electronics is not liable for problems occurring when the on-chip debug function is used.
 2. The pins mounted depend on the product. See 2.1 Port Function to 2.2.1 Functions for each product in the RL78/I1A User's Manual.
 3. When any of these products are used at 105°C or lower, see 2. ELECTRICAL SPECIFICATIONS ($T_A = -40$ to $+105^\circ\text{C}$).

3.1 Absolute Maximum Ratings

Absolute Maximum Ratings ($T_A = 25^\circ\text{C}$) (1/2)

Parameter	Symbols	Conditions	Ratings	Unit
Supply voltage	V_{DD}		-0.5 to +6.5	V
REGC pin input voltage	V_{REGC}	REGC	-0.3 to +2.8 and -0.3 to $V_{DD} + 0.3$ ^{Note 1}	V
Input voltage	V_{I1}	P02, P03, P05, P06, P10 to P12, P20 to P22, P24 to P27, P30, P31, P40, P75 to P77, P120 to P124, P137, P147, P200 to P206, EXCLK, EXCLKS, RESET	-0.3 to $V_{DD} + 0.3$ ^{Note 2}	V
Output voltage	V_{O1}	P02, P03, P05, P06, P10 to P12, P20 to P22, P24 to P27, P30, P31, P40, P75 to P77, P120, P147, P200 to P206	-0.3 to $V_{DD} + 0.3$ ^{Note 2}	V
Analog input voltage	V_{AI1}	ANI0 to ANI2, ANI4 to ANI7, ANI16 to ANI19	-0.3 to $V_{DD} + 0.3$ and -0.3 to $AV_{REF(+)}$ $+ 0.3$ ^{Notes 2, 3}	V

- Notes**
1. Connect the REGC pin to V_{SS} via a capacitor (0.47 to 1 μF). This value regulates the absolute maximum rating of the REGC pin. Do not use this pin with voltage applied to it.
 2. Must be 6.5 V or lower.
 3. Do not exceed $AV_{REF(+)} + 0.3$ V in case of A/D conversion target pin.

Caution Product quality may suffer if the absolute maximum rating is exceeded even momentarily for any parameter. That is, the absolute maximum ratings are rated values at which the product is on the verge of suffering physical damage, and therefore the product must be used under conditions that ensure that the absolute maximum ratings are not exceeded.

- Remarks**
1. Unless specified otherwise, the characteristics of alternate-function pins are the same as those of the port pins.
 2. $AV_{REF(+)}$: + side reference voltage of the A/D converter.
 3. V_{SS} : Reference voltage

Absolute Maximum Ratings ($T_A = 25^\circ\text{C}$) (2/2)

Parameter	Symbols	Conditions		Ratings	Unit
Output current, high	I_{OH1}	Per pin	P02, P03, P05, P06, P10 to P12, P30, P31, P40, P75 to P77, P120, P147, P200 to P206	-40	mA
		Total of all pins -170 mA	P02, P03, P40, P120	-70	mA
			P05, P06, P10 to P12, P30, P31, P75 to P77, P147, P200 to P206	-100	mA
		I_{OH2}	Per pin	P20 to P22, P24 to P27	-0.5
	Total of all pins			-2	mA
	Output current, low	I_{OL1}	Per pin	P02, P03, P05, P06, P10 to P12, P30, P31, P40, P75 to P77, P120, P147, P200 to P206	40
Total of all pins 170 mA			P02, P03, P40, P120	70	mA
			P05, P06, P10 to P12, P30, P31, P75 to P77, P147, P200 to P206	100	mA
I_{OL2}			Per pin	P20 to P22, P24 to P27	1
		Total of all pins		5	mA
Operating ambient temperature		T_A	In normal operation mode		-40 to +125
	In flash memory programming mode		-40 to +105		
Storage temperature	T_{stg}			-65 to +150	$^\circ\text{C}$

Caution Product quality may suffer if the absolute maximum rating is exceeded even momentarily for any parameter. That is, the absolute maximum ratings are rated values at which the product is on the verge of suffering physical damage, and therefore the product must be used under conditions that ensure that the absolute maximum ratings are not exceeded.

Remark Unless specified otherwise, the characteristics of alternate-function pins are the same as those of the port pins.

3.2 Oscillator Characteristics

3.2.1 X1, XT1 oscillator characteristics

($T_A = -40$ to $+125^\circ\text{C}$, $2.7\text{ V} \leq V_{DD} \leq 5.5\text{ V}$, $V_{SS} = 0\text{ V}$)

Parameter	Resonator	Conditions	MIN.	TYP.	MAX.	Unit
X1 clock frequency (f_x) ^{Note}	Ceramic resonator/ crystal resonator		1.0		20.0	MHz
XT1 clock frequency (f_{XT}) ^{Note}	Crystal resonator		32	32.768	35	kHz

Note Indicates only permissible oscillator frequency ranges. See **AC Characteristics** for instruction execution time. Request evaluation by the manufacturer of the oscillator circuit mounted on a board to check the oscillator characteristics.

Caution Since the CPU is started by the high-speed on-chip oscillator clock after a reset release, check the X1 clock oscillation stabilization time using the oscillation stabilization time counter status register (OSTC) by the user. Determine the oscillation stabilization time of the OSTC register and the oscillation stabilization time select register (OSTS) after sufficiently evaluating the oscillation stabilization time with the resonator to be used.

Remark When using the X1 oscillator and XT1 oscillator, see 5.4 System Clock Oscillator in the RL78/I1A User's Manual.

3.2.2 On-chip oscillator characteristics

($T_A = -40$ to $+125^\circ\text{C}$, $2.7\text{ V} \leq V_{DD} \leq 5.5\text{ V}$, $V_{SS} = 0\text{ V}$)

Oscillators	Parameters	Conditions	MIN.	TYP.	MAX.	Unit
High-speed on-chip oscillator clock frequency ^{Note 1}	f_{IH}		1		32	MHz
High-speed on-chip oscillator clock frequency accuracy ^{Note 2}		$T_A = -20$ to 85°C	-1		+1	%
		$T_A = -40$ to 105°C	-1.5		+1.5	%
		$T_A = -40$ to 125°C When 16 MHz selected	-2		+2	%
Low-speed on-chip oscillator clock frequency	f_{IL}			15		kHz
Low-speed on-chip oscillator clock frequency accuracy			-15		+15	%

Notes 1. Frequency can be selected in a high-speed on-chip oscillator. Selected by bits 0 to 3 of option byte (000C2H/010C2H).

2. This indicates the oscillator characteristics only. See **AC Characteristics** for instruction execution time.

Remark When using the device at an ambient temperature that exceeds $T_A = 105^\circ\text{C}$, the selectable oscillation frequency is 16 MHz max.

3.2.3 PLL characteristics

($T_A = -40$ to $+125^\circ\text{C}$, $2.7\text{ V} \leq V_{DD} \leq 5.5\text{ V}$, $V_{SS} = 0\text{ V}$)

Parameter	Symbol	Conditions	MIN.	TYP.	MAX.	Unit
PLL input clock frequency ^{Note}	f_{PLLIN}	High-speed system clock is selected ($f_{MX} = 4\text{ MHz}$)	3.92	4.00	4.08	MHz
		High-speed on-chip oscillator clock is selected ($f_{IH} = 4\text{ MHz}$)	3.92	4.00	4.08	MHz
PLL output clock frequency ^{Note}	f_{PLL}		$f_{PLLIN} \times 16$			MHz

Note This only indicates the oscillator characteristics. See **AC Characteristics** for instruction execution time.

Remark When using the device at an ambient temperature that exceeds $T_A = 105^\circ\text{C}$, only 16 MHz ($f_{PLL} \times 1/4$) can be selected as the CPU operating frequency.

3.3 DC Characteristics

3.3.1 Pin characteristics

($T_A = -40$ to $+125^\circ\text{C}$, $2.7\text{ V} \leq V_{DD} \leq 5.5\text{ V}$, $V_{SS} = 0\text{ V}$)

Items	Symbol	Conditions	MIN.	TYP.	MAX.	Unit	
Output current, high ^{Note 1}	I _{OH1}	Per pin for P02, P03, P05, P06, P10 to P12, P30, P31, P40, P75 to P77, P120, P147, P200 to P206	$4.0\text{ V} \leq V_{DD} \leq 5.5\text{ V}$			-3.0 ^{Note 2}	mA
			$2.7\text{ V} \leq V_{DD} < 4.0\text{ V}$			-1.0	mA
		Total of P02, P03, P40, P120 (When duty $\leq 70\%$ ^{Note 3})	$4.0\text{ V} \leq V_{DD} \leq 5.5\text{ V}$			-9.0	mA
			$2.7\text{ V} \leq V_{DD} < 4.0\text{ V}$			-3.0	mA
		Total of P05, P06, P10 to P12, P30, P31, P75 to P77, P147, P200 to P206 (When duty $\leq 70\%$ ^{Note 3})	$4.0\text{ V} \leq V_{DD} \leq 5.5\text{ V}$			-21.0	mA
			$2.7\text{ V} \leq V_{DD} < 4.0\text{ V}$			-6.0	mA
	Total of all pins (When duty $\leq 70\%$ ^{Note 3})	$4.0\text{ V} \leq V_{DD} \leq 5.5\text{ V}$			-21.0	mA	
		$2.7\text{ V} \leq V_{DD} < 4.0\text{ V}$			-9.0	mA	
I _{OH2}	Per pin for P20 to P22, P24 to P27	$2.7\text{ V} \leq V_{DD} \leq 5.5\text{ V}$			-0.1 ^{Note 2}	mA	
		Total of all pins (When duty $\leq 70\%$ ^{Note 3})	$2.7\text{ V} \leq V_{DD} \leq 5.5\text{ V}$			-0.4	mA

Notes 1. Value of current at which the device operation is guaranteed even if the current flows from the V_{DD} pin to an output pin.

2. However, do not exceed the total current value.

3. Specification under conditions where the duty factor $\leq 70\%$.

The output current value that has changed to the duty factor $> 70\%$ the duty ratio can be calculated with the following expression (when changing the duty factor from 70% to n%).

- Total output current of pins = $(I_{OH} \times 0.7)/(n \times 0.01)$

<Example> Where $n = 80\%$ and $I_{OH} = -10.0\text{ mA}$

$$\text{Total output current of pins} = (-10.0 \times 0.7)/(80 \times 0.01) \cong -8.7\text{ mA}$$

However, the current that is allowed to flow into one pin does not vary depending on the duty factor.

A current higher than the absolute maximum rating must not flow into one pin.

Caution P02, P10 to P12 do not output high level in N-ch open-drain mode.

Remark Unless specified otherwise, the characteristics of alternate-function pins are the same as those of the port pins.

($T_A = -40$ to $+125^\circ\text{C}$, $2.7\text{ V} \leq V_{DD} \leq 5.5\text{ V}$, $V_{SS} = 0\text{ V}$)

Items	Symbol	Conditions	MIN.	TYP.	MAX.	Unit	
Output current, I_{OL} ^{Note 1}	I _{OL1}	Per pin for P02, P03, P05, P06, P10 to P12, P30, P31, P40, P75 to P77, P120, P147, P200 to P206	$4.0\text{ V} \leq V_{DD} \leq 5.5\text{ V}$			8.5 ^{Note 2}	mA
			$2.7\text{ V} \leq V_{DD} < 4.0\text{ V}$			1.5 ^{Note 2}	mA
		Total of P02, P03, P40, P120 (When duty $\leq 70\%$ ^{Note 3})	$4.0\text{ V} \leq V_{DD} \leq 5.5\text{ V}$			20.0	mA
			$2.7\text{ V} \leq V_{DD} < 4.0\text{ V}$			5.0	mA
		Total of P05, P06, P10 to P12, P30, P31, P75 to P77, P147, P200 to P206 (When duty $\leq 70\%$ ^{Note 3})	$4.0\text{ V} \leq V_{DD} \leq 5.5\text{ V}$			20.0	mA
			$2.7\text{ V} \leq V_{DD} < 4.0\text{ V}$			10.0	mA
	Total of all pins (When duty $\leq 70\%$ ^{Note 3})	$4.0\text{ V} \leq V_{DD} \leq 5.5\text{ V}$			40.0	mA	
		$2.7\text{ V} \leq V_{DD} < 4.0\text{ V}$			15.0	mA	
	I _{OL2}	Per pin for P20 to P22, P24 to P27	$2.7\text{ V} \leq V_{DD} \leq 5.5\text{ V}$			0.4 ^{Note 2}	mA
			Total of all pins (When duty $\leq 70\%$ ^{Note 3})	$2.7\text{ V} \leq V_{DD} \leq 5.5\text{ V}$			1.6

- Notes**
- Value of current at which the device operation is guaranteed even if the current flows from an output pin to the V_{SS} pin.
 - However, do not exceed the total current value.
 - Specification under conditions where the duty factor $\leq 70\%$.
The output current value that has changed to the duty factor $> 70\%$ the duty ratio can be calculated with the following expression (when changing the duty factor from 70% to n%).
 - Total output current of pins = $(I_{OL} \times 0.7)/(n \times 0.01)$
<Example> Where $n = 80\%$ and $I_{OL} = -10.0\text{ mA}$
Total output current of pins = $(-10.0 \times 0.7)/(80 \times 0.01) \cong -8.7\text{ mA}$
 However, the current that is allowed to flow into one pin does not vary depending on the duty factor. A current higher than the absolute maximum rating must not flow into one pin.

Remark Unless specified otherwise, the characteristics of alternate-function pins are the same as those of the port pins.

($T_A = -40$ to $+125^\circ\text{C}$, $2.7\text{ V} \leq V_{DD} \leq 5.5\text{ V}$, $V_{SS} = 0\text{ V}$)

Items	Symbol	Conditions	MIN.	TYP.	MAX.	Unit		
Input voltage, high	V_{IH1}	P02, P03, P05, P06, P10 to P12, P20 to P22, P24 to P27, P30, P31, P40, P75 to P77, P120 to P124, P137, P147, P200 to P206, EXCLK, EXCLKS, $\overline{\text{RESET}}$	Normal input buffer	$0.8V_{DD}$		V_{DD}	V	
			TTL input buffer $4.0\text{ V} \leq V_{DD} \leq 5.5\text{ V}$	2.1		V_{DD}	V	
				TTL input buffer $3.3\text{ V} \leq V_{DD} < 4.0\text{ V}$	2.0		V_{DD}	V
				TTL input buffer $2.7\text{ V} \leq V_{DD} < 3.3\text{ V}$	1.5		V_{DD}	V
Input voltage, low	V_{IL1}	P02, P03, P05, P06, P10 to P12, P20 to P22, P24 to P27, P30, P31, P40, P75 to P77, P120 to P124, P137, P147, P200 to P206, EXCLK, EXCLKS, $\overline{\text{RESET}}$	Normal input buffer	0		$0.2V_{DD}$	V	
			TTL input buffer $4.0\text{ V} \leq V_{DD} \leq 5.5\text{ V}$	0		0.8	V	
				TTL input buffer $3.3\text{ V} \leq V_{DD} < 4.0\text{ V}$	0		0.5	V
				TTL input buffer $2.7\text{ V} \leq V_{DD} < 3.3\text{ V}$	0		0.32	V
	V_{IL2}	P03, P10, P11	TTL input buffer $4.0\text{ V} \leq V_{DD} \leq 5.5\text{ V}$	0		0.8	V	
			TTL input buffer $3.3\text{ V} \leq V_{DD} < 4.0\text{ V}$	0		0.5	V	
			TTL input buffer $2.7\text{ V} \leq V_{DD} < 3.3\text{ V}$	0		0.32	V	

Caution The maximum value of V_{IH} of pins P02, P10 to P12 is V_{DD} , even in the N-ch open-drain mode.

Remark Unless specified otherwise, the characteristics of alternate-function pins are the same as those of the port pins.

($T_A = -40$ to $+125^\circ\text{C}$, $2.7\text{ V} \leq V_{DD} \leq 5.5\text{ V}$, $V_{SS} = 0\text{ V}$)

Items	Symbol	Conditions	MIN.	TYP.	MAX.	Unit
Output voltage, high	V _{OH1}	P02, P03, P05, P06, P10 to P12, P30, P31, P40, P75 to P77, P120, P147, P200 to P206	$4.0\text{ V} \leq V_{DD} \leq 5.5\text{ V}$, $I_{OH1} = -3.0\text{ mA}$		$V_{DD} - 0.7$	V
			$2.7\text{ V} \leq V_{DD} \leq 5.5\text{ V}$, $I_{OH1} = -1.0\text{ mA}$		$V_{DD} - 0.5$	V
	V _{OH2}	P20 to P22, P24 to P27	$2.7\text{ V} \leq V_{DD} \leq 5.5\text{ V}$, $I_{OH2} = -100\ \mu\text{A}$		$V_{DD} - 0.5$	V
Output voltage, low	V _{OL1}	P02, P03, P05, P06, P10 to P12, P30, P31, P40, P75 to P77, P120, P147, P200 to P206	$4.0\text{ V} \leq V_{DD} \leq 5.5\text{ V}$, $I_{OL1} = 8.5\text{ mA}$		0.7	V
			$4.0\text{ V} \leq V_{DD} \leq 5.5\text{ V}$, $I_{OL1} = 4.0\text{ mA}$		0.4	V
			$2.7\text{ V} \leq V_{DD} \leq 5.5\text{ V}$, $I_{OL1} = 1.5\text{ mA}$		0.4	V
	V _{OL2}	P20 to P22, P24 to P27	$2.7\text{ V} \leq V_{DD} \leq 5.5\text{ V}$, $I_{OL2} = 400\ \mu\text{A}$		0.4	V

Caution P02, P10 to P12 do not output high level in N-ch open-drain mode.

Remark Unless specified otherwise, the characteristics of alternate-function pins are the same as those of the port pins.

($T_A = -40$ to $+125^\circ\text{C}$, $2.7\text{ V} \leq V_{DD} \leq 5.5\text{ V}$, $V_{SS} = 0\text{ V}$)

Items	Symbol	Conditions	MIN.	TYP.	MAX.	Unit		
Input leakage current, high	I_{LIH1}	P02, P03, P05, P06, P10 to P12, P20 to P22, P24 to P27, P30, P31, P40, P75 to P77, P120, P137, P147, P200 to P206, RESET	$V_i = V_{DD}$			1	μA	
	I_{LIH2}	P121 to P124 (X1, X2, XT1, XT2, EXCLK, EXCLKS)	$V_i = V_{DD}$	In input port or external clock input			1	μA
				In resonator connection			10	μA
Input leakage current, low	I_{LIL1}	P02, P03, P05, P06, P10 to P12, P20 to P22, P24 to P27, P30, P31, P40, P75 to P77, P120, P137, P147, P200 to P206, RESET	$V_i = V_{SS}$			-1	μA	
	I_{LIL2}	P121 to P124 (X1, X2, XT1, XT2, EXCLK, EXCLKS)	$V_i = V_{SS}$	In input port or external clock input			-1	μA
				In resonator connection			-10	μA
On-chip pull-up resistance	R_U	P02, P03, P05, P06, P10 to P12, P30, P31, P40, P75 to P77, P120, P147, P200 to P206	$V_i = V_{SS}$, In input port	10	20	100	$\text{k}\Omega$	

Remark Unless specified otherwise, the characteristics of alternate-function pins are the same as those of the port pins.

3.3.2 Supply current characteristics

 $(T_A = -40$ to $+125^\circ\text{C}$, $2.7\text{ V} \leq V_{DD} \leq 5.5\text{ V}$, $V_{SS} = 0\text{ V}$) (1/2)

Parameter	Symbol	Conditions				MIN.	TYP.	MAX.	Unit
Supply current Note 1	I _{DD1}	Operating mode	HS (high-speed main) mode ^{Note 5}	f _{IH} = 16 MHz ^{Note 3}	V _{DD} = 5.0 V		2.9	4.8	mA
					V _{DD} = 3.0 V		2.9	4.8	mA
		HS (high-speed main) mode ^{Note 5}	f _{MX} = 20 MHz ^{Note 2} , V _{DD} = 5.0 V	Square wave input		3.2	5.6	mA	
				Resonator connection		3.3	5.7	mA	
			f _{MX} = 20 MHz ^{Note 2} , V _{DD} = 3.0 V	Square wave input		3.2	5.6	mA	
				Resonator connection		3.3	5.7	mA	
			f _{MX} = 10 MHz ^{Note 2} , V _{DD} = 5.0 V	Square wave input		2.0	3.3	mA	
				Resonator connection		2.0	3.3	mA	
			f _{MX} = 10 MHz ^{Note 2} , V _{DD} = 3.0 V	Square wave input		2.0	3.3	mA	
				Resonator connection		2.0	3.3	mA	
		HS (high-speed main) mode ^{Note 5}	f _{IH} = 4 MHz ^{Note 3} f _{PLL} = 64 MHz, f _{CLK} = 16 MHz	V _{DD} = 5.0 V		3.3	6.5	mA	
				V _{DD} = 3.0 V		3.3	6.5	mA	
		Subsystem clock operation	f _{SUB} = 32.768 kHz ^{Note 4} T _A = -40°C	Square wave input		4.2	6.0	μA	
				Resonator connection		4.4	6.2	μA	
			f _{SUB} = 32.768 kHz ^{Note 4} T _A = +25°C	Square wave input		4.2	6.0	μA	
				Resonator connection		4.4	6.2	μA	
			f _{SUB} = 32.768 kHz ^{Note 4} T _A = +50°C	Square wave input		4.3	7.2	μA	
				Resonator connection		4.5	7.4	μA	
			f _{SUB} = 32.768 kHz ^{Note 4} T _A = +70°C	Square wave input		4.4	8.1	μA	
				Resonator connection		4.6	8.3	μA	
f _{SUB} = 32.768 kHz ^{Note 4} T _A = +85°C	Square wave input			5.2	11.4	μA			
	Resonator connection			5.4	11.6	μA			
f _{SUB} = 32.768 kHz ^{Note 4} T _A = +105°C	Square wave input			6.9	20.8	μA			
	Resonator connection			7.1	21.0	μA			
f _{SUB} = 32.768 kHz ^{Note 4} T _A = +125°C	Square wave input		11.1	51.2	μA				
	Resonator connection		11.3	51.4	μA				

(Notes and Remarks are listed on the next page.)

- Notes**
1. Total current flowing into V_{DD} , including the input leakage current flowing when the level of the input pin is fixed to V_{DD} or V_{SS} . The values below the MAX. column include the peripheral operation current. However, not including the current flowing into the A/D converter, comparator, programmable gain amplifier, LVD circuit, I/O port, and on-chip pull-up/pull-down resistors and the current flowing during data flash rewrite.
 2. When high-speed on-chip oscillator and subsystem clock are stopped.
 3. When high-speed system clock and subsystem clock are stopped.
 4. When high-speed on-chip oscillator and high-speed system clock are stopped. When AMPHS1 = 1 (Ultra-low power consumption oscillation). However, not including the current flowing into the RTC, 12-bit interval timer, and watchdog timer.
 5. Relationship between operation voltage width, operation frequency of CPU and operation mode is as below.
HS (high-speed main) mode: $2.7\text{ V} \leq V_{DD} \leq 5.5\text{ V}@1\text{ MHz to }20\text{ MHz}$

- Remarks**
1. f_{MX} : High-speed system clock frequency (X1 clock oscillation frequency or external main system clock frequency)
 2. f_{IH} : High-speed on-chip oscillator clock frequency
 3. f_{SUB} : Subsystem clock frequency (XT1 clock oscillation frequency)
 4. Except subsystem clock operation, temperature condition of the TYP. value is $T_A = 25^\circ\text{C}$

$(T_A = -40$ to $+125^\circ\text{C}$, $2.7\text{ V} \leq V_{DD} \leq 5.5\text{ V}$, $V_{SS} = 0\text{ V}$) (2/2)

Parameter	Symbol	Conditions			MIN.	TYP.	MAX.	Unit	
Supply current Note 1	I_{DD2} Note 2	HALT mode	HS (high-speed main) mode Note 7	$f_{IH} = 16\text{ MHz}$ Note 4	$V_{DD} = 5.0\text{ V}$		0.50	2.0	mA
					$V_{DD} = 3.0\text{ V}$		0.50	2.0	mA
			HS (high-speed main) mode Note 7	$f_{MX} = 20\text{ MHz}$ Note 3, $V_{DD} = 5.0\text{ V}$	Square wave input		0.40	2.2	mA
					Resonator connection		0.50	2.3	mA
				$f_{MX} = 20\text{ MHz}$ Note 3, $V_{DD} = 3.0\text{ V}$	Square wave input		0.40	2.2	mA
					Resonator connection		0.50	2.3	mA
				$f_{MX} = 10\text{ MHz}$ Note 3, $V_{DD} = 5.0\text{ V}$	Square wave input		0.24	1.22	mA
					Resonator connection		0.30	1.28	mA
			$f_{MX} = 10\text{ MHz}$ Note 3, $V_{DD} = 3.0\text{ V}$	Square wave input		0.24	1.22	mA	
				Resonator connection		0.30	1.28	mA	
			HS (high-speed main) mode Note 7	$f_{IH} = 4\text{ MHz}$ Note 4 $f_{PLL} = 64\text{ MHz}$, $f_{CLK} = 16\text{ MHz}$	$V_{DD} = 5.0\text{ V}$		0.95	3.7	mA
					$V_{DD} = 3.0\text{ V}$		0.95	3.7	mA
			Subsystem clock operation	$f_{SUB} = 32.768\text{ kHz}$ Note 5 $T_A = -40^\circ\text{C}$	Square wave input		0.28	0.70	μA
					Resonator connection		0.47	0.89	μA
				$f_{SUB} = 32.768\text{ kHz}$ Note 5 $T_A = +25^\circ\text{C}$	Square wave input		0.33	0.70	μA
					Resonator connection		0.52	0.89	μA
				$f_{SUB} = 32.768\text{ kHz}$ Note 5 $T_A = +50^\circ\text{C}$	Square wave input		0.41	1.90	μA
					Resonator connection		0.60	2.09	μA
				$f_{SUB} = 32.768\text{ kHz}$ Note 5 $T_A = +70^\circ\text{C}$	Square wave input		0.54	2.80	μA
	Resonator connection				0.73	2.99	μA		
	$f_{SUB} = 32.768\text{ kHz}$ Note 5 $T_A = +85^\circ\text{C}$	Square wave input			1.27	6.10	μA		
		Resonator connection			1.46	6.29	μA		
	$f_{SUB} = 32.768\text{ kHz}$ Note 5 $T_A = +105^\circ\text{C}$	Square wave input		3.04	15.5	μA			
Resonator connection			3.23	15.7	μA				
$f_{SUB} = 32.768\text{ kHz}$ Note 5 $T_A = +125^\circ\text{C}$	Square wave input		7.20	45.2	μA				
	Resonator connection		7.53	45.5	μA				
I_{DD3} Note 6	STOP mode Note 8	$T_A = -40^\circ\text{C}$				0.18	0.50	μA	
		$T_A = +25^\circ\text{C}$				0.23	0.50	μA	
		$T_A = +50^\circ\text{C}$				0.27	1.70	μA	
		$T_A = +70^\circ\text{C}$				0.44	2.60	μA	
		$T_A = +85^\circ\text{C}$				1.17	5.90	μA	
		$T_A = +105^\circ\text{C}$				2.94	15.3	μA	
		$T_A = +125^\circ\text{C}$				7.14	45.1	μA	

(Notes and Remarks are listed on the next page.)

- Notes**
1. Total current flowing into V_{DD} , including the input leakage current flowing when the level of the input pin is fixed to V_{DD} or V_{SS} . The values below the MAX. column include the peripheral operation current. However, not including the current flowing into the A/D converter, comparator, programmable gain amplifier, LVD circuit, I/O port, and on-chip pull-up/pull-down resistors and the current flowing during data flash rewrite.
 2. During HALT instruction execution by flash memory.
 3. When high-speed on-chip oscillator and subsystem clock are stopped.
 4. When high-speed system clock and subsystem clock are stopped.
 5. When high-speed on-chip oscillator and high-speed system clock are stopped. When $RTCLPC = 1$ and setting ultra-low current consumption ($AMPHS1 = 1$). The current flowing into the RTC is included. However, not including the current flowing into the 12-bit interval timer and watchdog timer.
 6. Not including the current flowing into the RTC, 12-bit interval timer, and watchdog timer.
 7. Relationship between operation voltage width, operation frequency of CPU and operation mode is as below.
HS (high-speed main) mode: $2.7\text{ V} \leq V_{DD} \leq 5.5\text{ V}@1\text{ MHz to }20\text{ MHz}$
 8. Regarding the value for current operate the subsystem clock in STOP mode, refer to that in HALT mode.

- Remarks**
1. f_{MX} : High-speed system clock frequency (X1 clock oscillation frequency or external main system clock frequency)
 2. f_{IH} : High-speed on-chip oscillator clock frequency
 3. f_{SUB} : Subsystem clock frequency (XT1 clock oscillation frequency)
 4. Except subsystem clock operation and STOP mode, temperature condition of the TYP. value is $T_A = 25^\circ\text{C}$

$(T_A = -40$ to $+125^\circ\text{C}$, $2.7\text{ V} \leq V_{DD} \leq 5.5\text{ V}$, $V_{SS} = 0\text{ V}$)

Parameter	Symbol	Conditions		MIN.	TYP.	MAX.	Unit
Low-speed on-chip oscillator operating current	I_{FIL} ^{Note 1}				0.20		μA
RTC operating current	I_{RTC} Notes 1, 2, 3				0.02		μA
12-bit interval timer operating current	I_{IT} Notes 1, 2, 4				0.02		μA
Watchdog timer operating current	I_{WDT} Notes 1, 2, 5	$f_{IL} = 15\text{ kHz}$			0.22		μA
A/D converter operating current	I_{ADC} Notes 1, 6	When conversion at maximum speed	Normal mode, $AV_{REFP} = V_{DD} = 5.0\text{ V}$		1.3	1.7	mA
A/D converter reference voltage current	I_{ADREF} ^{Note 1}				75.0		μA
Temperature sensor operating current	I_{TMPS} ^{Note 1}				75.0		μA
LVD operating current	I_{LVD} Notes 1, 7				0.08		μA
Self-programming operating current	I_{FSP} Notes 1, 8				2.5	12.2	mA
Programmable gain amplifier operating current	I_{PGA} ^{Note 9}			$AV_{REFP} = V_{DD} = 5.0\text{ V}$	0.21	0.37	mA
				$AV_{REFP} = V_{DD} = 3.0\text{ V}$	0.18	0.35	mA
Comparator operating current	I_{CMP} ^{Note 10}	When one comparator channel is operating		$AV_{REFP} = V_{DD} = 5.0\text{ V}$	41.4	74	μA
				$AV_{REFP} = V_{DD} = 3.0\text{ V}$	37.2	71	μA
	I_{VREF}	When one internal reference voltage circuit is operating		$AV_{REFP} = V_{DD} = 5.0\text{ V}$	14.8	31	μA
				$AV_{REFP} = V_{DD} = 3.0\text{ V}$	8.9	24	μA
Programmable gain amplifier/comparator reference current source	I_{IREF} ^{Note 11}			$AV_{REFP} = V_{DD} = 5.0\text{ V}$	3.2	6.1	μA
				$AV_{REFP} = V_{DD} = 3.0\text{ V}$	2.9	4.9	μA
BGO operating current	I_{BGO} ^{Note 12}				2.50	12.2	mA
SNOOZE operating current	I_{SNOZ} ^{Note 1}	A/D converter operation	The mode is performed ^{Note 13}		0.50	1.10	mA
			The A/D conversion operations are performed, Normal mode, $AV_{REFP} = V_{DD} = 5.0\text{ V}$		1.20	2.17	mA
		CSI/UART operation			0.70	1.27	mA

(Notes and Remarks are listed on the next page.)

- Notes**
1. Current flowing to the V_{DD} .
 2. When the high-speed on-chip oscillator and high-speed system clock are stopped.
 3. Current flowing only to the real-time clock (RTC) (excluding the operating current of the low-speed on-chip oscillator and the XT1 oscillator). The supply current of the RL78 microcontrollers is the sum of the values of either I_{DD1} or I_{DD2} , and I_{RTC} , when the real-time clock is operating in operating mode or in HALT mode. When the low-speed on-chip oscillator is selected, I_{FIL} should be added. I_{DD2} subsystem clock operation includes the operational current of the real-time clock.
 4. Current flowing only to the 12-bit interval timer (excluding the operating current of the XT1 oscillator and I_{FIL} operating current). The current of the RL78 microcontrollers is the sum of the values of either I_{DD1} or I_{DD2} , and I_{IT} , when the 12-bit interval timer operates in operation mode or HALT mode. When the low-speed on-chip oscillator is selected, I_{FIL} should be added.
 5. Current flowing only to the watchdog timer (including the operating current of the low-speed on-chip oscillator). The supply current value of the RL78 microcontrollers is the sum of I_{DD1} , I_{DD2} or I_{DD3} , and I_{WDT} , when the watchdog timer is operating.
 6. Current flowing only to the A/D converter. The supply current value of the RL78 microcontrollers is the sum of I_{DD1} or I_{DD2} and I_{ADC} , when the A/D converter is operating in operating mode or in HALT mode.
 7. Current flowing only to the LVD circuit. The supply current of the RL78 microcontrollers is the sum of I_{DD1} , I_{DD2} or I_{DD3} and I_{LVD} when the LVD circuit is in operation.
 8. Current flowing during self-programming operation.
 9. Current flowing only to the programmable gain amplifier. The supply current value of the RL78 microcontrollers is the sum of I_{DD1} , I_{DD2} or I_{DD3} , and I_{PGA} , when the programmable gain amplifier is operating in operating mode or in HALT mode.
 10. Current flowing only to the comparator. The supply current value of the RL78 microcontrollers is the sum of I_{DD1} , I_{DD2} or I_{DD3} , and I_{CMP} , when the comparator is operating.
 11. This is the current required to flow to V_{DD} pin of the current circuit that is used as the programmable gain amplifier and the comparator.
 12. Current flowing only during data flash rewrite.
 13. See **21.3.3 SNOOZE mode in the RL78/I1A User's Manual** for shift time to the SNOOZE mode.

- Remarks**
1. f_{IL} : Low-speed on-chip oscillator clock frequency
 2. f_{SUB} : Subsystem clock frequency (XT1 clock oscillation frequency)
 3. f_{CLK} : CPU/peripheral hardware clock frequency
 4. Temperature condition of the TYP. value is $T_A = 25^\circ\text{C}$
 5. Example of calculating current value when using programmable gain amplifier and comparator.
Examples 1) TYP. operating current value when three comparator channels, one internal reference voltage generator, and PGA are operating (when $AV_{REFP} = V_{DD} = 5.0\text{ V}$)

$$\begin{aligned}
 & I_{CMP} \times 3 + I_{VREF} + I_{PGA} + I_{IREF} \\
 &= 41.4 [\mu\text{A}] \times 3 + 14.8 [\mu\text{A}] \times 1 + 210 [\mu\text{A}] + 3.2 [\mu\text{A}] \\
 &= 352.2 [\mu\text{A}]
 \end{aligned}$$

- Examples 2) TYP. operating current value when using two comparator channels, without using internal reference voltage generator (when $AV_{REFP} = V_{DD} = 5.0\text{ V}$)

$$\begin{aligned}
 & I_{CMP} \times 2 + I_{IREF} \\
 &= 41.4 [\mu\text{A}] \times 2 + 3.2 [\mu\text{A}] \\
 &= 86.0 [\mu\text{A}]
 \end{aligned}$$

3.4 AC Characteristics

 $(T_A = -40$ to $+125^\circ\text{C}$, $2.7\text{ V} \leq V_{DD} \leq 5.5\text{ V}$, $V_{SS} = 0\text{ V})$

Items	Symbol	Conditions		MIN.	TYP.	MAX.	Unit
Instruction cycle (minimum instruction execution time)	T_{CY}	Main system clock (f_{MAIN}) operation	HS (high-speed main) mode	0.05		1	μs
		Subsystem clock (f_{SUB}) operation		28.5	30.5	31.3	μs
		In the self programming mode	HS (high-speed main) mode	$T_A = -40$ to $+105^\circ\text{C}$	0.05		1
External system clock frequency	f_{EX}			1.0		20.0	MHz
	f_{EXS}			32		35	kHz
External system clock input high-level width, low-level width	t_{EXH} , t_{EXL}			24			ns
	t_{EXHS} , t_{EXLS}			13.7			μs
TI03, TI05, TI06, TI07 input high-level width, low-level width	t_{TIH} , t_{TIL}			$2/f_{MCK}+10$			ns
TO03, TO05, TO06, TKBO00, TKBO01, TKBO10, TKBO11, TKBO20, TKBO21, TKCO00 to TKCO05 output frequency (When duty = 50%)	f_{TO}	HS (high-speed main) mode	$4.0\text{ V} \leq V_{DD} \leq 5.5\text{ V}$			5	MHz
			$2.7\text{ V} \leq V_{DD} < 4.0\text{ V}$			4	MHz
Interrupt input high-level width, low-level width	t_{INTH} , t_{INTL}	INTP0, INTP3, INTP4, INTP9 to INTP11, INTP20 to INTP23	$2.7\text{ V} \leq V_{DD} \leq 5.5\text{ V}$	1			μs
RESET low-level width	t_{RSL}			10			μs

Remark f_{MCK} : Timer array unit operation clock frequency

(Operation clock to be set by the CKS0n bit of timer mode register 0n (TMR0n). n: Channel number (n = 0 to 7))

Minimum Instruction Execution Time during Main System Clock Operation

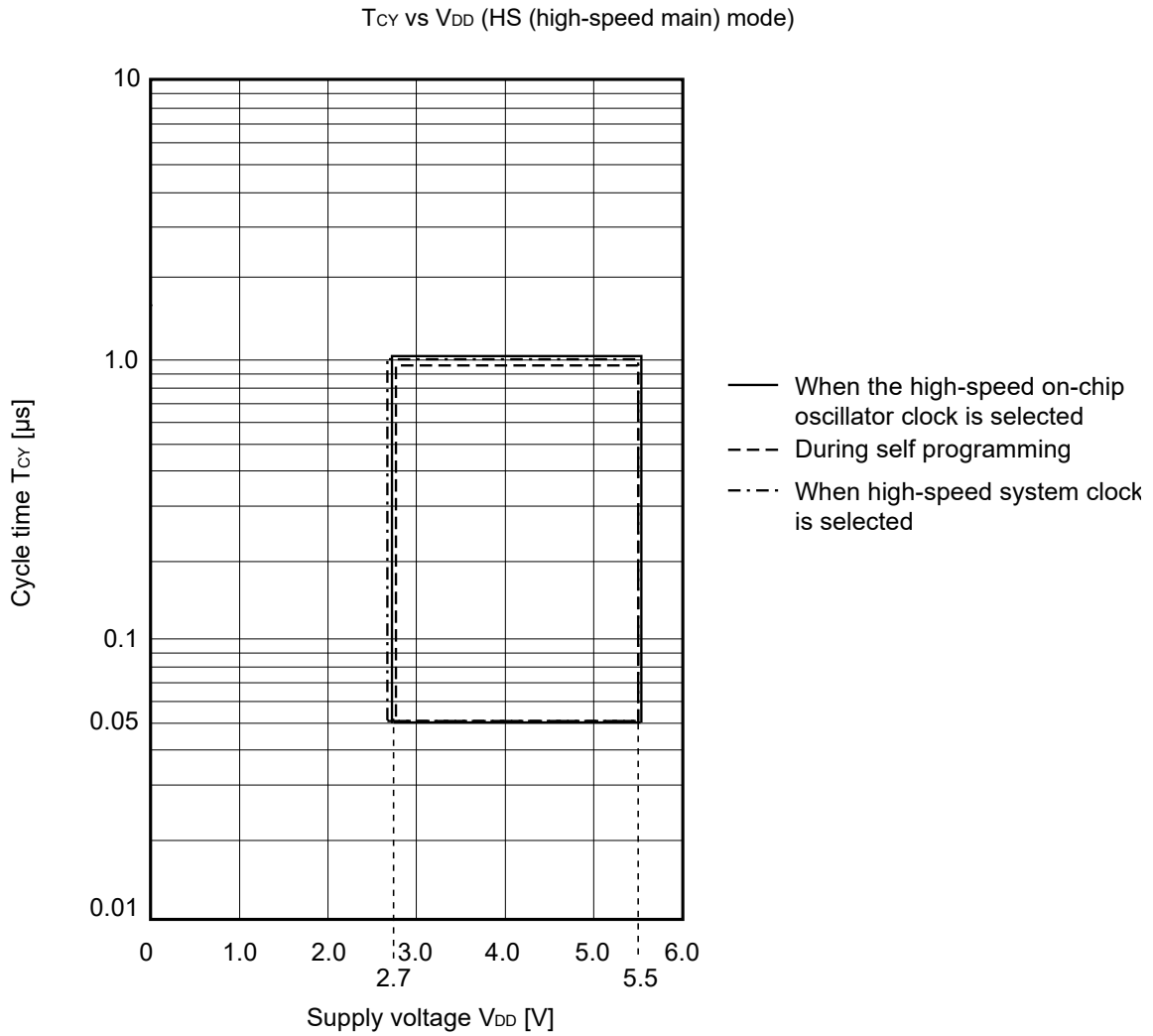

AC Timing Test Points

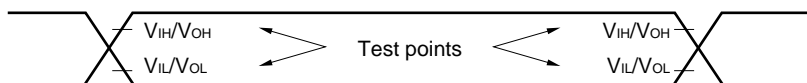

External System Clock Timing

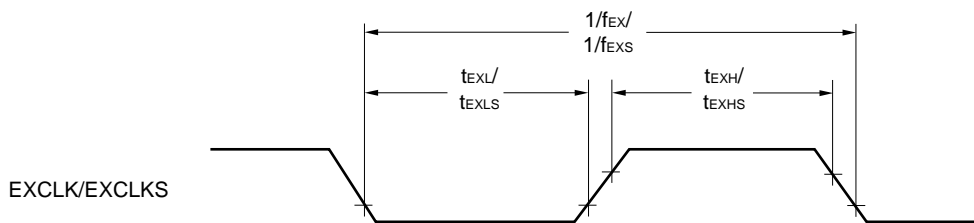

TI/TO Timing

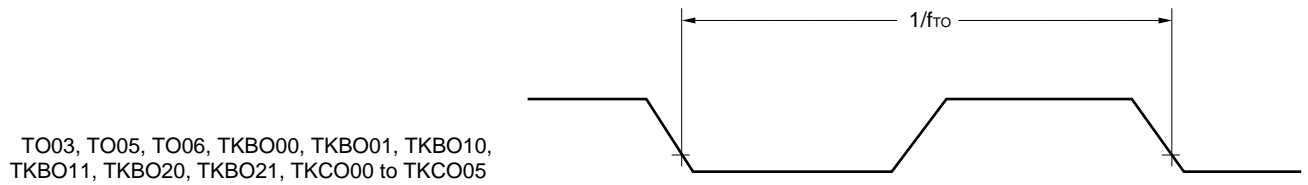
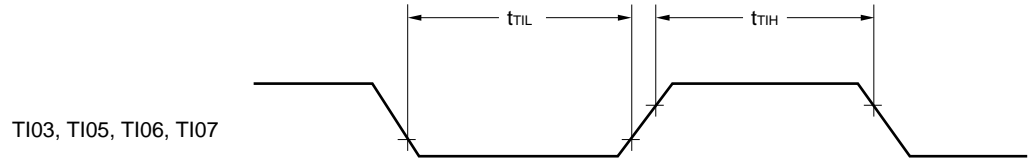

Interrupt Request Input Timing

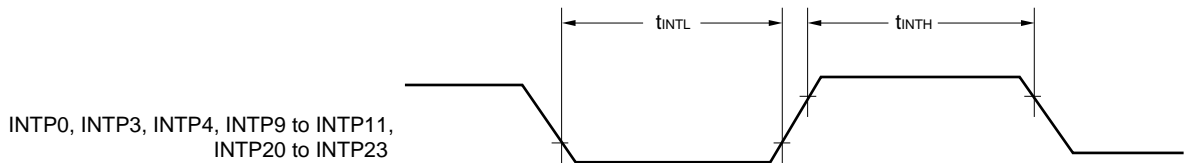

RESET Input Timing

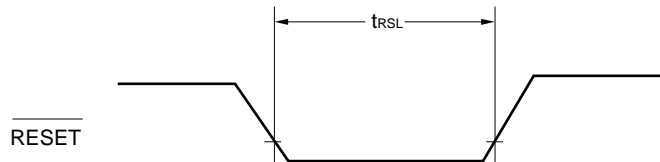

3.5 Peripheral Functions Characteristics

AC Timing Test Points

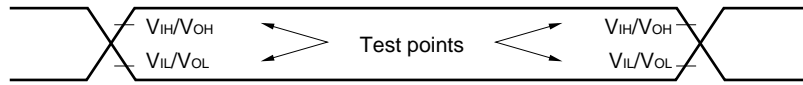

3.5.1 Serial array unit 0, 4 (UART0, UART1, CSI00, DALI/UART4)

(1) During communication at same potential (UART mode)

(T_A = -40 to +125°C, 2.7 V ≤ V_{DD} ≤ 5.5 V, V_{SS} = 0 V)

Parameter	Symbol	Conditions	HS (high-speed main) Mode		Unit
			MIN.	MAX.	
Transfer rate ^{Note 1}		Theoretical value of the maximum transfer rate f _{MCK} = f _{CLK} ^{Note 2}		f _{MCK} /6	bps
				3.3	Mbps

Notes 1. Transfer rate in the SNOOZE mode is 4800 bps only.

2. The operating frequencies of the CPU/peripheral hardware clock (f_{CLK}) are:

HS (high-speed main) mode: 20 MHz (2.7 V ≤ V_{DD} ≤ 5.5 V)

UART mode connection diagram (during communication at same potential)

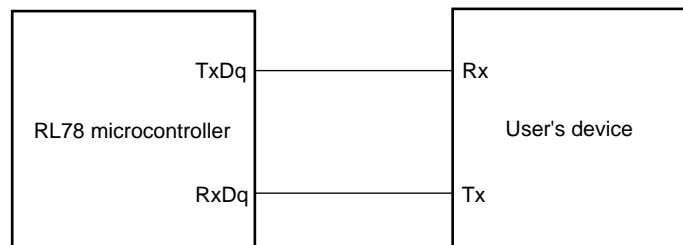

UART mode bit width (during communication at same potential) (reference)

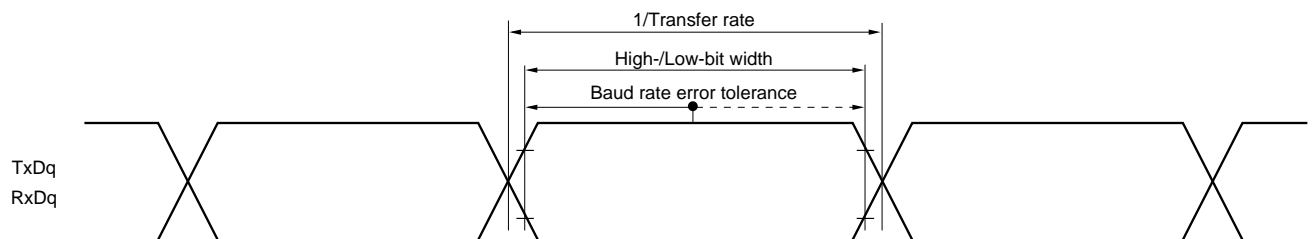

Caution Select the normal input buffer for the RxDq pin and the normal output mode for the TxDq pin by using port input mode register g (PIMg) and port output mode register g (POMg).

Remarks 1. q: UART number (q = 0, 1), g: PIM and POM number (g = 0, 1)

2. f_{MCK}: Serial array unit operation clock frequency

(Operation clock to be set by the CKSmn bit of serial mode register mn (SMRmn). m: Unit number,

n: Channel number (mn = 00 to 03))

(2) During communication at same potential (CSI mode) (master mode, SCKp... internal clock output)**($T_A = -40$ to $+125^\circ\text{C}$, $2.7\text{ V} \leq V_{DD} \leq 5.5\text{ V}$, $V_{SS} = 0\text{ V}$)**

Parameter	Symbol	Conditions	HS (high-speed main) Mode		Unit	
			MIN.	MAX.		
SCKp cycle time	t_{KCY1}	$t_{KCY1} \geq 4/f_{CLK}$	$4.0\text{ V} \leq V_{DD} \leq 5.5\text{ V}$	250		ns
			$2.7\text{ V} \leq V_{DD} \leq 5.5\text{ V}$	500		ns
SCKp high-/low-level width	t_{KH1} , t_{KL1}	$4.0\text{ V} \leq V_{DD} \leq 5.5\text{ V}$	$t_{KCY1}/2 - 20$			ns
		$2.7\text{ V} \leq V_{DD} \leq 5.5\text{ V}$	$t_{KCY1}/2 - 40$			ns
Slp setup time (to SCKp \uparrow) ^{Note 1}	t_{SIK1}	$4.0\text{ V} \leq V_{DD} \leq 5.5\text{ V}$	80			ns
		$2.7\text{ V} \leq V_{DD} \leq 5.5\text{ V}$	80			ns
Slp hold time (from SCKp \uparrow) ^{Note 2}	t_{KSI1}		40			ns
Delay time from SCKp \downarrow to SOp output ^{Note 3}	t_{KSO1}	$C = 30\text{ pF}$ ^{Note 4}		80		ns

- Notes**
1. When $DAPmn = 0$ and $CKPmn = 0$, or $DAPmn = 1$ and $CKPmn = 1$. The Slp setup time becomes “to SCKp \downarrow ” when $DAPmn = 0$ and $CKPmn = 1$, or $DAPmn = 1$ and $CKPmn = 0$.
 2. When $DAPmn = 0$ and $CKPmn = 0$, or $DAPmn = 1$ and $CKPmn = 1$. The Slp hold time becomes “from SCKp \downarrow ” when $DAPmn = 0$ and $CKPmn = 1$, or $DAPmn = 1$ and $CKPmn = 0$.
 3. When $DAPmn = 0$ and $CKPmn = 0$, or $DAPmn = 1$ and $CKPmn = 1$. The delay time to SOp output becomes “from SCKp \uparrow ” when $DAPmn = 0$ and $CKPmn = 1$, or $DAPmn = 1$ and $CKPmn = 0$.
 4. C is the load capacitance of the SCKp and SOp output lines.

Caution Select the normal input buffer for the Slp pin and the normal output mode for the SOp pin and SCKp pin by using port input mode register g (PIMg) and port output mode register g (POMg).

- Remarks**
1. p: CSI number (p = 00), m: Unit number (m = 0), n: Channel number (n = 0),
g: PIM and POM number (g = 1)
 2. f_{MCK} : Serial array unit operation clock frequency
(Operation clock to be set by the CKSmn bit of serial mode register mn (SMRmn). m: Unit number, n: Channel number (mn = 00))

(3) During communication at same potential (CSI mode) (slave mode, SCKp... external clock input)

(T_A = -40 to +125°C, 2.7 V ≤ V_{DD} ≤ 5.5 V, V_{SS} = 0 V)

Parameter	Symbol	Conditions		HS (high-speed main) Mode		Unit
				MIN.	MAX.	
SCKp cycle time ^{Note 5}	t _{KCV2}	4.0 V ≤ V _{DD} ≤ 5.5 V	f _{MCK} ≤ 20 MHz	6/f _{MCK}		ns
		2.7 V ≤ V _{DD} ≤ 5.5 V	16 MHz < f _{MCK}	8/f _{MCK}		ns
			f _{MCK} ≤ 16 MHz	6/f _{MCK}		ns
SCKp high-/low-level width	t _{KH2} , t _{KL2}			t _{KCV2} /2		ns
Slp setup time (to SCKp↑) ^{Note 1}	t _{SIK2}			1/f _{MCK} +40		ns
Slp hold time (from SCKp↑) ^{Note 2}	t _{KS12}			1/f _{MCK} +60		ns
Delay time from SCKp↓ to SOP output ^{Note 3}	t _{KSO2}	C = 30 pF ^{Note 4}			2/f _{MCK} +80	ns

- Notes**
1. When DAPmn = 0 and CKPmn = 0, or DAPmn = 1 and CKPmn = 1. The Slp setup time becomes “to SCKp↓” when DAPmn = 0 and CKPmn = 1, or DAPmn = 1 and CKPmn = 0.
 2. When DAPmn = 0 and CKPmn = 0, or DAPmn = 1 and CKPmn = 1. The Slp hold time becomes “from SCKp↓” when DAPmn = 0 and CKPmn = 1, or DAPmn = 1 and CKPmn = 0.
 3. When DAPmn = 0 and CKPmn = 0, or DAPmn = 1 and CKPmn = 1. The delay time to SOP output becomes “from SCKp↑” when DAPmn = 0 and CKPmn = 1, or DAPmn = 1 and CKPmn = 0.
 4. C is the load capacitance of the SOP output lines.
 5. Transfer rate in the SNOOZE mode: MAX. 1 Mbps

Caution Select the normal input buffer for the Slp pin and SCKp pin and the normal output mode for the SOP pin by using port input mode register g (PIMg) and port output mode register g (POMg).

- Remarks**
1. p: CSI number (p = 00), m: Unit number (m = 0), n: Channel number (n = 0),
g: PIM and POM number (g = 1)
 2. f_{MCK}: Serial array unit operation clock frequency
(Operation clock to be set by the CKSmn bit of serial mode register mn (SMRmn). m: Unit number, n: Channel number (mn = 00))

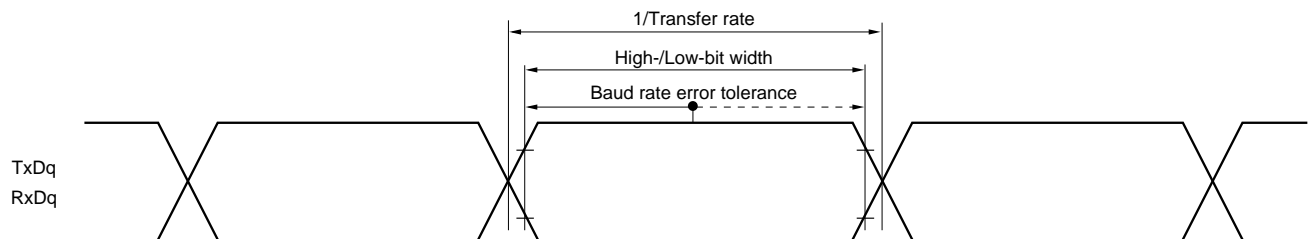

CSI mode connection diagram (during communication at same potential)

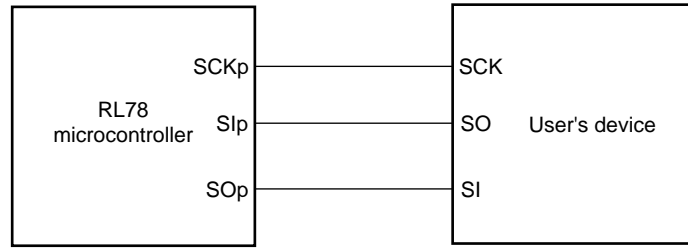

**CSI mode serial transfer timing (during communication at same potential)
(When DAPmn = 0 and CKPmn = 0, or DAPmn = 1 and CKPmn = 1.)**

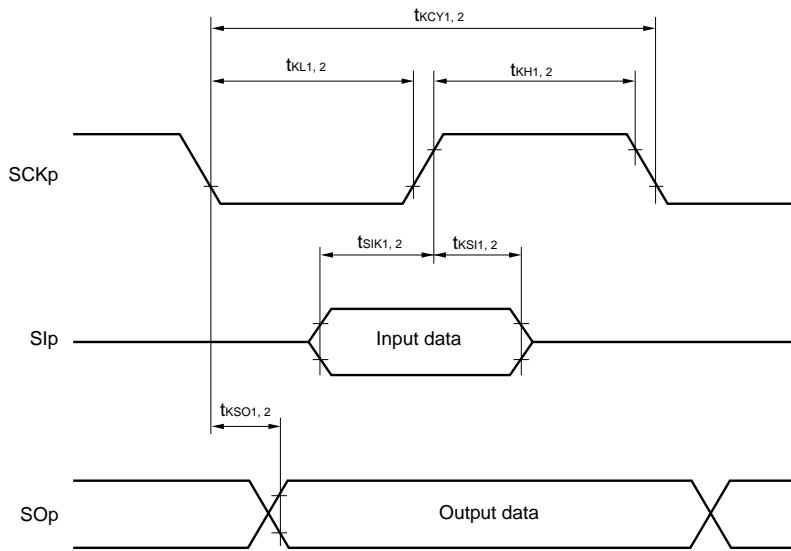

**CSI mode serial transfer timing (during communication at same potential)
(When DAPmn = 0 and CKPmn = 1, or DAPmn = 1 and CKPmn = 0.)**

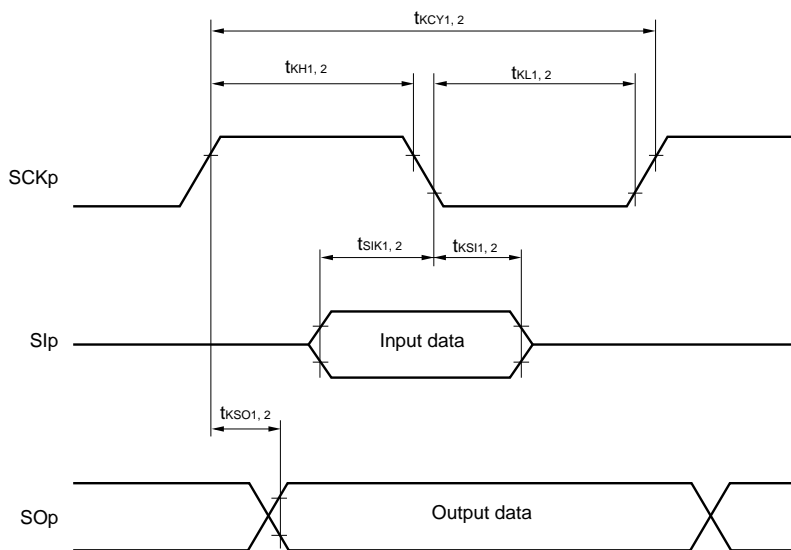

- Remarks 1. p: CSI number (p = 00)
- 2. m: Unit number, n: Channel number (mn = 00)

(4) Communication at different potential (2.5 V, 3 V) (UART mode) (1/2)**($T_A = -40$ to $+125^\circ\text{C}$, $2.7\text{ V} \leq V_{DD} \leq 5.5\text{ V}$, $V_{SS} = 0\text{ V}$)**

Parameter	Symbol	Conditions		HS (high-speed main) Mode		Unit
				MIN.	MAX.	
Transfer rate		Reception	$4.0\text{ V} \leq V_{DD} \leq 5.5\text{ V}$, $2.7\text{ V} \leq V_b \leq 4.0\text{ V}$		$f_{MCK}/6$ Note 1	bps
				Theoretical value of the maximum transfer rate $f_{MCK} = f_{CLK}$ Note 2		3.3
			$2.7\text{ V} \leq V_{DD} < 4.0\text{ V}$, $2.3\text{ V} \leq V_b \leq 2.7\text{ V}$		$f_{MCK}/6$ Note 1	bps
				Theoretical value of the maximum transfer rate $f_{MCK} = f_{CLK}$ Note 2		3.3

Notes 1. Transfer rate in the SNOOZE mode is 4800 bps only.

2. The operating frequencies of the CPU/peripheral hardware clock (f_{CLK}) are:

HS (high-speed main) mode: 20 MHz ($2.7\text{ V} \leq V_{DD} \leq 5.5\text{ V}$)

Caution Select the TTL input buffer for the RxDq pin and the N-ch open drain output (V_{DD} tolerance) mode for the TxDq pin by using port input mode register g (PIMg) and port output mode register g (POMg).

Remarks 1. $V_b[V]$: Communication line voltage

2. q: UART number (q = 0, 1), g: PIM and POM number (g = 0, 1)

3. f_{MCK} : Serial array unit operation clock frequency

(Operation clock to be set by the CKSmn bit of serial mode register mn (SMRmn). m: Unit number,

n: Channel number (mn = 00 to 03)

(4) Communication at different potential (2.5 V, 3 V) (UART mode) (2/2)(T_A = -40 to +125°C, 2.7 V ≤ V_{DD} ≤ 5.5 V, V_{SS} = 0 V)

Parameter	Symbol	Conditions		HS (high-speed main) Mode		Unit
				MIN.	MAX.	
Transfer rate		Transmission	4.0 V ≤ V _{DD} ≤ 5.5 V, 2.7 V ≤ V _b ≤ 4.0 V		Note 1	bps
				Theoretical value of the maximum transfer rate C _b = 50 pF, R _b = 1.4 kΩ, V _b = 2.7 V		2.8 ^{Note 2}
			2.7 V ≤ V _{DD} < 4.0 V, 2.3 V ≤ V _b ≤ 2.7 V		Note 3	bps
				Theoretical value of the maximum transfer rate C _b = 50 pF, R _b = 2.7 kΩ, V _b = 2.3 V		1.2 ^{Note 4}

Notes 1. The smaller maximum transfer rate derived by using f_{mck}/6 or the following expression is the valid maximum transfer rate.

Expression for calculating the transfer rate when 4.0 V ≤ V_{DD} ≤ 5.5 V and 2.7 V ≤ V_b ≤ 4.0 V

$$\text{Maximum transfer rate} = \frac{1}{\{-C_b \times R_b \times \ln(1 - \frac{2.2}{V_b})\} \times 3} \text{ [bps]}$$

$$\text{Baud rate error (theoretical value)} = \frac{\frac{1}{\text{Transfer rate} \times 2} - \{-C_b \times R_b \times \ln(1 - \frac{2.2}{V_b})\}}{(\frac{1}{\text{Transfer rate}}) \times \text{Number of transferred bits}} \times 100 \text{ [%]}$$

* This value is the theoretical value of the relative difference between the transmission and reception sides.

2. This value as an example is calculated when the conditions described in the “Conditions” column are met. See **Note 1** above to calculate the maximum transfer rate under conditions of the customer.

3. The smaller maximum transfer rate derived by using f_{mck}/6 or the following expression is the valid maximum transfer rate.

Expression for calculating the transfer rate when 2.7 V ≤ V_{DD} < 4.0 V and 2.3 V ≤ V_b ≤ 2.7 V

$$\text{Maximum transfer rate} = \frac{1}{\{-C_b \times R_b \times \ln(1 - \frac{2.0}{V_b})\} \times 3} \text{ [bps]}$$

$$\text{Baud rate error (theoretical value)} = \frac{\frac{1}{\text{Transfer rate} \times 2} - \{-C_b \times R_b \times \ln(1 - \frac{2.0}{V_b})\}}{(\frac{1}{\text{Transfer rate}}) \times \text{Number of transferred bits}} \times 100 \text{ [%]}$$

* This value is the theoretical value of the relative difference between the transmission and reception sides.

4. This value as an example is calculated when the conditions described in the “Conditions” column are met. See **Note 3** above to calculate the maximum transfer rate under conditions of the customer.

Caution Select the TTL input buffer for the RxDq pin and the N-ch open drain output (V_{DD} tolerance) mode for the TxDq pin by using port input mode register g (PIMg) and port output mode register g (POMg).

- Remarks 1.** R_b[Ω]: Communication line (TxDq) pull-up resistance,
C_b[F]: Communication line (TxDq) load capacitance, V_b[V]: Communication line voltage
- 2.** q: UART number (q = 0, 1), g: PIM and POM number (g = 0, 1)
- 3.** f_{mck}: Serial array unit operation clock frequency
(Operation clock to be set by the CKSmn bit of serial mode register mn (SMRmn).
m: Unit number, n: Channel number (mn = 00 to 03))

UART mode connection diagram (during communication at different potential)

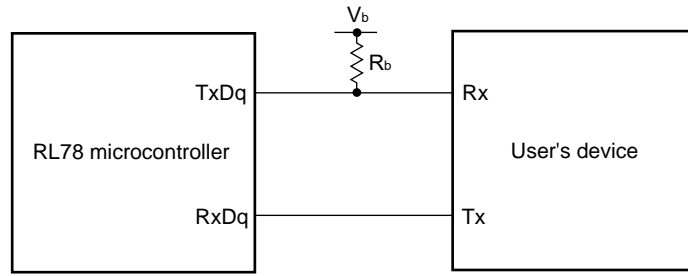

UART mode bit width (during communication at different potential) (reference)

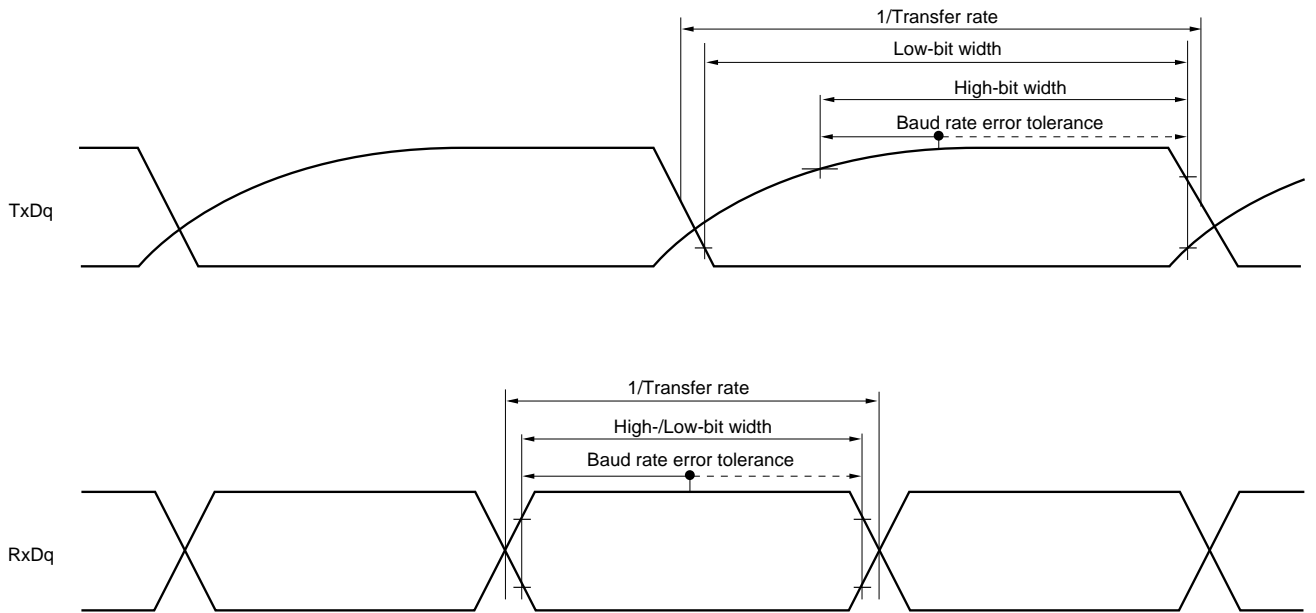

Caution Select the TTL input buffer for the RxDq pin and the N-ch open drain output (V_{DD} tolerance) mode for the TxDq pin by using port input mode register g (PIMg) and port output mode register g (POMg).

- Remarks**
1. $R_b[\Omega]$: Communication line (TxDq) pull-up resistance, $V_b[V]$: Communication line voltage
 2. q: UART number (q = 0, 1), g: PIM and POM number (g = 0, 1)

(5) Communication at different potential (2.5 V, 3 V) (CSI mode) (master mode, SCKp... internal clock output)
($T_A = -40$ to $+125^\circ\text{C}$, $2.7\text{ V} \leq V_{DD} \leq 5.5\text{ V}$, $V_{SS} = 0\text{ V}$)

Parameter	Symbol	Conditions	HS (high-speed main) Mode		Unit
			MIN.	MAX.	
SCKp cycle time	t_{KCY1}	$t_{KCY1} \geq 4/f_{CLK}$ $4.0\text{ V} \leq V_{DD} \leq 5.5\text{ V}$, $2.7\text{ V} \leq V_b \leq 4.0\text{ V}$, $C_b = 30\text{ pF}$, $R_b = 1.4\text{ k}\Omega$	600		ns
		$2.7\text{ V} \leq V_{DD} < 4.0\text{ V}$, $2.3\text{ V} \leq V_b \leq 2.7\text{ V}$, $C_b = 30\text{ pF}$, $R_b = 2.7\text{ k}\Omega$	1000		ns
SCKp high-level width	t_{KH1}	$4.0\text{ V} \leq V_{DD} \leq 5.5\text{ V}$, $2.7\text{ V} \leq V_b \leq 4.0\text{ V}$, $C_b = 30\text{ pF}$, $R_b = 1.4\text{ k}\Omega$	$t_{KCY1}/2 - 80$		ns
		$2.7\text{ V} \leq V_{DD} < 4.0\text{ V}$, $2.3\text{ V} \leq V_b \leq 2.7\text{ V}$, $C_b = 30\text{ pF}$, $R_b = 2.7\text{ k}\Omega$	$t_{KCY1}/2 - 170$		ns
SCKp low-level width	t_{KL1}	$4.0\text{ V} \leq V_{DD} \leq 5.5\text{ V}$, $2.7\text{ V} \leq V_b \leq 4.0\text{ V}$, $C_b = 30\text{ pF}$, $R_b = 1.4\text{ k}\Omega$	$t_{KCY1}/2 - 28$		ns
		$2.7\text{ V} \leq V_{DD} < 4.0\text{ V}$, $2.3\text{ V} \leq V_b \leq 2.7\text{ V}$, $C_b = 30\text{ pF}$, $R_b = 2.7\text{ k}\Omega$	$t_{KCY1}/2 - 40$		ns
Slp setup time (to SCKp \uparrow) ^{Note 1}	t_{SIK1}	$4.0\text{ V} \leq V_{DD} \leq 5.5\text{ V}$, $2.7\text{ V} \leq V_b \leq 4.0\text{ V}$, $C_b = 30\text{ pF}$, $R_b = 1.4\text{ k}\Omega$	160		ns
		$2.7\text{ V} \leq V_{DD} < 4.0\text{ V}$, $2.3\text{ V} \leq V_b \leq 2.7\text{ V}$, $C_b = 30\text{ pF}$, $R_b = 2.7\text{ k}\Omega$	250		ns
Slp hold time (from SCKp \uparrow) ^{Note 1}	t_{SH1}	$4.0\text{ V} \leq V_{DD} \leq 5.5\text{ V}$, $2.7\text{ V} \leq V_b \leq 4.0\text{ V}$, $C_b = 30\text{ pF}$, $R_b = 1.4\text{ k}\Omega$	40		ns
		$2.7\text{ V} \leq V_{DD} < 4.0\text{ V}$, $2.3\text{ V} \leq V_b \leq 2.7\text{ V}$, $C_b = 30\text{ pF}$, $R_b = 2.7\text{ k}\Omega$	40		ns
Delay time from SCKp \downarrow to SOP output ^{Note 1}	t_{KSO1}	$4.0\text{ V} \leq V_{DD} \leq 5.5\text{ V}$, $2.7\text{ V} \leq V_b \leq 4.0\text{ V}$, $C_b = 30\text{ pF}$, $R_b = 1.4\text{ k}\Omega$		160	ns
		$2.7\text{ V} \leq V_{DD} < 4.0\text{ V}$, $2.3\text{ V} \leq V_b \leq 2.7\text{ V}$, $C_b = 30\text{ pF}$, $R_b = 2.7\text{ k}\Omega$		250	ns
Slp setup time (to SCKp \downarrow) ^{Note 2}	t_{SIK1}	$4.0\text{ V} \leq V_{DD} \leq 5.5\text{ V}$, $2.7\text{ V} \leq V_b \leq 4.0\text{ V}$, $C_b = 30\text{ pF}$, $R_b = 1.4\text{ k}\Omega$	80		ns
		$2.7\text{ V} \leq V_{DD} < 4.0\text{ V}$, $2.3\text{ V} \leq V_b \leq 2.7\text{ V}$, $C_b = 30\text{ pF}$, $R_b = 2.7\text{ k}\Omega$	80		ns
Slp hold time (from SCKp \downarrow) ^{Note 2}	t_{SH1}	$4.0\text{ V} \leq V_{DD} \leq 5.5\text{ V}$, $2.7\text{ V} \leq V_b \leq 4.0\text{ V}$, $C_b = 30\text{ pF}$, $R_b = 1.4\text{ k}\Omega$	40		ns
		$2.7\text{ V} \leq V_{DD} < 4.0\text{ V}$, $2.3\text{ V} \leq V_b \leq 2.7\text{ V}$, $C_b = 30\text{ pF}$, $R_b = 2.7\text{ k}\Omega$	40		ns
Delay time from SCKp \uparrow to SOP output ^{Note 2}	t_{KSO1}	$4.0\text{ V} \leq V_{DD} \leq 5.5\text{ V}$, $2.7\text{ V} \leq V_b \leq 4.0\text{ V}$, $C_b = 30\text{ pF}$, $R_b = 1.4\text{ k}\Omega$		80	ns
		$2.7\text{ V} \leq V_{DD} < 4.0\text{ V}$, $2.3\text{ V} \leq V_b \leq 2.7\text{ V}$, $C_b = 30\text{ pF}$, $R_b = 2.7\text{ k}\Omega$		80	ns

- Notes**
1. When $DAP_{mn} = 0$ and $CKP_{mn} = 0$, or $DAP_{mn} = 1$ and $CKP_{mn} = 1$.
 2. When $DAP_{mn} = 0$ and $CKP_{mn} = 1$, or $DAP_{mn} = 1$ and $CKP_{mn} = 0$.

(Caution and Remarks are listed on the next page.)

Caution Select the TTL input buffer for the SIp pin and the N-ch open drain output (V_{DD} tolerance) mode for the SOp pin and SCKp pin by using port input mode register g (PIMg) and port output mode register g (POMg). For V_{IH} and V_{IL} , see the DC characteristics with TTL input buffer selected.

CSI mode connection diagram (during communication at different potential)

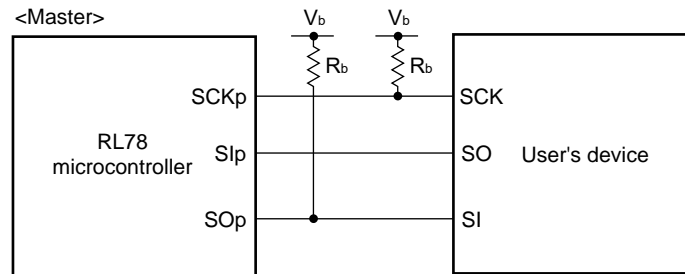

- Remarks**
- $R_b[\Omega]$: Communication line (SCKp, SOp) pull-up resistance, $C_b[\text{F}]$: Communication line (SCKp, SOp) load capacitance, $V_b[\text{V}]$: Communication line voltage
 - p: CSI number ($p = 00$), m: Unit number ($m = 0$), n: Channel number ($n = 0$), g: PIM and POM number ($g = 1$)

CSI mode serial transfer timing (master mode) (during communication at different potential)
(When DAPmn = 0 and CKPmn = 0, or DAPmn = 1 and CKPmn = 1.)

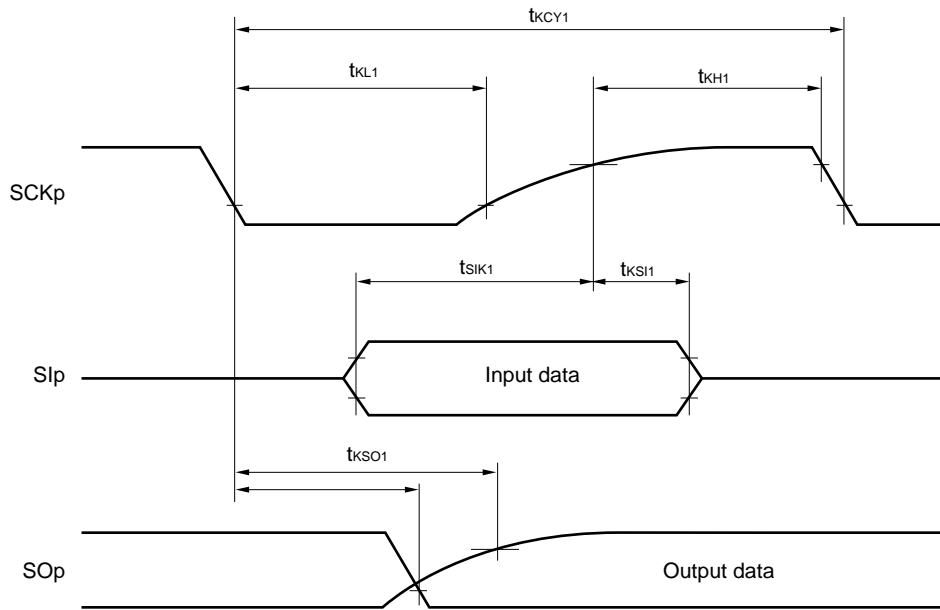

CSI mode serial transfer timing (master mode) (during communication at different potential)
(When DAPmn = 0 and CKPmn = 1, or DAPmn = 1 and CKPmn = 0.)

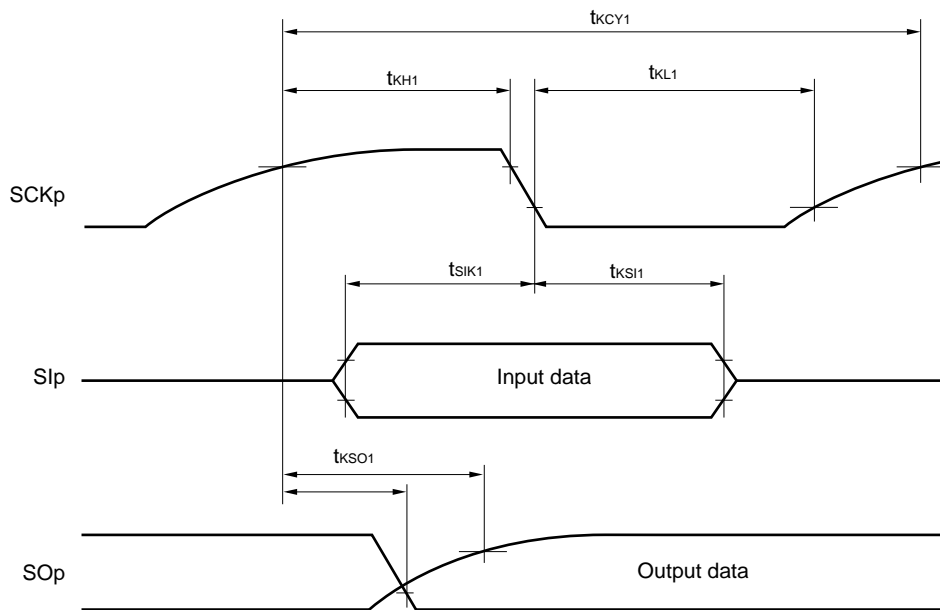

Caution Select the TTL input buffer for the SIp pin and the N-ch open drain output (V_{DD} tolerance) mode for the SOp pin and SCKp pin by using port input mode register g (PIMg) and port output mode register g (POMg).

Remark p: CSI number (p = 00), m: Unit number (m = 0), n: Channel number (n = 0), g: PIM and POM number (g = 1)

(6) DALI/UART4 mode**($T_A = -40$ to $+125^\circ\text{C}$, $2.7\text{ V} \leq V_{DD} \leq 5.5\text{ V}$, $V_{SS} = 0\text{ V}$)**

Parameter	Symbol	Conditions	HS (high-speed main) Mode		Unit
			MIN.	MAX.	
Transfer rate		Maximum transfer rate theoretical value $f_{\text{CLK}} = 20\text{ MHz}$, $f_{\text{MCK}} = f_{\text{CLK}}$		$f_{\text{MCK}}/12$	bps
				1.6	Mbps

Remark f_{MCK} : Operation clock frequency of DALI/UART.

(Operation clock to be set by the serial clock select register 4 (SPS4).)

3.5.2 Serial interface IICA

(1) I²C standard mode(T_A = -40 to $+125^\circ\text{C}$, $2.7\text{ V} \leq V_{\text{DD}} \leq 5.5\text{ V}$, $V_{\text{SS}} = 0\text{ V}$)

Parameter	Symbol	Conditions	HS (high-speed main) Mode		Unit
			MIN.	MAX.	
SCLA0 clock frequency	f _{SCL}	Standard mode: f _{CLK} ≥ 1 MHz	0	100	kHz
Setup time of restart condition	t _{SU:STA}		4.7		μs
Hold time ^{Note 1}	t _{HD:STA}		4.0		μs
Hold time when SCLA0 = "L"	t _{LOW}		4.7		μs
Hold time when SCLA0 = "H"	t _{HIGH}		4.0		μs
Data setup time (reception)	t _{SU:DAT}		250		ns
Data hold time (transmission) ^{Note 2}	t _{HD:DAT}		0	3.45	μs
Setup time of stop condition	t _{SU:STO}		4.0		μs
Bus-free time	t _{BUF}		4.7		μs

- Notes**
1. The first clock pulse is generated after this period when the start/restart condition is detected.
 2. The maximum value (MAX.) of t_{HD:DAT} is during normal transfer and a wait state is inserted in the ACK (acknowledge) timing.

Remark The maximum value of C_b (communication line capacitance) and the value of R_b (communication line pull-up resistor) at that time in each mode are as follows.

Standard mode: C_b = 400 pF, R_b = 2.7 kΩ

(2) I²C fast mode

($T_A = -40$ to $+125^\circ\text{C}$, $2.7\text{ V} \leq V_{DD} \leq 5.5\text{ V}$, $V_{SS} = 0\text{ V}$)

Parameter	Symbol	Conditions	HS (high-speed main) Mode		Unit
			MIN.	MAX.	
SCLA0 clock frequency	f_{SCL}	fast mode: $f_{CLK} \geq 3.5\text{ MHz}$	0	400	kHz
Setup time of restart condition	$t_{SU:STA}$		0.6		μs
Hold time ^{Note 1}	$t_{HD:STA}$		0.6		μs
Hold time when SCLA0 = "L"	t_{LOW}		1.3		μs
Hold time when SCLA0 = "H"	t_{HIGH}		0.6		μs
Data setup time (reception)	$t_{SU:DAT}$		100		ns
Data hold time (transmission) ^{Note 2}	$t_{HD:DAT}$		0	0.9	μs
Setup time of stop condition	$t_{SU:STO}$		0.6		μs
Bus-free time	t_{BUF}		1.3		μs

- Notes**
- The first clock pulse is generated after this period when the start/restart condition is detected.
 - The maximum value (MAX.) of $t_{HD:DAT}$ is during normal transfer and a wait state is inserted in the ACK (acknowledge) timing.

Remark The maximum value of C_b (communication line capacitance) and the value of R_b (communication line pull-up resistor) at that time in each mode are as follows.

fast mode: $C_b = 320\text{ pF}$, $R_b = 1.1\text{ k}\Omega$

I²C serial transfer timing

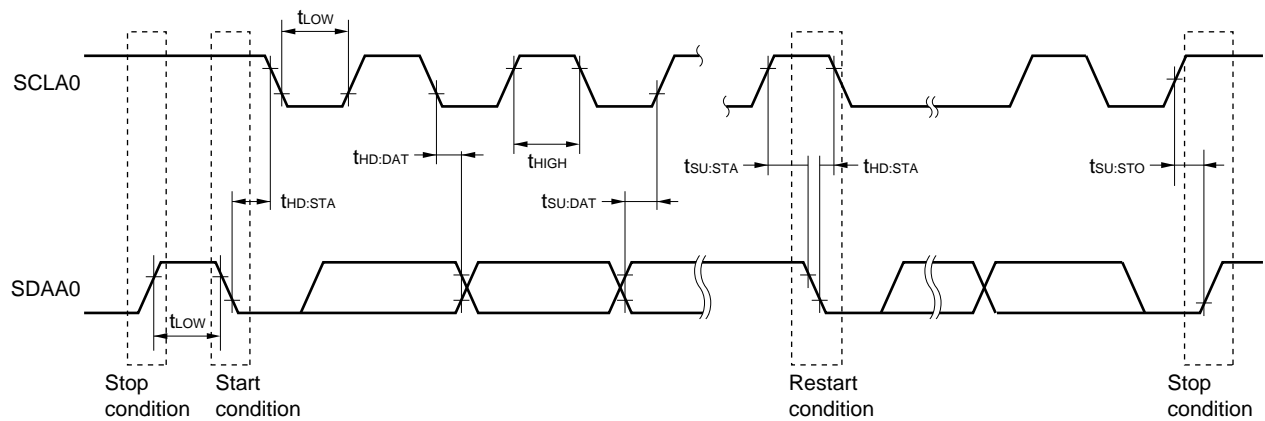

3.6 Analog Characteristics

3.6.1 A/D converter characteristics

Classification of A/D converter characteristics

Input channel	Reference Voltage		
	Reference voltage (+) = AV_{REFP} Reference voltage (-) = AV_{REFM}	Reference voltage (+) = V_{DD} Reference voltage (-) = V_{SS}	Reference voltage (+) = V_{BGR} Reference voltage (-) = AV_{REFM}
ANI0 to ANI2, ANI4 to ANI7	See 3.6.1 (1) .	See 3.6.1 (3) .	See 3.6.1 (4) .
ANI16 to ANI19	See 3.6.1 (2) .		
Internal reference voltage Temperature sensor output voltage	See 3.6.1 (1) .		–

(1) When reference voltage (+) = $AV_{REFP}/ANI0$ ($ADREFP1 = 0$, $ADREFP0 = 1$), reference voltage (-) = $AV_{REFM}/ANI1$ ($ADREFM = 1$), target ANI pin: ANI2, ANI4 to ANI7, internal reference voltage, and temperature sensor output voltage

($T_A = -40$ to $+125^\circ\text{C}$, $2.7\text{ V} \leq AV_{REFP} \leq V_{DD} \leq 5.5\text{ V}$, $V_{SS} = 0\text{ V}$, Reference voltage (+) = AV_{REFP} , Reference voltage (-) = $AV_{REFM} = 0\text{ V}$)

Parameter	Symbol	Conditions	MIN.	TYP.	MAX.	Unit	
Resolution	RES		8		10	bit	
Overall error ^{Note 1}	AINL	10-bit resolution $AV_{REFP} = V_{DD}$ ^{Note 3}		1.2	± 3.5	LSB	
Conversion time	t_{CONV}	10-bit resolution Target pin: ANI2, ANI4 to ANI7	$3.6\text{ V} \leq V_{DD} \leq 5.5\text{ V}$	2.125		39	μs
			$2.7\text{ V} \leq V_{DD} \leq 5.5\text{ V}$	3.4		39	μs
		10-bit resolution Target pin: Internal reference voltage, and temperature sensor output voltage (HS (high-speed main) mode)	$3.6\text{ V} \leq V_{DD} \leq 5.5\text{ V}$	2.375		39	μs
			$2.7\text{ V} \leq V_{DD} \leq 5.5\text{ V}$	3.8		39	μs
Zero-scale error ^{Notes 1, 2}	E _{ZS}	10-bit resolution $AV_{REFP} = V_{DD}$ ^{Note 3}			± 0.25	%FSR	
Full-scale error ^{Notes 1, 2}	E _{FS}	10-bit resolution $AV_{REFP} = V_{DD}$ ^{Note 3}			± 0.25	%FSR	
Integral linearity error ^{Note 1}	ILE	10-bit resolution $AV_{REFP} = V_{DD}$ ^{Note 3}			± 2.5	LSB	
Differential linearity error ^{Note 1}	DLE	10-bit resolution $AV_{REFP} = V_{DD}$ ^{Note 3}			± 1.5	LSB	
Analog input voltage	V_{AIN}	ANI2, ANI4 to ANI7	0		AV_{REFP}	V	
		Internal reference voltage (HS (high-speed main) mode)	V_{BGR} ^{Note 4}			V	
		Temperature sensor output voltage (HS (high-speed main) mode)	V_{TMPS25} ^{Note 4}			V	

Notes 1. Excludes quantization error ($\pm 1/2$ LSB).

2. This value is indicated as a ratio (%FSR) to the full-scale value.

3. When $AV_{REFP} < V_{DD}$, the MAX. values are as follows.

Overall error: Add ± 1.0 LSB to the MAX. value when $AV_{REFP} = V_{DD}$.

Zero-scale error/Full-scale error: Add $\pm 0.05\%$ FSR to the MAX. value when $AV_{REFP} = V_{DD}$.

Integral linearity error/Differential linearity error: Add ± 0.5 LSB to the MAX. value when $AV_{REFP} = V_{DD}$.

4. See 3.6.2 Temperature sensor/internal reference voltage characteristics.

(2) When reference voltage (+) = $AV_{REFP}/ANI0$ ($ADREFP1 = 0$, $ADREFP0 = 1$), reference voltage (-) = $AV_{REFM}/ANI1$ ($ADREFM = 1$), target pin: ANI16 to ANI19

($T_A = -40$ to $+125^\circ\text{C}$, $2.7\text{ V} \leq AV_{REFP} \leq V_{DD} \leq 5.5\text{ V}$, $V_{SS} = 0\text{ V}$, Reference voltage (+) = AV_{REFP} , Reference voltage (-) = $AV_{REFM} = 0\text{ V}$)

Parameter	Symbol	Conditions		MIN.	TYP.	MAX.	Unit
Resolution	RES			8		10	bit
Overall error ^{Note 1}	AINL	10-bit resolution $AV_{REFP} = V_{DD}$ ^{Note 3}			1.2	± 5.0	LSB
Conversion time	t_{CONV}	10-bit resolution Target ANI pin : ANI16 to ANI19	$3.6\text{ V} \leq V_{DD} \leq 5.5\text{ V}$	2.125		39	μs
			$2.7\text{ V} \leq V_{DD} < 5.5\text{ V}$	3.4		39	μs
Zero-scale error ^{Notes 1, 2}	E _{ZS}	10-bit resolution $AV_{REFP} = V_{DD}$ ^{Note 3}				± 0.35	%FSR
Full-scale error ^{Notes 1, 2}	E _{FS}	10-bit resolution $AV_{REFP} = V_{DD}$ ^{Note 3}				± 0.35	%FSR
Integral linearity error ^{Note 1}	ILE	10-bit resolution $AV_{REFP} = V_{DD}$ ^{Note 3}				± 3.5	LSB
Differential linearity error ^{Note 1}	DLE	10-bit resolution $AV_{REFP} = V_{DD}$ ^{Note 3}				± 2.0	LSB
Analog input voltage	V _{AIN}	ANI16 to ANI19		0		AV_{REFP} and V_{DD}	V

Notes 1. Excludes quantization error ($\pm 1/2$ LSB).

2. This value is indicated as a ratio (%FSR) to the full-scale value.

3. When $AV_{REFP} < V_{DD}$, the MAX. values are as follows.

Overall error: Add ± 4.0 LSB to the MAX. value when $AV_{REFP} = V_{DD}$.

Zero-scale error/Full-scale error: Add $\pm 0.2\%$ FSR to the MAX. value when $AV_{REFP} = V_{DD}$.

Integral linearity error/Differential linearity error: Add ± 2.0 LSB to the MAX. value when $AV_{REFP} = V_{DD}$.

(3) When reference voltage (+) = V_{DD} (ADREFP1 = 0, ADREFP0 = 0), reference voltage (-) = V_{SS} (ADREFM = 0), target pin: ANI0 to ANI2, ANI4 to ANI7, ANI16 to ANI19, internal reference voltage, and temperature sensor output voltage

($T_A = -40$ to $+125^\circ\text{C}$, $2.7\text{ V} \leq V_{DD} \leq 5.5\text{ V}$, $V_{SS} = 0\text{ V}$, Reference voltage (+) = V_{DD} , Reference voltage (-) = V_{SS})

Parameter	Symbol	Conditions		MIN.	TYP.	MAX.	Unit	
Resolution	RES			8		10	bit	
Overall error ^{Note 1}	AINL	10-bit resolution			1.2	± 7.0	LSB	
Conversion time	t_{CONV}	10-bit resolution Target pin: ANI0 to ANI2, ANI4 to ANI7, ANI16 to ANI19	$3.6\text{ V} \leq V_{DD} \leq 5.5\text{ V}$	2.125		39	μs	
			$2.7\text{ V} \leq V_{DD} \leq 5.5\text{ V}$	3.4		39	μs	
Conversion time	t_{CONV}	10-bit resolution Target pin: Internal reference voltage, and temperature sensor output voltage (HS (high-speed main) mode)	$3.6\text{ V} \leq V_{DD} \leq 5.5\text{ V}$	2.375		39	μs	
			$2.7\text{ V} \leq V_{DD} \leq 5.5\text{ V}$	3.8		39	μs	
Zero-scale error ^{Notes 1, 2}	E_{ZS}	10-bit resolution				± 0.60	%FSR	
Full-scale error ^{Notes 1, 2}	E_{FS}	10-bit resolution				± 0.60	%FSR	
Integral linearity error ^{Note 1}	ILE	10-bit resolution				± 4.0	LSB	
Differential linearity error ^{Note 1}	DLE	10-bit resolution				± 2.0	LSB	
Analog input voltage	V_{AIN}	ANI0 to ANI2, ANI4 to ANI7		0		V_{DD}	V	
		ANI16 to ANI19		0		V_{DD}	V	
		Internal reference voltage (HS (high-speed main) mode)		V_{BGR} ^{Note 3}				V
		Temperature sensor output voltage (HS (high-speed main) mode)		V_{TMPS25} ^{Note 3}				V

Notes 1. Excludes quantization error ($\pm 1/2$ LSB).

2. This value is indicated as a ratio (%FSR) to the full-scale value.

3. See 3.6.2 Temperature sensor/internal reference voltage characteristics.

(4) When reference voltage (+) = Internal reference voltage (ADREFP1 = 1, ADREFP0 = 0), reference voltage (-) = $AV_{REFM}/ANI1$ (ADREFM = 1), target pin: ANI0, ANI2, ANI4 to ANI7, ANI16 to ANI19

($T_A = -40$ to $+125^\circ\text{C}$, $2.7\text{ V} \leq V_{DD} \leq 5.5\text{ V}$, $V_{SS} = 0\text{ V}$, Reference voltage (+) = $V_{BGR}^{\text{Note 3}}$, Reference voltage (-) = $AV_{REFM}^{\text{Note 4}} = 0\text{ V}$, HS (high-speed main) mode)

Parameter	Symbol	Conditions	MIN.	TYP.	MAX.	Unit
Resolution	RES		8			bit
Conversion time	t_{CONV}	8-bit resolution	17		39	μs
Zero-scale error ^{Notes 1, 2}	E _{ZS}	8-bit resolution			± 0.60	%FSR
Integral linearity error ^{Note 1}	ILE	8-bit resolution			± 2.0	LSB
Differential linearity error ^{Note 1}	DLE	8-bit resolution			± 1.0	LSB
Analog input voltage	V_{AIN}		0		$V_{BGR}^{\text{Note 3}}$	V

Notes 1. Excludes quantization error ($\pm 1/2$ LSB).

2. This value is indicated as a ratio (%FSR) to the full-scale value.

3. See 3.6.2 Temperature sensor/internal reference voltage characteristics.

4. When reference voltage (-) = V_{SS} , the MAX. values are as follows.

Zero-scale error: Add $\pm 0.35\%$ FSR to the MAX. value when reference voltage (-) = AV_{REFM} .

Integral linearity error: Add ± 0.5 LSB to the MAX. value when reference voltage (-) = AV_{REFM} .

Differential linearity error: Add ± 0.2 LSB to the MAX. value when reference voltage (-) = AV_{REFM} .

3.6.2 Temperature sensor/internal reference voltage characteristics

($T_A = -40$ to $+125^\circ\text{C}$, $2.7\text{ V} \leq V_{DD} \leq 5.5\text{ V}$, $V_{SS} = 0\text{ V}$, HS (high-speed main) mode)

Parameter	Symbol	Conditions	MIN.	TYP.	MAX.	Unit
Temperature sensor output voltage	V_{TMPS25}	Setting ADS register = 80H, $T_A = +25^\circ\text{C}$		1.05		V
Internal reference voltage	V_{BGR}	Setting ADS register = 81H	1.38	1.45	1.5	V
Temperature coefficient	F_{VTMPS}	Temperature sensor that depends on the temperature		-3.6		mV/C
Operation stabilization wait time	t_{AMP}		5			μs

3.6.3 Programmable gain amplifier

 $(T_A = -40$ to $+125^\circ\text{C}$, $2.7\text{ V} \leq AV_{\text{REFP}} = V_{\text{DD}} \leq 5.5\text{ V}$, $V_{\text{SS}} = AV_{\text{REFM}} = 0\text{ V}$)

Parameter	Symbol	Conditions		MIN.	TYP.	MAX.	Unit
Input offset voltage	V_{IOPGA}				± 5	± 10	mV
Input voltage range	V_{IPGA}			0		$0.9V_{\text{DD}}/\text{gain}$	V
Gain error ^{Note 1}		4, 8 times				± 1	%
		16 times				± 1.5	%
		32 times				± 2	%
Slew rate ^{Note 1}	SR_{RPGA}	Rising edge	$4.0\text{ V} \leq V_{\text{DD}} \leq 5.5\text{ V}$	4, 8 times	4		$\text{V}/\mu\text{s}$
				16, 32 times	1.4		$\text{V}/\mu\text{s}$
			$2.7\text{ V} \leq V_{\text{DD}} < 4.0\text{ V}$	4, 8 times	1.8		$\text{V}/\mu\text{s}$
				16, 32 times	0.5		$\text{V}/\mu\text{s}$
	SR_{FPGA}	Falling edge	$4.0\text{ V} \leq V_{\text{DD}} \leq 5.5\text{ V}$	4, 8 times	3.2		$\text{V}/\mu\text{s}$
				16, 32 times	1.4		$\text{V}/\mu\text{s}$
		$2.7\text{ V} \leq V_{\text{DD}} < 4.0\text{ V}$	4, 8 times	1.2		$\text{V}/\mu\text{s}$	
			16, 32 times	0.5		$\text{V}/\mu\text{s}$	
Operation stabilization wait time ^{Note 2}	t_{PGA}	4, 8 times		5			μs
		16, 32 times		10			μs

Notes 1. When $V_{\text{IPGA}} = 0.1V_{\text{DD}}/\text{gain}$ to $0.9V_{\text{DD}}/\text{gain}$.

2. Time required until a state is entered where the DC and AC specifications of the PGA are satisfied after the PGA operation has been enabled ($\text{PGAEN} = 1$).

Remark These characteristics apply when AV_{REFM} is selected as GND of the PGA by using the CVRVS1 bit.

3.6.4 Comparator

($T_A = -40$ to $+125^\circ\text{C}$, $2.7\text{ V} \leq AV_{REFP} = V_{DD} \leq 5.5\text{ V}$, $V_{SS} = AV_{REFM} = 0\text{ V}$)

Parameter	Symbol	Conditions	MIN.	TYP.	MAX.	Unit
Input offset voltage	V_{IOCOMP}			± 5	± 40	mV
Input voltage range	V_{ICMP}	CMP0P to CMP5P	0		V_{DD}	V
		CMPCOM	0.045		$0.9V_{DD}$	V
Internal reference voltage deviation	ΔV_{IREF}	CmRVM register values: 7FH to 80H (m = 0 to 2)			± 2	LSB
		Other than above			± 1	LSB
Response time	t_{CR}, t_{CF}	Input amplitude = $\pm 100\text{ mV}$		70	150	ns
Operation stabilization wait time ^{Note 1}	t_{CMP}	$3.3\text{ V} \leq V_{DD} \leq 5.5\text{ V}$	1			μs
		$2.7\text{ V} \leq V_{DD} < 3.3\text{ V}$	3			μs
Reference voltage stabilization wait time	t_{VR}	CVRE: 0 to 1 ^{Note 2}	10			μs

- Notes**
- Time required until a state is entered where the DC and AC specifications of the comparator are satisfied after the operation of the comparator has been enabled (CMPnEN bit = 1; n = 0 to 5)
 - Enable comparator output (CnOE bit = 1; n = 0 to 5) after enabling operation of the internal reference voltage generator (by setting the CVREm bit to 1; m = 0 to 2) and waiting for the operation stabilization time to elapse.

Remark These characteristics apply when AV_{REFP} is selected as the power supply source of the internal reference voltage by using the CVRVS0 bit, and when AV_{REFM} is selected as GND of the internal reference voltage by using the CVRVS1 bit.

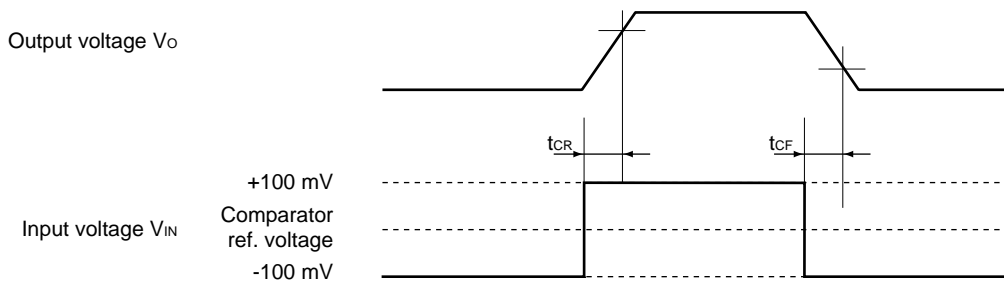

3.6.5 POR circuit characteristics

($T_A = -40$ to $+125^\circ\text{C}$, $V_{SS} = 0\text{ V}$)

Parameter	Symbol	Conditions	MIN.	TYP.	MAX.	Unit
Detection voltage	V_{POR}	Power supply rise time	1.45	1.51	1.62	V
	V_{PDR}	Power supply fall time	1.44	1.50	1.61	V
Minimum pulse width ^{Note}	T_{PW}		300			μs

Note Minimum time required for a POR reset when V_{DD} exceeds below V_{PDR} . This is also the minimum time required for a POR reset from when V_{DD} exceeds below 0.7 V to when V_{DD} exceeds V_{POR} while STOP mode is entered or the main system clock is stopped through setting bit 0 (HISTOP) and bit 7 (MSTOP) in the clock operation status control register (CSC).

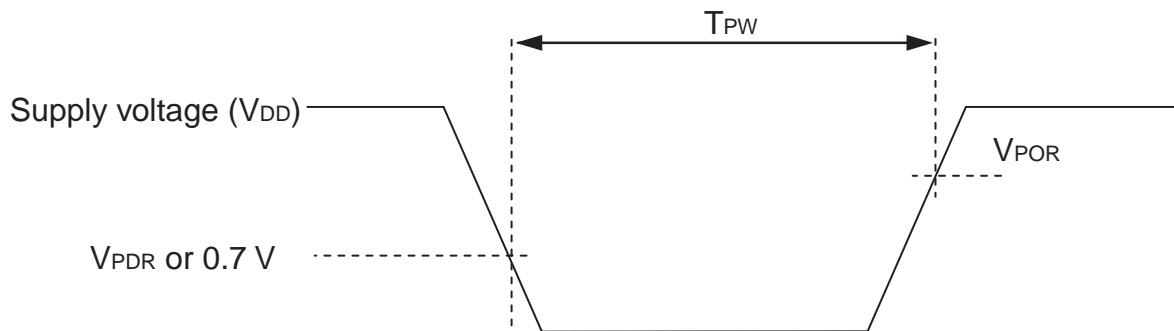

3.6.6 LVD circuit characteristics

LVD Detection Voltage of Reset Mode and Interrupt Mode

($T_A = -40$ to $+125^\circ\text{C}$, $V_{PDR} \leq V_{DD} \leq 5.5\text{ V}$, $V_{SS} = 0\text{ V}$)

Parameter	Symbol	Conditions	MIN.	TYP.	MAX.	Unit	
Detection voltage	V_{LVD0}	Power supply rise time	3.97	4.06	4.25	V	
		Power supply fall time	3.89	3.98	4.15	V	
	V_{LVD1}	Power supply rise time	3.67	3.75	3.93	V	
		Power supply fall time	3.59	3.67	3.83	V	
	V_{LVD2}	Power supply rise time	3.06	3.13	3.28	V	
		Power supply fall time	2.99	3.06	3.20	V	
	V_{LVD3}	Power supply rise time	2.95	3.02	3.17	V	
		Power supply fall time	2.89	2.96	3.09	V	
	V_{LVD4}	Power supply rise time	2.85	2.92	3.07	V	
		Power supply fall time	2.79	2.86	2.99	V	
	V_{LVD5}	Power supply rise time	2.75	2.81	2.95	V	
		Power supply fall time	2.70	2.75	2.88	V	
	Minimum pulse width	t_{LW}		300			μs
	Detection delay time					300	μs

LVD Detection Voltage of Interrupt & Reset Mode

($T_A = -40$ to $+125^\circ\text{C}$, $V_{PDR} \leq V_{DD} \leq 5.5$ V, $V_{SS} = 0$ V)

Parameter	Symbol	Conditions	MIN.	TYP.	MAX.	Unit	
Interrupt and reset mode	V _{LVD0}	$V_{POC2}, V_{POC1}, V_{POC0} = 0, 1, 1$, falling reset voltage: 2.7 V	2.70	2.75	2.88	V	
	V _{LVD1}	LVIS1, LVIS0 = 1, 0	Rising release reset voltage	2.85	2.92	3.07	V
			Falling interrupt voltage	2.79	2.86	2.99	V
	V _{LVD2}	LVIS1, LVIS0 = 0, 1	Rising release reset voltage	2.95	3.02	3.17	V
			Falling interrupt voltage	2.89	2.96	3.09	V
	V _{LVD3}	LVIS1, LVIS0 = 0, 0	Rising release reset voltage	3.97	4.06	4.25	V
Falling interrupt voltage			3.89	3.98	4.15	V	

3.6.7 Supply voltage rise inclination characteristics

($T_A = -40$ to $+125^\circ\text{C}$, $V_{SS} = 0$ V)

Parameter	Symbol	Conditions	MIN.	TYP.	MAX.	Unit
Supply voltage rise	S _{VDD}				54	V/ms

Caution Keep the internal reset status by using the LVD circuit or an external reset signal until V_{DD} rises to within the operating voltage range shown in 33.4 AC Characteristics.

3.7 RAM Data Retention Characteristics

($T_A = -40$ to $+125^\circ\text{C}$, $V_{SS} = 0$ V)

Parameter	Symbol	Conditions	MIN.	TYP.	MAX.	Unit
Data retention supply voltage ^{Note 2}	V _{DDDR}		1.47 ^{Note 1}		5.5	V

Note The value depends on the POR detection voltage. When the voltage drops, the RAM data is retained before a POR reset is effected, but RAM data is not retained when a POR reset is effected.

Caution When CPU is operated at the voltage of out of the operation voltage range, RAM data is not retained. Therefore, set STOP mode before the supplied voltage is below the operation voltage range.

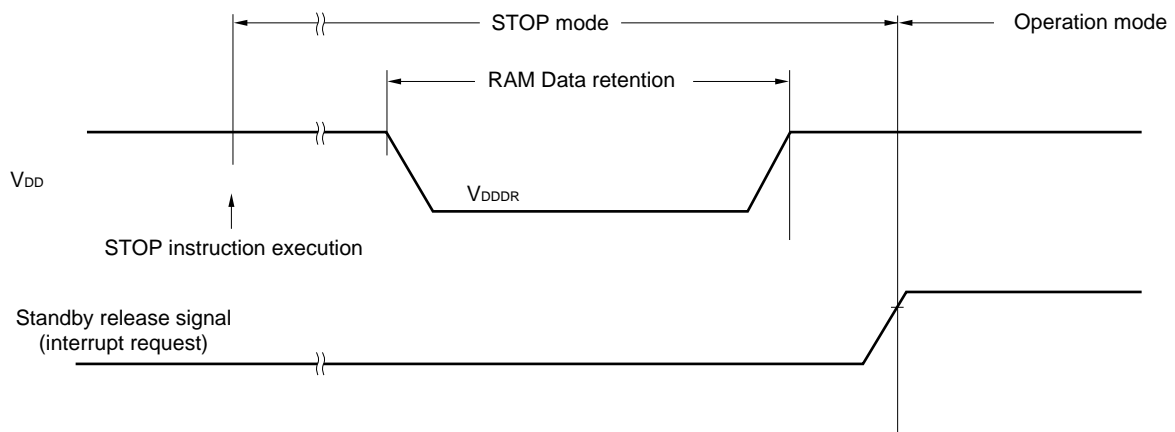

3.8 Flash Memory Programming Characteristics

($T_A = -40$ to $+105^\circ\text{C}$, $2.7\text{ V} \leq V_{DD} \leq 5.5\text{ V}$, $V_{SS} = 0\text{ V}$)

Parameter	Symbol	Conditions	MIN.	TYP.	MAX.	Unit
CPU/peripheral hardware clock frequency	f_{CLK}	$2.7\text{ V} \leq V_{DD} \leq 5.5\text{ V}$	1		32	MHz
Number of code flash rewrites ^{Notes 1, 2, 3}	C_{erwr}	Retained for 20 years, $T_A = 85^\circ\text{C}$ ^{Note 3, 4}	1,000			Times
Number of data flash rewrites ^{Notes 1, 2, 3}		Retained for 1 year, $T_A = 25^\circ\text{C}$ ^{Note 3, 4}		1,000,000		
		Retained for 5 years, $T_A = 85^\circ\text{C}$ ^{Note 3, 4}	100,000			
		Retained for 20 years, $T_A = 85^\circ\text{C}$ ^{Note 3, 4}	10,000			

- Notes**
- 1 erase + 1 write after the erase is regarded as 1 rewrite. The retaining years are until next rewrite after the rewrite.
 2. When using flash memory programmer and Renesas Electronics self programming library
 3. These are the characteristics of the flash memory and the results obtained from reliability testing by Renesas Electronics Corporation.
 4. These are the average temperature of during the retainment.

3.9 Dedicated Flash Memory Programmer Communication (UART)

($T_A = -40$ to $+105^\circ\text{C}$, $2.7\text{ V} \leq V_{DD} \leq 5.5\text{ V}$, $V_{SS} = 0\text{ V}$)

Parameter	Symbol	Conditions	MIN.	TYP.	MAX.	Unit
Transfer rate		During serial programming	115.2 k		1 M	bps

3.10 Timing of Entry to Flash Memory Programming Modes

($T_A = -40$ to $+125^\circ\text{C}$, $2.7\text{ V} \leq V_{DD} \leq 5.5\text{ V}$, $V_{SS} = 0\text{ V}$)

Parameter	Symbol	Conditions	MIN.	TYP.	MAX.	Unit
How long from when an external reset ends until the initial communication settings are specified	t_{SUIINIT}	POR and LVD reset must end before the external reset ends.			100	ms
How long from when the TOOL0 pin is placed at the low level until an external reset ends	t_{SU}	POR and LVD reset must end before the external reset ends.	10			μs
How long the TOOL0 pin must be kept at the low level after a reset ends (except soft processing time)	t_{HD}	POR and LVD reset must end before the external reset ends.	1			ms

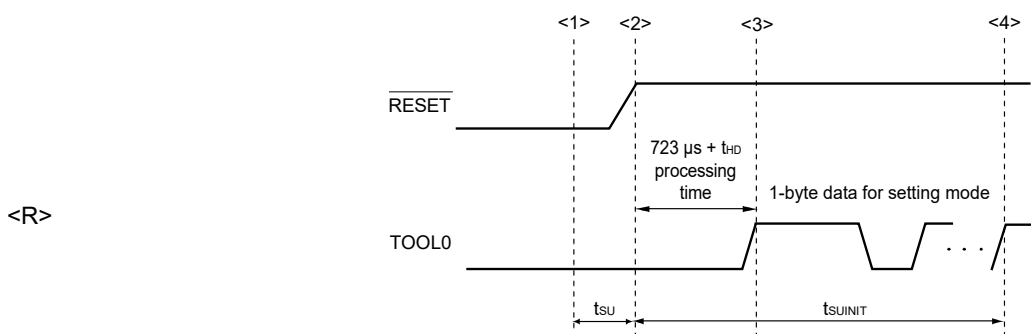

- <1> The low level is input to the TOOL0 pin.
- <2> The external reset ends (POR and LVD reset must end before the pin reset ends.).
- <3> The TOOL0 pin is set to the high level.
- <4> Complete the baud rate setting by UART reception.

Remark t_{SUIINIT} : The segment shows that it is necessary to finish specifying the initial communication settings within 100 ms from when the resets end.

t_{SU} : How long from when the TOOL0 pin is placed at the low level until an external reset ends

t_{HD} : How long to keep the TOOL0 pin at the low level from when the external and internal resets end (except soft processing time)

4. PACKAGE DRAWINGS

<R> 4.1 20-pin Products

R5F1076CGSP#V0, R5F1076CGSP#X0, R5F1076CMSP#V0, R5F1076CMSP#X0

JEITA Package Code	RENESAS Code	Previous Code	MASS (TYP.) [g]
P-LSSOP20-4.4x6.5-0.65	PLSP0020JB-A	P20MA-65-NAA-1	0.1

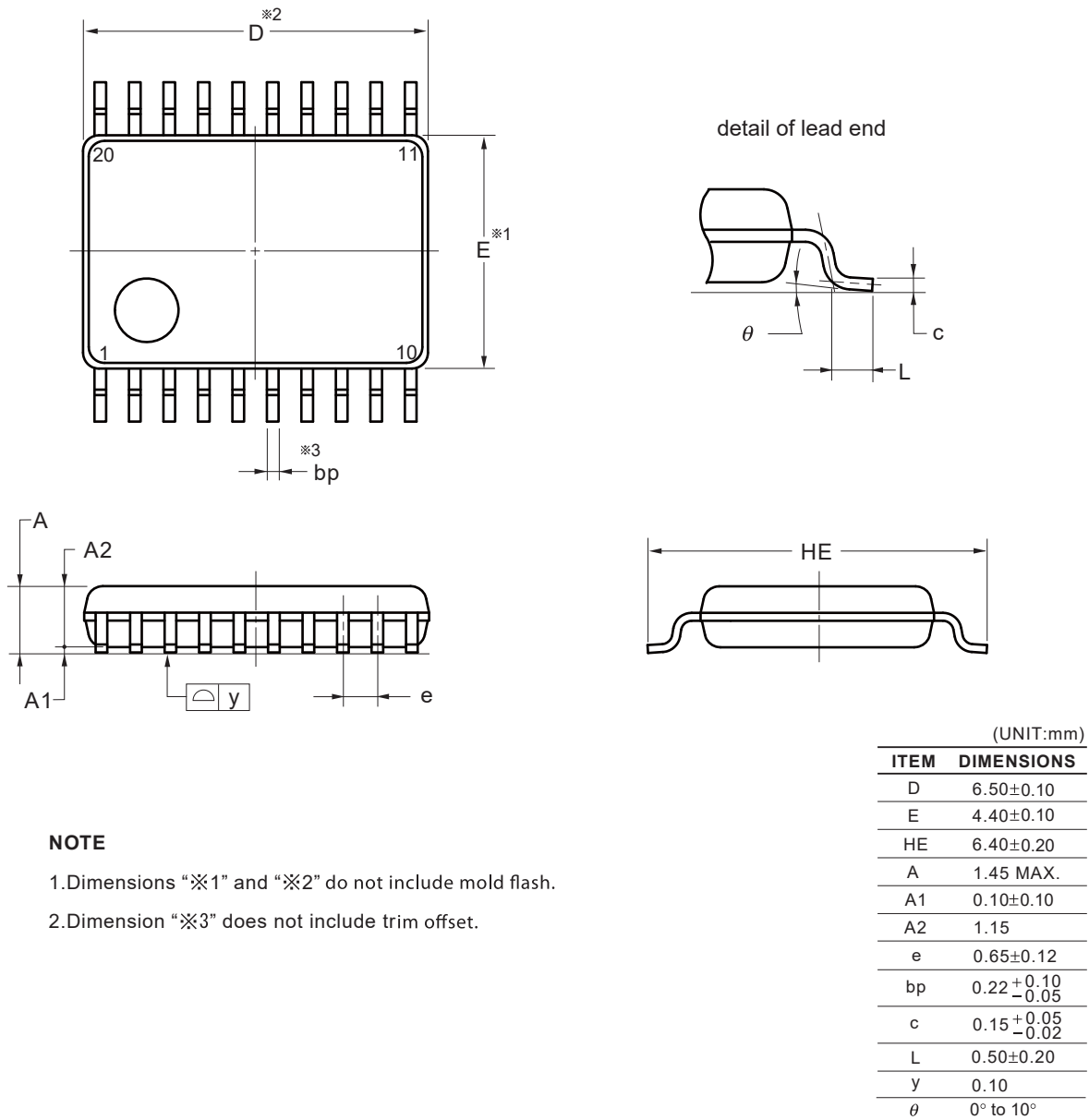

NOTE

1. Dimensions "※1" and "※2" do not include mold flash.
2. Dimension "※3" does not include trim offset.

©2012 Renesas Electronics Corporation. All rights reserved.

4.2 30-pin Products

R5F107ACGSP#V0, R5F107AEGSP#V0, R5F107ACGSP#X0, R5F107AEGSP#X0, R5F107ACMSP#V0, R5F107AEMSP#V0, R5F107ACMSP#X0, R5F107AEMSP#X0

JEITA Package Code	RENESAS Code	Previous Code	MASS (TYP.) [g]
P-LSSOP30-0300-0.65	PLSP0030JB-B	S30MC-65-5A4-3	0.18

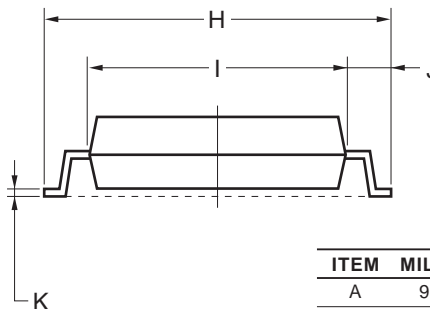
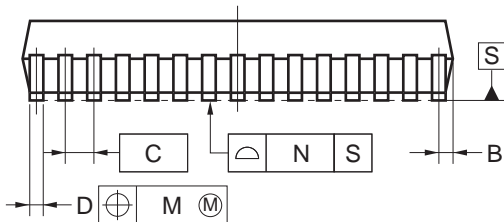
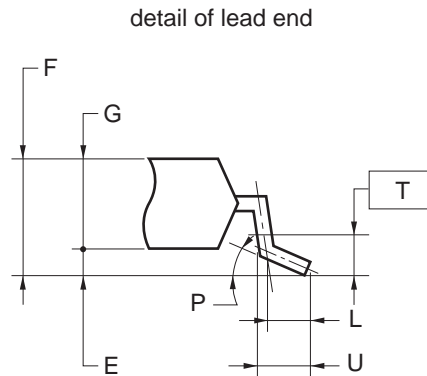
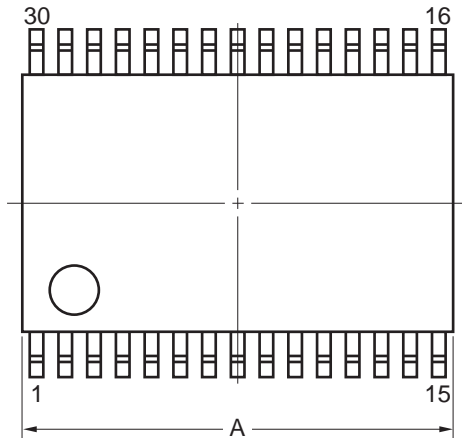

NOTE
Each lead centerline is located within 0.13 mm of its true position (T.P.) at maximum material condition.

ITEM	MILLIMETERS
A	9.85±0.15
B	0.45 MAX.
C	0.65 (T.P.)
D	0.24 ^{+0.08} _{-0.07}
E	0.1±0.05
F	1.3±0.1
G	1.2
H	8.1±0.2
I	6.1±0.2
J	1.0±0.2
K	0.17±0.03
L	0.5
M	0.13
N	0.10
P	3° ^{+5°} _{-3°}
T	0.25
U	0.6±0.15

4.3 38-pin Products

R5F107DEGSP#V0, R5F107DEGSP#X0, R5F107DEMSP#V0, R5F107DEMSP#X0

JEITA Package Code	RENESAS Code	Previous Code	MASS (TYP.) [g]
P-SSOP38-0300-0.65	PRSP0038JA-A	P38MC-65-2A4-2	0.3

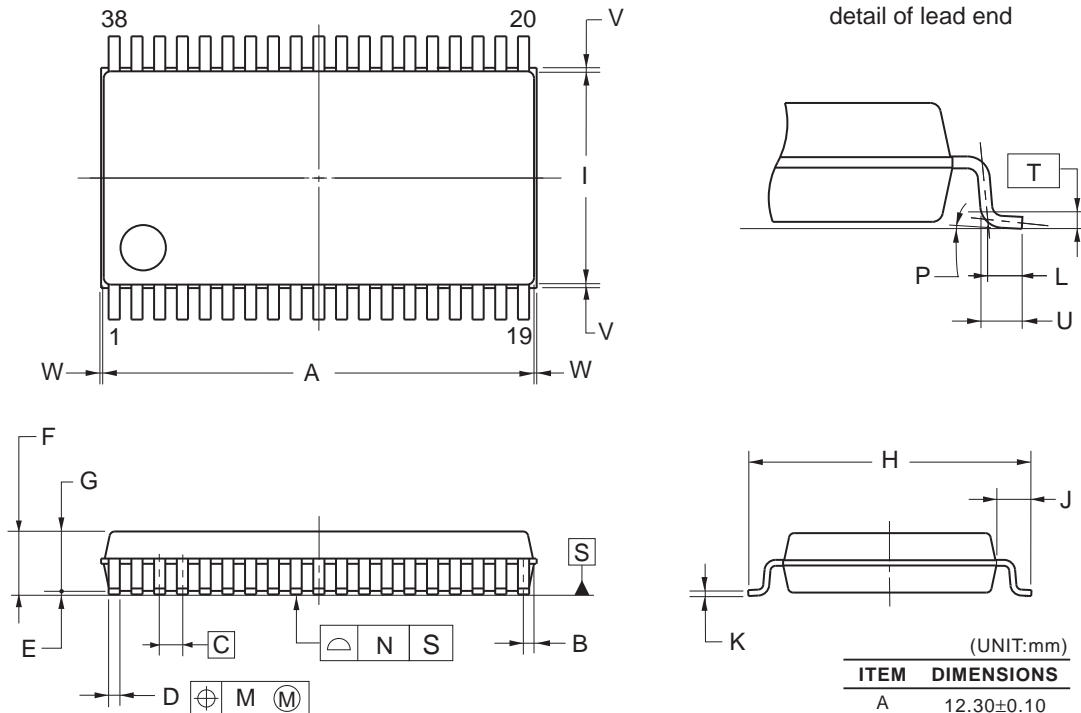

NOTE

Each lead centerline is located within 0.10 mm of its true position (T.P.) at maximum material condition.

(UNIT:mm)

ITEM	DIMENSIONS
A	12.30±0.10
B	0.30
C	0.65 (T.P.)
D	0.32 ^{+0.08} _{-0.07}
E	0.125±0.075
F	2.00 MAX.
G	1.70±0.10
H	8.10±0.20
I	6.10±0.10
J	1.00±0.20
K	0.17 ^{+0.08} _{-0.07}
L	0.50
M	0.10
N	0.10
P	3° ^{+7°} _{-3°}
T	0.25(T.P.)
U	0.60±0.15
V	0.25 MAX.
W	0.15 MAX.

Revision History	RL78/I1A Datasheet
-------------------------	---------------------------

Rev.	Date	Description	
		Page	Summary
3.20	Sep 29, 2017	p.1	Modification of description in 1.1 Features
		p.59	Modification of figure in 2.10 Timing of Entry to Flash Memory Programming Modes
		p.102	Modification of figure in 3.10 Timing of Entry to Flash Memory Programming Modes
		p.103	Modification of figure in 4.1 20-pin Products

All trademarks and registered trademarks are the property of their respective owners.

SuperFlash is a registered trademark of Silicon Storage Technology, Inc. in several countries including the United States and Japan.

Caution: This product uses SuperFlash® technology licensed from Silicon Storage Technology, Inc.
--

NOTES FOR CMOS DEVICES

- (1) **VOLTAGE APPLICATION WAVEFORM AT INPUT PIN:** Waveform distortion due to input noise or a reflected wave may cause malfunction. If the input of the CMOS device stays in the area between VIL (MAX) and VIH (MIN) due to noise, etc., the device may malfunction. Take care to prevent chattering noise from entering the device when the input level is fixed, and also in the transition period when the input level passes through the area between VIL (MAX) and VIH (MIN).
- (2) **HANDLING OF UNUSED INPUT PINS:** Unconnected CMOS device inputs can be cause of malfunction. If an input pin is unconnected, it is possible that an internal input level may be generated due to noise, etc., causing malfunction. CMOS devices behave differently than Bipolar or NMOS devices. Input levels of CMOS devices must be fixed high or low by using pull-up or pull-down circuitry. Each unused pin should be connected to VDD or GND via a resistor if there is a possibility that it will be an output pin. All handling related to unused pins must be judged separately for each device and according to related specifications governing the device.
- (3) **PRECAUTION AGAINST ESD:** A strong electric field, when exposed to a MOS device, can cause destruction of the gate oxide and ultimately degrade the device operation. Steps must be taken to stop generation of static electricity as much as possible, and quickly dissipate it when it has occurred. Environmental control must be adequate. When it is dry, a humidifier should be used. It is recommended to avoid using insulators that easily build up static electricity. Semiconductor devices must be stored and transported in an anti-static container, static shielding bag or conductive material. All test and measurement tools including work benches and floors should be grounded. The operator should be grounded using a wrist strap. Semiconductor devices must not be touched with bare hands. Similar precautions need to be taken for PW boards with mounted semiconductor devices.
- (4) **STATUS BEFORE INITIALIZATION:** Power-on does not necessarily define the initial status of a MOS device. Immediately after the power source is turned ON, devices with reset functions have not yet been initialized. Hence, power-on does not guarantee output pin levels, I/O settings or contents of registers. A device is not initialized until the reset signal is received. A reset operation must be executed immediately after power-on for devices with reset functions.
- (5) **POWER ON/OFF SEQUENCE:** In the case of a device that uses different power supplies for the internal operation and external interface, as a rule, switch on the external power supply after switching on the internal power supply. When switching the power supply off, as a rule, switch off the external power supply and then the internal power supply. Use of the reverse power on/off sequences may result in the application of an overvoltage to the internal elements of the device, causing malfunction and degradation of internal elements due to the passage of an abnormal current. The correct power on/off sequence must be judged separately for each device and according to related specifications governing the device.
- (6) **INPUT OF SIGNAL DURING POWER OFF STATE :** Do not input signals or an I/O pull-up power supply while the device is not powered. The current injection that results from input of such a signal or I/O pull-up power supply may cause malfunction and the abnormal current that passes in the device at this time may cause degradation of internal elements. Input of signals during the power off state must be judged separately for each device and according to related specifications governing the device.

Notice

1. Descriptions of circuits, software and other related information in this document are provided only to illustrate the operation of semiconductor products and application examples. You are fully responsible for the incorporation or any other use of the circuits, software, and information in the design of your product or system. Renesas Electronics disclaims any and all liability for any losses and damages incurred by you or third parties arising from the use of these circuits, software, or information.
2. Renesas Electronics hereby expressly disclaims any warranties against and liability for infringement or any other disputes involving patents, copyrights, or other intellectual property rights of third parties, by or arising from the use of Renesas Electronics products or technical information described in this document, including but not limited to, the product data, drawing, chart, program, algorithm, application examples.
3. No license, express, implied or otherwise, is granted hereby under any patents, copyrights or other intellectual property rights of Renesas Electronics or others.
4. You shall not alter, modify, copy, or otherwise misappropriate any Renesas Electronics product, whether in whole or in part. Renesas Electronics disclaims any and all liability for any losses or damages incurred by you or third parties arising from such alteration, modification, copy or otherwise misappropriation of Renesas Electronics products.
5. Renesas Electronics products are classified according to the following two quality grades: "Standard" and "High Quality". The intended applications for each Renesas Electronics product depends on the product's quality grade, as indicated below.
"Standard": Computers; office equipment; communications equipment; test and measurement equipment; audio and visual equipment; home electronic appliances; machine tools; personal electronic equipment; and industrial robots etc.
"High Quality": Transportation equipment (automobiles, trains, ships, etc.); traffic control (traffic lights); large-scale communication equipment; key financial terminal systems; safety control equipment; etc.
Renesas Electronics products are neither intended nor authorized for use in products or systems that may pose a direct threat to human life or bodily injury (artificial life support devices or systems, surgical implantations etc.), or may cause serious property damages (space and undersea repeaters; nuclear power control systems; aircraft control systems; key plant systems; military equipment; etc.). Renesas Electronics disclaims any and all liability for any damages or losses incurred by you or third parties arising from the use of any Renesas Electronics product for which the product is not intended by Renesas Electronics.
6. When using the Renesas Electronics products, refer to the latest product information (data sheets, user's manuals, application notes, "General Notes for Handling and Using Semiconductor Devices" in the reliability handbook, etc.), and ensure that usage conditions are within the ranges specified by Renesas Electronics with respect to maximum ratings, operating power supply voltage range, heat radiation characteristics, installation, etc. Renesas Electronics disclaims any and all liability for any malfunctions or failure or accident arising out of the use of Renesas Electronics products beyond such specified ranges.
7. Although Renesas Electronics endeavors to improve the quality and reliability of Renesas Electronics products, semiconductor products have specific characteristics such as the occurrence of failure at a certain rate and malfunctions under certain use conditions. Further, Renesas Electronics products are not subject to radiation resistance design. Please ensure to implement safety measures to guard them against the possibility of bodily injury, injury or damage caused by fire, and social damage in the event of failure or malfunction of Renesas Electronics products, such as safety design for hardware and software including but not limited to redundancy, fire control and malfunction prevention, appropriate treatment for aging degradation or any other appropriate measures by your own responsibility as warranty for your products/system. Because the evaluation of microcomputer software alone is very difficult and not practical, please evaluate the safety of the final products or systems manufactured by you.
8. Please contact a Renesas Electronics sales office for details as to environmental matters such as the environmental compatibility of each Renesas Electronics product. Please investigate applicable laws and regulations that regulate the inclusion or use of controlled substances, including without limitation, the EU RoHS Directive carefully and sufficiently and use Renesas Electronics products in compliance with all these applicable laws and regulations. Renesas Electronics disclaims any and all liability for damages or losses occurring as a result of your noncompliance with applicable laws and regulations.
9. Renesas Electronics products and technologies shall not be used for or incorporated into any products or systems whose manufacture, use, or sale is prohibited under any applicable domestic or foreign laws or regulations. You shall not use Renesas Electronics products or technologies for (1) any purpose relating to the development, design, manufacture, use, stockpiling, etc., of weapons of mass destruction, such as nuclear weapons, chemical weapons, or biological weapons, or missiles (including unmanned aerial vehicles (UAVs)) for delivering such weapons, (2) any purpose relating to the development, design, manufacture, or use of conventional weapons, or (3) any other purpose of disturbing international peace and security, and you shall not sell, export, lease, transfer, or release Renesas Electronics products or technologies to any third party whether directly or indirectly with knowledge or reason to know that the third party or any other party will engage in the activities described above. When exporting, selling, transferring, etc., Renesas Electronics products or technologies, you shall comply with any applicable export control laws and regulations promulgated and administered by the governments of the countries asserting jurisdiction over the parties or transactions.
10. Please acknowledge and agree that you shall bear all the losses and damages which are incurred from the misuse or violation of the terms and conditions described in this document, including this notice, and hold Renesas Electronics harmless, if such misuse or violation results from your resale or making Renesas Electronics products available any third party.
11. This document shall not be reprinted, reproduced or duplicated in any form, in whole or in part, without prior written consent of Renesas Electronics.
12. Please contact a Renesas Electronics sales office if you have any questions regarding the information contained in this document or Renesas Electronics products.
(Note 1) "Renesas Electronics" as used in this document means Renesas Electronics Corporation and also includes its majority-owned subsidiaries.
(Note 2) "Renesas Electronics product(s)" means any product developed or manufactured by or for Renesas Electronics.

(Rev.3.0-1 November 2016)



SALES OFFICES

Renesas Electronics Corporation

<http://www.renesas.com>

Refer to "<http://www.renesas.com/>" for the latest and detailed information.

Renesas Electronics America Inc.

2801 Scott Boulevard Santa Clara, CA 95050-2549, U.S.A.
Tel: +1-408-588-6000, Fax: +1-408-588-6130

Renesas Electronics Canada Limited

9251 Yonge Street, Suite 8309 Richmond Hill, Ontario Canada L4C 9T3
Tel: +1-905-237-2004

Renesas Electronics Europe Limited

Dukes Meadow, Millboard Road, Bourne End, Buckinghamshire, SL8 5FH, U.K.
Tel: +44-1628-585-100, Fax: +44-1628-585-900

Renesas Electronics Europe GmbH

Arcadiastrasse 10, 40472 Düsseldorf, Germany
Tel: +49-211-6503-0, Fax: +49-211-6503-1327

Renesas Electronics (China) Co., Ltd.

Room 1709, Quantum Plaza, No.27 ZhiChunLu Haidian District, Beijing 100191, P.R.China
Tel: +86-10-8235-1155, Fax: +86-10-8235-7679

Renesas Electronics (Shanghai) Co., Ltd.

Unit 301, Tower A, Central Towers, 555 Langao Road, Putuo District, Shanghai, P. R. China 200333
Tel: +86-21-2226-0888, Fax: +86-21-2226-0999

Renesas Electronics Hong Kong Limited

Unit 1601-1611, 16/F., Tower 2, Grand Century Place, 193 Prince Edward Road West, Mongkok, Kowloon, Hong Kong
Tel: +852-2265-6688, Fax: +852-2886-9022

Renesas Electronics Taiwan Co., Ltd.

13F, No. 363, Fu Shing North Road, Taipei 10543, Taiwan
Tel: +886-2-8175-9600, Fax: +886-2-8175-9670

Renesas Electronics Singapore Pte. Ltd.

80 Bendemeer Road, Unit #06-02 Hyflux Innovation Centre, Singapore 339949
Tel: +65-6213-0200, Fax: +65-6213-0300

Renesas Electronics Malaysia Sdn.Bhd.

Unit 1207, Block B, Menara Amcorp, Amcorp Trade Centre, No. 18, Jln Persiaran Barat, 46050 Petaling Jaya, Selangor Darul Ehsan, Malaysia
Tel: +60-3-7955-9390, Fax: +60-3-7955-9510

Renesas Electronics India Pvt. Ltd.

No.777C, 100 Feet Road, HAL II Stage, Indiranagar, Bangalore, India
Tel: +91-80-67208700, Fax: +91-80-67208777

Renesas Electronics Korea Co., Ltd.

12F., 234 Teheran-ro, Gangnam-Gu, Seoul, 135-080, Korea
Tel: +82-2-558-3737, Fax: +82-2-558-5141