

SOREDE

索 瑞 達 電 子

深圳市索瑞达电子有限公司

承 认 书

SPECIFICATION FOR APPROVAL

客户名称:

Customer Name : _____

客户料号:

Customer P/N: _____

产品名称:

功率电感

Product Name: _____

索瑞达料号:

SNR.8065.TYD220MT00

Sorede P/N: _____

制造厂商 Manufacturer	
拟制 Draft	黄小香
审核 Check	符妃团 工程专用章
日期 Date	2020-09-23

客户承认印章 Approval Signet	
日期 Date	

地址:深圳市观澜镇福城街道新塘村8号源创园陆号A6栋3楼.

Address:3Rd Floor, Building A6, Yuanchuangyuanlu, No. 8 Xintang Village,
Fucheng Street, Guanlan Town, Shenzhen.

电话 Tel: 0755-29803356 传真 Fax: 0755-29803506

电子邮件 E-mail: sorde@vip.163.com

网址 http:// www.szsorede.com

文件编号 File Number	SRD-WI-12366	版本号 Version Number	A	页码 page	1/7
---------------------	--------------	-----------------------	---	------------	-----

1、外形尺寸 Dimension :

单位Unit: mm

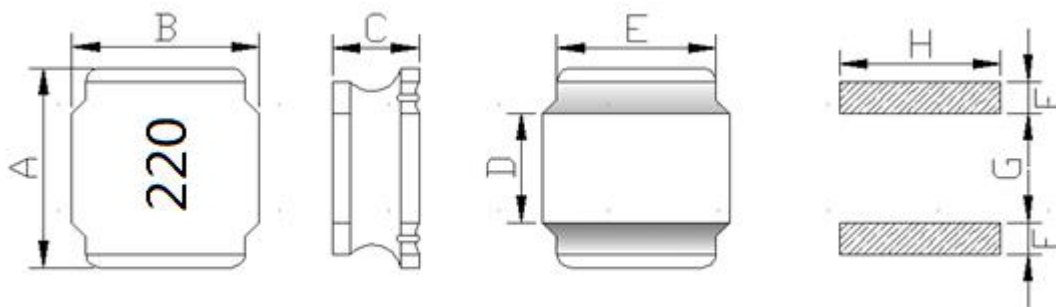

A	8.00±0.3
B	8.00±0.3
C	6.5Max.
D	5.6Ref
E	6.3Ref
F	2.5Ref
G	3.4Ref
H	7.5Ref

2、产品品名构成 Product Spec. Model

SNR 8065 T Y D 220 M T 00
a b c d e f g h i

a: 系列名称Series name

b: 产品尺寸Product dimensions (A x B x C)

c: 形状Shape (T:12边形12-Sided、B:8边形8-Sided、S:4边形4-Sided)

d: 密封方式Sealing way (L: 冷封Cold seal Y: 热封Heat seal)

e: 印字方向 Lettering direction ▶

f: 电感值Inductance Value

(1R0:1.0uH; 100: 10uH; 101:100uH)

g:电感公差Inductance Tolerance (K:10% ; M:20% ; N:30%)

h: 包装Package(T:磁带/卷轴Tape/Reel、B: 散装Bulk)

i: 编号Numbering (标准standard)

▶ Lettering direction

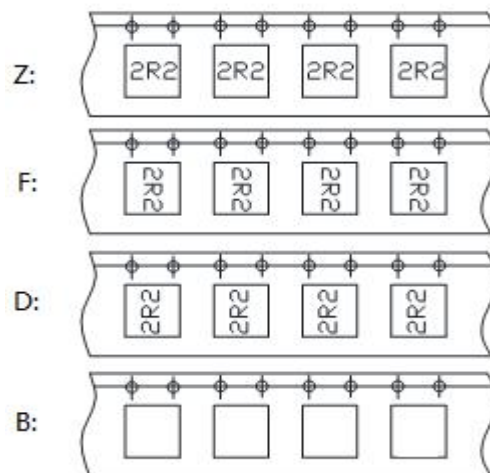

3、结构Structure

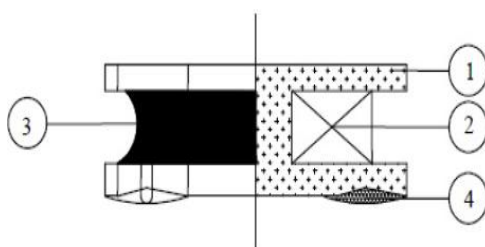

4、材料清单MATERIAL LIST

NO.	PARTS	MATERIAL SPECIFICATIONS	UL FILE NO.	TEMP. CLASS
1	CORE	N401HSDR-8.0-6.3-4.0-3.7S-P4 OR EQUIVALENT	NA	NA
2	WIRE	G1 P180 OR EQUIVALENT	E258243	180°C
3	ADHESIVE	E-500AH (胶水) + FSC4(合金粉) OR EQUIVALENT	NA	NA
4	SOLDER	Sn99.3-Cu0.7 OR EQUIVALENT	NA	NA

*NA:NOT APPLICABLE.

5、电性能参数表 Electrical Characteristics List

规格型号 Part NO.	电感量 Tolerance(μ H)	测试频率 Test Freq. (kHz/v)	直流电阻 DCR Max ($m\Omega$)	饱和电流 Isat (A)	线径WIRE (ϕ /mm)	圈数TS (Ref)
SNR.8065.TYD220MT00	22	100/0.25	82	4.00	0.38	22.5

※公差Tolerance: N:±30%、M:±20%、K:±10%。
 ※工作温度Operating temperature rang: -40 °C to +125°C (Including Self-heating)
 ※储存温度Storage temperature rang: -40 °C to +125°C

Isat电流: 指使电感量比初始值下降30% (The rated DC current is that which cause at 30% inductance reduction from the initial value) 。

文件编号 File Number	SRD-WI-12366	版本号 Version Number	A	页码 page	3/7
---------------------	--------------	-----------------------	---	------------	-----

1) 特性测试数据

CUSTOMER		FCSM2252		QUANTITY	5PCS	
ODESCRIPTION		SNR. 8065. TYD220MT00		DATE	2020/9/23	
ITEM	LOA (uH)	4.0A (uH)	DCR(mΩ)	Dimension		
SPEC	22uH±20%	≥0A×70%	82Max.	A(mm)	B(mm)	C(mm)
	100KHZ/0.25V			8.0±0.3	8.0±0.3	6.5Max.
1	22.90	18.70	67.2	8.12	8.09	6.42
2	22.60	18.80	65.8	8.10	8.11	6.41
3	23.00	18.90	65.4	8.13	8.10	6.42
4	22.60	18.40	66.3	8.11	8.11	6.40
5	23.20	18.90	66.4	8.12	8.10	6.43
Average	22.86	18.74	66.22	8.12	8.10	6.42
R	0.60	0.50	1.80	0.03	0.02	0.03

2) ISAT曲线图

SNR.8065.TYD220MT00			
TIME(秒)	Isat(A)	L(uH)	$\Delta L/L(\%)$
1.00	0.00	23.00	0.00%
1.00	0.50	23.00	0.00%
1.00	1.00	22.90	-0.43%
1.00	1.50	22.70	-1.30%
1.00	2.00	22.50	-2.17%
1.00	2.50	22.20	-3.48%
1.00	3.00	21.60	-6.09%
1.00	3.50	20.50	-10.87%
1.00	4.00	18.60	-19.13%
1.00	4.60	14.90	-35.22%

※DC bias current characteristics in the ambient temperature 25°C
Frequency 100KHz/0.25V

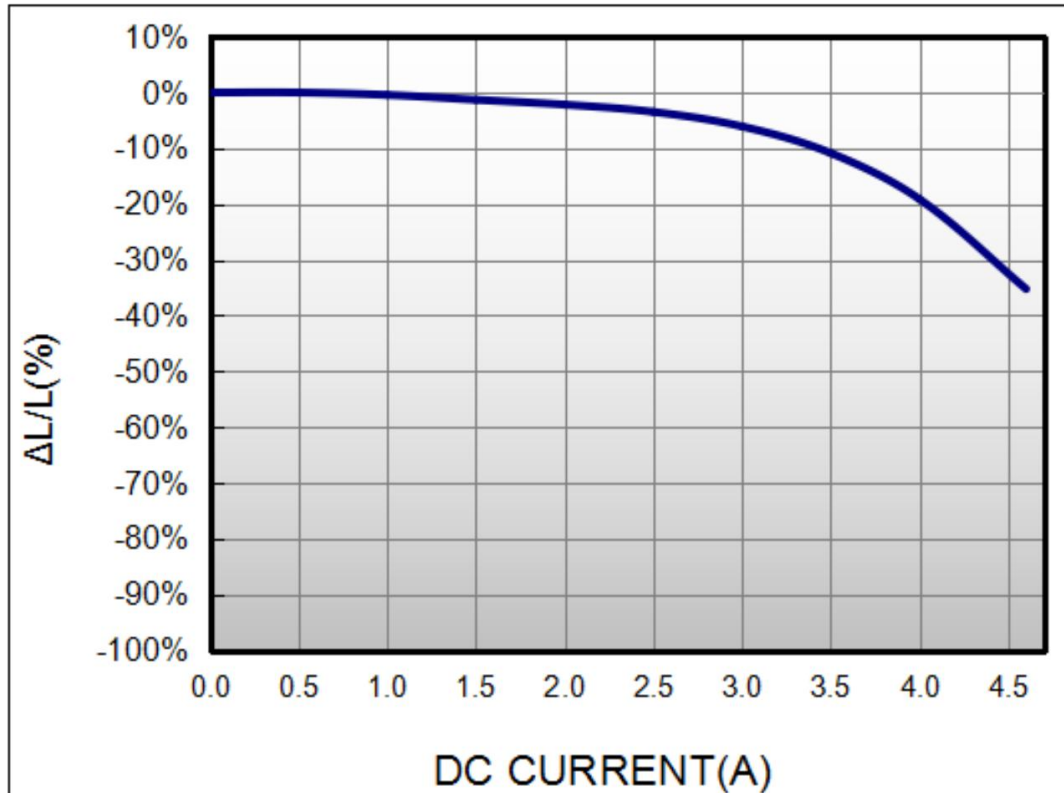

3) 频率曲线图

SNR.8065.TYD220MT00		
FREQ.(KHz)	L(uH)	$\Delta L/L(\%)$
100	22.90	0.00%
200	22.70	-0.87%
300	22.70	-0.87%
400	22.60	-1.31%
500	22.50	-1.75%
600	22.30	-2.62%
700	22.30	-2.62%
800	22.20	-3.06%
900	22.10	-3.49%
1000	22.10	-3.49%

※DC bias current characteristics in the ambient temperature 25°C

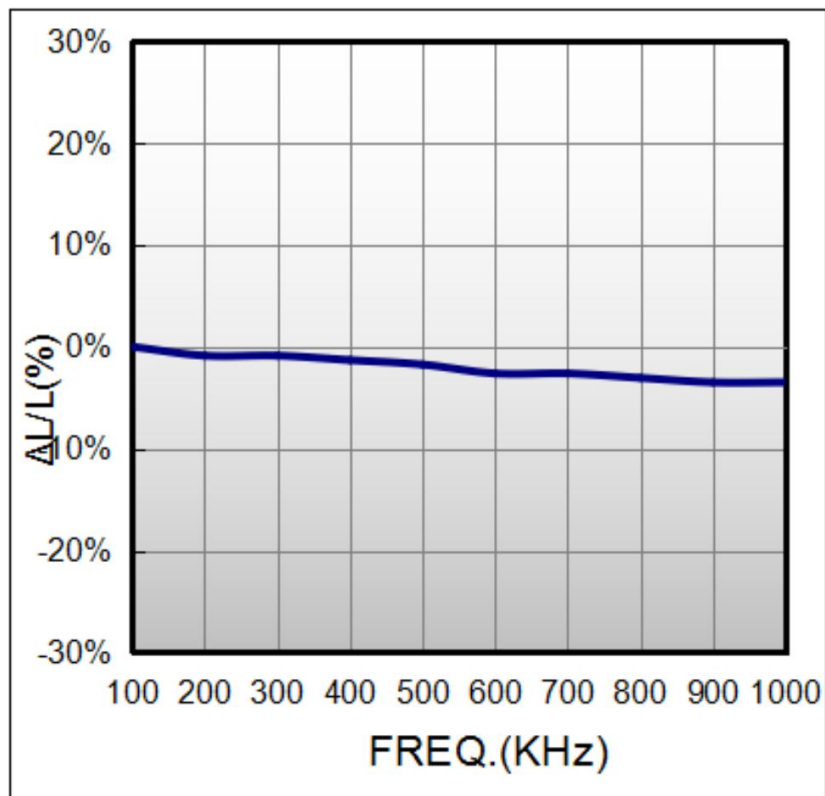

6、产品包装 Packaging

1) 载带包装示意图 Tape packing diagram

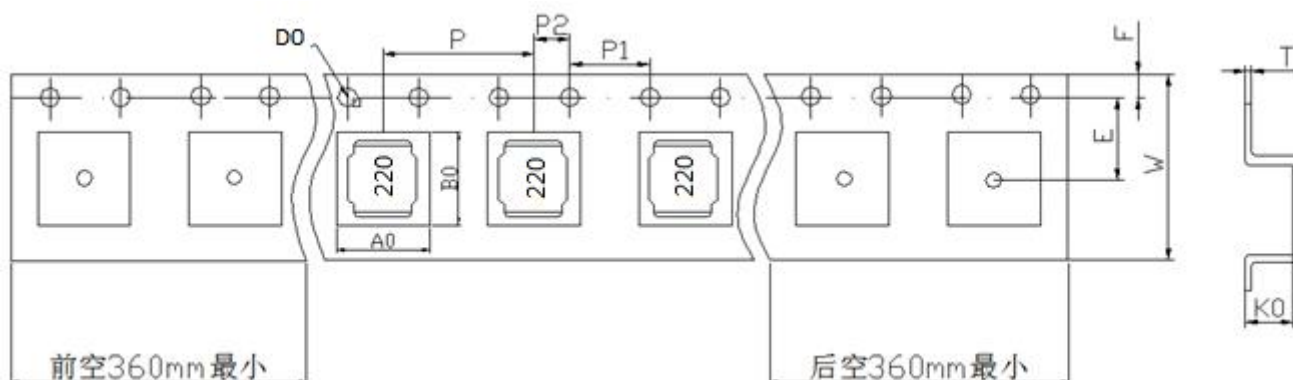

ITEM	W	A0	B0	K0	P	E	F	D0	P0	P2	T
DIM	16.00	8.4	8.4	6.7	12.00	7.5	1.75	1.50	4.00	2.00	0.35
TOLE	±0.3	±0.1	±0.1	±0.1	±0.1	±0.1	±0.1	+0.1	±0.1	±0.1	±0.05

2) 卷盘包装示意图 Tape packing diagram

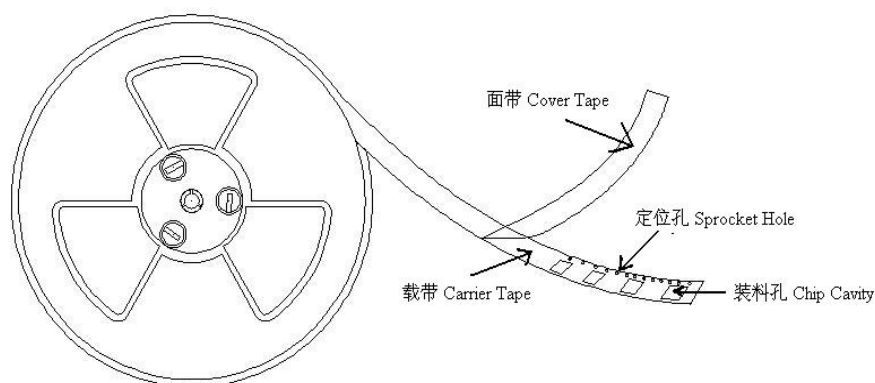

3) 剥离强度要求 Peeling required

- ① F 力大小: 20~100g;
- ② 面带剥离角度: 165°~180°。

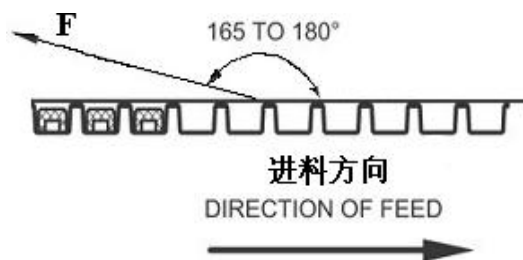

4) 包装数量 Packing quantity

项目 (Project)	数量 (PCS)	尺寸规格 (Size:mm)
盘(Reel)	800	13"
内盒 (Inner box)	2400	340mm*340mm*65mm
外箱 (Out box)	4800	360mm*360mm*160mm

文件编号 File Number	SRD-WI-12366	版本号 Version Number	A	页码 page	7/7
---------------------	--------------	-----------------------	---	------------	-----

7、注意事项 Note

①本承认书保证我司产品作为一个单体时的质量情况。当我司产品被安装到贵司产品上时，请保证贵司的产品已根据贵司的规范进行了有效评估和确认。

This product specification guarantees the quality of our product as a single unit. Please make sure that your product is evaluated and confirmed against your specifications when our product is mounted to your product.

②如果贵司对我司产品的使用已超过了本承认书所界定的产品功能，那么对于由此引发的失效，我司将不予保证。

We cannot warrant against failure caused by any use of our product that deviates from the intended use as described in this product specification.

③为了保持终端电极的焊接性，并使包装材料保持良好状态，必须控制储存区的温度和湿度。

To maintain the solderability of terminal electrodes and to keep the packing material in good condition, temperature and humidity in the storage area should be controlled.

※建议的条件：-10 ~ +40℃，30~70%RH。

Recommended conditions: -10 ~ +40℃，30~70%RH.

※储存超过六个月的，应在实际使用前进行焊接检验。

In case of storage over 6 months, solderability shall be checked before actual usage.

※即使在理想的储存条件下，产品的可焊性也随着时间的推移而降低。因此，产品应从交货时算起，建议8个月之内使用完。

Even under ideal storage conditions, the weldability of the product decreases over time.

therefore, the product should be From the time of delivery, it is recommended that it be used within 8 months.

④本承认书在客户收到30天之内，必须签章返回，逾期视为默认。

The Specification Approval should be sent back to the supplier with customer's chop on it within 30 days after receiving it, or we will take it as approved by customer's automatically.

⑤如有特殊规格要求，请事前联络我司技术部人员。

In case of special specifications please contact our technical department prior staff.