

SOT-723 Plastic-Encapsulate Transistors

MMBT3904M TRANSISTOR (NPN)

FEATURE

- Complementary to MMBT3906M
- Small Package

MARKING: 1N

MAXIMUM RATINGS (T_a=25°C unless otherwise noted)

Symbol	Parameter	Value	Unit
V _{CB0}	Collector-Base Voltage	60	V
V _{CE0}	Collector-Emitter Voltage	40	V
V _{EB0}	Emitter-Base Voltage	6	V
I _c	Collector Current -Continuous	0.2	A
P _c	Power Dissipation	0.1	W
R _{θJA}	Thermal Resistance from Junction to Ambient	1250	°C/W
T _J , T _{stg}	Operation Junction and Storage Temperature Range	-55~+150	°C

SOT-723

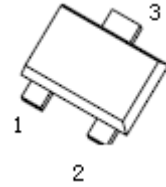

1. BASE
2. EMITTER
3. COLLECTOR

ELECTRICAL CHARACTERISTICS (T_a=25°C unless otherwise specified)

Parameter	Symbol	Test conditions	Min	Typ	Max	Unit
Collector-base breakdown voltage	V _{(BR)CBO}	I _c =10μA, I _E =0	60			V
Collector-emitter breakdown voltage	V _{(BR)CEO}	I _c =1mA, I _B =0	40			V
Emitter-base breakdown voltage	V _{(BR)EBO}	I _E =10μA, I _c =0	6			V
Collector cut-off current	I _{CEX}	V _{CE} =30V, V _{EB(off)} =3V			50	nA
Emitter cut-off current	I _{EBO}	V _{EB} =5V, I _c =0			100	nA
DC current gain	h _{FE(1)}	V _{CE} =1V, I _c =0.1mA	40			
	h _{FE(2)}	V _{CE} =1V, I _c =1mA	70			
	h _{FE(3)}	V _{CE} =1V, I _c =10mA	100		300	
	h _{FE(4)}	V _{CE} =1V, I _c =50mA	60			
Collector-emitter saturation voltage	V _{CE(sat)1}	I _c =10mA, I _B =1mA			0.2	V
	V _{CE(sat)2}	I _c =50mA, I _B =5mA			0.3	V
Base-emitter saturation voltage	V _{BE(sat)1}	I _c =10mA, I _B =1mA	0.65		0.85	V
	V _{BE(sat)2}	I _c =50mA, I _B =5mA			0.95	V
Transition frequency	f _T	V _{CE} =20V, I _c =10mA, f=100MHz	300			MHz
Output capacitance	C _{ob}	V _{CB} =5V, I _E =0, f=1MHz			4	pF
Input capacitance	C _{ib}	V _{EB} =0.5V, I _c =0, f=1MHz			8	pF
Noise figure	NF	V _{CE} =5V, I _c =0.1mA, f=1MHz, R _S =1kΩ			5	dB
Delay time	t _d	V _{CC} =3V, V _{BE(off)} =-0.5V, I _c =10mA, I _{B1} =1mA			35	ns
Rise time	t _r				35	ns
Storage time	t _s	V _{CC} =3V, I _c =10mA			200	ns
Fall time	t _f	I _{B1} =I _{B2} =1mA			50	ns

Typical Characteristics

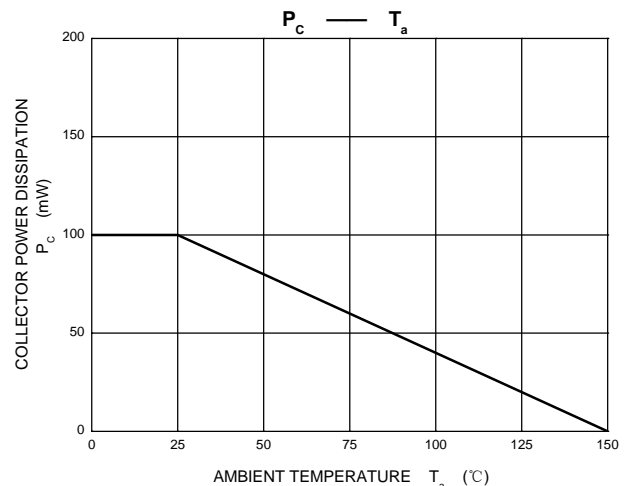
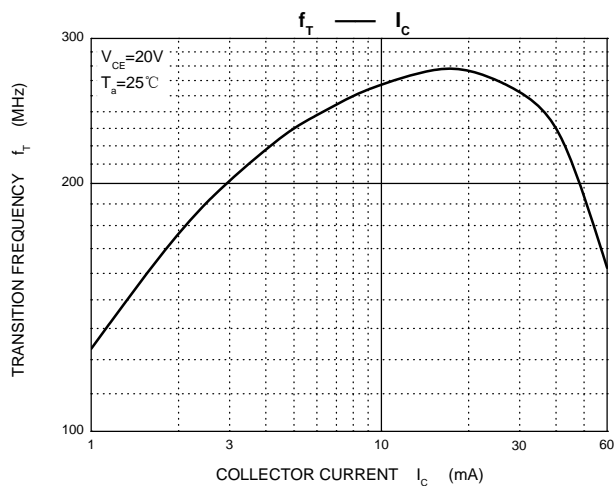
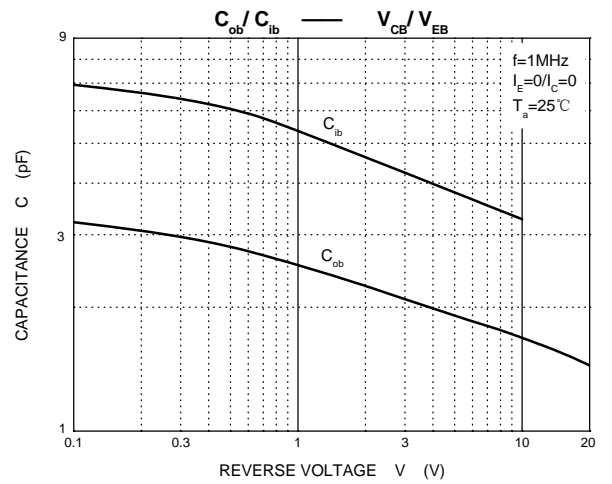
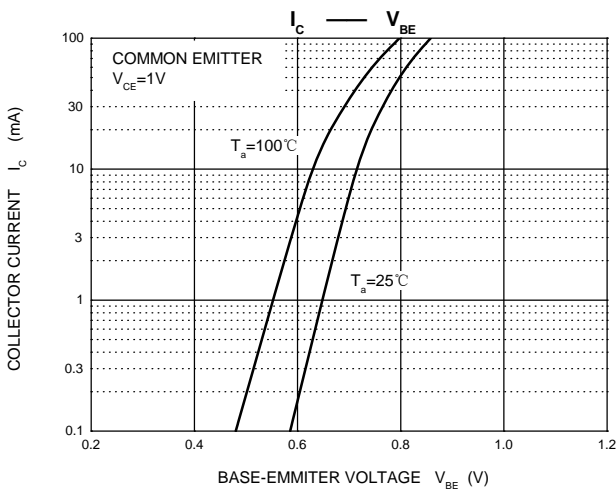
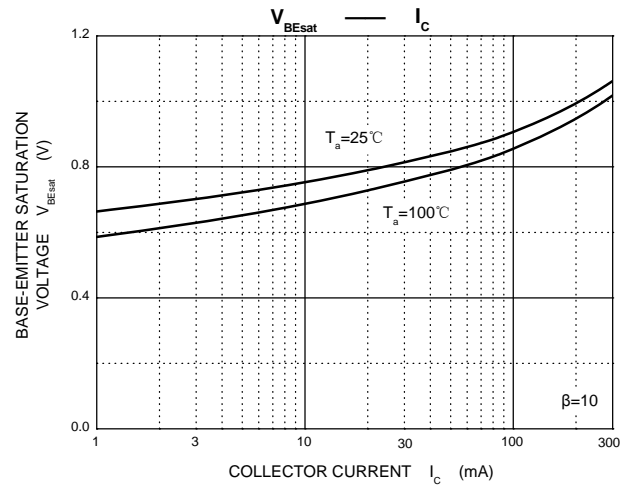
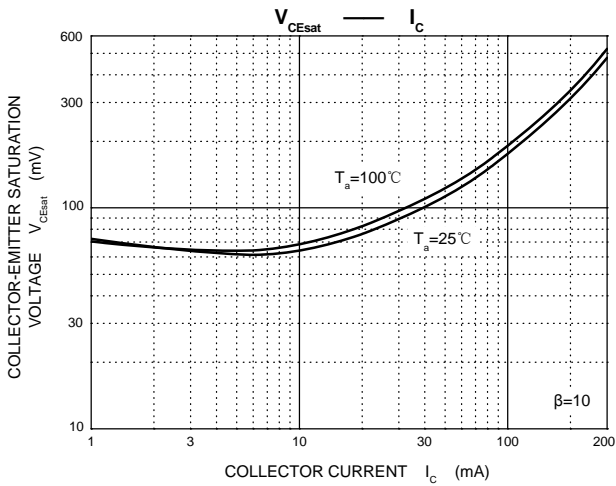
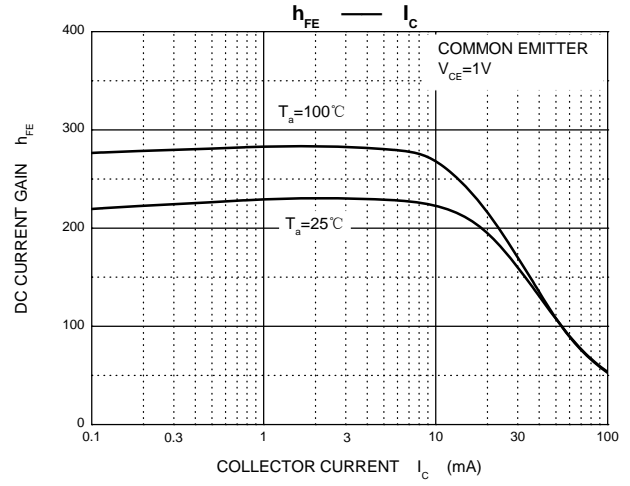
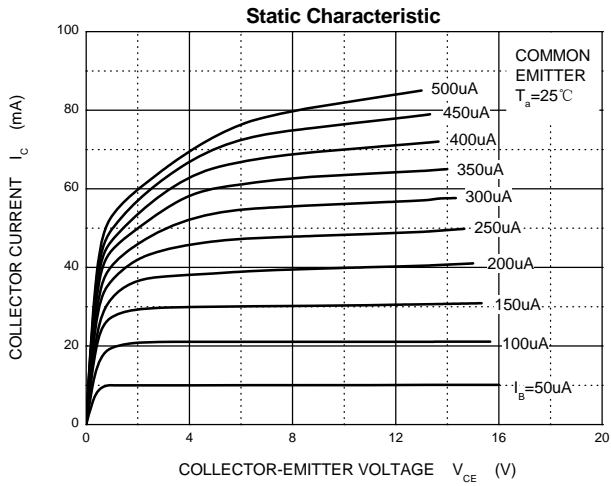

SOT-723 Package Outline Dimensions

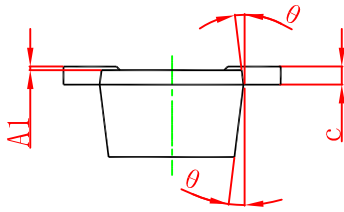
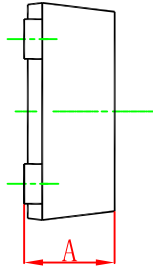
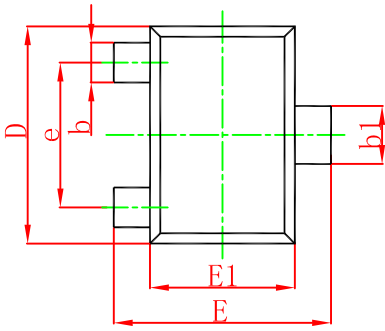

Symbol	Dimensions In Millimeters		Dimensions In Inches	
	Min.	Max.	Min.	Max.
A	0.430	0.500	0.017	0.020
A1	0.000	0.050	0.000	0.002
b	0.170	0.270	0.007	0.011
b1	0.270	0.370	0.011	0.015
c	0.080	0.150	0.003	0.006
D	1.150	1.250	0.045	0.049
E	1.150	1.250	0.045	0.049
E1	0.750	0.850	0.030	0.033
e	0.800TYP.		0.031TYP.	
θ	7° REF.		7° REF.	

SOT-723 Suggested Pad Layout

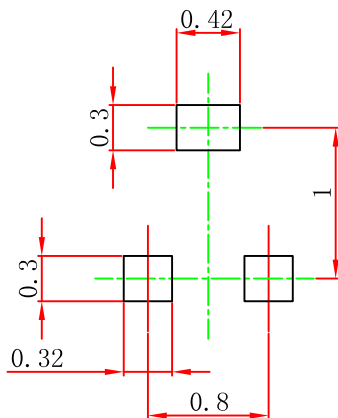

Note:

1. Controlling dimension: in millimeters.
2. General tolerance: $\pm 0.05\text{mm}$.
3. The pad layout is for reference purposes only.

NOTICE

JSCJ reserves the right to make modifications, enhancements, improvements, corrections or other changes without further notice to any product herein. JSCJ does not assume any liability arising out of the application or use of any product described herein.

SOT-723 Tape and Reel

SOT-723 Embossed Carrier Tape

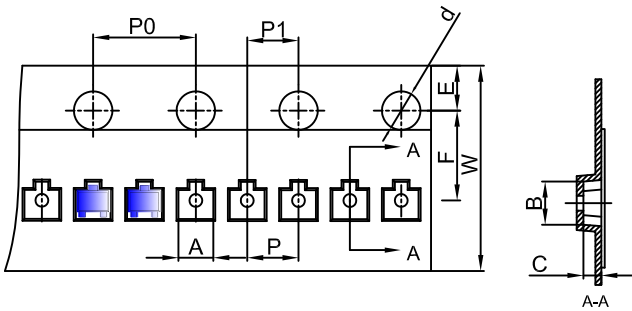

Packaging Description:

SOT-723 parts are shipped in tape. The carrier tape is made from a dissipative (carbon filled) polycarbonate resin. The cover tape is a multilayer film (Heat Activated Adhesive in nature) primarily composed of polyester film, adhesive layer, sealant, and anti-static sprayed agent. These reeled parts in standard option are shipped with 8,000 units per 7" or 17.8cm diameter reel. The reels are clear in color and is made of polystyrene plastic (anti-static coated).

Dimensions are in millimeter										
Pkg type	A	B	C	d	E	F	P0	P	P1	W
SOT-723	1.33	1.45	0.61	Ø1.50	1.75	3.50	4.00	2.00	2.00	8.00

SOT-723 Tape Leader and Trailer

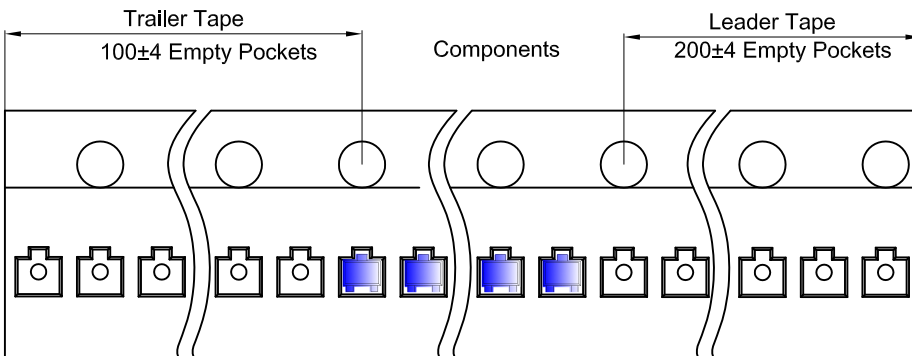

SOT-723 Reel

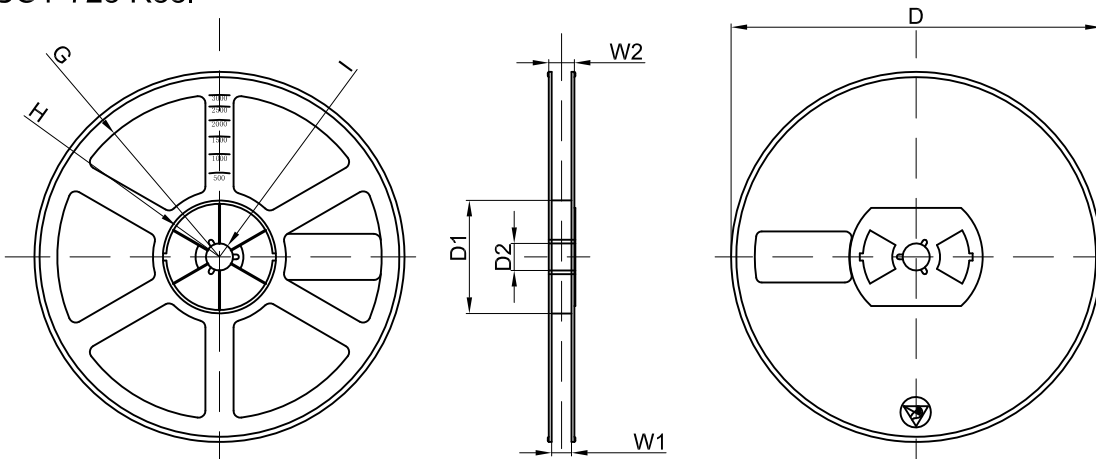

Dimensions are in millimeter								
Reel Option	D	D1	D2	G	H	I	W1	W2
7" Dia	Ø178.00	54.40	13.00	R78.00	R25.60	R6.50	9.50	12.30

REEL	Reel Size	Box	Box Size(mm)	Carton	Carton Size(mm)	G.W.(kg)
8000 pcs	7 inch	120,000 pcs	203×203×195	480,000 pcs	438×438×220	