

Features

- Low Ripple and Noise
- High Efficiency Up To 83%
- Input / Output Isolation : 1K Vdc or 3K Vdc
- 100% Burn-In
- Input Filter With Internal Capacitor
- Custom Design Available
- Net Weight :1.5g or 1.7g Typical
- RoHS Converter Certified By SGS

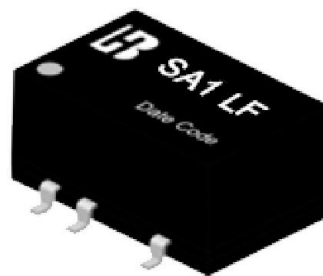

(Specifications typical at Ta= +25°C, Nominal input voltage, Rated output current unless otherwise noted)

Model No.	Input Voltage (Vdc)	Output Voltage (Vdc)	Output Current (mA) Max	Input Current @No Load (mA) Typ.	Input Current @Max. Load (mA) Typ.	Output Ripple (mV) Max.	Load Regulation (%) Max.	Efficiency (%)Typ.
Single Output Series (1 KVdc)								
SA1-3R33R3 LF	3.3	3.3	300	62	459	50	15	70
SA1-3R305 LF		5	200	68	446	60	15	72
SA1-3R309 LF		9	110	61	433	80	12	74
SA1-3R312 LF		12	84	59	421	100	10	76
SA1-3R315 LF		15	67	61	421	120	10	76
SA1-053R3 LF	5	3.3	300	41	290	50	15	73
SA1-0505 LF		5	200	40	282	60	15	75
SA1-0509 LF		9	110	39	270	80	12	78
SA1-0512 LF		12	84	25	263	100	10	80
SA1-0515 LF		15	67	44	270	120	10	78
SA1-123R3 LF	12	3.3	300	14	117	50	15	75
SA1-1205 LF		5	200	15	108	60	15	81
SA1-1209 LF		9	110	15	113	80	12	78
SA1-1212 LF		12	84	15	108	100	10	81
SA1-1215 LF		15	67	14	105	120	10	83
SA1-153R3 LF	15	3.3	300	11	88	50	15	76
SA1-1505 LF		5	200	11	85	60	15	79
SA1-1509 LF		9	110	10	88	80	12	76
SA1-1512 LF		12	84	10	85	100	10	79

SA1-1515 LF		15	67	10	84	120	10	80
SA1-243R3 LF	24	3.3	300	6	66	50	15	67
SA1-2405 LF		5	200	7	62	60	15	71
SA1-2409 LF		9	110	6	60	80	12	73
SA1-2412 LF		12	84	8	58	100	10	76
SA1-2415 LF		15	67	8	58	120	10	77
Dual Output Series (1 KVdc)								
SA1-3R3D3R3 LF	3.3	±3.3	±150	48	446	50	15	68
SA1-3R3D05 LF		±5	±100	48	433	60	15	70
SA1-3R3D09 LF		±9	±55	47	410	80	12	74
SA1-3R3D12 LF		±12	±42	46	400	100	10	76
SA1-3R3D15 LF		±15	±34	46	410	120	10	74
SA1-05D3R3 LF	5	±3.3	±150	35	270	50	15	74
SA1-05D05 LF		±5	±100	35	257	60	15	78
SA1-05D09 LF		±9	±55	33	267	80	12	75
SA1-05D12 LF		±12	±42	48	286	100	10	74
SA1-05D15 LF		±15	±34	33	257	120	10	78
SA1-12D3R3 LF	12	±3.3	±150	16	117	50	15	72
SA1-12D05 LF		±5	±100	15	108	60	15	78
SA1-12D09 LF		±9	±55	15	113	80	12	75
SA1-12D12 LF		±12	±42	15	108	100	10	78
SA1-12D15 LF		±15	±34	14	105	120	10	80
SA1-15D3R3 LF	15	±3.3	±150	12	93	50	15	72
SA1-15D05 LF		±5	±100	11	88	60	15	76
SA1-15D09 LF		±9	±55	11	88	80	12	76
SA1-15D12 LF		±12	±42	11	86	100	10	78
SA1-15D15 LF		±15	±34	10	86	120	10	78
SA1-24D3R3 LF	24	±3.3	±150	8	58	50	15	72
SA1-24D05 LF		±5	±100	8	58	60	15	72
SA1-24D09 LF		±9	±55	7	58	80	12	73
SA1-24D12 LF		±12	±42	7	55	100	10	76
SA1-24D15 LF		±15	±34	7	56	120	10	75
Single Output Series (3 KVdc)								
SA1-3R33R3H LF	3.3	3.3	300	47	446	50	15	68
SA1-3R305H LF		5	200	47	421	60	15	72
SA1-3R309H LF		9	110	47	400	80	12	76
SA1-3R312H LF		12	84	45	410	100	10	74

SA1-3R315H LF		15	67	45	410	120	10	74
SA1-053R3H LF	5	3.3	300	25	274	50	15	77
SA1-0505H LF		5	200	25	260	60	15	81
SA1-0509H LF		9	110	23	270	80	12	78
SA1-0512H LF		12	84	25	263	100	10	80
SA1-0515H LF		15	67	28	260	120	10	81
SA1-123R3H LF	12	3.3	300	14	117	50	15	75
SA1-1205H LF		5	200	20	117	60	15	75
SA1-1209H LF		9	110	15	113	80	12	78
SA1-1212H LF		12	84	15	108	100	10	81
SA1-1215H LF		15	67	14	109	120	10	83
SA1-153R3H LF	15	3.3	300	11	88	50	15	76
SA1-1505H LF		5	200	11	85	60	15	79
SA1-1509H LF		9	110	10	88	80	12	76
SA1-1512H LF		12	84	10	85	100	10	79
SA1-1515H LF		15	67	10	84	120	10	80
SA1-243R3H LF	24	3.3	300	6	66	50	15	67
SA1-2405H LF		5	200	7	62	60	15	71
SA1-2409H LF		9	110	6	60	80	12	73
SA1-2412H LF		12	84	8	58	100	10	76
SA1-2415H LF		15	67	8	58	120	10	77

Dual Output Series (3 KVdc)

SA1-3R3D3R3H LF	3.3	±3.3	±150	48	446	50	15	68
SA1-3R3D05H LF		±5	±100	48	433	60	15	70
SA1-3R3D09H LF		±9	±55	47	410	80	12	74
SA1-3R3D12H LF		±12	±42	46	400	100	10	76
SA1-3R3D15H LF		±15	±34	46	410	120	10	74
SA1-05D3R3H LF	5	±3.3	±150	35	270	50	15	74
SA1-05D05H LF		±5	±100	35	257	60	15	78
SA1-05D09H LF		±9	±55	33	267	80	12	75
SA1-05D12H LF		±12	±42	33	259	100	10	77
SA1-05D15H LF		±15	±34	33	257	120	10	78
SA1-12D3R3H LF	12	±3.3	±150	16	117	50	15	72
SA1-12D05H LF		±5	±100	15	108	60	15	78
SA1-12D09H LF		±9	±55	15	113	80	12	75
SA1-12D12H LF		±12	±42	15	108	100	10	78
SA1-12D15H LF		±15	±34	14	105	120	10	80

SA1-15D3R3H LF	15	±3.3	±150	12	93	50	15	72
SA1-15D05H LF		±5	±100	11	88	60	15	76
SA1-15D09H LF		±9	±55	11	88	80	12	76
SA1-15D12H LF		±12	±42	11	86	100	10	78
SA1-15D15H LF		±15	±34	10	86	120	10	78
SA1-24D3R3H LF	24	±3.3	±150	8	58	50	15	72
SA1-24D05H LF		±5	±100	8	58	60	15	72
SA1-24D09H LF		±9	±55	7	58	80	12	73
SA1-24D12H LF		±12	±42	7	55	100	10	76
SA1-24D15H LF		±15	±34	7	56	120	10	75

Notes :

1. Load regulation is for output current change from 10% to 100% Max .Load.

3 . Absolute Maximum Ratings

(Exceeding these values may damage the module. These are not continuous operating ratings)

Parameter	Condition	Min.	Typ.	Max.	Unit
Input Absolute Voltage Range	3.3V Input Model	-0.7	3.3	4.2	Vdc
	5V Input Model	-0.7	5	7	
	12V Input Model	-0.7	12	15	
	15V Input Model	-0.7	15	18	
	24V Input Model	-0.7	24	28	
Max. Output Power		---	---	1.0	W
Operation Temperature (Ambient Temperature)	Output Full Load	-40	---	+85	°C
Storage Temperature		-55	---	+125	
Lead Temperature 1.5 mm From Case For 10 Seconds		---	---	+260	
Peak Airflow Temperature With CECC 00802 Profile		---	---	+245	

4 . Nominal Input/Output Electrical Specifications

(Specifications typical at Ta= +25°C , Nominal input voltage, Rated output current unless otherwise noted)

Parameter	Condition	Min.	Typ.	Max.	Unit
Input Voltage Range	3.3V Input Model	2.97	3.3	3.63	Vdc
	5V Input Model	4.5	5	5.5	
	12V Input Model	10.8	12	13.2	
	15V Input Model	13.5	15	15.5	
	24V Input Model	21.6	24	26.4	
Output Voltage Accuracy	Nominal Input	---	3.0	5.0	%
Output Voltage Balance		---	---	±1.0	---

Switching Frequency		60	100	150	KHz
Temperature Coefficient		---	±0.01	±0.02	%/ °C
Isolation Voltage	60 Second	1000	---	---	Vdc
	60 Second	3000	---	---	Vdc
Isolation Resistance	500Vdc	1000	---	---	MΩ
Isolation Capacitance	3.3V Input Model	---	12	---	pF
	5V Input Model	---	16	---	
	12V Input Model	---	16	---	
	15V Input Model	---	16	---	
	24V Input Model	---	16	---	
Max. Line Regulation (Per1.0% change in input change)	---	---	---	1.5	%

5 . General Specification

Parameter	Specification	Condition
Isolation Voltage	1000 Vdc	Test Duration 60 Seconds / 0.5 mA
Isolation Resistance	1000 MΩ Min.	@ 500 Vdc
Operating Temperature (1)	-40°C ~ +85°C	@ Ambient Temperature With Natural Convection
Operating Temperature (2)	-40°C ~ +95°C	@ Case Surface Temperature
Storage Temperature	-55°C ~ +125°C	---
Humidity	Up To 90 %	---
Cooling	Free Air Convection	---

6 . Ordering Information

SA1-xxSyyH LF

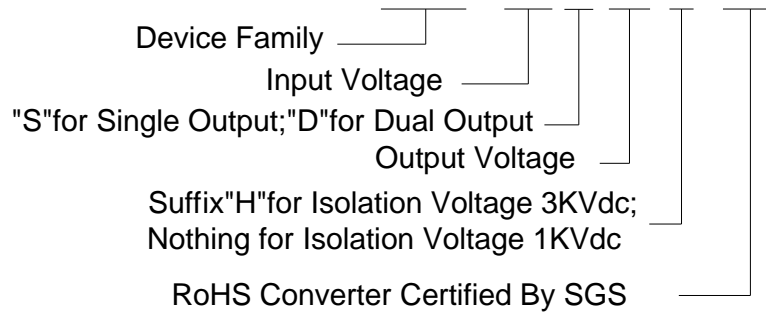

7 . Performance Characteristics

Temperature derating graph

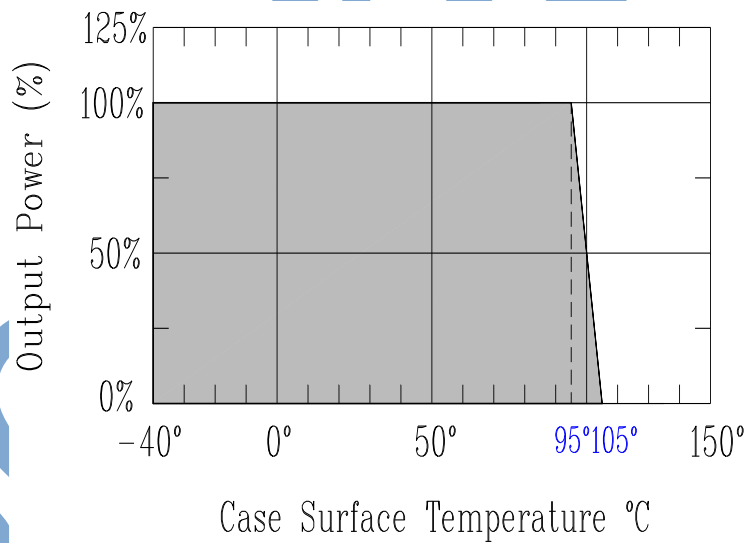

8 . Mechanical & Pin Connections

Single Output Series (For Isolation Voltage 1KVdc)

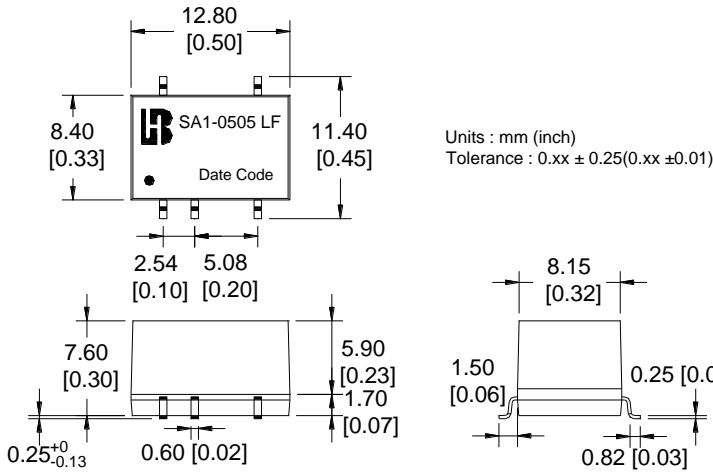

Pin	1K Vdc - Single		Pin
1	-Vin	NC	14
3	+Vin	No Pin	12
5	No Pin		10
7	-Vo	+Vo	8

Dual Output Series (For Isolation Voltage 1KVdc)

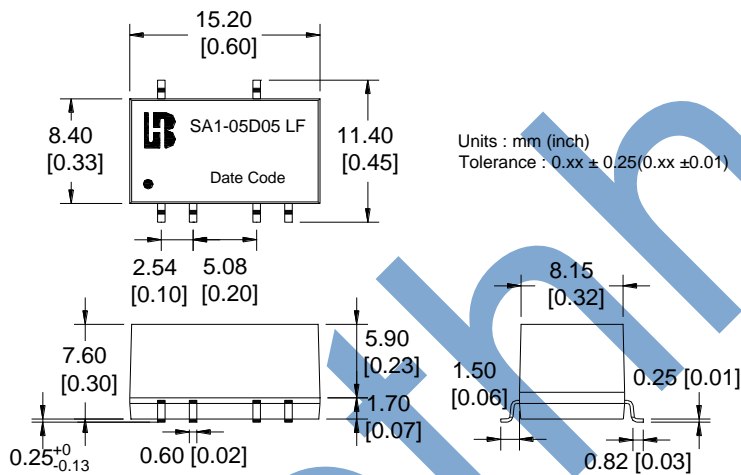

Pin	1K Vdc - Dual		Pin
1	-Vin	NC	18
3	+Vin	No Pin	16
5	No Pin		14
7	com	+Vo	12
9	-Vo	No Pin	10

Single Output Series (For Isolation Voltage 3KVdc)

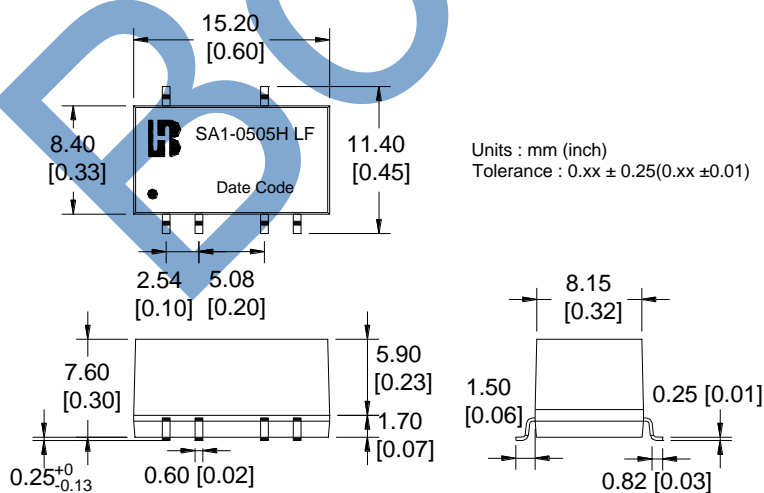

Pin	3K Vdc - Single		Pin
1	-Vin	NC	18
3	+Vin	No Pin	16
5	No Pin		14
7	-Vo	+Vo	12
9	NC	No Pin	10

Dual Output Series (For Isolation Voltage 3KVdc)

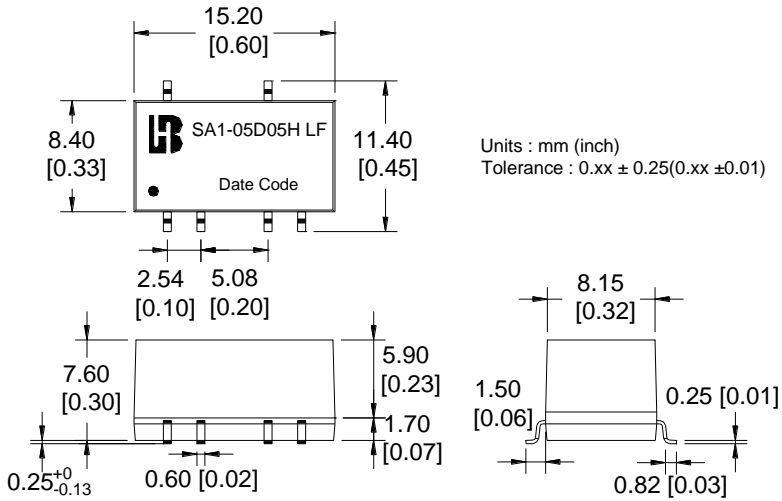

Pin	3K Vdc - Dual		Pin
1	-Vin	NC	18
3	+Vin	No Pin	16
5	No Pin		14
7	com	+Vo	12
9	-Vo	No Pin	10

9. Recommended Footprint Details

Single Output Series

For Isolation Voltage 1KVdc

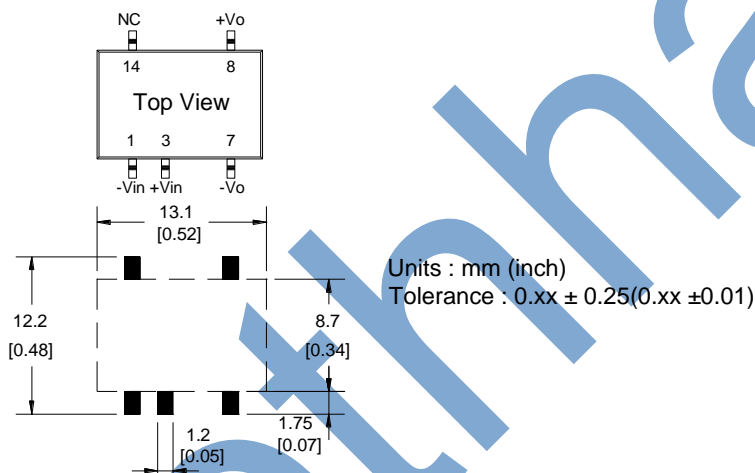

Dual Output Series

For Isolation Voltage 3KVdc

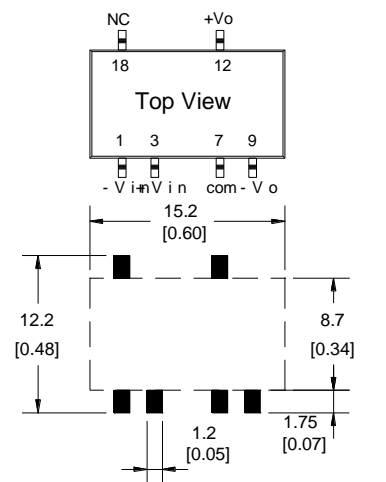
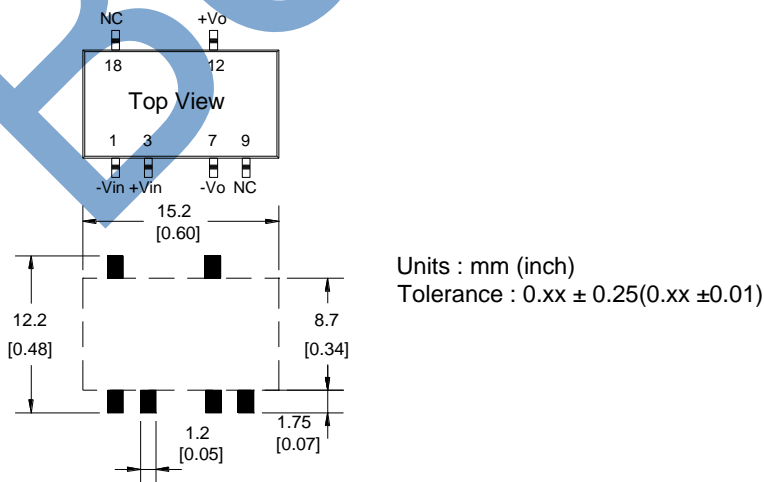

10. Package

Single Output Series For Isolation 1KVdc

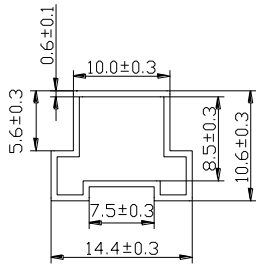

TUBE MECHANICAL DIMENSION

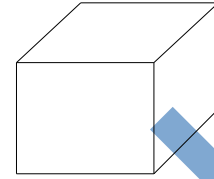
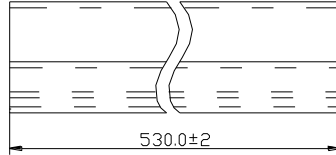

INNER CARTON:565*115*117

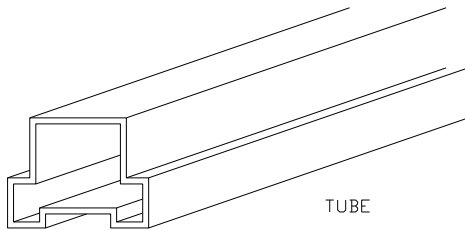

TUBE

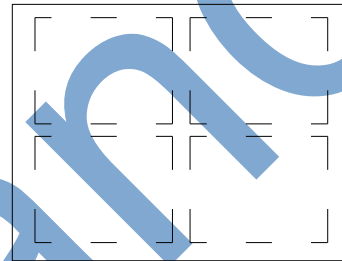

EXPORT CARTON:580*255*265

1. TUBE=39PCS
2. INNER CARTON=63 TUBE=63*39=2457PCS
3. EXPORT CARTON=4 INNER CARTON=4*2457=9828PCS

Single Output Series For Isolation 3KVdc

Dual Output Series For Isolation 1KVdc and 3KVdc

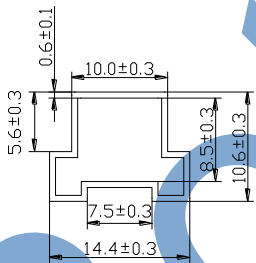

TUBE MECHANICAL DIMENSION

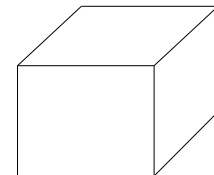
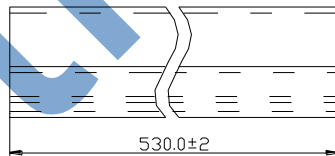

INNER CARTON:565*115*117

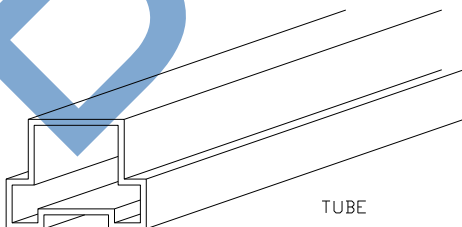

TUBE

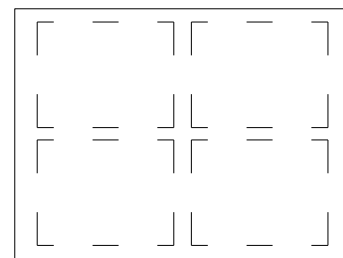

EXPORT CARTON:580*255*265

1. TUBE=33PCS
2. INNER CARTON=63 TUBE=63*33=2079PCS
3. EXPORT CARTON=4 INNER CARTON=4*2079=8316PCS

Single Output Series For Isolation 1KVdc

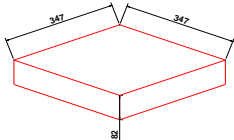
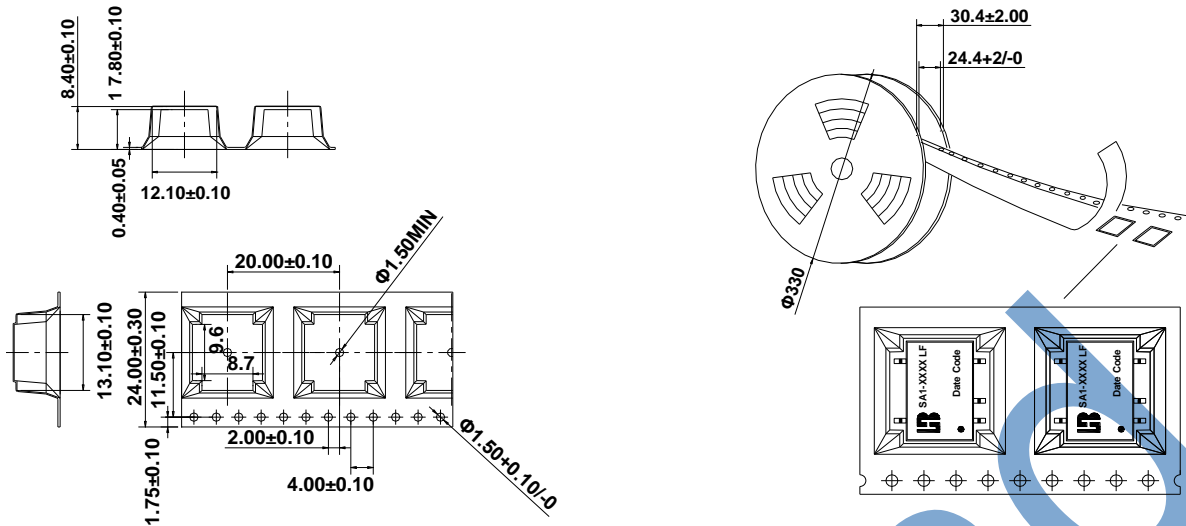

Inner Carton: 347*347*82mm

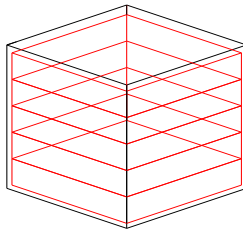

Export Carton:375*375*460mm

- 1、Packaging Number of 13":350PCS/R
- 2、Inner Carton=1 R=1*350=350PCS
- 3、Export Carton=5 Inner Carton=5*350=1750PCS

Single Output Series For Isolation 3KVdc

Dual Output Series For Isolation 1KVdc and 3KVdc

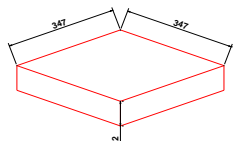
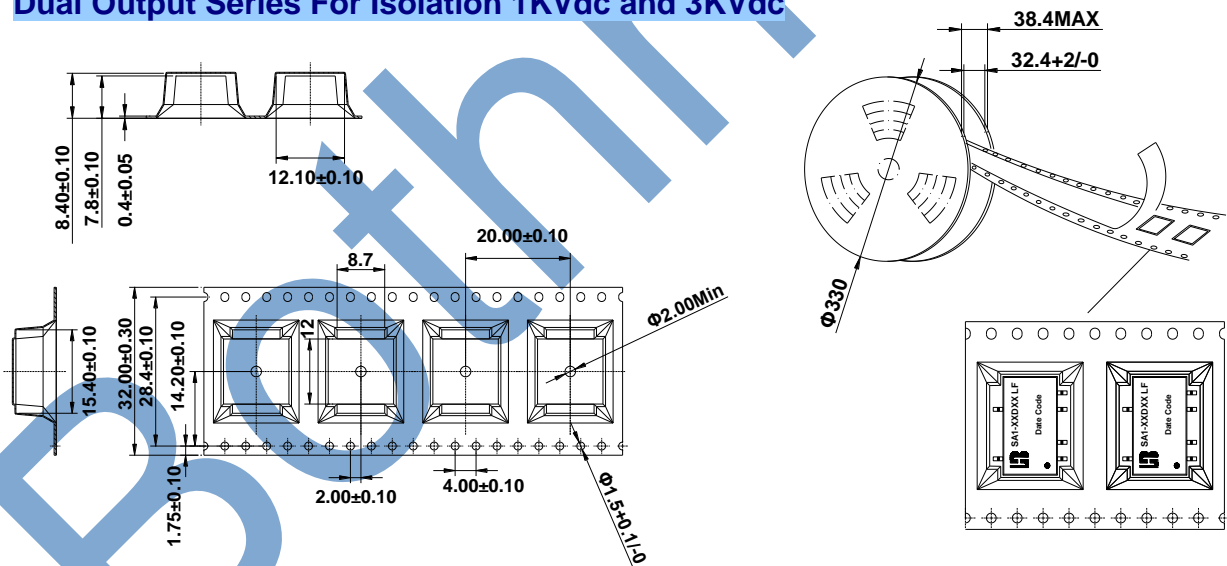

Inner Carton: 347*347*82mm

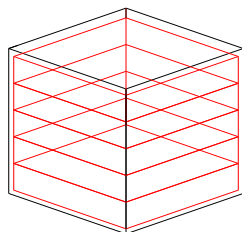

Export Carton:375*375*460mm

- 1、Packaging Number of 13":350PCS/R
- 2、Inner Carton=1 R=1*350=350PCS
- 3、Export Carton=5 Inner Carton=5*350=1750PCS

Application note

Test Configurations :

All specifications are typical at nominal input, full load and 25°C unless otherwise stated.

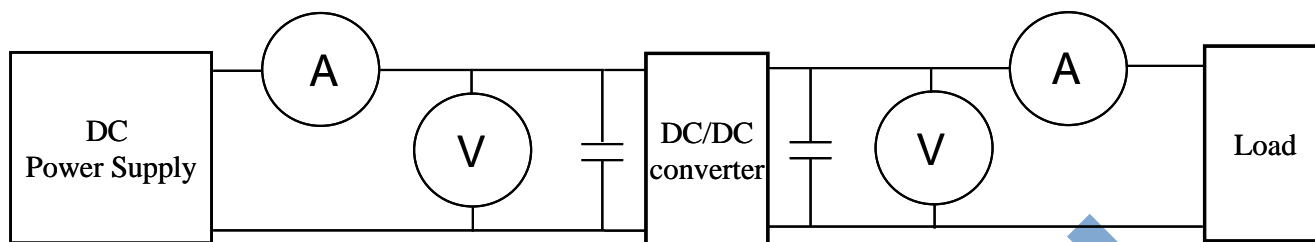

© DC Power Supply: It offers a wide voltage and current range precisely.

© Current meter (A): Accuracy → 200μA ~ 200mA 4 ranges ±(0.2% rdg + 2 digits)

2000mA ~ 20A 2 ranges ±(0.3% rdg + 2 digits).

© Voltage meter (V): Accuracy → ±(0.03% rdg + 4 digits).

© Load: At full load.

© Wires: The resistance of the wires must be small.

1. Input voltage range: Narrow input voltage range (±10%)、wide input voltage range (2:1 and 4:1)。

EX: Narrow input voltage range (±10%)

5VDC nominal input → 4.5~5.5VDC

12VDC nominal input → 10.8~13.2VDC

24VDC nominal input → 21.6~26.4VDC

Wide input voltage range 2:1

5VDC nominal input → 4.5~9VDC

12VDC nominal input → 9~18VDC

24VDC nominal input → 18~36VDC

48VDC nominal input → 36~75VDC

Wide input voltage range 4:1 (W)

24VDC nominal input → 9~36VDC

48VDC nominal input → 18~75VDC

2. Input power :

$$P_{in} = V_{in} \times I_{in}$$

V_{in} : Input voltage

I_{in} : Input current

3. Output power :

$$P_{out} = V_{out} \times I_{out}$$

V_{out} : Output voltage

I_{out} : Output current

4. Efficiency :

$$\text{Efficiency} = \frac{P_{out}}{P_{in}} \times 100\%$$

P_{out} : Output power

P_{in} : Input power

5. Voltage accuracy:

$$\frac{|V_{out} - V_{out(nominal)}|}{V_{out}} \times 100\%$$

V_{out} : Output voltage

$V_{out(nominal)}$: Nominal output voltage

6. Line regulation: (1) Wide input voltage range and regulated output voltage series.

$$\frac{|V_{out(LL)} - V_{out(HL)}|}{V_{out(LL)}} \times 100\%$$

LL: Low Line input voltage

HL: High Line input voltage

(2) Narrow input voltage range ($\pm 10\%$) and unregulated output voltage series.

$$\text{Line regulation} = \frac{\Delta V_{out}}{\Delta V_{in}}$$

$$\Delta V_{out} = \frac{V_{out(+10\%)} - V_{out(-10\%)}}{V_{out}} \times 100\%$$

$V_{out(+10\%)}$: Output voltage at $V_{in} = 1.1 \times V_{in(nominal)}$ & full load

$V_{out(-10\%)}$: Output voltage at $V_{in} = 0.9 \times V_{in(nominal)}$ & full load

V_{out} : Output voltage at $V_{in} = V_{in(nominal)}$ & full load

$$\Delta V_{in} = \frac{V_{in(+10\%)} - V_{in(-10\%)}}{V_{in(nominal)}} \times 100\%$$

$V_{in}(+10\%)$: Input voltage = $1.1 \times V_{in}(\text{nominal})$

$V_{in}(-10\%)$: Input voltage = $0.9 \times V_{in}(\text{nominal})$

$V_{in}(\text{nominal})$: Nominal Input voltage

7. Load regulation :

$$\frac{|V_{out}(\text{FL}) - V_{out}(\text{NL})|}{V_{out}(\text{FL})} \times 100\%$$

$V_{out}(\text{FL})$: Output voltage at full load

$V_{out}(\text{NL})$: Output voltage at 25% full load or 10% full load

8. Ripple and Noise: as shown below. The bandwidth is 0-20MHz.

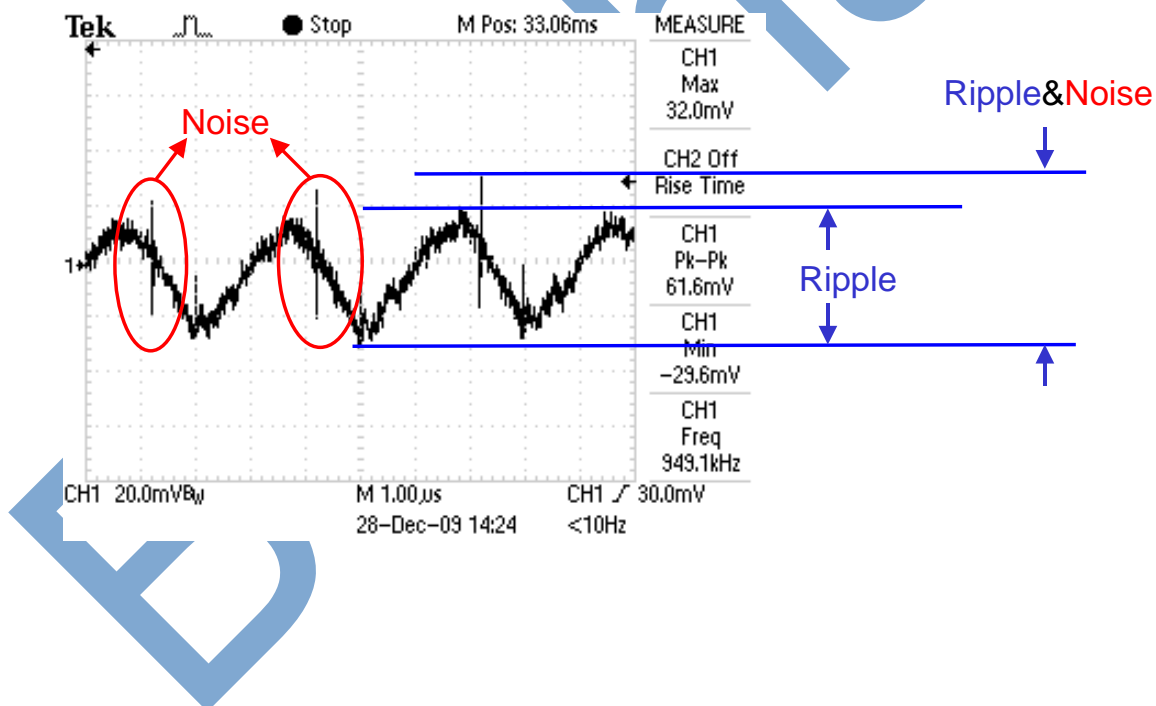

Output Ripple&Noise measurement test circuit: as shown below.

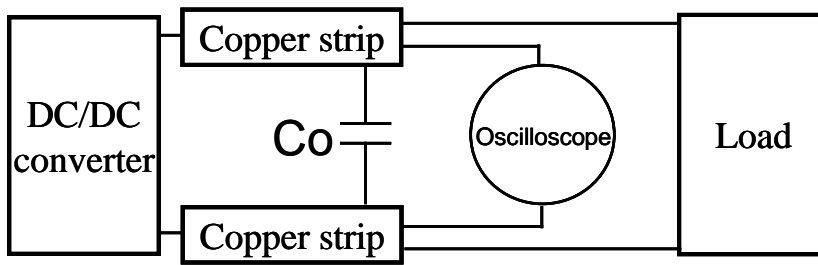

Co: usually 0.47uF.

1. [Temperature derating curve](#): The DC-DC converter will operate over a wider temperature range if less power is drawn from the output and the device is already running. The temperature derating curve shows the operating power-temperature range. As shown below.

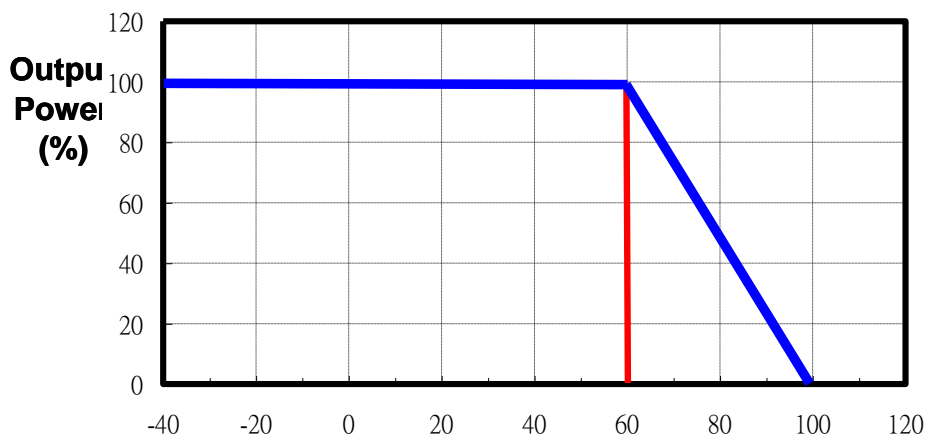

10. [Switching frequency](#): The nominal operating frequency of the DC-DC converters.
11. [Input to output isolation](#): The dielectric breakdown strength test between input and output circuits. This is the isolation voltage the device is capable of withstanding for a specified time, usually 1 second or 1 minute.

Pb-free SMD Package AIR Reflow Profile

Step#	Profile Feature	Condition / Duration
Step1	Ramp-up rate	3°C/sec max
Step2	Preheat : 150~200°C	Ta-Tb: 60-180 sec
Step3	Ramp-up rate (TL to Tp)	3°C/sec max
	Temperature maintained above 217°C (TL)	tL: 60-150sec
Step4	Peak temperature (Tp)	245+0°C/-5°C
	The Time of Actual peak temperature	20-40sec
Step5	Ramp-down rate	6°C/sec max
Note1	All temperatures refer to topside of the package, measured on the package body surface.	
Note2	Time 25°C to peak temperature: 8 minutes max	
Note3	It is not allowed to make a forced cooling in temperature falling range.	

