

8V Input , 300mA , Low power , CMOS LDO
Description

AF6206N series are a highly precise, lower consumption, 3 terminal, positive voltage regulators manufactured using CMOS and laser trimming technologies.

The AF6206N consists of a current limiter circuit, a driver transistor, a precision reference voltage and an error correction circuit. The current limiter is fold-back circuit operates as a short circuit protection as well as the output current limiter for the output pin. Output voltages are internally by laser trimming technologies.

Applications

- Portable consumer equipment
- Wireless handsets, Smart Phones
- Bluetooth, Digital cameras and Digital audio
- PDAs and other handheld products

Device Information

AF 6206N – XX N/M/P R/G

① ② ③ ④ ⑤

①	Standard
②	Product Name
③	Output Voltage e.g. 12 = 1.2V
④	N: SOT23 Package
	M: SOT23-3 Package
	P: SOT89 Package
⑤	R: RoHS/Pb Free
	G: Halogen Free

Features

- Input Voltage Range: up to 8V
- Output Voltage Range: 1.2V~5V
- Output Current: 300mA
- Quiescent Current: 3uA
- Fixed Voltage Accuracy: $\pm 2\%$ (Typ.)
- PSRR: 50dB at 1kHz
- Low voltage drop
- Low temperature coefficient
- Compatible with low ESR ceramic capacitors
- Available in SOT-23/SOT23-3 and SOT-89 packages

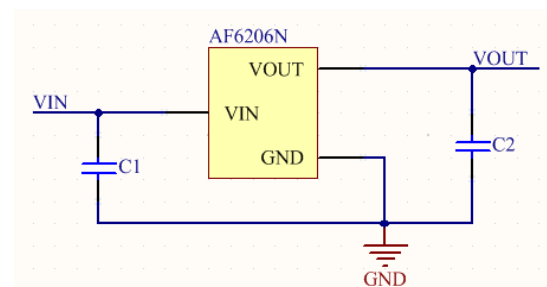
Typical Application

Pin Configuration

Symbol	Package Pin	
	SOT23	SOT89
GND	1	1
OUT	2	3
VIN	3	2



AF6206N Series

✚ Absolute Maximum Ratings⁽¹⁾

(Unless otherwise specified, all voltage are with respect to GND, TA=25°C)

PARAMETER	SYMBOL	RATINGS	UNITS
Input Voltage	V _{IN}	-0.3~10	V
Output Voltage	V _{OUT}	-0.3~V _{IN}	V
Output Current	I _{OUT}	350	mA
Power Dissipation	SOT23	0.25	W
	SOT23-3	0.3	W
	SOT89	0.5	W
Operating Junction Temperature Range	T _J	-40~125	°C
Maximum Ambient Temperature	T _A	100	°C
Storage Temperature	T _{STG}	-40~125	°C
Lead Temperature(Soldering, 10 sec)	T _L	260	°C

(1). Stresses beyond those listed under absolute maximum ratings may cause permanent damage to the device. These are stress ratings only, and functional operation of the device at these or any other conditions beyond those indicated under recommended operating conditions is not implied. Exposure to absolute-maximum-rated conditions for extended periods may affect device reliability.

✚ Thermal Resistance Ratings(T_A=25°C unless otherwise noted)

Parameter	Package	Symbol	Rating	Unit
Package Thermal Resistance	SOT23	R _{θJA}	300	°C/W
	SOT23-3		250	
	SOT89		150	



AF6206N Series

✚ Electronics Characteristics

(Unless otherwise specified, $V_{IN}=V_{OUT}+1V$, $C_{IN}=C_{OUT}=1\mu F$, $T_A=25^\circ C$)

PARAMETER	SYMBOL	CONDITIONS	MIN	TYP	MAX	UNIT
Input Voltage	V_{IN}				8	V
Output Voltage	V_{OUT}		0.98 V_{OUT}	V_{OUT}	1.02 V_{OUT}	V
Dropout Voltage	V_{DIF}	$I_{OUT}=100$ mA	$V_{OUT}\leq 1.5V$		0.35	V
			$1.8V\leq V_{OUT}\leq 2V$		0.28	
			$2.8V\leq V_{OUT}\leq 5V$		0.19	
Quiescent Current	I_Q	$I_{OUT}=0$		3	5	μA
Line Regulation	ΔV_{LINE}	$I_{OUT}=40mA$ $V_{OUT}+1V\leq V_{IN}\leq 8V$		0.05	0.2	%/V
Load Regulation	ΔV_{LOAD}	$V_{IN}=V_{OUT}+1V$ $1mA\leq I_{OUT}\leq 80mA$		12	30	mV
Temperature Coefficient	TC	$I_{OUT}=30mA$ $0^\circ C < T_A < 75^\circ C$		100		ppm
Power Supply Rejection Ratio	PSRR	$I_{OUT}=50mA$ 1kHz		50		dB
Output Noise		10Hz~100kHz		30		μV_{RMS}

Typical Characteristics

(Unless otherwise specified, $V_{IN}=V_{OUT}+1V$, $C_{IN}=C_{OUT}=1\mu F$, $T_A=25^\circ C$)

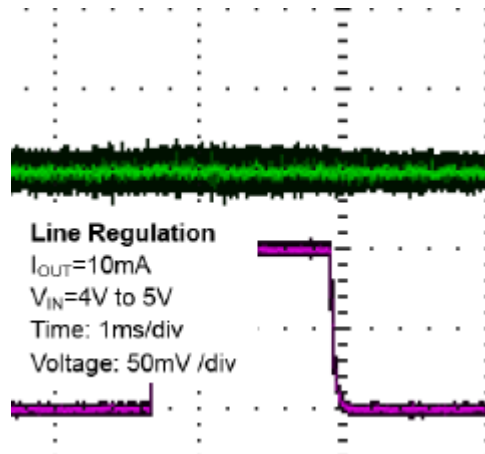
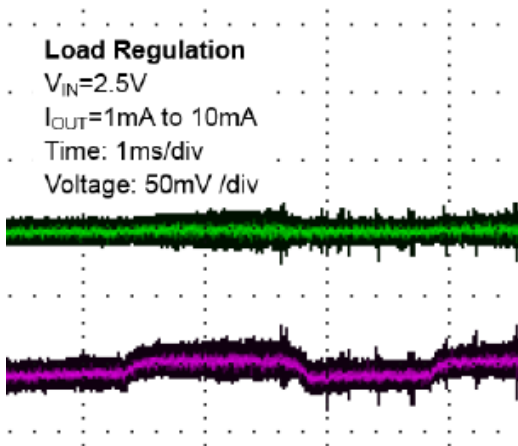
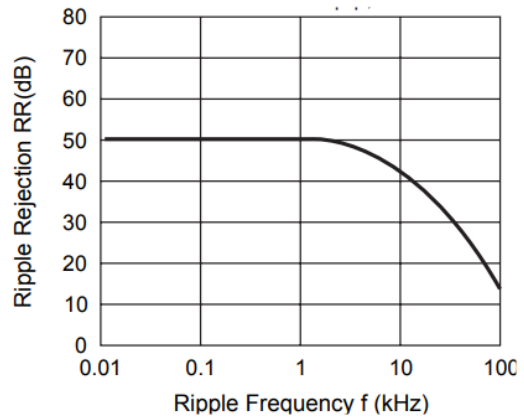
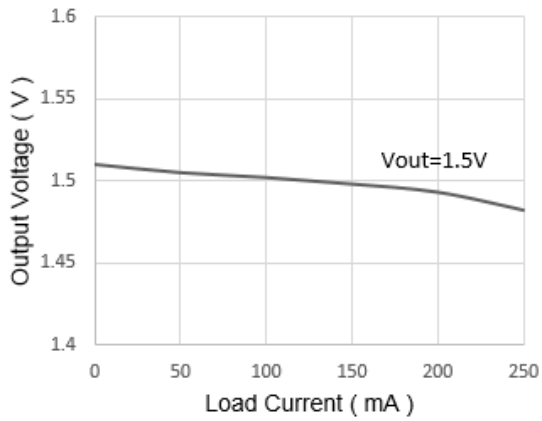
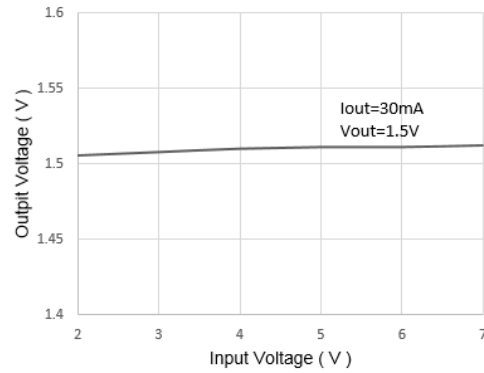
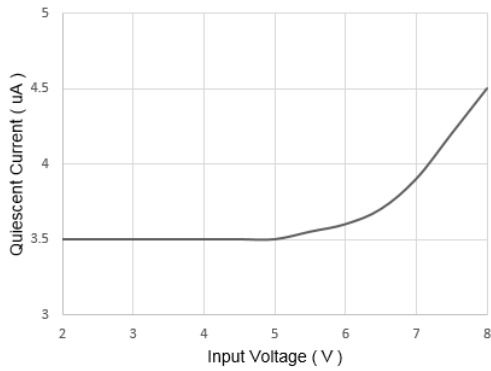

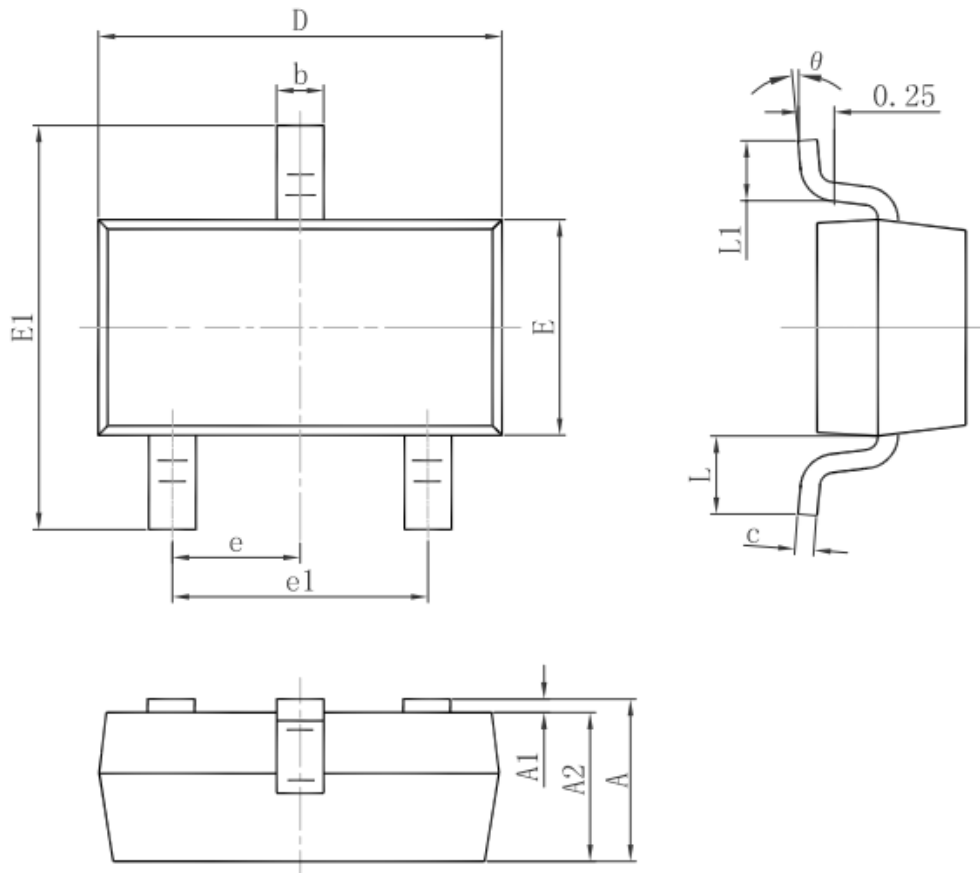
Package Information
SOT23

Symbol	Dimensions In Millimeters		Dimensions In Inches	
	Min.	Max.	Min.	Max.
A	0.900	1.150	0.035	0.045
A1	0.000	0.100	0.000	0.004
A2	0.900	1.050	0.035	0.041
b	0.300	0.500	0.012	0.020
c	0.080	0.150	0.003	0.006
D	2.800	3.000	0.110	0.118
E	1.200	1.400	0.047	0.055
E1	2.250	2.550	0.089	0.100
e	0.950 TYP.		0.037 TYP.	
e1	1.800	2.000	0.071	0.079
L	0.550 REF.		0.022 REF.	
L1	0.300	0.500	0.012	0.020
θ	0°	8°	0°	8°

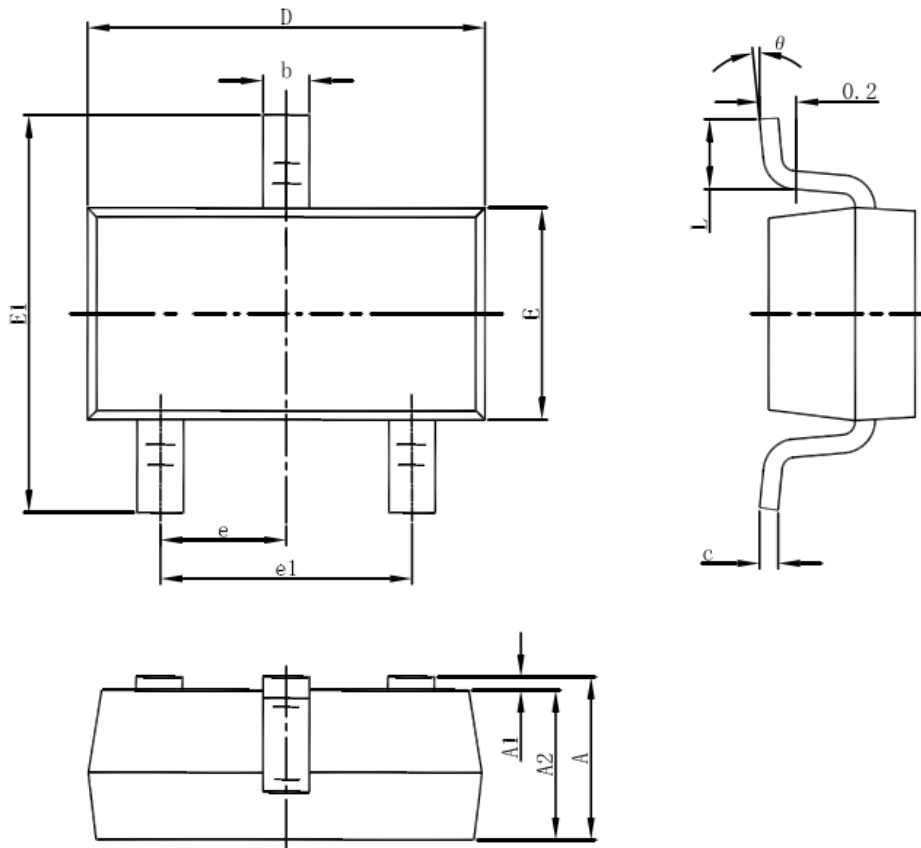
SOT23-3

Symbol	Dimensions In Millimeters		Dimensions In Inches	
	Min	Max	Min	Max
A	1.050	1.250	0.041	0.049
A1	0.000	0.100	0.000	0.004
A2	1.050	1.150	0.041	0.045
b	0.300	0.500	0.012	0.020
c	0.100	0.200	0.004	0.008
D	2.820	3.020	0.111	0.119
E	1.500	1.700	0.059	0.067
E1	2.650	2.950	0.104	0.116
e	0.950(BSC)		0.037(BSC)	
e1	1.800	2.000	0.071	0.079
L	0.300	0.600	0.012	0.024
θ	0°	8°	0°	8°

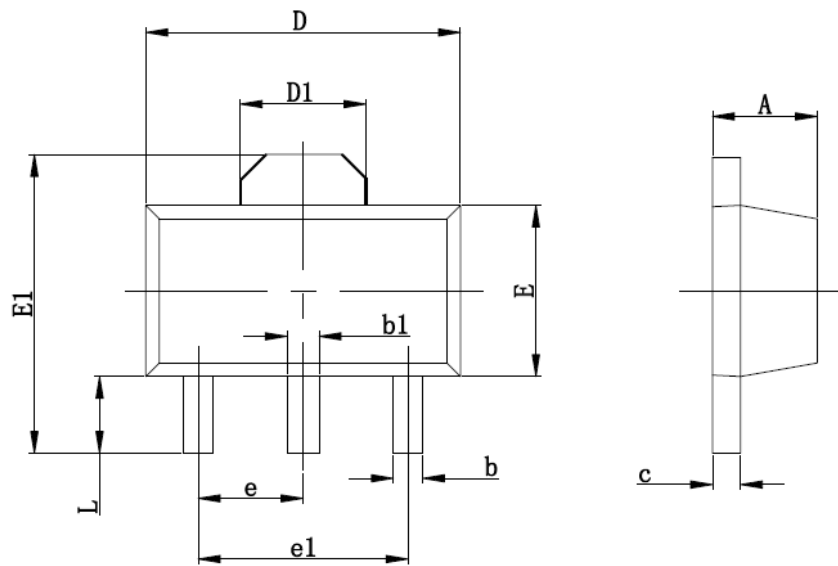
SOT89

Symbol	Dimensions In Millimeters		Dimensions In Inches	
	Min	Max	Min	Max
A	1.400	1.600	0.055	0.063
b	0.350	0.520	0.013	0.197
b1	0.400	0.580	0.016	0.023
c	0.350	0.440	0.014	0.017
D	4.400	4.600	0.173	0.181
D1	1.550 REF		0.061 REF	
E	2.350	2.550	0.091	0.102
E1	3.940	4.250	0.155	0.167
e	1.500 TYP		0.060TYP	
e1	3.000 TYP		0.118TYP	
L	0.900	1.100	0.035	0.047



✚ Marking Rule

① Represents product number

Mark: 6

② Represents 3 pins regulator

Mark: 5(Voltage=0.1V~3V)

6(Voltage=3.1V~6V)

③ Represents output voltage

Mark	Voltage(V)		Mark	Voltage(V)	
0		3.1	F	1.6	4.6
1		3.2	H	1.7	4.7
2		3.3	K	1.8	4.8
3		3.4	L	1.9	4.9
4		3.5	M	2.0	5.0
5		3.6	N	2.1	
6		3.7	P	2.2	
7		3.8	R	2.3	
8		3.9	S	2.4	
9		4.0	T	2.5	
A		4.1	U	2.6	
B	1.2	4.2	V	2.7	
C	1.3	4.3	X	2.8	
D	1.4	4.4	Y	2.9	
E	1.5	4.5	Z	3.0	

④ X

✚ Packing Information

Package	Packing	Shipping
SOT23	Tape and Reel	3K/Reel
SOT23-3		3K/Reel
SOT89-3		1K/Reel



History Version

V1.0	Produce datasheet	2019-09-09
V2.0	Add ambient temperature and thermal resistance	2020-09-15

DISCLAIMER

AFSEMI RESERVES THE RIGHT TO MAKE CHANGES WITHOUT FURTHER NOTICE TO ANY PRODUCTS HEREIN TO IMPROVE RELIABILITY, FUNCTION OR DESIGN. AFSEMI DOES NOT ASSUME ANY LIABILITY ARISING OUT OF THE APPLICATION OR USE OF ANY PRODUCT OR CIRCUIT DESCRIBED HEREIN; NEITHER DOES IT CONVEY ANY LICENCE UNDER ITS PATENT RIGHTS, NOR THE RIGHTS OF OTHERS.

THE GRAPHS PROVIDED IN THIS DOCUMENT ARE STATISTICAL SUMMARIES BASED ON A LIMITED NUMBER OF SAMPLES AND ARE PROVIDED FOR INFORMATIONAL PURPOSE ONLY. THE PERFORMANCE CHARACTERISTICS LISTED IN THEM ARE NOT TESTED OR GUARANTEED. IN SOME GRAPHS, THE DATA PRESENTED MAY BE OUTSIDE THE SPECIFIED OPERATING RANGE (E.G. OUTSIDE SPECIFIED POWER SUPPLY RANGE) AND THEREFORE OUTSIDE THE WARRANTED RANGE.