

## 30V N-Channel Mosfet

### FEATURES

- $R_{DS(ON)} \leq 33m\Omega$  ( 21m $\Omega$  Typ.)  
@ $V_{GS}=10V$
- $R_{DS(ON)} \leq 39m\Omega$  ( 25m $\Omega$  Typ.)  
@ $V_{GS}=4.5V$
- $R_{DS(ON)} \leq 60m\Omega$  ( 36m $\Omega$  Typ.)  
@ $V_{GS}=2.5V$

### APPLICATIONS

- Load/Power Switching
- Interfacing Switching

### MARKING

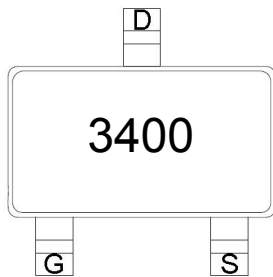

Other mark: "R0"

### SOT-23

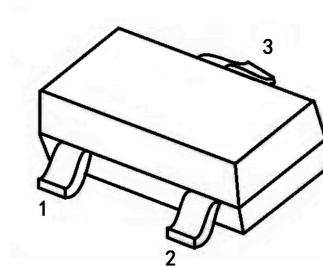

1. GATE
2. SOURCE
3. DRAIN

### N-CHANNEL MOSFET

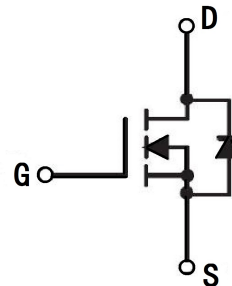

### MAXIMUM RATINGS (Ta=25°C unless otherwise noted)

Symbol	Parameter	Max.	Units
$V_{DSS}$	Drain-Source Voltage	30	V
$V_{GSS}$	Gate-Source Voltage	$\pm 12$	V
$I_D$	Continuous Drain Current	5.8	A
$I_{DM}$	Pulsed Drain Current <sup>note1</sup>	30	A
$P_D$	Power Dissipation	0.35	W
$R_{\theta JA}$	Thermal Resistance, Junction to Ambient	357	$^{\circ}C/W$
$T_J$	Operating and Storage Temperature Range	150	$^{\circ}C$
$T_{STG}$	Operating and Storage Temperature Range	-55 to +150	$^{\circ}C$

**MOSFET ELECTRICAL CHARACTERISTICS Ta=25 °C unless otherwise specified**

Symbol	Parameter	Test Condition	Min.	Typ.	Max.	Units
<b>Off Characteristic</b>						
$V_{(BR)DSS}$	Drain-Source Breakdown Voltage	$V_{GS} = 0V, I_D = 250\mu A$	30	31.5	-	V
$I_{DSS}$	Zero Gate Voltage Drain Current	$V_{DS} = 30V,$ $V_{GS} = 0V, T_J = 25^\circ C$	-	-	1	$\mu A$
$I_{GSS}$	Gate to Body Leakage Current	$V_{GS} = \pm 12V, V_{DS} = 0V$	-	-	$\pm 100$	nA
<b>On Characteristics</b>						
$V_{GS(th)}$	Gate Threshold Voltage	$V_{DS} = V_{GS}, I_D = 250\mu A$	0.7	1	1.4	V
$R_{DS(on)}$	Static Drain-Source On-Resistance <small>note2</small>	$V_{GS} = 10V, I_D = 5A$	-	21	33	m $\Omega$
		$V_{GS} = 4.5V, I_D = 4A$	-	25	39	
		$V_{GS} = 2.5V, I_D = 3A$	-	36	60	
<b>Dynamic Characteristics</b>						
$C_{iss}$	Input Capacitance	$V_{DS} = 15V, V_{GS} = 0V,$ $f = 1.0MHz$	-	-	1155	pF
$C_{oss}$	Output Capacitance		-	108	-	pF
$C_{rss}$	Reverse Transfer Capacitance		-	84	-	pF
$Q_g$	Total Gate Charge	$V_{DS} = 15V, I_D = 5.8A,$ $V_{GS} = 4.5V, f = 1.0MHz$	-	10	-	nC
$Q_{gs}$	Gate-Source Charge		-	1.6	-	nC
$Q_{gd}$	Gate-Drain("Miller") Charge		-	3.1	-	nC
<b>Switching Characteristics</b>						
$t_{d(on)}$	Turn-On Delay Time	$V_{GS} = 10V, V_{DS} = 15V,$ $R_L = 2.7\Omega, R_{GEN} = 3\Omega$	-	-	5	ns
$t_r$	Turn-On Rise Time		-	-	7	ns
$t_{d(off)}$	Turn-Off Delay Time		-	-	40	ns
$t_f$	Turn-Off Fall Time		-	-	6	ns
<b>Drain-Source Diode Characteristics and Maximum Ratings</b>						
$V_{SD}$	Drain to Source Diode Forward Voltage	$V_{GS} = 0V, I_{SD} = 1A,$ $T_J = 25^\circ C$	-	0.8	1	V

Notes: 1. Pulse Test : Pulse Width < 300 $\mu s$ , Duty Cycle  $\leq 2\%$ .

2. Guaranteed by design, not subject to production testing.

TYPICAL PERFORMANCE CHARACTERISTICS

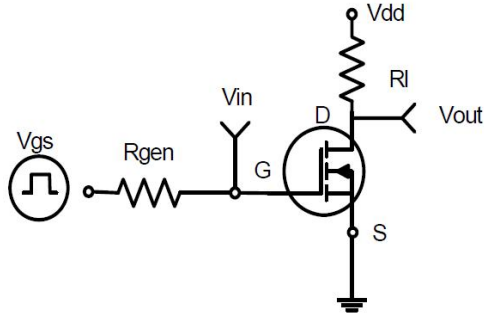

Figure 1: Switching Test Circuit

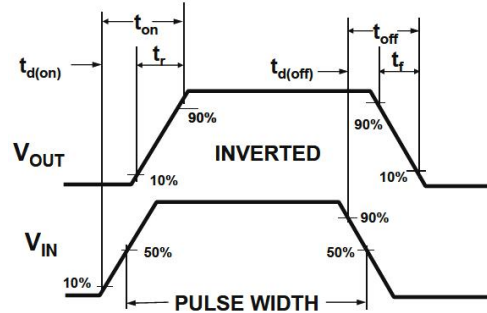

Figure 2: Switching Waveforms

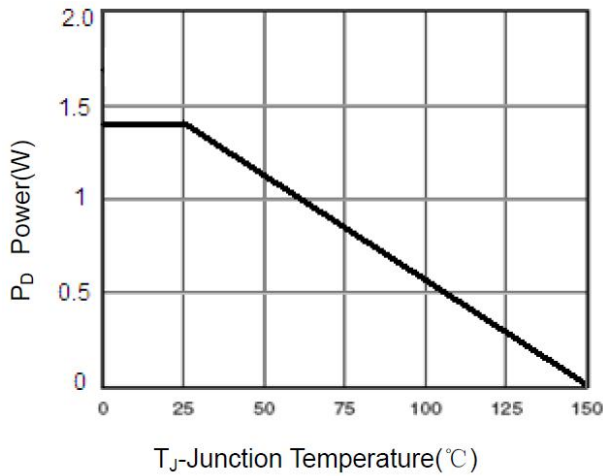

Figure 3 Power Dissipation

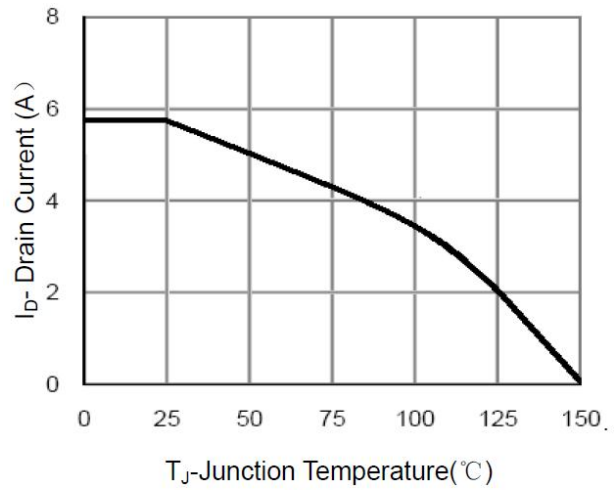

Figure 4 Drain Current

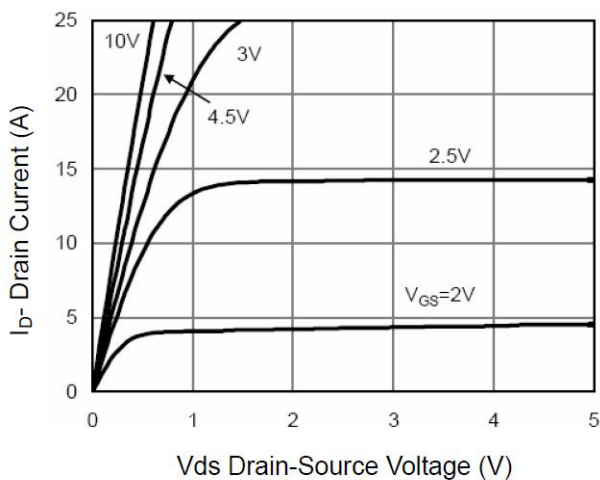

Figure 5 Output Characteristics

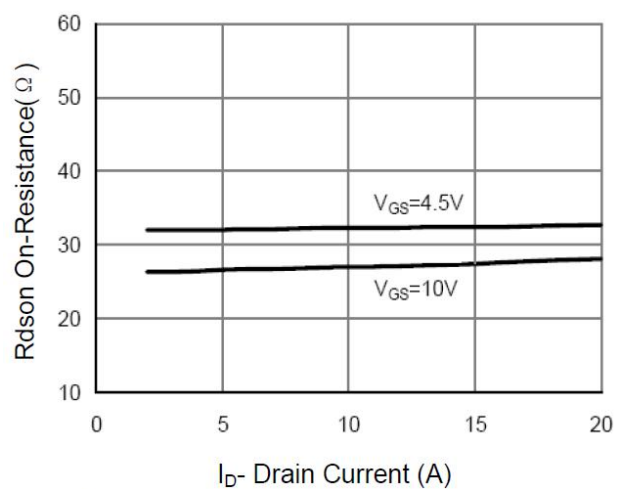

Figure 6 Drain-Source On-Resistance

TYPICAL PERFORMANCE CHARACTERISTICS (cont.)

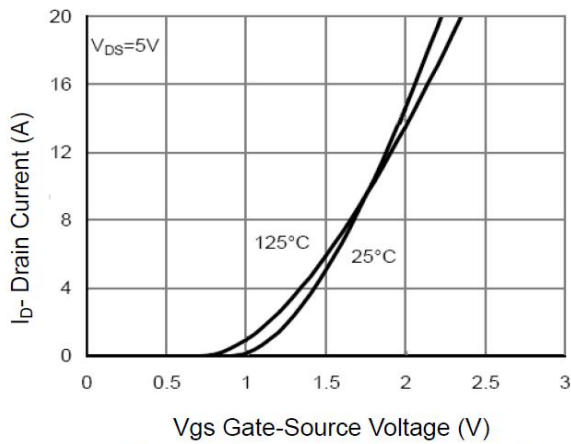

Figure 7 Transfer Characteristics

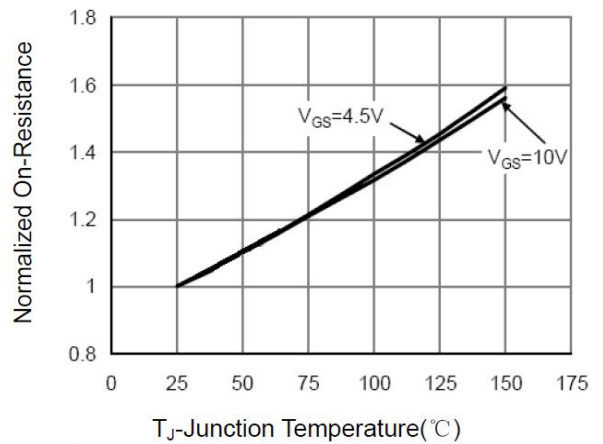

Figure 8 Drain-Source On-Resistance

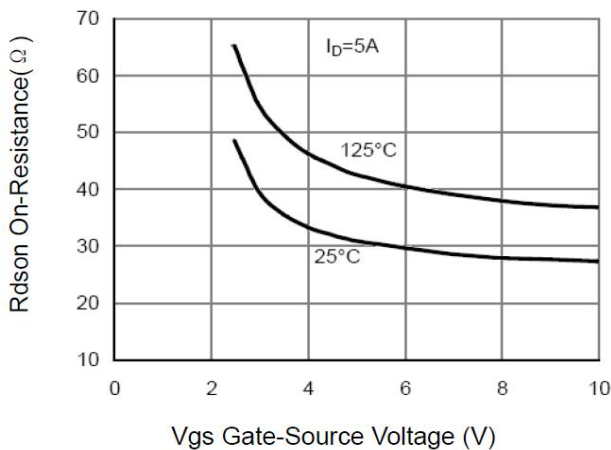

Figure 9 Rdson vs Vgs

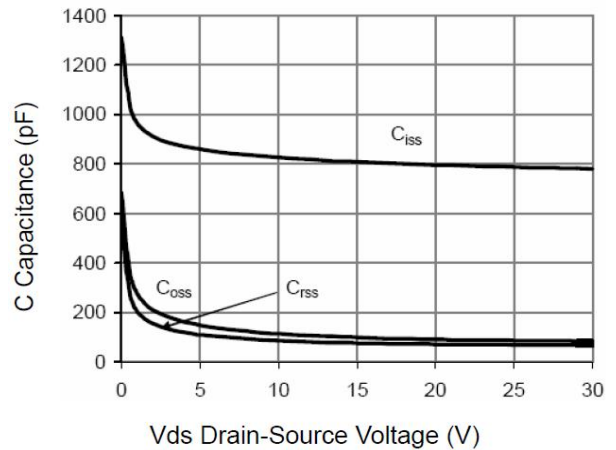

Figure 10 Capacitance vs Vds

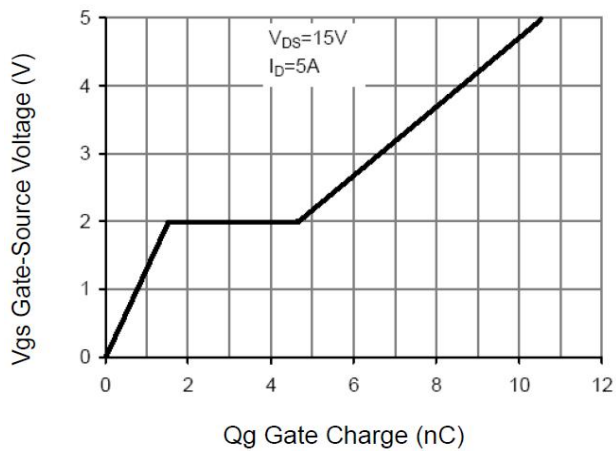

Figure 11 Gate Charge

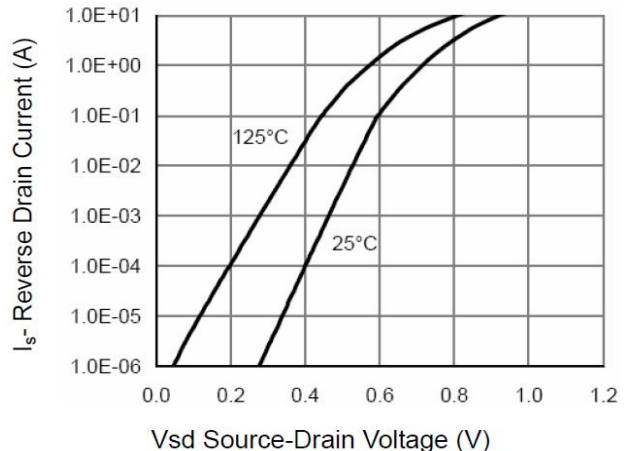
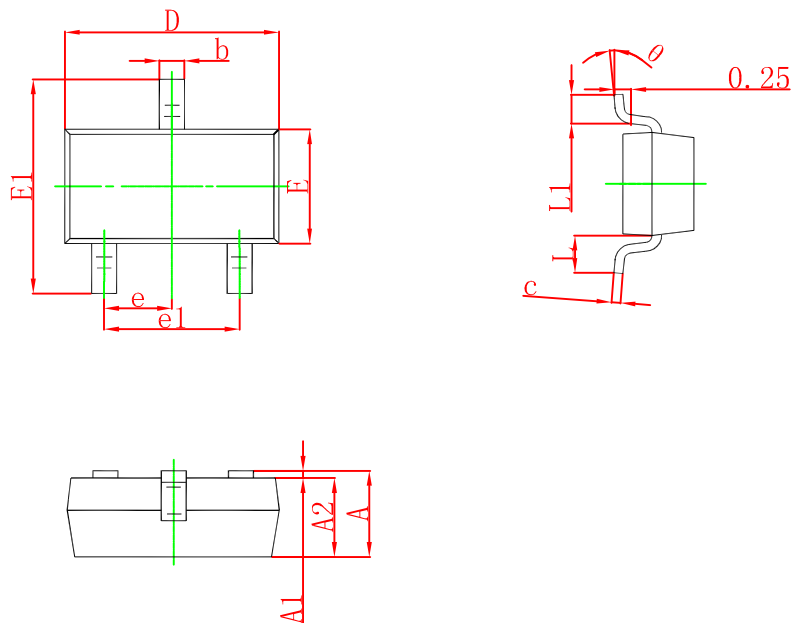

Figure 12 Source- Drain Diode Forward

## SOT-23 PACKAGE OUTLINE DRAWING



Symbol	Dimensions In Millimeters		Dimensions In Inches	
	Min	Max	Min	Max
A	0.900	1.150	0.035	0.045
A1	0.000	0.100	0.000	0.004
A2	0.900	1.050	0.035	0.041
b	0.300	0.500	0.012	0.020
c	0.080	0.150	0.003	0.006
D	2.800	3.000	0.110	0.118
E	1.200	1.400	0.047	0.055
E1	2.250	2.550	0.089	0.100
e	0.950 TYP		0.037 TYP	
e1	1.800	2.000	0.071	0.079
L	0.550 REF		0.022 REF	
L1	0.300	0.500	0.012	0.020
$\theta$	0°	8°	0°	8°