

连接器规格符合性
Connector specification compliance

Describe 描述
SMA 母头连接电缆
SMA female connector cable

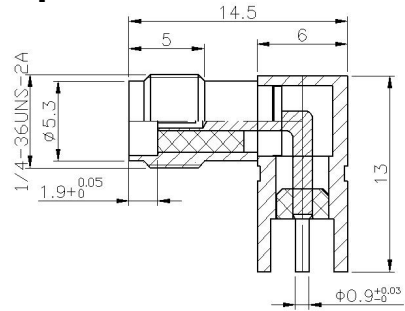

1. Electrical Performance

Parameter	Value
Article No.型号	ZC8.849KK
Frequency range 频率范围	DC ~3GHz
Impedance 特性阻抗	50Ω
VSWR 电压驻波比	≤1.30
Withstanding Voltage 耐压	1500V
Insulation resistance 绝缘电阻	5000MΩ
Connector Type 接口	SMA female interface
Standard 引用标准	IEC60169-4

2. Mechanical Performance

Parameter	Value
Waterproof degree防水等级	NO
Moisture resistance抗湿性	NO
Mating cycles插拔次数	≥500

3. Environment Performance

Parameter	Value
Operating temperature range 工作温度	-65℃ ~+165℃
Storage temperature range 储存温度	-30℃ ~+60℃

4. Material &Plating

Connector parts	Material	Plating
Center conductor中心导体	Brass	Silver镀金
Outer conductor外导体	Brass	Silver镀金
Dielectric介质	PTFE	/
Salt Mist盐雾		48H (0.03 μ)

5. Packing

Standard 包装要求	100pc/plastic bag in separate carton
---------------	--------------------------------------

Remark: Dimensions are in mm with tolerance of ±2%.