

## Small Signal Schottky Diode

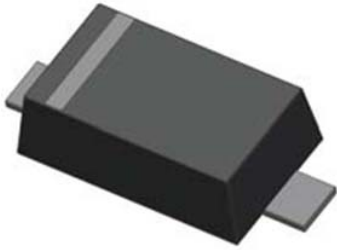

### Features

- $V_R$  40V
- $I_{FM}$  200mA

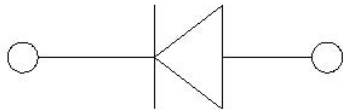

### Mechanical Data

- **Package:** SOD523
- **Terminals:** Tin plated leads, solderable per J-STD-002 and JESD22-B102
- **Polarity:** Cathode line denotes the cathode end
- **Marking:** S

### ■ Maximum Ratings (Ta=25°C Unless otherwise specified)

PARAMETER	SYMBOL	UNIT	Conditions	VALUE
Reverse voltage	$V_R$	V	$I_R=10\mu A$	40
Forward continuous current	$I_{FM}$	mA	$T_a=25^\circ C$	200
Non-repetitive Peak Forward Surge Current	$I_{FSM}$	A	$t=8.3ms$ , Half sine-wave	1
Power dissipation	$P_D$	mW		150
Junction temperature	$T_j$	°C		150
Storage temperature range	$T_{stg}$	°C		-40 to +150
Thermal Resistance From Junction To Ambient	$R_{\theta JA}$	°C /W		667

### ■ Electrical Characteristics (Ta=25°C Unless otherwise specified)

PARAMETER	SYMBOL	UNIT	Conditions	Min	Max
Maximum Forward voltage	$V_F$	V	$I_F=200mA$		0.59
Maximum Reverse current	$I_R$	$\mu A$	$V_R=30V$		5
Minimum Breakdown voltage	$V_R$	V	$I_R=100\mu A$	40	

### ■ Ordering Information (Example)

PREFERRED P/N	PACKING CODE	UNIT WEIGHT(g)	MINIMUM PACKAGE(pcs)	INNER BOX QUANTITY(pcs)	OUTER CARTON QUANTITY(pcs)	DELIVERY MODE
RB521S-40	F2	Approximate 0.002	8000	80000	320000	7" reel



# RB521S-40

## ■ Characteristics (Typical)

Forward Characteristics

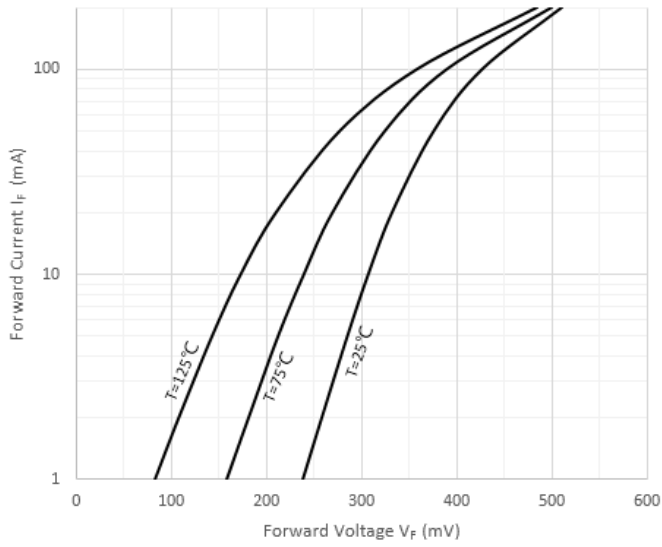

Reverse Characteristics

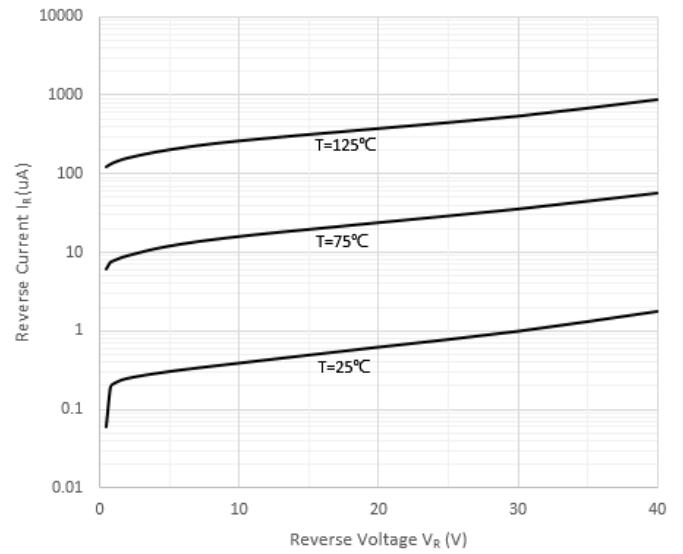

Capacitance Characteristics

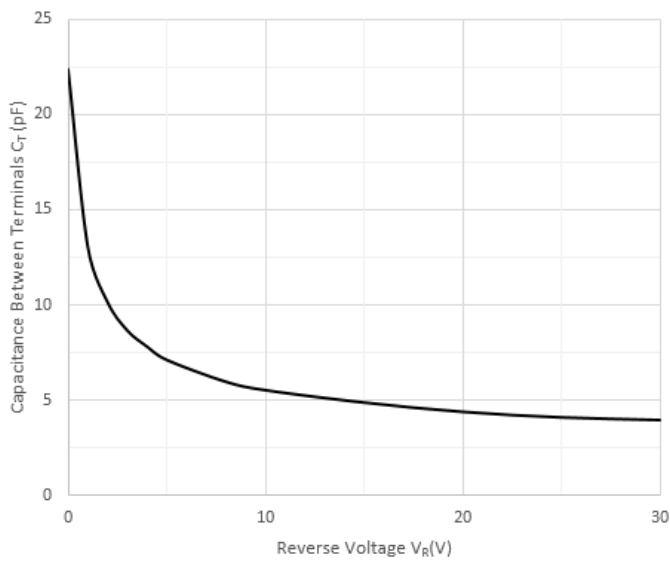

## ■ SOD-523 Package Outline Dimensions

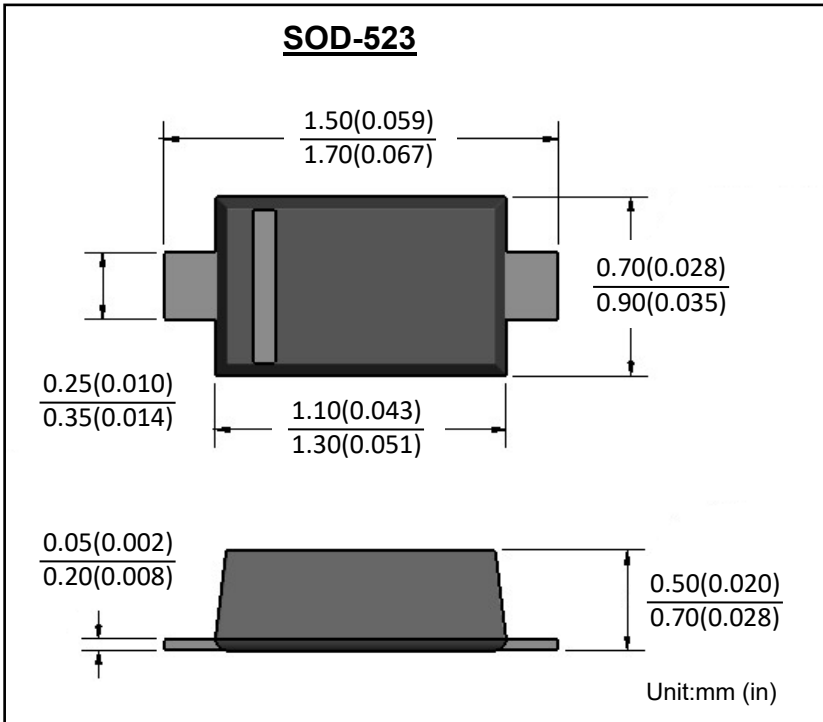

## ■ SOD-523 Soldering Footprint

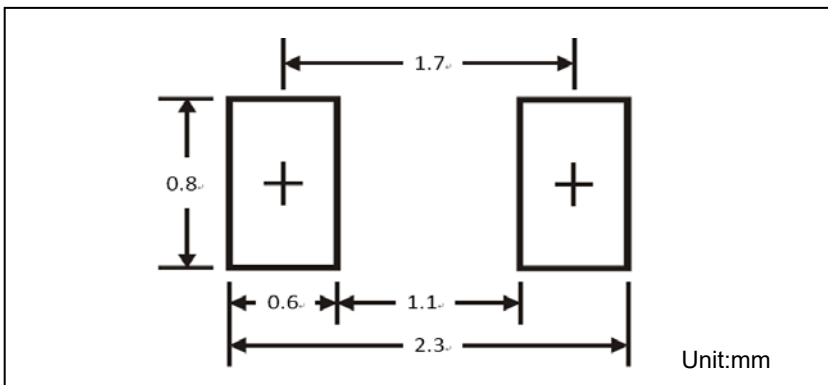



## RB521S-40

---

### Disclaimer

The information presented in this document is for reference only. Yangzhou Yangjie Electronic Technology Co., Ltd. reserves the right to make changes without notice for the specification of the products displayed herein to improve reliability, function or design or otherwise.

The product listed herein is designed to be used with ordinary electronic equipment or devices, and not designed to be used with equipment or devices which require high level of reliability and the malfunction of which would directly endanger human life (such as medical instruments, transportation equipment, aerospace machinery, nuclear-reactor controllers, fuel controllers and other safety devices), Yangjie or anyone on its behalf, assumes no responsibility or liability for any damages resulting from such improper use of sale.

This publication supersedes & replaces all information previously supplied. For additional information, please visit our website [http:// www.21yangjie.com](http://www.21yangjie.com) , or consult your nearest Yangjie's sales office for further assistance.