

P-Channel Enhancement Mode Field Effect Transistor

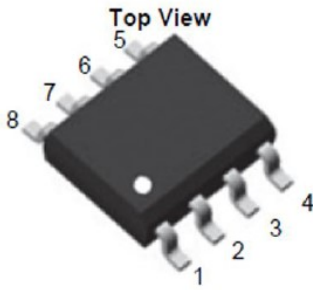

SOP-8

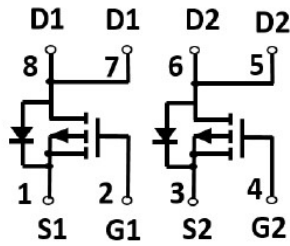
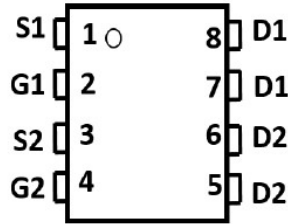

Product Summary

- V_{DS} -30V
- I_D -5.1A
- $R_{DS(ON)}$ (at $V_{GS}=-10V$) <43mohm
- $R_{DS(ON)}$ (at $V_{GS}=-4.5V$) <59mohm
- 100% ∇V_{DS} Tested

General Description

- Trench Power LV MOSFET technology
- High density cell design for low $R_{DS(ON)}$
- High Speed switching

Applications

- Battery protection
- Load switching
- Power management

■ Absolute Maximum Ratings ($T_A=25^\circ\text{C}$ unless otherwise noted)

Parameter	Symbol	Limit	Unit
Drain-source Voltage	V_{DS}	-30	V
Gate-source Voltage	V_{GS}	± 20	V
Drain Current	I_D	$T_A=25^\circ\text{C}$	-5.1
		$T_A=70^\circ\text{C}$	-4.1
Pulsed Drain Current ^A	I_{DM}	-20	A
Total Power Dissipation	P_D	$T_A=25^\circ\text{C}$	2.5
		$T_A=70^\circ\text{C}$	1.6
Thermal Resistance Junction-to-Ambient ^B	$R_{\theta JA}$	50	$^\circ\text{C}/\text{W}$
Junction and Storage Temperature Range	T_J, T_{STG}	-55~+150	$^\circ\text{C}$

■ Ordering Information (Example)

PREFERRED P/N	PACKING CODE	Marking	MINIMUM PACKAGE(pcs)	INNER BOX QUANTITY(pcs)	OUTER CARTON QUANTITY(pcs)	DELIVERY MODE
YJS4953A	F2	Q4953	4000	8000	64000	13" reel



YJS4953A

■ Electrical Characteristics ($T_J=25^\circ\text{C}$ unless otherwise noted)

Parameter	Symbol	Conditions	Min	Typ	Max	Units
Static Parameter						
Drain-Source Breakdown Voltage	BV_{DSS}	$V_{GS}=0V, I_D=-250\mu A$	-30			V
Zero Gate Voltage Drain Current	I_{DSS}	$V_{DS}=-30V, V_{GS}=0V$			-1	μA
Gate-Body Leakage Current	I_{GSS}	$V_{GS}=\pm 20V, V_{DS}=0V$			± 100	nA
Gate Threshold Voltage	$V_{GS(th)}$	$V_{DS}=V_{GS}, I_D=-250\mu A$	-1.0	-1.5	-2.4	V
Static Drain-Source On-Resistance	$R_{DS(on)}$	$V_{GS}=-10V, I_D=-4A$		30	43	m Ω
		$V_{GS}=-4.5V, I_D=-3.5A$		46	59	
Diode Forward Voltage	V_{SD}	$I_S=-4A, V_{GS}=0V$			-1.2	V
Dynamic Parameters						
Input Capacitance	C_{iss}	$V_{DS}=-15V, V_{GS}=0V, f=1\text{MHz}$		719		pF
Output Capacitance	C_{oss}			78		
Reverse Transfer Capacitance	C_{riss}			64		
Switching Parameters						
Total Gate Charge	Q_g	$V_{GS}=-10V, V_{DS}=-15V, I_D=-5.1A$		14.23		nC
Gate-Source Charge	Q_{gs}			3.16		
Gate-Drain Charge	Q_{gd}			2		
Reverse Recovery Charge	Q_{rr}	$I_F=-5.1A, di/dt=100A/\mu s$		5.3		ns
Reverse Recovery Time	t_{rr}			30		
Turn-on Delay Time	$t_{D(on)}$	$V_{GS}=-10V, V_{DS}=-15V, I_D=5.1A$ $R_{GEN}=3\Omega$		7.4		ns
Turn-on Rise Time	t_r			37		
Turn-off Delay Time	$t_{D(off)}$			31.6		
Turn-off fall Time	t_f			42		

A. Pulse Test: Pulse Width $\leq 300\mu s$, Duty cycle $\leq 2\%$.

B. $R_{\theta JA}$ is the sum of the junction-to-case and case-to-ambient thermal resistance, where the case thermal reference is defined as the solder mounting surface of the drain pins. $R_{\theta JC}$ is guaranteed by design, while $R_{\theta JA}$ is determined by the board design. The maximum rating presented here is based on mounting on a 1 in 2 pad of 2oz copper.



■ Typical Performance Characteristics

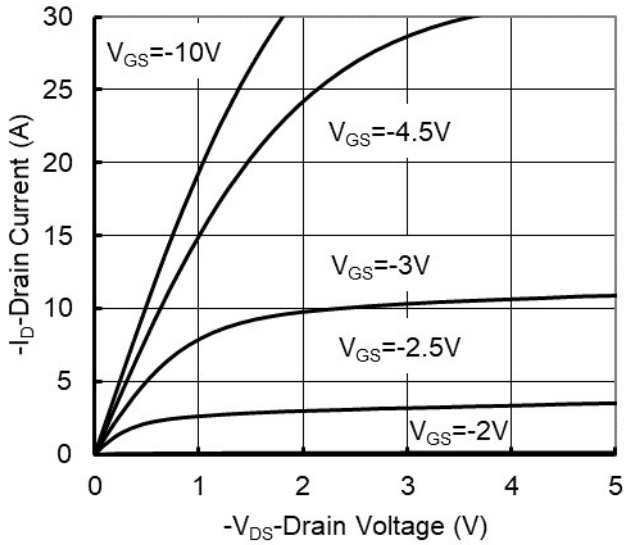

Figure1. Output Characteristics

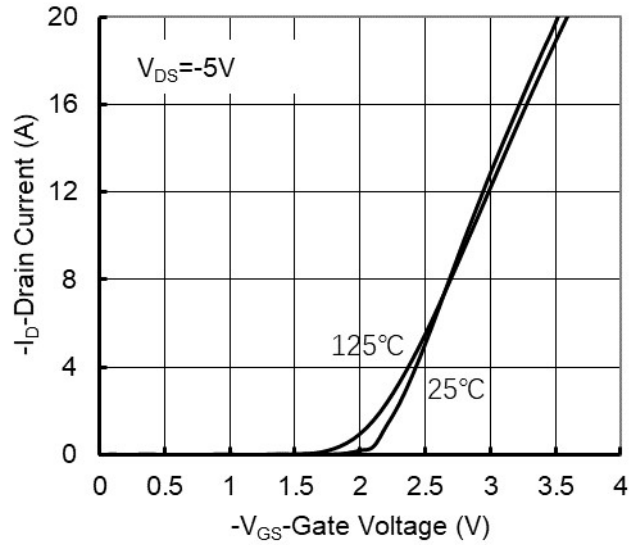

Figure2. Transfer Characteristics

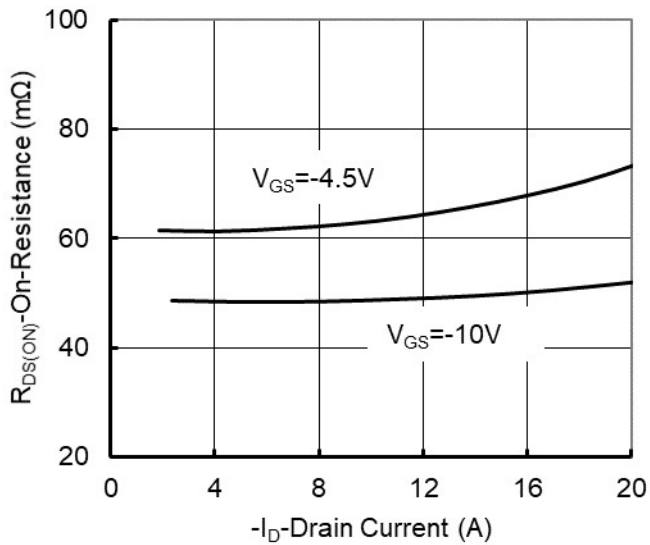

Figure 3: On-Resistance vs. Drain Current and Gate Voltage

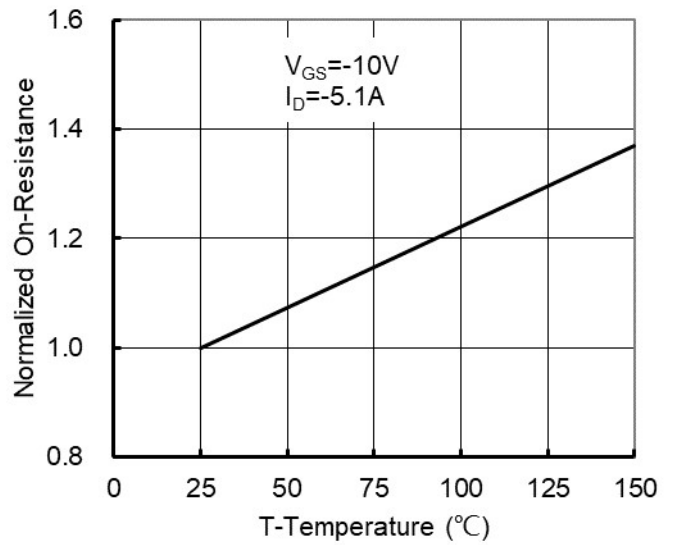

Figure 4: On-Resistance vs. Junction Temperature

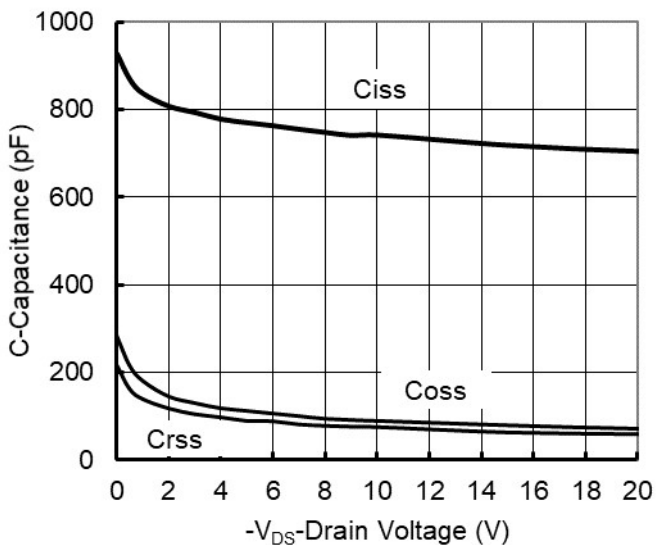

Figure5. Capacitance Characteristics

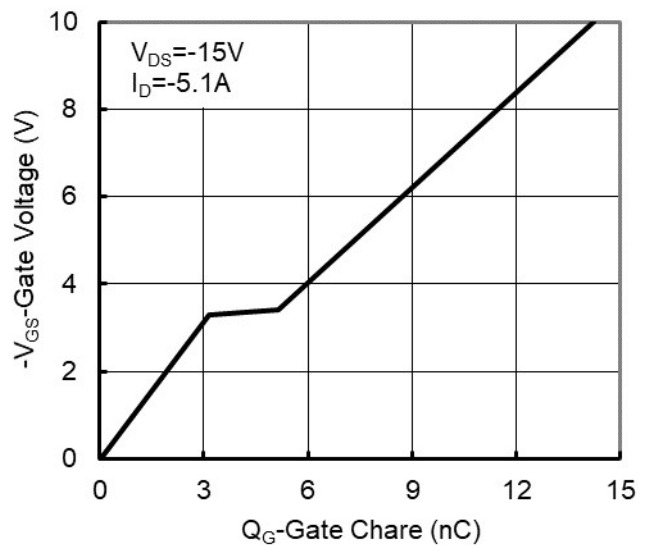

Figure6. Gate Charge

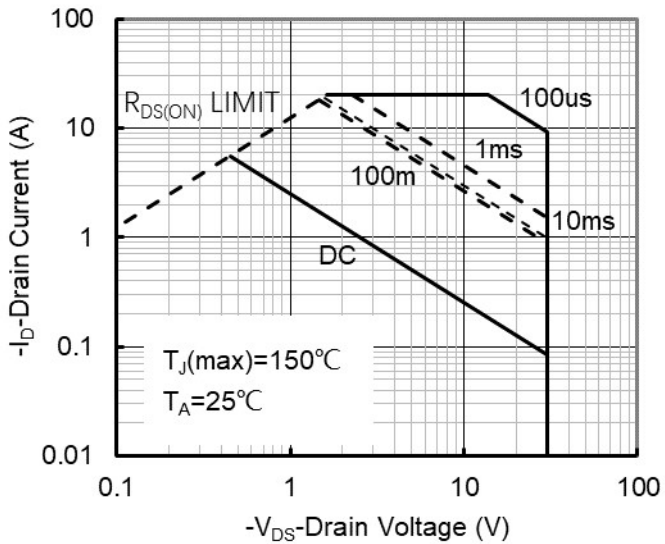

Figure7. Safe Operation Area

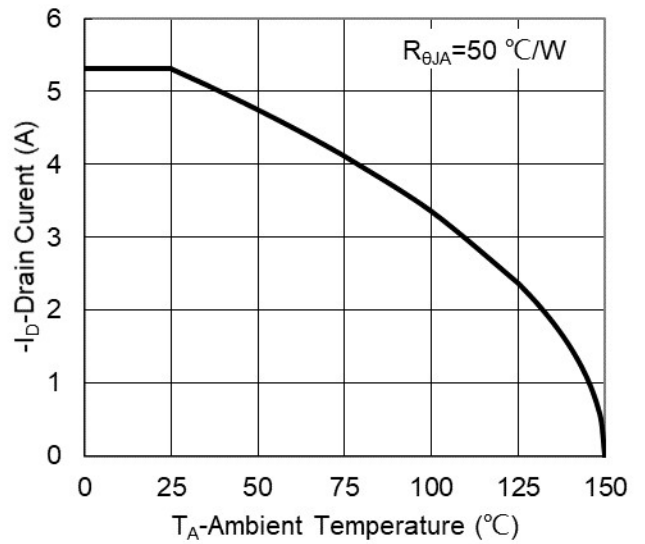

Figure8. Maximum Continuous Drain Current vs Ambient Temperature

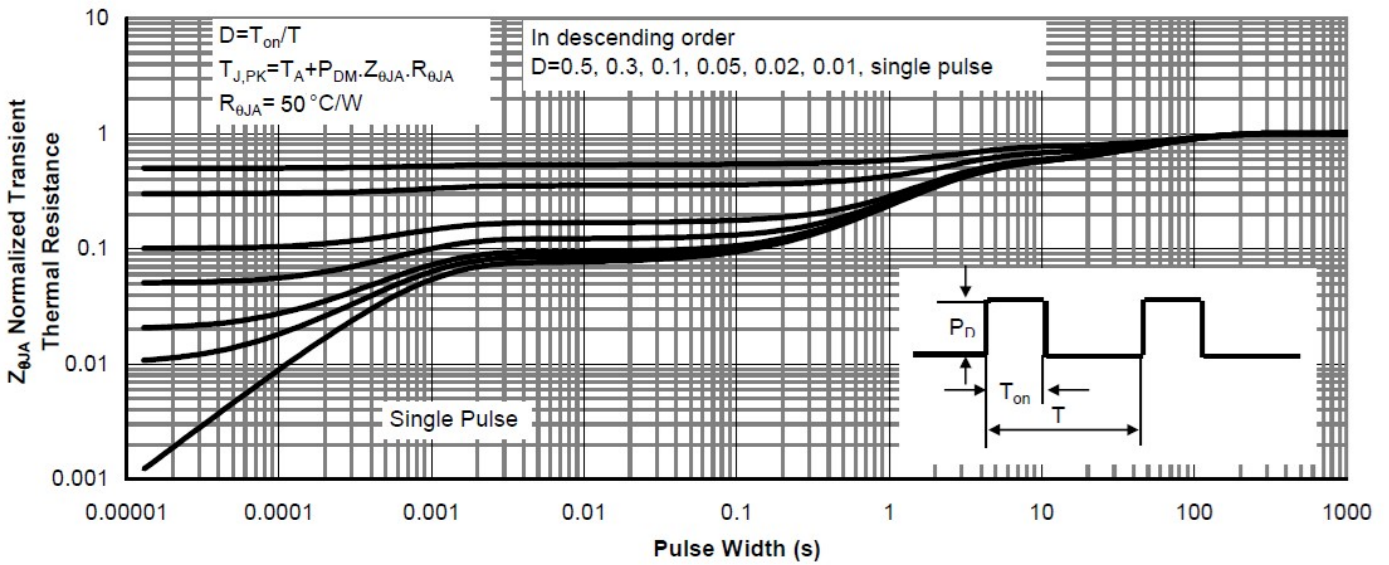

Figure9. Normalized Maximum Transient Thermal Impedance



Resistive Switching Test Circuit & Waveforms



Diode Recovery Test Circuit & Waveforms



Gate Charge Test Circuit & Waveform



Unclamped Inductive Switching (UIS) Test Circuit & Waveforms



YJS4953A

■ SOP-8 Package information

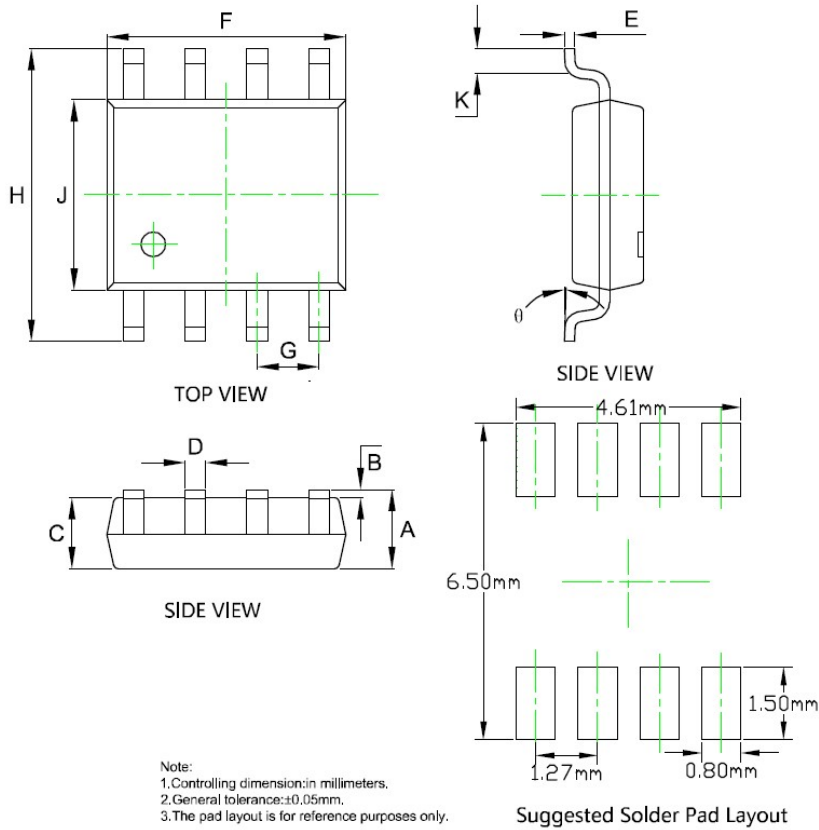

SYMBOL	DIMENSIONS			
	INCHES		Millimeter	
	MIN.	MAX.	MIN.	MAX.
A	0.053	0.069	1.350	1.750
B	0.004	0.010	0.100	0.250
C	0.053	0.061	1.350	1.550
D	0.013	0.020	0.330	0.510
E	0.007	0.010	0.170	0.250
F	0.189	0.197	4.800	5.000
G	0.050BSC		1.270BSC	
H	0.228	0.244	5.800	6.200
J	0.150	0.157	3.800	4.000
K	0.016	0.050	0.400	1.270
θ	0°	8°	0°	8°



Disclaimer

The information presented in this document is for reference only. Yangzhou Yangjie Electronic Technology Co., Ltd. reserves the right to make changes without notice for the specification of the products displayed herein to improve reliability, function or design or otherwise.

The product listed herein is designed to be used with ordinary electronic equipment or devices, and not designed to be used with equipment or devices which require high level of reliability and the malfunction of which would directly endanger human life (such as medical instruments, transportation equipment, aerospace machinery, nuclear-reactor controllers, fuel controllers and other safety devices), Yangjie or anyone on its behalf, assumes no responsibility or liability for any damages resulting from such improper use of sale.

This publication supersedes & replaces all information previously supplied. For additional information, please visit our website [http:// www.21yangjie.com](http://www.21yangjie.com) , or consult your nearest Yangjie's sales office for further assistance.