

YTS-A007-X系列

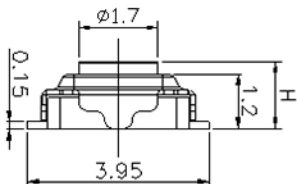

H
1.5
1.7
2.0

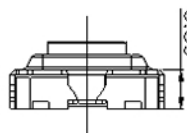
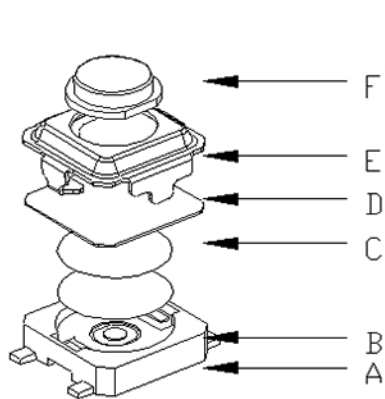
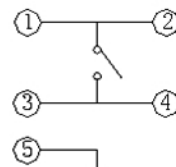

电路图
CIRCUIT DIAGRAM

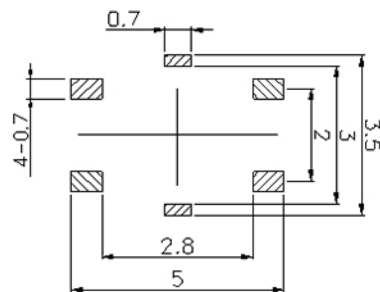

PCB. 焊接图
PCB WELDING DRAWING

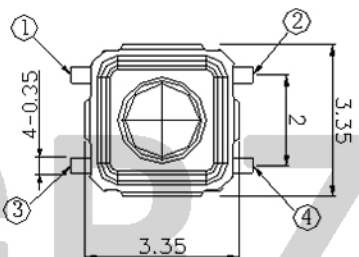
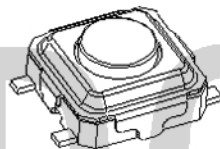

编码表

主要技术参数、性能
The Main Technology Performance

额定电流、电压 Rate voltage, current	50mA DC12V
接触电阻 Contact resistance	≤100mΩ
按力 Operating force	见编码表
行程 travel	0.20±0.10mm
绝缘电阻 Insulated resistance	≥100MΩ
介电强度 Dielectric strength	≥250VAC/1min
寿命 Endurance	≥30000次

YTS	A007	X	XXX	XX	XX	X
开关	型号	等级	高度	克力	另码	包装
		A	015 (1.5mm)	16 (160g)	01~99	A 散装
		B	016 (1.6mm)	18 (180g)		B 冷封编带
		C	017 (1.7mm)	25 (250g)		C 管热
			020 (2.0mm)	30 (300g)		H 热封
			025 (2.5mm)	32 (320g)		
				40 (400g)		

F	E	D	C	B	A	项目 ITEM	名称 DESCRIPTION	材质 MATERIAL	数量 QTY	表面处理/颜色 FINISH/COLOR
							按钮	LCF	1	灰色
							盖板	不锈钢	1	镀银
							防尘膜	聚酰亚胺	1	橙黄色
							弹片	不锈钢	2	镀银
							本体	LCF	1	灰色
							卡件	黄铜	1	镀银

						第一视角 FIRST VIEW		名称/NAME: 轻触开关 TACTILE SWITCH	
						比例 SCALE: 1:1		型号/MODEL: YTS-A007-X系列	
						一般公差 GENERAL TOLERANCE		东莞市博众电气有限公司 DONGGUAN BOZHONG ELECTRIC CO., LTD	
标记 MARK		效期 EFFECTIVE DATE		更改文件号 REVISION		公差 TOLERANCE			
设计 DESIGN		审核 CHECKED		批准 APPROVED		角度 ANGLE			

日期 DATE	2017.05.17
日期 DATE	2017.05.17
日期 DATE	2017.05.17
公差 TOLERANCE	0.5~2 ±0.10
公差 TOLERANCE	2~5 ±0.15
公差 TOLERANCE	5~10 ±0.20
角度 ANGLE	±0.5°