

SPECIFICATION FOR APPROVAL

REF. :

PROD. NAME	SMD Power Inductor	ABC'S DWG NO.	SR0805□□□□L□-□□□		
		REV.	20160712-H	PAGE	1

I . Configuration and dimensions :

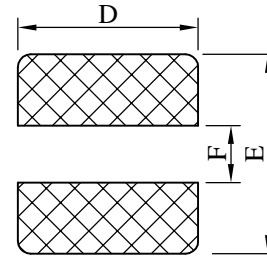
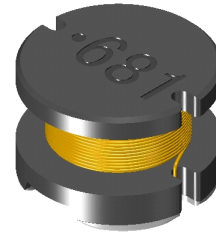
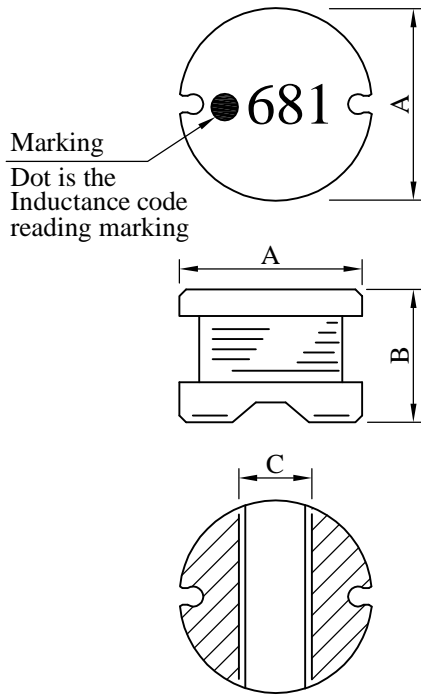

(PCB Pattern)

Unit : m/m

A	B	C	D	E	F
7.50 ±0.3	5.00 ±0.3	2.60 ref.	8.00 ref.	7.80 ref.	2.40 ref.

II . Description :

- a . Ferrite drum core construction.
- b . Enamelled copper wire : F 、 H class
- c . Product weight : 0.810g (ref.)
- d . Moisture sensitivity Level I
- e . Products comply with RoHS' requirements
- f . Halogen free available

Peak Temp : 250°C max.
Max. Peak Temp - 5°C : 30sec max.
Max time above 217°C : 60sec~150sec max.

III . General specification :

- a . Storage temp. : -40°C ----+125°C
- b . Operating temp. : -40°C ----+125°C
(Temp. rise included)
- c . Resistance to solder heat : 250°C .10 secs.

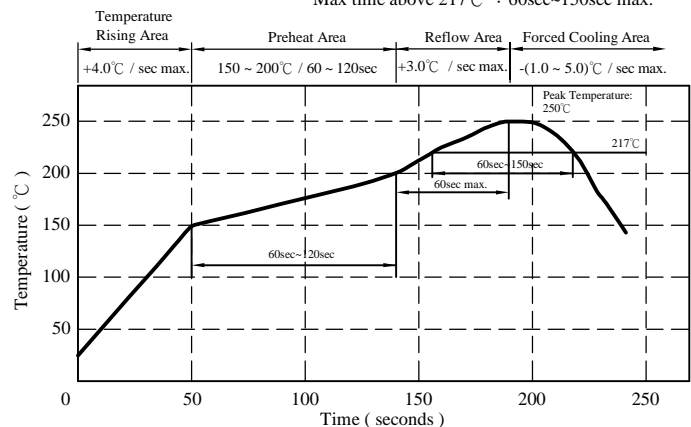

AR-001C

SPECIFICATION FOR APPROVAL

REF. :

PROD. NAME	SMD Power Inductor	ABC'S DWG NO.	SR0805□□□□L□-□□□		
		REV.	20160712-H	PAGE	2

IV . Electrical characteristics :

DWG No.	Inductance (μH)	Q ref.	Test Freq. (Hz)		SRF (MHz) nom.	RDC (Ω) max.	Isat (A) typ.	Irms (A) typ.
			L	Q				
SR08051R5ML□-□□□	1.5±20%	32	1k / 1V	7.960M	120.0	0.015	10.500	7.200
SR08052R5ML□-□□□	2.5±20%	32	1k / 1V	7.960M	70.0	0.020	8.200	5.900
SR08053R3ML□-□□□	3.3±20%	32	1k / 1V	7.960M	55.0	0.022	7.300	5.600
SR08053R9ML□-□□□	3.9±20%	32	1k / 1V	7.960M	45.0	0.024	6.500	5.200
SR08054R7ML□-□□□	4.7±20%	31	1k / 1V	7.960M	38.0	0.033	6.000	4.200
SR08055R6ML□-□□□	5.6±20%	31	1k / 1V	7.960M	34.0	0.035	5.500	4.000
SR08056R8ML□-□□□	6.8±20%	30	1k / 1V	7.960M	33.0	0.040	4.800	3.600
SR08058R2ML□-□□□	8.2±20%	29	1k / 1V	7.960M	30.0	0.050	4.300	3.400
SR0805100ML□-□□□	10.0±20%	25	1k / 1V	2.520M	22.0	0.070	4.000	3.000
SR0805120ML□-□□□	12.0±20%	25	1k / 1V	2.520M	20.0	0.080	3.700	2.750
SR0805150ML□-□□□	15.0±20%	25	1k / 1V	2.520M	16.0	0.090	3.200	2.600
SR0805180ML□-□□□	18.0±20%	20	1k / 1V	2.520M	15.0	0.100	3.000	2.500
SR0805220ML□-□□□	22.0±20%	20	1k / 1V	2.520M	13.0	0.110	2.700	2.300
SR0805270ML□-□□□	27.0±20%	20	1k / 1V	2.520M	12.0	0.120	2.500	2.200
SR0805330KL□-□□□	33.0±10%	15	1k / 1V	2.520M	10.0	0.140	2.200	2.000
SR0805390KL□-□□□	39.0±10%	15	1k / 1V	2.520M	9.5	0.160	2.000	1.900
SR0805470KL□-□□□	47.0±10%	15	1k / 1V	2.520M	9.0	0.200	1.900	1.650
SR0805560KL□-□□□	56.0±10%	15	1k / 1V	2.520M	8.5	0.240	1.700	1.500
SR0805680KL□-□□□	68.0±10%	15	1k / 1V	2.520M	8.0	0.300	1.500	1.350
SR0805820KL□-□□□	82.0±10%	12	1k / 1V	2.520M	7.0	0.370	1.400	1.250
SR0805101KL□-□□□	100.0±10%	12	1k / 1V	0.796M	6.5	0.450	1.250	1.050
SR0805121KL□-□□□	120.0±10%	12	1k / 1V	0.796M	5.6	0.480	1.150	1.000
SR0805151KL□-□□□	150.0±10%	12	1k / 1V	0.796M	5.5	0.680	1.000	0.850
SR0805181KL□-□□□	180.0±10%	12	1k / 1V	0.796M	5.0	0.770	0.900	0.700
SR0805221KL□-□□□	220.0±10%	12	1k / 1V	0.796M	4.8	0.960	0.850	0.630
SR0805271KL□-□□□	270.0±10%	12	1k / 1V	0.796M	4.5	1.110	0.750	0.600
SR0805331KL□-□□□	330.0±10%	12	1k / 1V	0.796M	4.3	1.260	0.700	0.560
SR0805391KL□-□□□	390.0±10%	12	1k / 1V	0.796M	4.0	1.770	0.650	0.500
SR0805471KL□-□□□	470.0±10%	12	1k / 1V	0.796M	3.8	1.960	0.600	0.480
SR0805561KL□-□□□	560.0±10%	30	1k / 1V	0.796M	3.7	2.500	0.550	0.420
SR0805681KL□-□□□	680.0±10%	29	1k / 1V	0.796M	3.5	2.800	0.480	0.380
SR0805821KL□-□□□	820.0±10%	28	1k / 1V	0.796M	3.2	4.000	0.450	0.320
SR0805102KL□-□□□	1000.0±10%	27	1k / 1V	0.252M	3.0	4.500	0.400	0.300
SR0805122KL□-□□□	1200.0±10%	28	1k / 1V	0.252M	2.6	6.800	0.370	0.230
SR0805152KL□-□□□	1500.0±10%	27	1k / 1V	0.252M	2.4	8.000	0.330	0.220
SR0805182KL□-□□□	1800.0±10%	30	1k / 1V	0.252M	1.6	9.200	0.300	0.210
SR0805222KL□-□□□	2200.0±10%	29	1k / 1V	0.252M	1.5	10.000	0.270	0.200
SR0805272KL□-□□□	2700.0±10%	31	1k / 1V	0.252M	1.4	11.800	0.250	0.190
SR0805332KL□-□□□	3300.0±10%	28	1k / 1V	0.252M	1.2	16.500	0.220	0.170
SR0805392KL□-□□□	3900.0±10%	28	1k / 1V	0.252M	1.1	18.000	0.210	0.160
SR0805472KL□-□□□	4700.0±10%	30	1k / 1V	0.252M	1.0	21.000	0.190	0.150

- | | |
|--|---|
| 1). □ : Packaging information : □ Code | 4). Isat base on $\Delta L / L0A=10\%$ typ. |
| 2). "-□□□" : Reference code | (Approximately transient current) |
| 3). Electrical specifications at 25°C | 5). Irms base on Temp. rise 40°C typ. |

AR-001C



SPECIFICATION FOR APPROVAL

REF. :

PROD. NAME	SMD Power Inductor	ABC'S DWG NO.	SR0805□□□□L□-□□□		
		REV.	20160712-H	PAGE	3

V . Curve :

SR08051R5ML□

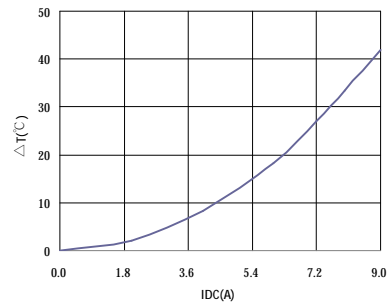
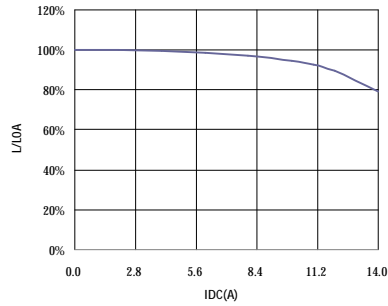

SR0805100ML□

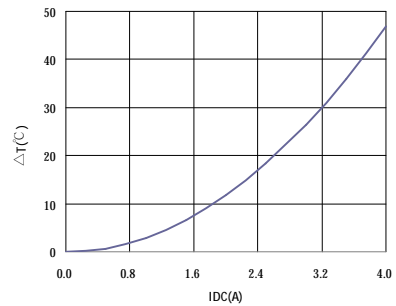
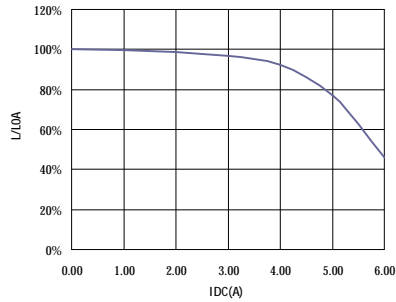

SR0805820KL□

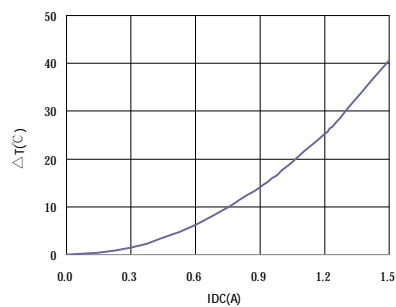
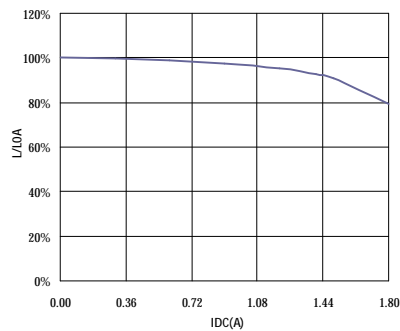

SR0805472KL□

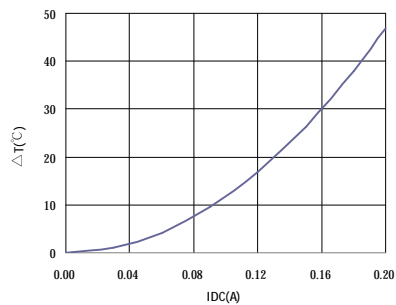
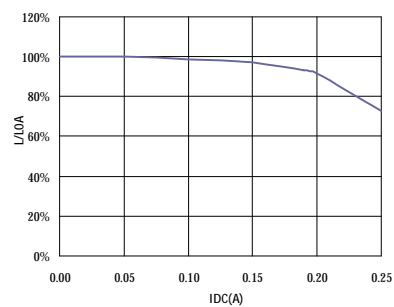

AR-001C

SPECIFICATION FOR APPROVAL

REF. :

PROD. NAME	SMD Power Inductor	ABC'S DWG NO.	SR0805□□□□L□-□□□		
		REV.	20160712-H	PAGE	4

VI . Packaging information :

(1) Configuration

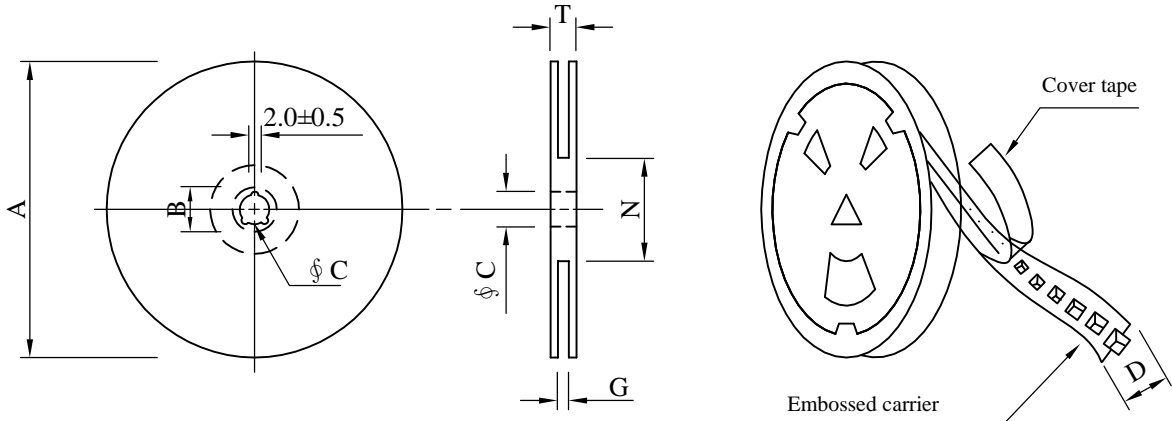

※Carrier tape width : D

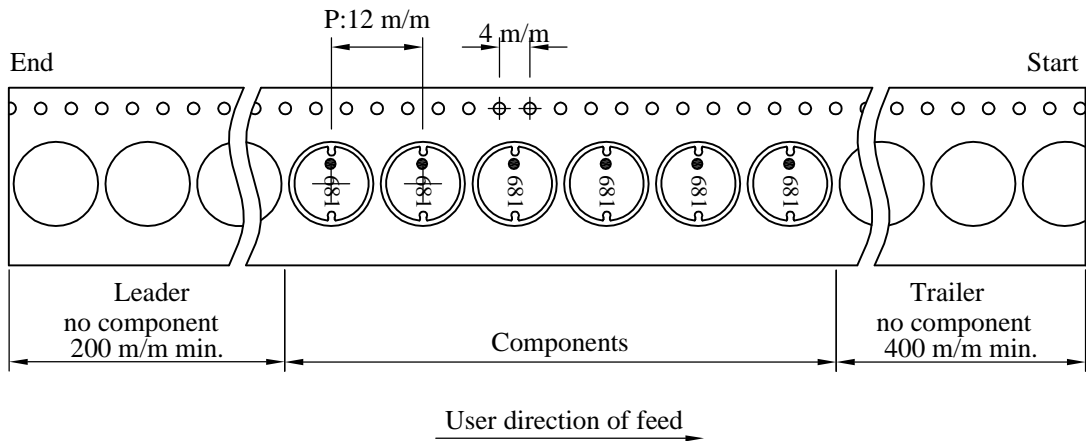

(2) Dimensions

Unit:m/m

Style	A	B	C	D	G	N	T
13 - 16	330	21±0.8	13±0.5	16	18 ⁺⁰	50 ⁻⁰	22.4

(3) Q'TY & G.W. Per package

Code	Inner : Reel			Outer : Carton		
	Q'TY (pcs)	G.W. (gw)	Style	Q'TY (pcs)	G.W. (Kg)	SIZE (cm)
B 、 C	1,000	1290	13 - 16	6,000	9.0	38 x 37 x 22
D	500	860	13 - 16	3,000	6.4	38 x 37 x 22

AR-001C

SPECIFICATION FOR APPROVAL

REF. :

PROD. NAME	SMD Power Inductor	ABC'S DWG NO.	SR0805□□□□L□-□□□		
		REV.	20160712-H	PAGE	5

VII . Dwging number expression :

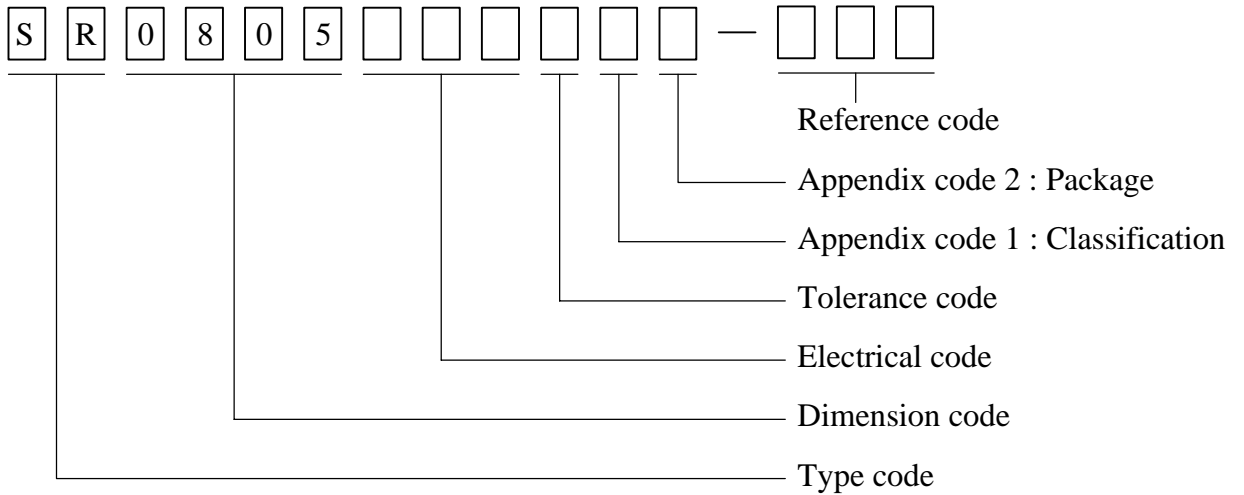

Appendix code 1 : Product Classification

Appendix code 2 : Package Information

Code	Inner package	Cover tape	Carrier tape	Bag	Package Q'TY	Remark
B	T /R (Reel package)	UCT	Antistatic	Antistatic	1000 pcs	
C	T /R (Reel package)	UCT	Antistatic	Antistatic	1000 pcs	
D	T /R (Reel package)	UCT	Antistatic	Antistatic	500 pcs	

AR-001C

SPECIFICATION FOR APPROVAL

REF. :

PROD. NAME	SMD Power Inductor	ABC'S DWG NO.	SR0805□□□□L□-□□□		
		REV.	20160712-H	PAGE	6

VIII . Reliability test :

Item	Reference documents	Test Condition	Test Specification
1.High Temperature Exposure	MIL-STD-202 Method 108	1.Temperature: 125±2℃ 2.Time:96±2 hours.	1.No mechanical or electrical damage. 2.Inductance shall not change more than ±10%.
2.Temperature Cycling	JESD22-A 104	1.Temperature: -40℃ ~ +125℃ 2.Number of cycle:100 cycle 3.Dwell time:30 minutes	1.No mechanical or electrical damage. 2.Inductance shall not change more than ±10%.
3.Biased Humidity Test	MIL-STD-202 Method 103	1.Temperature : 85±2 ℃ 2.Humidity: 85% RH. 3.Time:96±2 Hours	1.No mechanical or electrical damage. 2.Inductance shall not change more than ±10%.
4.Operational Life	JESD22-A 108	1.Temperature: 125℃ (Temp. rise included) 2.Time:96±2 hours. 3.Rated current	1.No mechanical or electrical damage. 2.Inductance shall not change more than ±10%.
5.External Visual	JESD22-B 101 & MIL-STD-883 Method 2009	Inspect product constructions, marking and workmanship.	1.No pollution on the surface of products. 2.Clear marking. 3.No crack.
6.Physical Dimensions	JESD22-B 100	Verify physical dimensions to the applicable product detail specification.	Per product specification standard
7.Resistance to solvents	MIL-STD-202 Method 215	Immerse into solvent for 3±0.5 minutes & brush 10 times for 3 cycles.	1.No body change in apperance. 2.No marking blurred. 3.Inductance shall not change more than ±10%.
8.Vibration Test	MIL-STD-202 Method 204	1.Frequency and Amplitud : 10-2000-10 Hz, 1.5 mm. 2.Direction:X, Y, Z 3.Test duration:2 hours for each direction, 6 hours in total.	1.No mechanical or electrical damage. 2.Inductance shall not change more than ±10%.
9.Resistance To Soldering Heat Test	MIL-STD-202 Method 210 & J-STD020D.1	1.Highest temperature : 250±5℃. 2.Time (temp. ≥ 217℃) : 60~150 Seconds. 3.IR reflow times : 3 times.	1.No mechanical or electrical damage. 2.Inductance shall not change more than ±10%.
10.Saturation Current	JIS C 6436 & User SPEC.	1.Applied rated current for 5 seconds. 2.Saturation current	Inductance shall not drop more than 10% typ.
11.Over load	JIS C 6436 & User SPEC.	1.Applied one and half rated current for a period of 5 minutes. 2.Rated current	No electrical or mechanical damage
12.Temperature Rise Current	JIS C 6436 & User SPEC.	1.Applied rated current for 10 minutes. 2.Temperature measure by digital surface thermometer. 3.Irms current	Surface temperature rise is less than 40℃ typ.
13.Solderability Test	J-STD-002 & JESD22-B 102	1.Baking in pre-testing : 150±5℃ / 16Hours±30 min. 2.Peak temperature : 240±5℃ 3.Time (temp. ≥ 217℃) : 60~150 seconds. 4.IR reflow times : 1 time.	More than 95% soldering coverage min on terminations.
14.Electrical Characteriazation	MIL-STD-202 Method 304 & User SPEC.	1.Operating temperature : -40℃~125℃ 2.Room temperature : 25℃.	1.No mechanical or electrical damage. 2.Inductance shall not change more than ±10%.
15.Drop	CNS-C6354 & GB/T 2423.8	1.Products shall be mounted on SPEC. pcb and dropped down from a heigh of 1m 2.Drop total time : 6 times (Every side ofsample drop 2 times)	1. Adhesion on PCB shall be enough. 2. Product appearance shall not break. 3. No electrical damage.
16.Terminal Strength Test	IEC 60068-2-21	1.Apply push force to samples mounted on PCB. 2.Force of 1.8 kg for 60±1 seconds.	After test, inductors shall be no mechanical damage.

AR-001C

SPECIFICATION FOR APPROVAL

REF. :

PROD. NAME	SMD Power Inductor	ABC'S DWG NO.	SR0805□□□□L□-□□□		
		REV.	20160712-H	PAGE	7

IX . Change history :

DATE/REV.	DISCRIPTION	DRAWN	CHECKED	APPROVED
20080801-A	Released	Miz Hsieh	Nick Chen	Nick Chen
20090505-B	Add package code D			
20100629-C	Delete the words" Dot is start winding "			
20111014-D	Add the words "Dot is the inductance code reading marking"			
20121002-E	Modify the specification form			
20140418-F	Add current curve			
20150507-G	Modify the Reliability test and the Package weight			
20160712-H	1. Upgrade the current specification 2. Change the current curve format 3. Add Change history and Dwging number expression	Miz Hsieh	Nick Chen	Nick Chen

AR-001C