

Chip Ferrite Bead BLM18□□□□□□Z1D Murata Standard Reference Specification [AEC-Q200]

1.Scope

This reference specification applies to Chip Ferrite Bead BLM18_□Z Series for Automotive Electronics based on AEC-Q200 except for Power train and Safety.

2.Part Numbering

(ex.) $\frac{BL}{(1)}$ $\frac{M}{(2)}$ $\frac{18}{(3)}$ $\frac{AG}{(4)}$ $\frac{121}{(5)}$ $\frac{S}{(6)}$ $\frac{Z}{(7)}$ $\frac{1}{(8)}$ $\frac{D}{(9)}$

(1)Product ID (4)Characteristics (7)Category(for Automotive Electronics)
 (2)Type (5)Typical Impedance at 100MHz (8)Numbers of Circuit
 (3)Dimension (L×W) (6)Performance (9)Packaging (D:Taping)

3.Rating

Customer Part Number	MURATA Part Number	Impedance (Ω) (at 100MHz)(*1) (refer to below comment)		Rated Current (mA)		DC Resistance (Ω max.) (*1) (refer to below comment)		Remark	ESD Rank 2:2kV
		Typical	at 85°C	at 125°C	Initial Values	Values After Testing			
	BLM18PG300SZ1D	20 min.	30	1000	0.05	0.10	For DC power line	2	
	BLM18PG330SZ1D	33±25%	33	3000*2 1000*2	0.025	0.050			
	BLM18PG600SZ1D	40 min.	60	1000	0.1	0.2			
	BLM18PG121SZ1D	120±25%	120	2000*2 1000*2	0.05	0.10			
	BLM18PG181SZ1D	180±25%	180	1500*2 1000*2	0.09	0.18			
	BLM18PG221SZ1D	220±25%	220	1400*2 1000*2	0.10	0.14			
	BLM18PG331SZ1D	330±25%	330	1200*2 1000*2	0.15	0.20			
	BLM18PG471SZ1D	470±25%	470	1000	0.20	0.26			
	BLM18SP300SZ1D	30±10	30	6000*1 4000*1	0.008	0.010			
	BLM18SP101SZ1D	100±25%	100	3700*1 2500*1	0.022	0.026			
	BLM18SP221SZ1D	220±25%	220	2800*1 1900*1	0.040	0.048			
	BLM18SP601SZ1D	600±25%	600	1500*1 1000*1	0.140	0.168			
	BLM18SP102SZ1D	1000±25%	1000	1200*1 800*1	0.185	0.222			
	BLM18KG221SZ1D	220±25%	220	2200*2 1500*2	0.050	0.060			
	BLM18KG331SZ1D	330±25%	330	1700*2 1200*2	0.080	0.095			
	BLM18KG471SZ1D	470±25%	470	1500*2 1000*2	0.130	0.145			
	BLM18KG601SZ1D	600±25%	600	1300*2 1000*2	0.150	0.165			
	BLM18KG102SZ1D	1000±25%	1000	1000*2 800*2	0.200	0.230			
	BLM18AG121SZ1D	120±25%	120	800	0.18	0.28	For general use		
	BLM18AG151SZ1D	150±25%	150	700	0.25	0.35			
	BLM18AG221SZ1D	220±25%	220	700	0.25	0.35			
	BLM18AG331SZ1D	330±25%	330	600	0.30	0.40			
	BLM18AG471SZ1D	470±25%	470	550	0.35	0.45			

Customer Part Number	MURATA Part Number	Impedance (Ω) (at 100MHz)(*1) (refer to below comment)		Rated Current (mA)		DC Resistance (Ω max.) (*1) (refer to below comment)		Remark	ESD Rank 2:2KV
						Initial Values	Values After Testing		
	BLM18AG601SZ1D	600±25%	600	500	0.38	0.48	For general use	2	
	BLM18AG102SZ1D	1000±25%	1000	450	0.50	0.60			
	BLM18BB050SZ1D	5±25%	5	800	0.05	0.10	For high speed signal line		
	BLM18BA050SZ1D	5±25%	5	500	0.2	0.3			
	BLM18BB100SZ1D	10±25%	10	700	0.10	0.20			
	BLM18BA100SZ1D	10±25%	10	500	0.25	0.35			
	BLM18BB220SZ1D	22±25%	22	700	0.20	0.30			
	BLM18BA220SZ1D	22±25%	22	500	0.35	0.45			
	BLM18BB470SZ1D	47±25%	47	600	0.25	0.35			
	BLM18BD470SZ1D	47±25%	47	500	0.3	0.4			
	BLM18BA470SZ1D	47±25%	47	300	0.55	0.65			
	BLM18BB600SZ1D	60±25%	60	600	0.25	0.35			
	BLM18BA750SZ1D	75±25%	75	300	0.70	0.80			
	BLM18BB750SZ1D	75±25%	75	600	0.30	0.40			
	BLM18BB121SZ1D	120±25%	120	550	0.30	0.40	For high speed signal line		
	BLM18BD121SZ1D	120±25%	120	300	0.4	0.5			
	BLM18BA121SZ1D	120±25%	120	200	0.9	1.0			
	BLM18BB141SZ1D	140±25%	140	500	0.35	0.45			
	BLM18BB151SZ1D	150±25%	150	450	0.37	0.47			
	BLM18BD151SZ1D	150±25%	150	300	0.4	0.5			
	BLM18BB221SZ1D	220±25%	220	450	0.45	0.55			
	BLM18BD221SZ1D	220±25%	220	250	0.45	0.55			
	BLM18BB331SZ1D	330±25%	330	400	0.58	0.68			
	BLM18BD331SZ1D	330±25%	330	250	0.5	0.6			
	BLM18BD421SZ1D	420±25%	420	250	0.55	0.65			
	BLM18BB471SZ1D	470±25%	470	300	0.85	0.95			
	BLM18BD471SZ1D	470±25%	470	250	0.55	0.65			
	BLM18BD601SZ1D	600±25%	600	200	0.65	0.75			
	BLM18BD102SZ1D	1000±25%	1000	200	0.85	0.95			
	BLM18BD152SZ1D	1500±25%	1500	150	1.2	1.3			
	BLM18BD182SZ1D	1800±25%	1800	150	1.5	1.6			
	BLM18BD222SZ1D	2200±25%	2200	150	1.5	1.6			
	BLM18BD252SZ1D	2500±25%	2500	150	1.5	1.6			
	BLM18SG260TZ1D	26±25%	26	6000*2	1000*2	0.007	0.012	For DC power line (Thin type)	
	BLM18SG700TZ1D	70±25%	70	4000*2	1000*2	0.020	0.030		
	BLM18SG121TZ1D	120±25%	120	3000*2	1000*2	0.025	0.035		
	BLM18SG221TZ1D	220±25%	220	2500*2	1000*2	0.040	0.055		
	BLM18SG331TZ1D	330±25%	330	1500*2	1000*2	0.070	0.085		
	BLM18SN220TZ1D	22±7%	22	8000*2	5000*2	0.004	0.005		
	BLM18KG260TZ1D	26±25%	26	6000*2	4000*2	0.007	0.012		
	BLM18KG300TZ1D	30±25%	30	5000*2	3300*2	0.010	0.015		
	BLM18KG700TZ1D	70±25%	70	3500*2	2200*2	0.022	0.032		
	BLM18KG101TZ1D	100±25%	100	3000*2	1900*2	0.030	0.040		
	BLM18KG121TZ1D	120±25%	120	3000*2	1900*2	0.030	0.040		

• Operating Temperature : -55°C to +125°C

• Storage Temperature : -55°C to +125°C

(*1)

Standard Testing Conditions

< Unless otherwise specified >
 Temperature : Ordinary Temp. (15 °C to 35 °C)
 Humidity : Ordinary Humidity (25%(RH) to 85%(RH))

< In case of doubt >
 Temperature : 20°C±2 °C
 Humidity : 60%(RH) to 70%(RH)
 Atmospheric pressure : 86kPa to 106kPa

(*2) In case of Rated current is more than 1A,
 Rated Current is derated as right figure
 depending on the operating temperature.

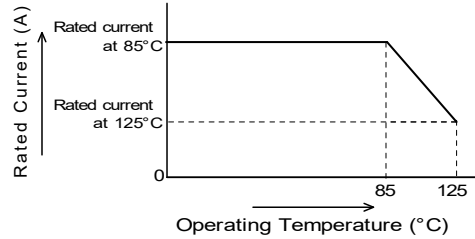

4.Style and Dimensions

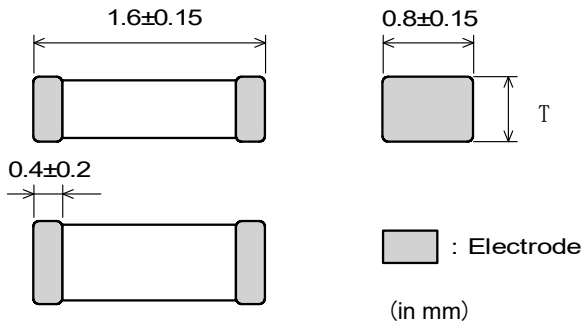

■ Equivalent Circuit

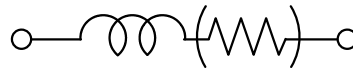

(Resistance element becomes dominant at high frequencies.)

■ Unit Mass (Typical value)

BLM18****TZ1D	0.004g
BLM18****SZ1D	0.005g

T	Model	Thickness (mm)
	BLM18SG***TZ1D	0.5±0.15
	BLM18KG***TZ1D	0.6±0.15
	BLM18SN***TZ1D	0.6±0.15
	BLM18****SZ1D	0.8±0.15

5.Marking

No marking.

6.Specifications

6-1.Electrical Performance

No.	Item	Specification	Test Method
6-1-1	Impedance	Meet item 3.	Measuring Frequency : 100MHz±1MHz Measuring Equipment : KEYSIGHT 4991A or the equivalent Test Fixture : KEYSIGHT 16192A or the equivalent
6-1-2	DC Resistance	Meet item 3.	Measuring Equipment : Digital multi meter For BLM18SN Measuring Equipment : YOKOGAWA 755611 or the equivalent Test Fixture : KEYSIGHT 16044A or the equivalent * Except resistance of the Substrate and Wire

6-2. Mechanical Performance(based on Table 13 for FILTER EMI SUPPRESSORS/FILTERS)

AEC-Q200 Rev.D issued June. 1 2010

AEC-Q200			Murata Specification / Deviation						
No.	Stress	Test Method							
3	High Temperature Exposure	1000hours at 125 deg C Set for 24hours at room temperature, then measured.	Meet Table A after testing. <u>Table A</u> <table border="1"> <tr> <td>Appearance</td> <td>No damage</td> </tr> <tr> <td>Impedance Change (at 100MHz)</td> <td>Within $\pm 30\%$ (for BLM18SN Within $\pm 50\%$)</td> </tr> <tr> <td>DC Resistance</td> <td>Meet item 3.</td> </tr> </table>	Appearance	No damage	Impedance Change (at 100MHz)	Within $\pm 30\%$ (for BLM18SN Within $\pm 50\%$)	DC Resistance	Meet item 3.
Appearance	No damage								
Impedance Change (at 100MHz)	Within $\pm 30\%$ (for BLM18SN Within $\pm 50\%$)								
DC Resistance	Meet item 3.								
4	Temperature Cycling	1000cycles -55 deg C to +125 deg C Set for 24hours at room temperature, then measured.	Meet Table B after testing. <u>Table B</u> <table border="1"> <tr> <td>Appearance</td> <td>No damage</td> </tr> <tr> <td>Impedance Change (at 100MHz)</td> <td>Within $\pm 30\%$ (for BLM18SN Within $\pm 50\%$) (for BLM18KG Within-10%to+50%)</td> </tr> <tr> <td>DC Resistance</td> <td>Meet item 3.</td> </tr> </table>	Appearance	No damage	Impedance Change (at 100MHz)	Within $\pm 30\%$ (for BLM18SN Within $\pm 50\%$) (for BLM18KG Within-10%to+50%)	DC Resistance	Meet item 3.
Appearance	No damage								
Impedance Change (at 100MHz)	Within $\pm 30\%$ (for BLM18SN Within $\pm 50\%$) (for BLM18KG Within-10%to+50%)								
DC Resistance	Meet item 3.								
5	Destructive Physical Analysis	Per EIA469 No electrical tests	No defects						
7	Biased Humidity	1000hours at 85 deg C, 85%RH Apply max rated current.	Meet Table C after testing. <u>Table C</u> <table border="1"> <tr> <td>Appearance</td> <td>No damage</td> </tr> <tr> <td>Impedance Change (at 100MHz)</td> <td>Within $\pm 30\%$ (for BLM18KG/SN Within $\pm 50\%$)</td> </tr> <tr> <td>DC Resistance</td> <td>Meet item 3.</td> </tr> </table>	Appearance	No damage	Impedance Change (at 100MHz)	Within $\pm 30\%$ (for BLM18KG/SN Within $\pm 50\%$)	DC Resistance	Meet item 3.
Appearance	No damage								
Impedance Change (at 100MHz)	Within $\pm 30\%$ (for BLM18KG/SN Within $\pm 50\%$)								
DC Resistance	Meet item 3.								
8	Operational Life	Apply 125 deg C 1000hours Set for 24hours at room temperature, then measured	Meet Table C after testing. If the rated current of parts exceed 1A, the operating temperature should be 85 deg C.						
9	External Visual	Visual inspection	No abnormalities						
10	Physical Dimension	Meet ITEM 4 (Style and Dimensions)	No defects						
12	Resistance to Solvents	Per MIL-STD-202 Method 215	Not Applicable						
13	Mechanical Shock	Per MIL-STD-202 Method 213 Condition F 1500g's (14.7N)/0.5ms/ Half sine	Meet Table D after testing. <u>Table D</u> <table border="1"> <tr> <td>Appearance</td> <td>No damage</td> </tr> <tr> <td>Impedance Change (at 100MHz)</td> <td>Within $\pm 30\%$</td> </tr> <tr> <td>DC Resistance</td> <td>Meet item 3.</td> </tr> </table>	Appearance	No damage	Impedance Change (at 100MHz)	Within $\pm 30\%$	DC Resistance	Meet item 3.
Appearance	No damage								
Impedance Change (at 100MHz)	Within $\pm 30\%$								
DC Resistance	Meet item 3.								
14	Vibration	5g's(0.049N) for 20 minutes, 12cycles each of 3 orientations Test from 10-2000Hz.	Meet Table D after testing.						
15	Resistance to Soldering Heat	Solder temperature 260C+/-5 deg C Immersion time 10s	Pre-heating:150C +/- 10 deg,60s to 90s Meet Table C after testing.						

AEC-Q200			Murata Specification / Deviation
No.	Stress	Test Method	
17	ESD	Per AEC-Q200-002	Meet Table D after testing. ESD Rank: Meet Item 3. (Rating)
18	Solderability	Per J-STD-002	Method b : Not Applicable 95% of the terminations is to be soldered.
19	Electrical Characterization	Measured : Impedance	No defects
20	Flammability	Per UL-94	Not Applicable
21	Board Flex	Epoxy-PCB(1.6mm) Deflection 2mm(min) 60s minimum holding tim	Meet Table C after testing.
22	Terminal Strength	Per AEC-Q200-006	No defects
30	Electrical Transient Conduction	Per ISO-7637-2	Not Applicable

7.Specification of Packaging

7-1.Appearance and Dimensions (8mm-wide paper tape)

Part Number	Type	Appearance and Dimensions							
BLM18PG***SZ1D BLM18SP***SZ1D BLM18AG***SZ1D BLM18B***SZ1D BLM18SN***TZ1D BLM18KG***Z1D	8mm- wide Paper tape 4mm-pitch	<table border="1"> <thead> <tr> <th>Item</th> <th>Dimension "a"</th> </tr> </thead> <tbody> <tr> <td>BLM18****SZ1D</td> <td>1.1 max.</td> </tr> <tr> <td>BLM18KG***TZ1D</td> <td rowspan="2">0.85 max.</td> </tr> <tr> <td>BLM18SN***TZ1D</td> </tr> </tbody> </table>	Item	Dimension "a"	BLM18****SZ1D	1.1 max.	BLM18KG***TZ1D	0.85 max.	BLM18SN***TZ1D
Item	Dimension "a"								
BLM18****SZ1D	1.1 max.								
BLM18KG***TZ1D	0.85 max.								
BLM18SN***TZ1D									
BLM18SG***TZ1D	8mm- wide Paper tape 2mm-pitch								

(in mm)

7-4. Specification of Outer Case

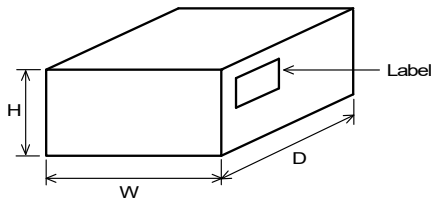

Outer Case Dimensions (mm)			Standard Reel Quantity in Outer Case (Reel)
W	D	H	
186	186	93	5

* Above Outer Case size is typical. It depends on a quantity of an order.

8. ⚠ Caution

8-1.Rating

Do not use products beyond the Operating Temperature Range and Rated Current.

8-2.Surge current

Excessive surge current (pulse current or rush current) than specified rated current applied to the product may cause a critical failure, such as an open circuit, burnout caused by excessive temperature rise. Please contact us in advance in case of applying the surge current.

8-3.Fail Safe

Be sure to provide an appropriate fail-safe function on your product to prevent from a second damage that may be caused by the abnormal function or the failure of our products.

8-4.Limitation of Applications

Please contact us before using our products for the applications listed below which require especially high reliability for the prevention of defects which might directly cause damage to the third party's life, body or property.

- (1)Aircraft equipment
- (2)Aerospace equipment
- (3)Undersea equipment
- (4)Power plant control equipment
- (5)Medical equipment
- (6)Disaster prevention / crime prevention equipment
- (7)Traffic signal equipment
- (8)Transportation equipment (trains,ships,etc.)
- (9)Data-processing equipment
- (10)Applications of similar complexity and /or reliability requirements to the applications listed in the above

9. Notice

This product is designed for solder mounting.

Please consult us in advance for applying other mounting method such as conductive adhesive.

9-1.Land pattern designing

- Standard land dimensions

< For BLM18 series (except BLM18P/BLM18S/BLM18K type) >

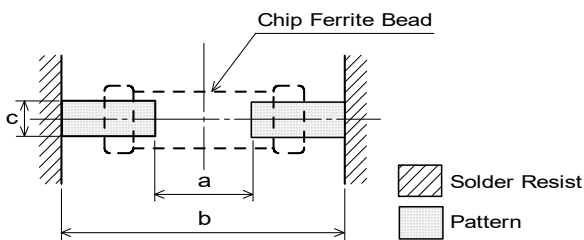

Type	Soldering	a	b	c
BLM18 (except 18P/18S/BLM18K type)	Flow	0.8	2.5	0.7
	Reflow	0.7	2.0	0.7

(in mm)

< For BLM18P/BLM18S/BLM18K type >

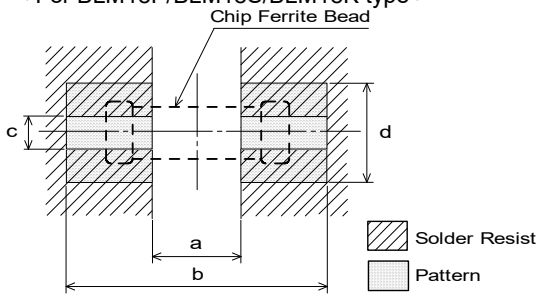

Type	Rated Current (A)	Soldering	a	b	c	Land pad thickness and dimension d		
						18μm	35μm	70μm
BLM18P	0.5 to 1.5	Flow/ Reflow	Flow 0.8 Reflow 0.7	Flow 2.5 Reflow 2.0	0.7	0.7	0.7	0.7
BLM18S	1.7 to 2.5					1.2	0.7	0.7
BLM18K	3 to 4					2.4	1.2	0.7
	5 to 6					6.4	3.3	1.65
BLM18SN	8					-	6.4	3.3
BLM18SP	1.2 to 6.0	-	6.4	-				

*The excessive heat by land pads may cause deterioration at joint of products with substrate.

(in mm)

9-2.Soldering Conditions

Products can be applied to reflow and flow soldering.

(1) Flux,Solder

Flux	Use rosin-based flux, but not highly acidic flux (with chlorine content exceeding 0.2(wt)%.) Do not use water-soluble flux.
Solder	Use Sn-3.0Ag-0.5Cu solder Standard thickness of solder paste : 100 μm to 200 μm

(2) Soldering conditions

- Pre-heating should be in such a way that the temperature difference between solder and ferrite surface is limited to 150°C max. Also cooling into solvent after soldering should be in such a way that the temperature difference is limited to 100°C max.
Insufficient pre-heating may cause cracks on the ferrite, resulting in the deterioration of product quality.
- Standard soldering profile and the limit soldering profile is as follows.
The excessive limit soldering conditions may cause leaching of the electrode and / or resulting in the deterioration of product quality.

(3)soldering profile

□Flow soldering profile

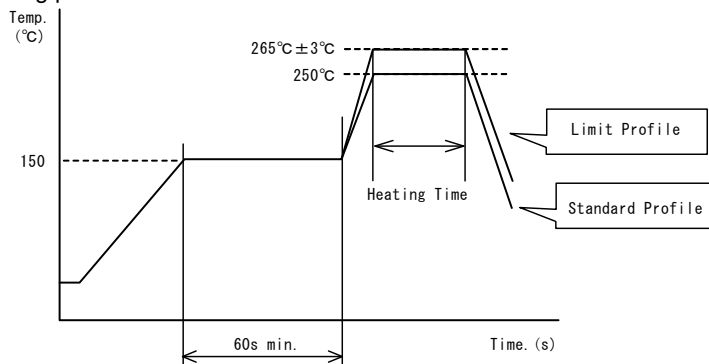

	Standard Profile	Limit Profile
Pre-heating	150°C、60s min.	
Heating	250°C、4~6s	265°C±3°C、5s max.
Cycle of flow	2 times	2 times

□Reflow soldering profile

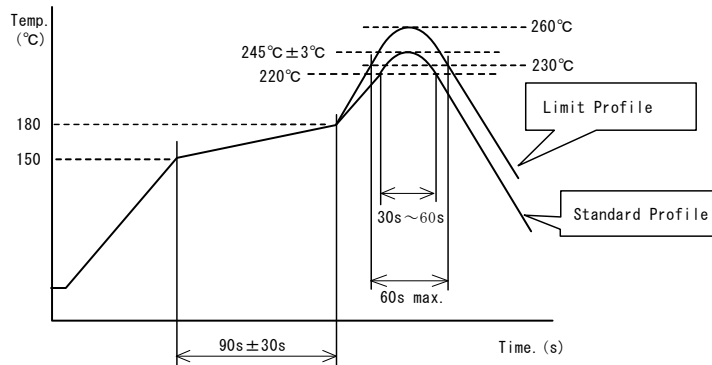

	Standard Profile	Limit Profile
Pre-heating	150~180°C、90s±30s	
Heating	above 220°C、30s~60s	above 230°C、60s max.
Peak temperature	245±3°C	260°C,10s
Cycle of reflow	2 times	2 times

9-3.Reworking with soldering iron

- Pre-heating: 150°C, 1 min
- Tip temperature: 350°C max.
- Soldering time : 3(+1,-0) seconds.
- Soldering iron output: 80W max.
- Tip diameter: φ 3mm max.
- Times : 2times max.

Note :Do not directly touch the products with the tip of the soldering iron in order to prevent the crack on the ferrite material due to the thermal shock.

9-4.Solder Volume

Solder shall be used not to be exceeded as shown below.

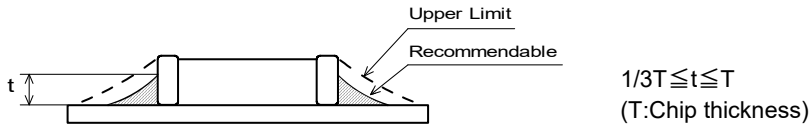

Accordingly increasing the solder volume, the mechanical stress to product is also increased. Exceeding solder volume may cause the failure of mechanical or electrical performance.

9-5.Attention regarding P.C.B. bending

The following shall be considered when designing and laying out P.C.B.'s.

(1) P.C.B. shall be designed so that products are not subject to the mechanical stress for board warpage.

<Products direction>

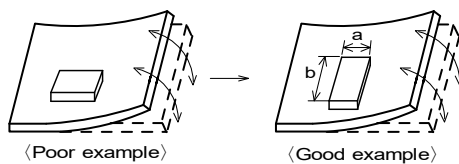

Products shall be located in the sideways direction (Length:a<b) to the mechanical stress.

(2)Components location on P.C.B. separation.

It is effective to implement the following measures, to reduce stress in separating the board.

It is best to implement all of the following three measures; however, implement as many measures as possible to reduce stress.

Contents of Measures	Stress Level
(1) Turn the mounting direction of the component parallel to the board separation surface.	A > D *1
(2) Add slits in the board separation part.	A > B
(3) Keep the mounting position of the component away from the board separation surface.	A > C

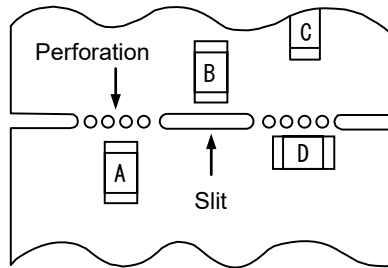

*1 A > D is valid when stress is added vertically to the perforation as with Hand Separation.
If a Cutting Disc is used, stress will be diagonal to the PCB, therefore A > D is invalid.

(3) Mounting Components Near Screw Holes

When a component is mounted near a screw hole, it may be affected by the board deflection that occurs during the tightening of the screw. Mount the component in a position as far away from the screw holes as possible.

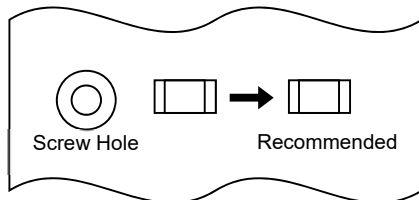

9-6. Mounting density

Add special attention to radiating heat of products when mounting the inductor near the products with heating. The excessive heat by other products may cause deterioration at joint of this product with substrate.

9-7. Operating Environment

Do not use this product under the following environmental conditions, on deterioration of the Insulation Resistance of the Ferrite material and/or corrosion of Inner Electrode may result from the use.

- (1) in the corrodible atmosphere such as acidic gases, alkaline gases, chlorine, sulfur gases, organic gases and etc. (the sea breeze, Cl₂, H₂S, NH₃, SO₂, NO₂, etc)
- (2) in the atmosphere where liquid such as organic solvent, may splash on the products.
- (3) in the atmosphere where the temperature / humidity changes rapidly and it is easy to dew.

9-8. Resin coating

The impedance value may change and/or it may affect on the product's performance due to high cure-stress of resin to be used for coating / molding products. So please pay your careful attention when you select resin. In prior to use, please make the reliability evaluation with the product mounted in your application set.

9-9. Cleaning Conditions

Products shall be cleaned on the following conditions.

- (1) Cleaning temperature shall be limited to 60°C max. (40°C max. for IPA.)
- (2) During ultrasonic cleaning, under some cleaning conditions, the resonance of PCB should be caused by its vibration. Be sure to do the test cleaning with actual cleaning equipment before production and confirm that product does not be damaged by cleaning.
- (3) Cleaner
 1. Alternative cleaner
 - Isopropyl alcohol (IPA)
 2. Aqueous agent
 - PINE ALPHA ST-100S
- (4) There shall be no residual flux and residual cleaner after cleaning.
In the case of using aqueous agent, products shall be dried completely after rinse with de-ionized water in order to remove the cleaner.
- (5) Other cleaning
Please contact us.

9-10. Handling of a substrate

After mounting products on a substrate, do not apply any stress to the product caused by bending or twisting to the substrate when cropping the substrate, inserting and removing a connector from the substrate or tightening screw to the substrate.

Excessive mechanical stress may cause cracking in the product.

Bending

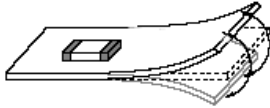

Twisting

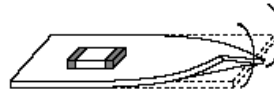

9-11. Storage Conditions

(1) Storage period

Use the products within 6 months after delivered.

Solderability should be checked if this period is exceeded.

(2) Storage conditions

- Products should be stored in the warehouse on the following conditions.

Temperature : -10°C to 40°C

Humidity : 15% to 85% relative humidity

No rapid change on temperature and humidity

- Don't keep products in corrosive gases such as sulfur, chlorine gas or acid, or it may cause oxidization of electrode, resulting in poor solderability.
- Products should be stored on the palette for the prevention of the influence from humidity, dust and so on.
- Products should be stored in the warehouse without heat shock, vibration, direct sunlight and so on.
- Products should be stored under the airtight packaged condition.

(3) Delivery

Care should be taken when transporting or handling product to avoid excessive vibration or mechanical shock.

10. Note

(1) Please make sure that your product has been evaluated in view of your specifications with our product being mounted to your product.

(2) You are requested not to use our product deviating from the reference specifications.

(3) The contents of this reference specification are subject to change without advance notice. Please approve our product specifications or transact the approval sheet for product specifications before ordering.