

APPLICATIONS

- Cell Phone Handsets and Accessories.
- Microprocessor based equipment.
- Personal Digital Assistants(PDA's)
- Notebooks Instrumentation.
- Peripherals.
- USB Interface.

MECHANICAL CHARACTERISTICS

- JEDEC SOD-323 Package.
- Molding Compound Flammability Rating: UL 94V-O.
- Weight 5 Milligrams (Approximate).
- Quantity per Reel: 3000pcs.
- Reel Size: 7inch.
- Lead Finish: Lead Free.

IEC COMPATIBILITY

- IEC61000-4-2(ESD) $\pm 15\text{KV}$ (air), $\pm 8\text{KV}$ (contact).
- IEC61000-4-4(EFT) 40A (5/50ns).
- IEC61000-4-5(Lightning) 12A (8/20 μs).

FEATURES

- 350 Watts Peak Pulse Power per Line ($t_p=8/20\mu\text{s}$).
- Protect one I/O lines (bidirectional).
- Low clamping voltage.
- Working voltages: 3V; 5V; 8V; 12V; 15V; 24V
- Low leakage current.

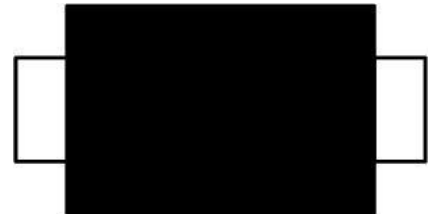

SOD-323

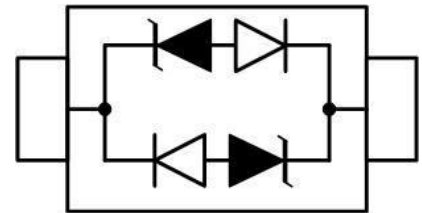

PIN CONFIGURATION

DEVICE CHARACTERISTICS

MAXIMUM RATINGS (@25°C Unless Otherwise Specified)			
PARAMETER	SYMBOL	VALUE	UNITS
Peak Pulse Power (tp=8/20μs waveform)	P _{PP}	350	Watts
Lead Soldering Temperature	T _L	260 (10sec)	°C
Operating Temperature Range	T _J	-55 to + 175	°C
Storage Temperature Range	T _{STG}	-55 to + 175	°C

ELECTRICAL CHARACTERISTICS PER LINE (@25°C Unless Otherwise Specified)

PART NUMBER	V _{RWM} (V) (max.)	V _B (V) (min.)	I _T (mA)	V _C (V) @5A (max.)	V _C (V) (max.)(@A)	I _R (μA) @ V _{RWM} (max.)	C _T (pF) (typ)
SB12DLC-B	12.0	13.3	1	19.00	28.6	6	1.5

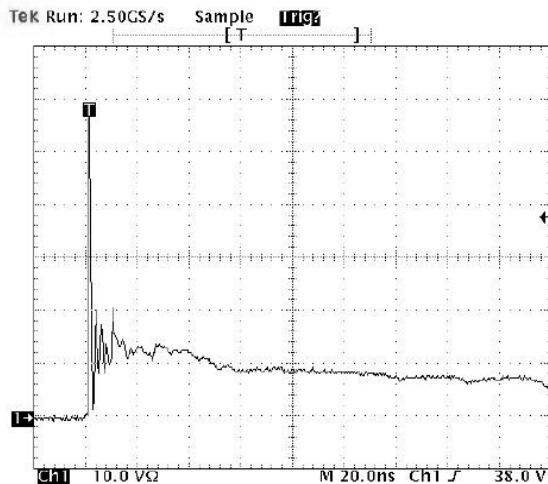

Figure 1. ESD Clamping Voltage Screenshot
Positive 8 kV contact per IEC 61000-4-2

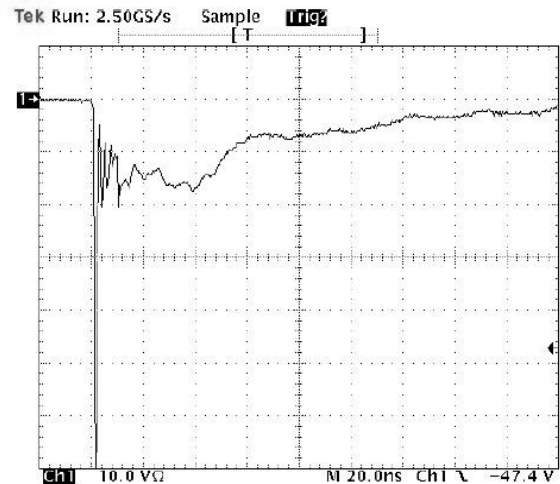
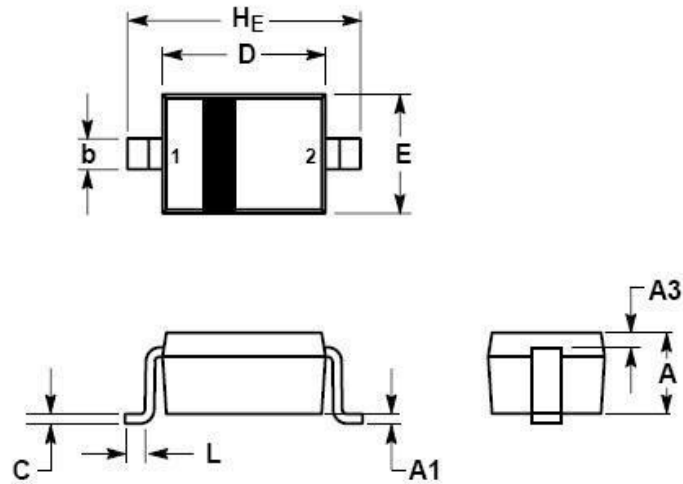

Figure 2. ESD Clamping Voltage Screenshot
Negative 8 kV contact per IEC 61000-4-2

SOD-323 PACKAGE OUTLINE & DIMENSIONS



DIM	MILLIMETERS			INCHES		
	MIN	NOM	MAX	MIN	NOM	MAX
A	0.80	0.90	1.00	0.031	0.035	0.040
A1	0.00	0.05	0.10	0.000	0.002	0.004
A3	0.15REF			0.006REF		
b	0.25	0.32	0.4	0.010	0.012	0.016
C	0.089	0.12	0.177	0.003	0.005	0.007
D	1.60	1.70	1.80	0.062	0.066	0.070
E	1.15	1.25	1.35	0.045	0.049	0.053
L	0.08			0.003		
H_E	2.30	2.50	2.70	0.090	0.098	0.105

SOD-323 EMBOSSED CARRIER TAPE

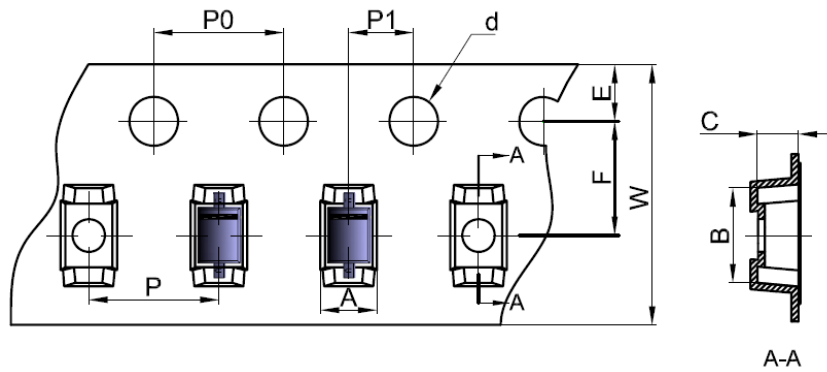

PKG TYPE	A	B	C	d	E	F	PO	P	P1	W
SOD-323	1.46	2.90	1.25	Φ1.50	1.75	3.50	4.00	4.00	2.00	8.00
TOLERANCE	±0.05	±0.05	±0.05	±0.10	±0.10	±0.10	±0.10	±0.10	±0.10	+0.3-0.1

TAPE LEADER AND TRAILER

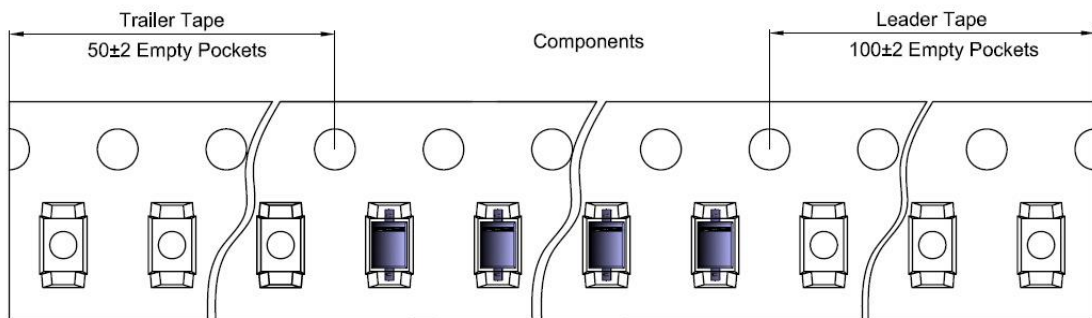

REEL

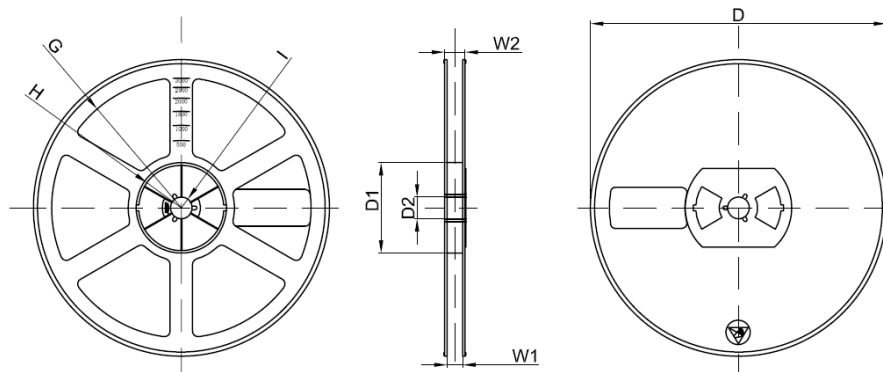

Dimension in Millimeter								
REEL OPTION	D	D1	D2	G	H	I	W1	W2
7" DIAMETION	Φ178	54.40	13.00	R78.0	R25.60	R6.50	9.50	12.30
TOLERANCE	±2	±1	±1	±1	±1	±1	±1	±1

SOLDERING FOOTPRINT

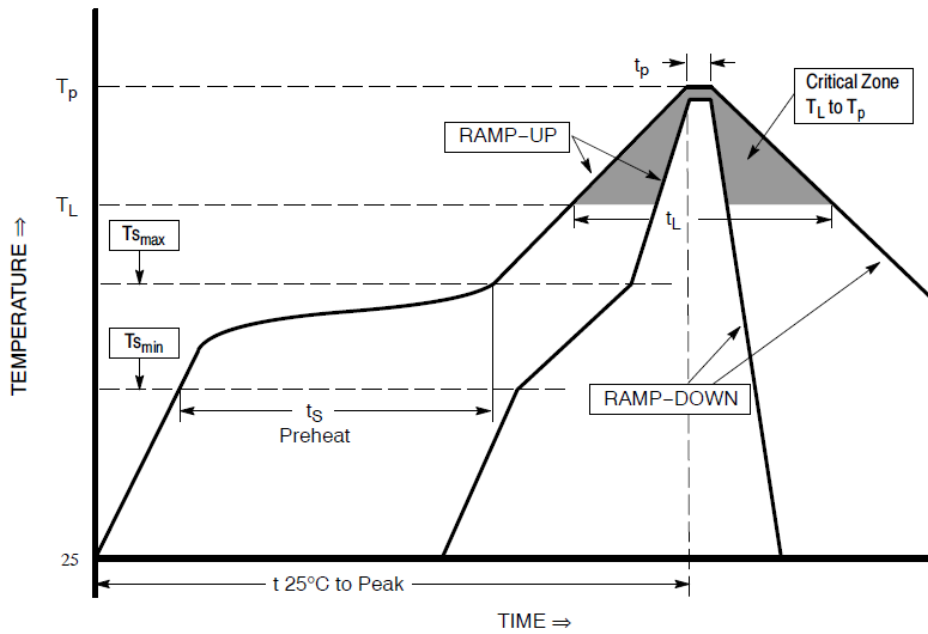
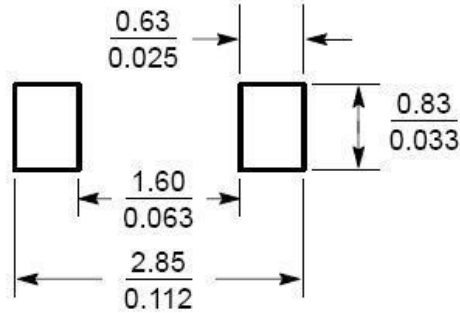

Profile Feature	Pb-Free Assembly
Average Ramp-Up Rate(T_{smax} to T_p)	3°C/Second max
Preheat	
Temperature Min(T_{smin})	150°C
Temperature Max(T_{smax})	200°C
Time(t_{smin} to t_{smax})	60-180 seconds
Time maintained above Temperature(T_t)	217°C
Time(t_T)	60-150 seconds
Peak Classification Temperature(T_p)	260°C +5/-0
Time within 5°C of actual Peak Temperature(t_p)	20-40seconds
Ramp-Down Rate	6°C /second max
Time 25°C to Peak Temperature	8 minutes max