

P-Channel Enhancement Mode Field Effect Transistor

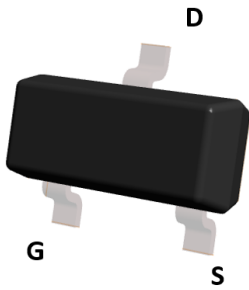

Top View

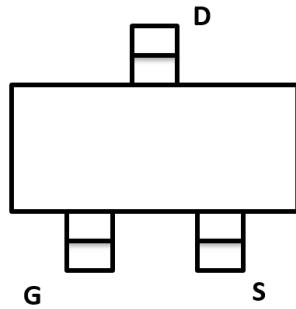

SOT-23-3L

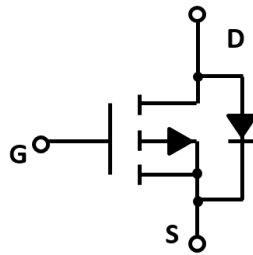

Product Summary

- V_{DS} -30V
- I_D -4.4A
- $R_{DS(ON)}$ (at $V_{GS}=-10V$) <55 mohm
- $R_{DS(ON)}$ (at $V_{GS}=-4.5V$) <68 mohm
- $R_{DS(ON)}$ (at $V_{GS}=-2.5V$) <96 mohm

General Description

- Trench Power LV MOSFET technology
- High density cell design for Low $R_{DS(ON)}$
- High Speed switching

Applications

- Battery protection
- Load switch
- Power management

■ Absolute Maximum Ratings ($T_A=25^\circ\text{C}$ unless otherwise noted)

| Parameter | Symbol | Maximum | Unit |
|--|-----------------|---------------------------------------|---------------------------|
| Drain-source Voltage | V_{DS} | -30 | V |
| Gate-source Voltage | V_{GS} | ± 12 | V |
| Drain Current | I_D | $T_A=25^\circ\text{C}$ @ Steady State | -4.4 |
| | | $T_A=70^\circ\text{C}$ @ Steady State | -3.5 |
| Pulsed Drain Current ^A | I_{DM} | -27 | A |
| Total Power Dissipation @ $T_A=25^\circ\text{C}$ | P_D | 1.5 | W |
| Thermal Resistance Junction-to-Ambient @ Steady State ^B | $R_{\theta JA}$ | 82 | $^\circ\text{C}/\text{W}$ |
| Junction and Storage Temperature Range | T_J, T_{STG} | -55~+150 | $^\circ\text{C}$ |

■ Ordering Information (Example)

| PREFERRED P/N | PACKING CODE | Marking | MINIMUM PACKAGE(pcs) | INNER BOX QUANTITY(pcs) | OUTER CARTON QUANTITY(pcs) | DELIVERY MODE |
|---------------|--------------|---------|----------------------|-------------------------|----------------------------|---------------|
| YJL3401AL | F1 | R1A. | 3000 | 30000 | 120000 | 7" reel |



YJL3401AL

■ Electrical Characteristics (T_J=25°C unless otherwise noted)

| Parameter | Symbol | Conditions | Min | Typ | Max | Units |
|---------------------------------------|---------------------|---|------|------|------|-------|
| Static Parameter | | | | | | |
| Drain-Source Breakdown Voltage | BV _{DSS} | V _{GS} =0V, I _D =-250μA | -30 | | | V |
| Zero Gate Voltage Drain Current | I _{DSS} | V _{DS} =-30V, V _{GS} =0V, T _C =25°C | | | -1 | μA |
| Gate-Body Leakage Current | I _{GSS} | V _{GS} = ±12V, V _{DS} =0V | | | ±100 | nA |
| Gate Threshold Voltage | V _{GS(th)} | V _{DS} = V _{GS} , I _D =-250μA | -0.6 | -0.9 | -1.4 | V |
| Static Drain-Source On-Resistance | R _{DS(ON)} | V _{GS} = -10V, I _D =-4.4A | | 45.5 | 55 | mΩ |
| | | V _{GS} = -4.5V, I _D =-3A | | 52 | 68 | |
| | | V _{GS} = -2.5V, I _D =-2A | | 64 | 96 | |
| Diode Forward Voltage | V _{SD} | I _S =-4.4A, V _{GS} =0V | | -0.8 | -1.2 | V |
| Maximum Body-Diode Continuous Current | I _S | | | | -4.4 | A |
| Dynamic Parameters | | | | | | |
| Input Capacitance | C _{iss} | V _{DS} =-15V, V _{GS} =0V, f=1MHZ | | 680 | | pF |
| Output Capacitance | C _{oss} | | | 105 | | |
| Reverse Transfer Capacitance | C _{rss} | | | 68 | | |
| Switching Parameters | | | | | | |
| Total Gate Charge | Q _g | V _{GS} =-10V, V _{DS} =-15V, I _D =-4.4A | | 7.2 | | nC |
| Gate Source Charge | Q _{gs} | | | 1.2 | | |
| Gate Drain Charge | Q _{gd} | | | 1.6 | | |
| Turn-on Delay Time | t _{D(on)} | V _{GS} =-10V, V _{DD} =-15V, I _D =-1A, R _{GEN} =2.5Ω | | 15 | | ns |
| Turn-on Rise Time | t _r | | | 63 | | |
| Turn-off Delay Time | t _{D(off)} | | | 21 | | |
| Turn-off Fall Time | t _f | | | 12 | | |

A. Pulse Test: Pulse Width ≤ 300us, Duty cycle ≤ 2%.

B. Device mounted on FR-4 PCB, 1 inch x 0.85 inch x 0.062 inch.



■ Typical Performance Characteristics

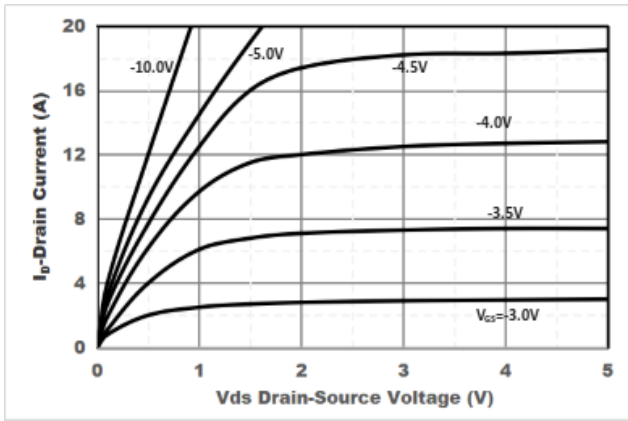

Figure1. Output Characteristics

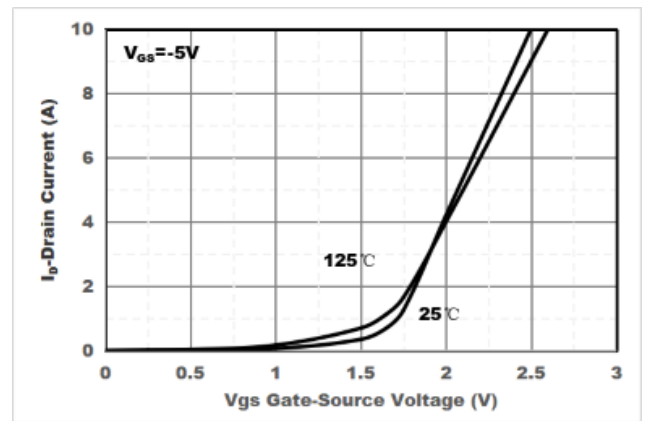

Figure2. Transfer Characteristics

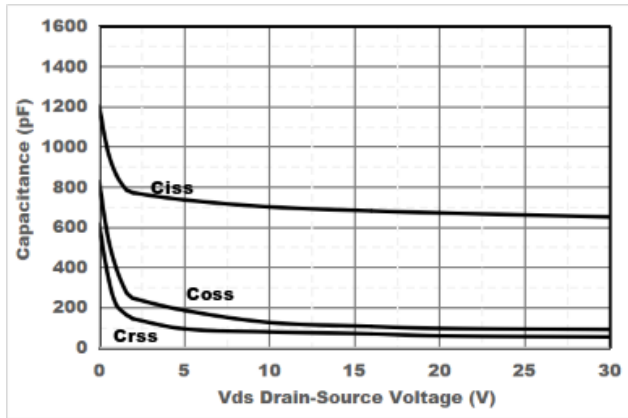

Figure3. Capacitance Characteristics

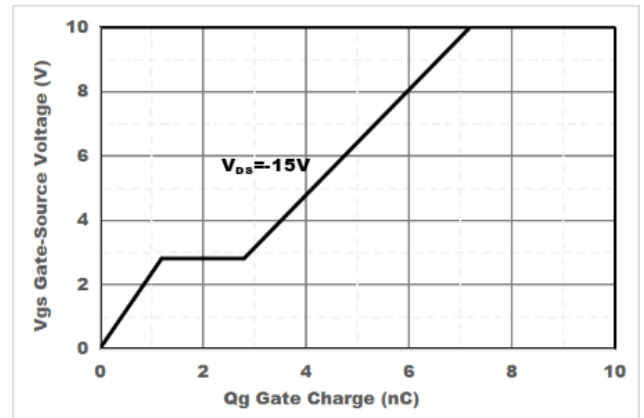

Figure4. Gate Charge

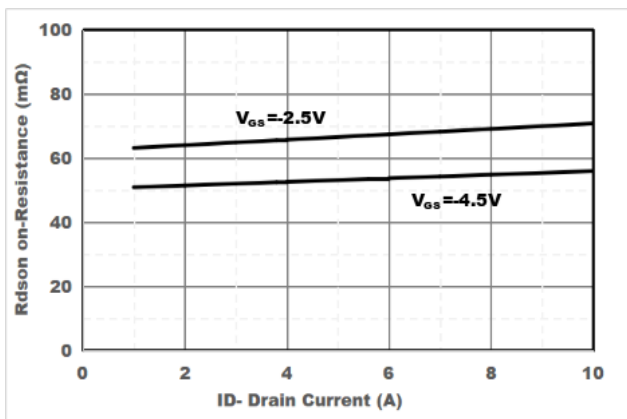

Figure5. Drain-Source on Resistance

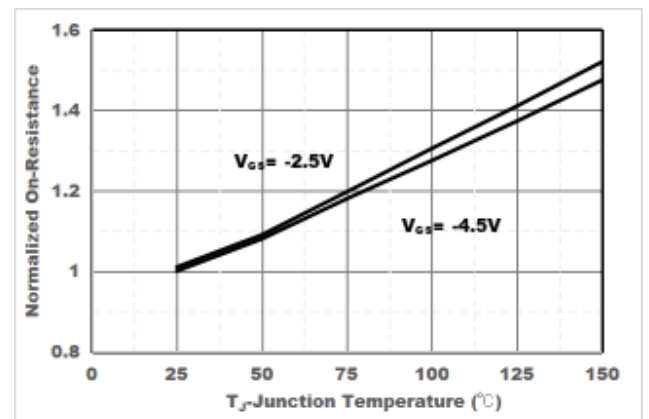

Figure6. Drain-Source on Resistance

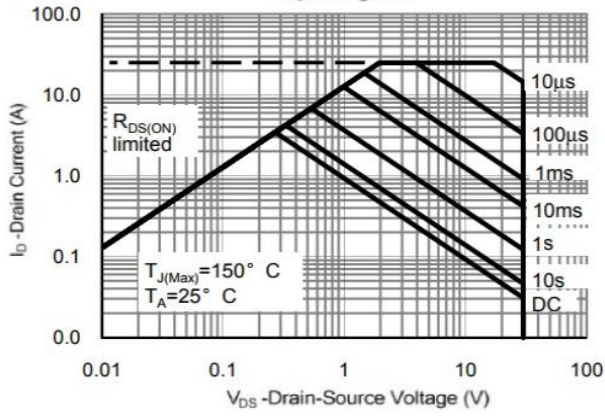

Figure7. Safe Operation Area

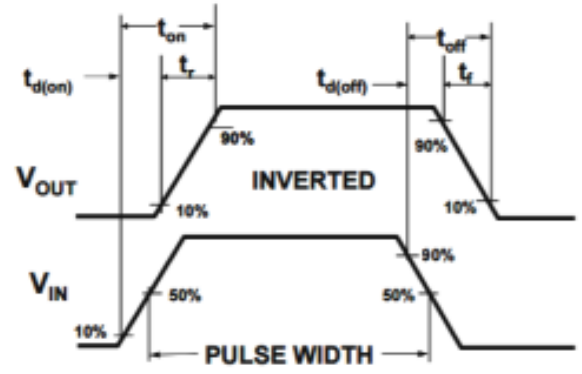
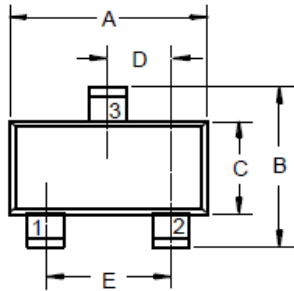

Figure8. Switching wave



■ SOT-23 Package information

SOT-23-3L



- 1. GATE
- 2. SOURCE
- 3. DRAIN

| DIM | INCHES | | MM | | NOTE |
|-----|--------|-------|------|------|------|
| | MIN | MAX | MIN | MAX | |
| A | .113 | .117 | 2.87 | 2.97 | |
| B | .108 | .112 | 2.75 | 2.85 | |
| C | .061 | .065 | 1.55 | 1.65 | |
| D | .036 | .038 | .914 | .965 | |
| E | .073 | .077 | 1.85 | 1.95 | |
| G | .0016 | .0039 | .04 | .100 | |
| H | .044 | .049 | 1.12 | 1.25 | |
| J | .006 | .007 | .14 | .17 | |
| K | .013 | .015 | .34 | .37 | |

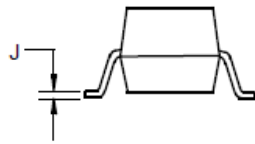
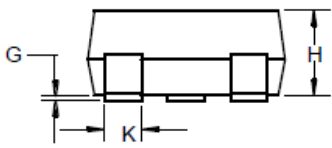

■ SOT-23 Suggested Pad Layout

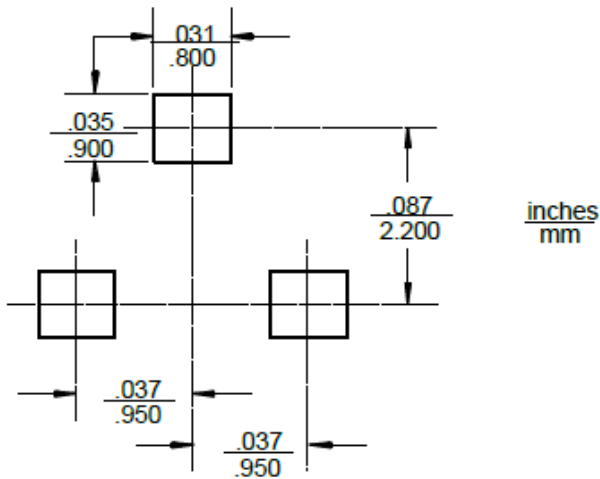



Disclaimer

The information presented in this document is for reference only. Yangzhou Yangjie Electronic Technology Co., Ltd. reserves the right to make changes without notice for the specification of the products displayed herein to improve reliability, function or design or otherwise.

The product listed herein is designed to be used with ordinary electronic equipment or devices, and not designed to be used with equipment or devices which require high level of reliability and the malfunction of which would directly endanger human life (such as medical instruments, transportation equipment, aerospace machinery, nuclear-reactor controllers, fuel controllers and other safety devices), Yangjie or anyone on its behalf, assumes no responsibility or liability for any damages resulting from such improper use of sale.

This publication supersedes & replaces all information previously supplied. For additional information, please visit our website [http:// www.21yangjie.com](http://www.21yangjie.com) , or consult your nearest Yangjie's sales office for further assistance.